

SEAT & FRAMING PLAN

1/4" = 1'-0"
42 NET SEATS @ 18" PER SEAT

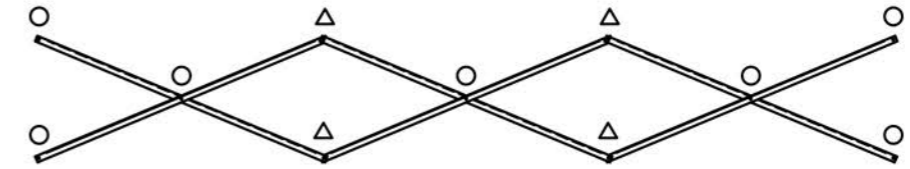

X-BRACE DETAIL

N.T.S.

- 7/16" X 1" GALV. MACH. BOLT
- △ 7/16" X 1.1/2" GALV. MACH. BOLT

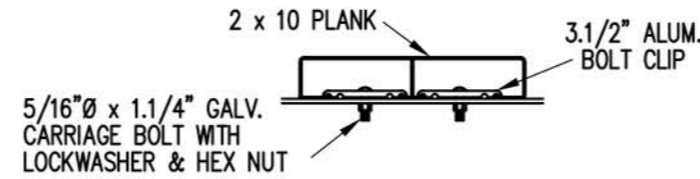

BOLT CLIP DETAIL

1.1/2" = 1'-0"



FIG.1

FIG.2

- 1) LOCATE THE CHANNEL END CAP AS SHOWN IN FIG. 1.
- 2) TAP END CAP INTO PLACE WITH RUBBER Mallet OR SOFT WOOD. FIG.2
- 3) DRILL 5/32" HOLES THROUGH THE BOTTOM FLANGE AND THE BOTTOM OUTSIDE PLANK FLANGES OF EACH PLANK. INSTALL 5/32" POP RIVETS.

END CAP DETAIL

N.T.S.

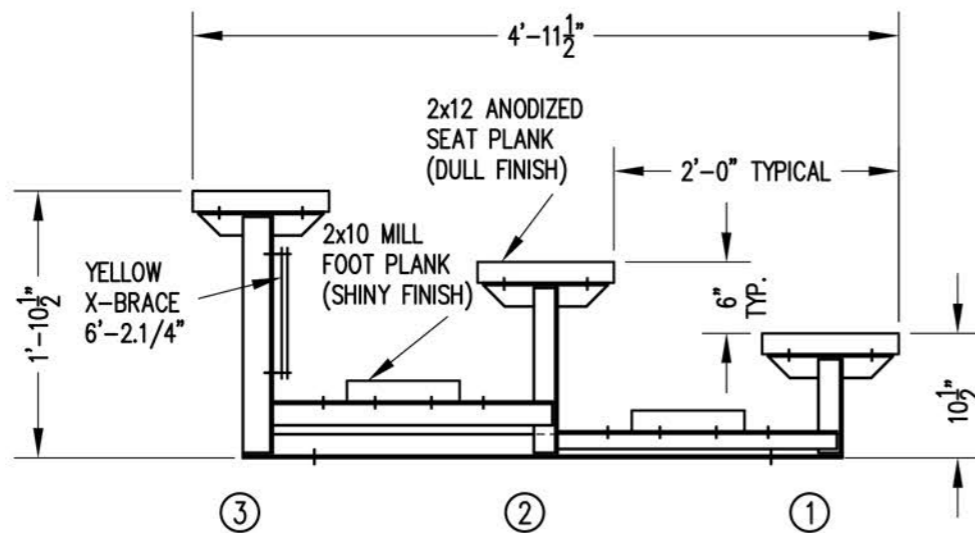

SECTION AA

3/4" = 1'-0"