

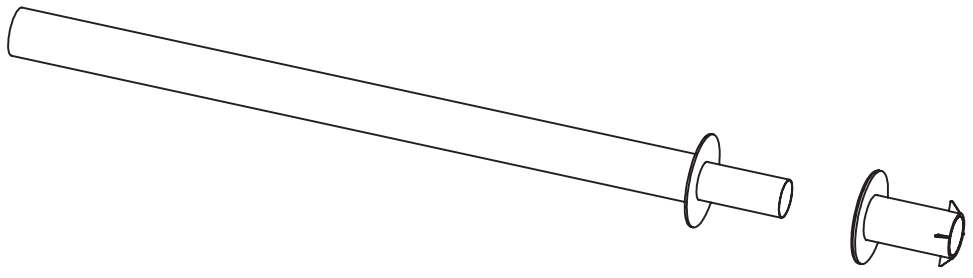



**INSTALLATION INSTRUCTIONS**  
REMOVABLE-BASE FLOOR MOUNT

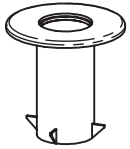

**PARTS LIST**

Required Tools	
 Goggles	 3 3/4" Dia. Hole Saw Drill

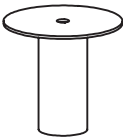
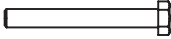
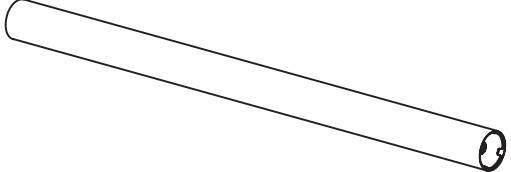
1	2	3	4	5
Floor Mount - Socket 	Floor Mount - Flush Cap 	Floor Mount - Plug Sleeve 	Hex Botl M12x90mm 	Post 

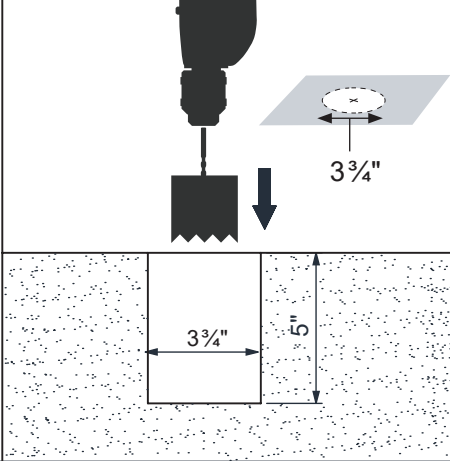
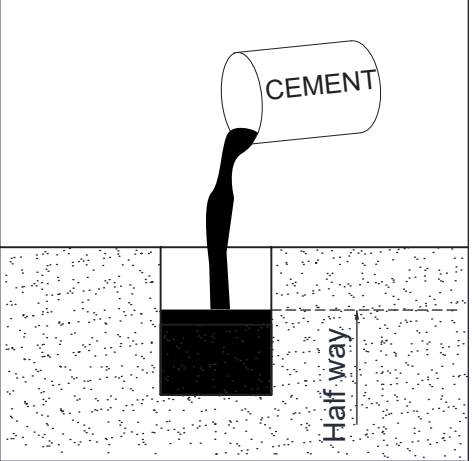
<p><b>STEP1:</b> Determine post location and mark floor for position. Using a 3 3/4" diameter Hole Saw, drill a hole 5" deep to allow floor socket to fit inside hole</p>		<p><b>STEP2:</b> Fill hole with cement halfway.</p>	
---	---	---	--

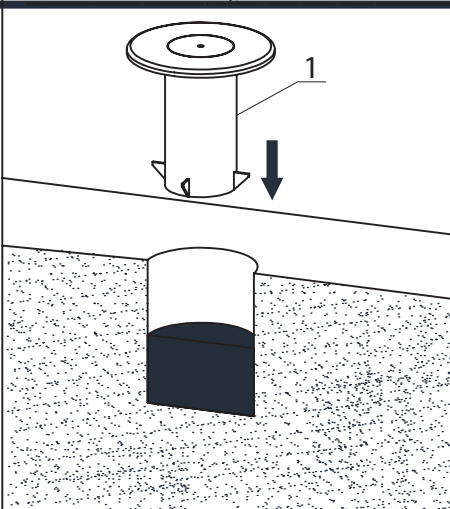
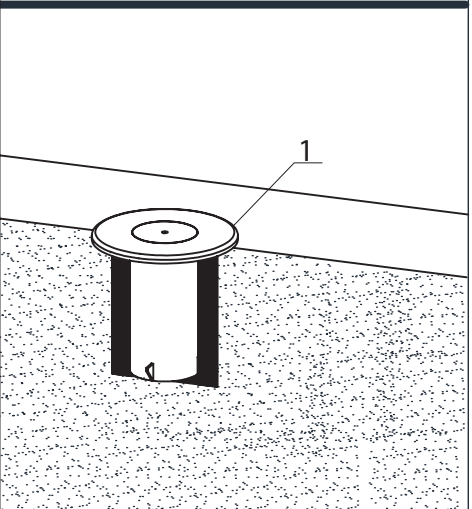
<p><b>STEP3:</b> Insert Floor Socket and wiggle it down until the bottom of the top plate is level with the ground.</p>		<p><b>STEP4:</b> Quickly clean any overflow cement.</p>	
---	--	---	---

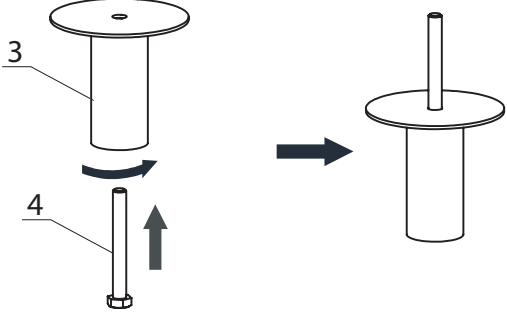
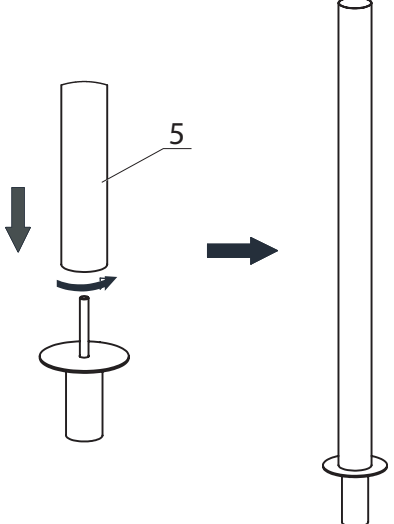
<p><b>STEP5:</b> Install Hex bolt into Plug Sleeve</p> 	<p><b>STEP6:</b> Install Post into Plug Sleeve</p> 
---	--

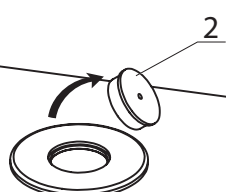
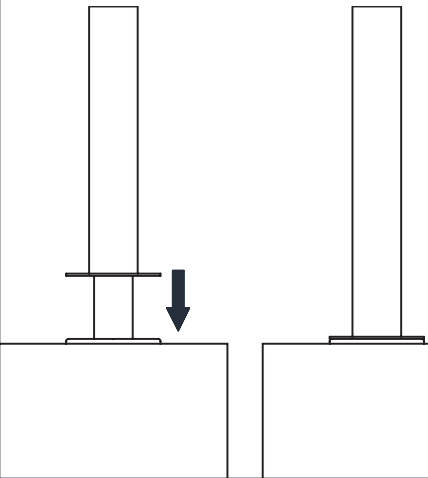
<p><b>STEP7:</b> Remove Flush Cap from Floor Socket</p> 	<p><b>STEP 8:</b> Allow cement to dry thoroughly before inserting post.</p> 
---	---