

Youshiko YC9415 RC Projection clock



One Step Automatic Set Up:

Connect Clock with power supply and insert required battery or activate the backup battery, wait for Projection Clock to **self set automatically** by MSF Radio control system, within few minutes to few hours or maximum by 05:00 am, depending on the signal or your location. (After this you never have to do anything, In some cases it may take up to 24H to self set everything.

Automatic time change for Spring & Autumn and automatic time checks, This also can take up to 24H to self set the time.

Keep the Clock display unit well away from TV / Computer / Wi-Fi Hub / Mobile phones etc to avoid any interference .

Please Note Before Using:

Every time Clock look for Radio control signal projection clock screen & projection time turns off for few minutes.

1. If the projection clock screen & projection time turns off when you turn the projection clock on, it's because it begins to calibrate time automatically based on local radio-controlled time, not because it's faulty. The screen will light up after it finish the auto time-calibration.
2. The loudness of alarm sound or ringtone cannot be adjusted.

Features:

- ▶ **MSF** Radio controlled clock function
- ▶ Perpetual calendar Up to Year 2099
- ▶ Day of week in ENGLISH
- ▶ Timing in optional 12/24 hour format.
- ▶ Dual alarms that can be set on weekdays / weekends and daily
- ▶ Snooze time setting (1~30Minute or OFF)
- ▶ Time and temperature projection function
- ▶ Projection display around 180 degree rotation function
- ▶ Maximum /minimum value record of temperature
- ▶ Indoor temperature measurement ranges: -9.9°C (14.2°F) ~ 50°C (122°F)
- ▶ Temperature alternatively in °C or °F
- ▶ Power Supply:

Battery: CR2032 (keep the time can go on after the external power supply is disconnected)

Adapter: DC5V1.2A

Production Appearance:

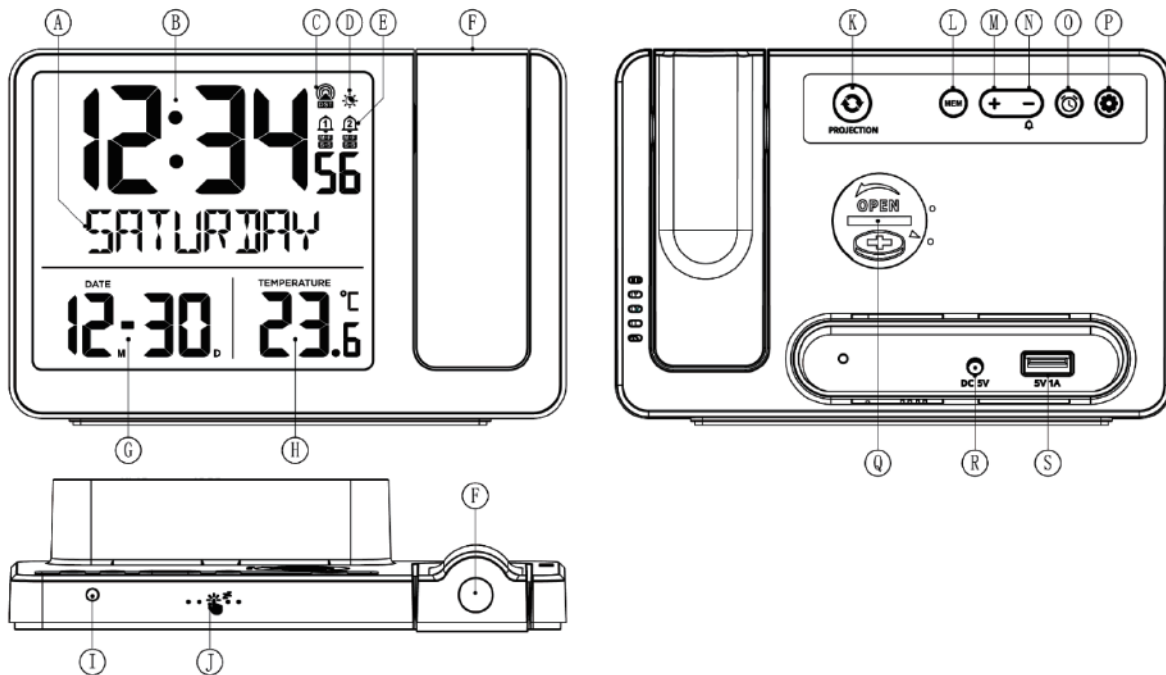

A: Day of week

B: TIME

C: Radio wave receiving status symbol

D: Automatic backlight brightness symbol

E: Alarm ON symbol

F: Projection window

G: DATE

H: Indoor temperature

I: Light sensor

J: SNOOZE /LIGHT button

K: Projection rotation/ON/OFF button

L: MEMORY button

M: + button

N: - / ALARM ON or OFF button

O: ALARM SET button

P: Manual setting time/date/backlight brightness button

Q: Battery cover

R: Adapter input socket

S: USB charging interface (MAX. 5V1A)

Initial operation

- ▶ Open the main unit battery compartment cover
- ▶ Insert CR2032 batteries observing polarity (“+” and “-” marks), If there is battery insulating sheet, just pull out the insulating sheet.
- ▶ Insert the output terminal of the adapter into the DC power socket on the back of the product, then insert the adapter into the AC socket (100~240V), the backlight of the product will always be lit.

Reception of the Radio signal

- ▶ The clock will automatically search the **MSF** signal after normal power supply operation, the symbol ▲ flashing indicates entering radio control reception mode, when a valid signal is identified, the symbol ▲ will not flash, and the symbol ☉ will flash.
- ▶ In standard mode, press and hold the button — for 3 seconds to entering radio control reception mode manually.

▶ At 1:00 /2:00 / 3:00 (A.M.), the production automatically carries out the synchronization procedure with the MSF signal to correct any deviations to the exact time. If this synchronization attempt is unsuccessful (the radio mast icon disappears from the display), the system will automatically attempt synchronization at the next full one hour. This procedure is repeated automatically up to total 5 times.

▶ During radio control reception, to stop searching radio wave signal, press the button  once.

 : Received successfully

 : The previous reception was successful, but the last reception failed

 : Radio control function is set to OFF

F.Y.I.:

- ▶ A flashing radio mast icon indicates that the **MSF** signal reception has started
- ▶ A continuously displayed radio mast icon indicates that the **MSF** signal was received successfully
- ▶ We recommend a minimum distance of 2.5 meters to all sources of interference, such as televisions or computer monitors
- ▶ **Radio reception is weaker in rooms with concrete walls (e.g.: in cellars) and in offices. In such extreme circumstances, place the system close to the window.**

▶ During the radio wave receive mode, only the "••••" and "—" button function, other button operation have no function, If you want to carry out other functions of operation, please press "—" button to exit the RC receiving mode.

▶ When receiving radio waves, the backlight and projection will be temporarily off, and the brightness will be restored after receiving.

Also please note : If you wish to have the date display in Day/ Month (UK format) , then this can be changed via manual time setting .

Manual time setting

▶ Press and hold the  button for 2 seconds, the Radio Control **ON/OFF** display starts to flash, and press the "+" or "—" buttons to set the Radio Control function is ON or OFF.

▶ Press the  button to confirm the item has been set and go to the next one, the sequence of setting items is as follows:

RCC ON/OFF → DST ON/OFF → 12/24Hr → HOUR → MINUTE → Format of DATE (D/M or M/D) → YEAR → MONTH → DATE → Temperature Unit

▶ When adjusting the value, press and hold the "+" or "—" button to adjust quickly.

▶ Press  button to confirm the last item to end the setting procedures, then it will return to the normal mode.



▶ When choosing the 12Hr format, if "AM" is displayed before the hours, it means that the hour is ante meridiem, if "PM" is displayed before the hours, it means that the hour is post meridiem.

F.Y.I.:

▶ If there is no valid operation within 20 seconds, it will automatically return to normal time mode from the set mode.

Alarm Setting

▶ Press button , you can set Alarm1 and Alarm2 ON or OFF, symbol  appear means that ALARM1 is ON, symbol  appear means that ALARM2 is ON, symbol  or  disappear means that Corresponding ALARM is OFF.

▶ Press once button , LCD display Alarm1 time (5 seconds), press button  again when Alarm1 time is displayed, LCD display Alarm2 time (5 seconds), press button  again when Alarm2 time is displayed, return to current time display.

▶ When Alarm1 time is displayed, press and hold button  for 2 seconds until Hour of the Alarm1 time starts to flash, press the + or — buttons to set the required Hour.

▶ Press button  to confirm the item has been set and go to the next one, the sequence of setting items is as follows:

Hour of Alarm1 → Minute of Alarm1 → repeat period of Alarm1 → Snooze time of Alarm1

▶ When setting the repeat period, comply with the following rules:

M-F (MON--FR): From Monday to Friday

S-S (SAT--SUN): From Saturday to Sunday

M-F S-S (MON--SUN): From Monday to Sunday

▶ The snooze time can be set to 1-30 minutes or OFF, if "OFF" is selected, it means that the snooze function is turned off.

▶ The Alarm2 time can be set according to the same method above.

F.Y.I.:

▶ If there is no valid operation within 20 seconds, it will automatically return to normal time mode from the alarm time set mode.

▶ When adjusting the value, press and hold the + or — button to adjust continuously and quickly

▶ The Alarm will sound for 2 minutes if you do not deactivate it by pressing any button.

Turn OFF the alarm sound

▶ When it's ringing, press any button except the **SNOOZE** button to stop the Alarm sound.

▶ When it's ringing, touch and hold the **SNOOZE** button for 2 seconds to stop the Alarm sound.

Snooze function

▶ When it's ringing, touch the **SNOOZE** button once the alarm sounds to get to snooze mode, when the set snooze time is over, it will ring again.





Query Maximum/minimum numerical value

- ▶ When the temperature is shown in the LCD, The main unit began to record temperature maximum and minimum numerical value.
- ▶ Press once "**MEM**" button, the LCD will display maximum value of temperature, The LCD will display the minimum value of temperature if press once "**MEM**" button again when the maximum value is displayed.
- ▶ At the same time, there are "**MAX**" or "**MIN**" displayed on the LCD.
- ▶ The temperature maximum/minimum value will RE records after press and hold "**MEM**" button 2 seconds.
- ▶ The memory value of the day will be automatically cleared at 0:00 every night.

F.Y.I.:

▶ If the temperature reading is below ranges, the **LL.L** will be displayed. If the temperature reading is above ranges, the **HH.H** will be displayed.

Backlight and Projection function

- ▶ Press and hold the button  for 2 seconds to switch between manual or automatic backlight adjustments modes.
- ▶ Default manual adjustment of backlight brightness after power on, When the automatic adjustment mode is switched, the symbol  is displayed.
- ▶ In the manual adjustment mode, press the  button to manually adjust the backlight brightness, press the button  to set the angle of the projection, press and hold the button  for 2 seconds to ON/OFF the projection.
- ▶ In the automatic adjustment mode, the product will detect the ambient brightness through the light sensor. When the environment is very bright, the backlight brightness is also bright. Because the ambient light is too strong, the projection will be automatically turned off. When the ambient brightness is dark, the backlight brightness will also be automatically dimmed, and the projection function will be automatically turned on.

USB charging interface: (MAX. 5V1A)

You can charge your mobile phone and other devices with the USB port , but keep your phone and other charging devices near the clock only when charging , as during charging time , mobile phones or other devices can block the RC signal.

F.Y.I.:

▶ When the projection is triggered, the projection distance is about 2 meters.

Keep this unit well away from heaters , Direct sun or water and cold walls.

Declaration of Conformity:

Youshiko Ltd hereby declares that the product fully complied to applicable guidelines and corresponding standards and requirements of UKCA and other relevant provisions of Directive 1999/5/EC. LIABILITY

DISCLAIMER:

Electrical and electronic waste contains hazardous substances. Disposal of electronic waste in open countryside and/or in other unauthorized places greatly damages the environment. • Please contact your local and/or regional authorities to find the addresses of legal dumping grounds with appropriate facilities. • All electronic instruments must now be recycled. Users shall take an active part in the recycling and recovery of electrical and electronic waste. The unrestricted disposal of electronic waste may do harm to public health and the quality of environment. • Reading the "User Manual" is highly recommended for the benefit of the user. This product must not be disposed of in general rubbish collection on facilities. • The manufacturer or supplier cannot accept any responsibility for any incorrect readings and any consequences that occur should an inaccurate reading take place. • This product is designed for use in the home or simple office only for the temperature and humidity etc. • This product is not to be used for medical purposes or for public information. • The specifications of this product may change without prior notice. • This product is not a toy, keep out of the reach of children. • No part of this manual may be reproduced without written authorization of the manufacturer.

Supplied in Box:

- 1 x Youshiko YC9415 Projection Clock main unit
- 1 x instruction manual
- 1 x CR2032 battery
- 1 x Power supply

All enquiries: service@youshiko.co.uk

