

# Youshiko YC9467 PROFESSIONAL WEATHER STATION



**Comes with the following:**

**1 x YC9467 Weather station Console ( Color Display unit ) + Power supply**

**1 x Outdoor Multi-combination Sensor with built in Solar Panel ( Model number : YC1120 )**

**1 x Sensor mounting kit**

**1 x User manual**

**Optional sensor Model no YC9318 : Additional temperature / humidity sensor ( shown above in picture ( sensor which is long and in black colour ) does not come with weather station package ) , but you can add up to 3 separate sensors , for temperature and humidity for 3 x different locations of your choice ) , these sensors can be purchased separately .**

# Features:

- ▶MSF Radio control time function
- ▶ Perpetual Calendar Up to Year 2099
- ▶Two daily alarms
- ▶ Automatic snooze function (OFF or 5~60min)
- ▶ Temperature:
  - Indoor temperature measurement ranges:0°C (32°F) to 50°C (122°F)
  - Outdoor temperature measurement ranges: -40°C (-40°F) to70°C (158°F)
- ▶ Humidity:
  - Indoor and outdoor humidity measurement ranges: 20% to 95%
- ▶ Air pressure:
  - Air pressure range: 600 to 1100 hPa (17.72 to 32.48 inHg or 450 to 825.1 mmHg)
- ▶ Rain
  - Rain range: 0 to 9999mm (0-393.6 inches)
- ▶ Wind
  - Wind speed range: 0 to 180 km/h (0 to 111 mph)
  - Wind direction range: 0 to 359 degrees
- ▶Wireless Outdoor Sensor:
  - 433.92MHz RF transmitting frequency
  - 100 meters (300 feet) transmission range in an open area, not including walls or floors.
- ▶Record of temperature, humidity, wind speed/ direction and rainfall
- ▶Alert of temperature, humidity, wind speed, rainfall
- ▶ Display of feels like temperature, wind chill temperature, heat index, dew point temperature
- ▶The weather forecasting function
- ▶ Level 3 display backlight
- ▶ USB charging function ( You charge your phone using this USB port )
- ▶ Power Supply:  
Weather station:  
Power Adapter: DC5V1.2A  
Battery: 2 x LR6 AA 1.5V  
Multi-combination Wireless Remote Sensor:  
Battery:3 x LR6 AA 1.5V

# Temperature | Humidity Wireless Remote Sensor ( Optional **sensor Model no : YC9318**)

Battery: 2 x LR6 AAA 1.5V

## **F.Y.I.:**

The wireless remote sensor can work at -30°C to +70°C. Please choose the right battery according to the limit temperature of the wireless sensor: Alkaline zinc manganese battery can work at -20°C to +60°C

Polymer lithium ion rechargeable batteries work at -40°C to +70°C.

## **Weather Station Appearance**

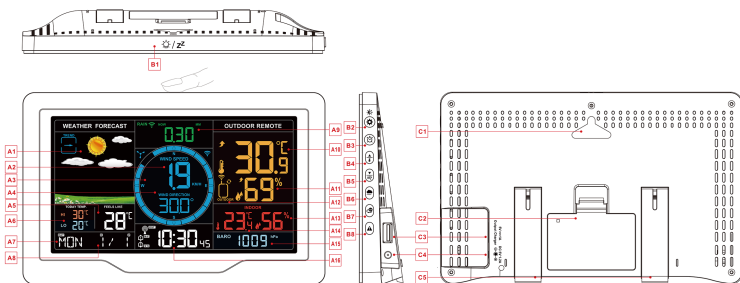

### **Part A-Positive LCD**

A1: Weather forecast

A3: Wind direction steering wheel

A5: Feels like temperature

A7: Day of the week

A9: Rainfall

A11: Outdoor humidity

A13: Indoor temperature

A2: Value of wind speed

A4: Wind direction or wind top speed of 1Hr

A6: Today's highest and lowest temperature record

A8: Calendar

A10: Outdoor temperature

A12: Outdoor wireless channel

A14: Indoor humidity

A15: Air pressure

 RCC Signal Icon

 DST Summer time icon

 Alarm 1 icon

 Alarm 2 icon

 M-F Monday-Friday repeat alarm icon



 S-S Saturday-Sunday repeat alarm icon



 Alarm snooze icon

 : Wireless receiving icon

 : Wireless channel loop icon

### Part B –Buttons

B1: “ / ” touch location

B2: “” and “” button

B3: “” button

B4: “” button

### Part C –Exterior

C1: Hanging hole

C3: USB charging socket

C5: Support frame

A16: Time

 : Battery low pressure icon

 HI High temperature alert icon

 LO Low temperature alert icon

 HI DAY 24-hour rainfall alert icon

 HI RATE Rainfall intensity alert icon

 HI TOP Top wind speed alert icon

 Wind icon

 Temperature | humidity up trend arrow

 Temperature | humidity down trend arrow

B5: “” button

B6: “” button

B7: “” button

B8: “” button

C2: Battery compartment

C4: Power supply socket

# Multi-combination Wireless Remote Sensor Appearance ( YC1120 )

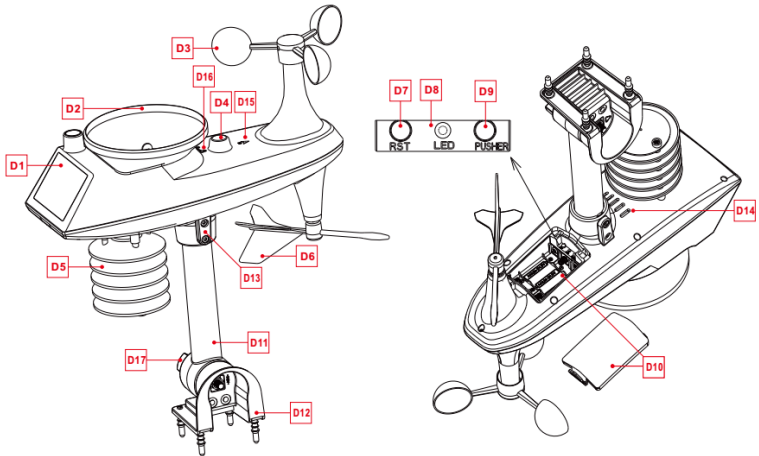

## Part D –Exterior

D1: Solar panel

D3: Wind cups

D5: Temperature | humidity induction box

D7: Reset button

D9: Manual transmit signal button

D11:Support rod

D13: Socket head cap screws

D15: North direction mark

D17: Large nut for fixing the support rod and the base

D2:Rain funnel

D4:Bubble level

D6: Wind Directional Vane

D8: LED indicator

D10: Battery compartment

D12: Fixed base

D14:Drain vents For rain sensor

D16: Rain funnel rotation mark

## Solar Panel:

Outdoor Sensor operating on dual-power. The solar power is only assisting the main batteries to prolong

the overall battery life.

During daytime under the sun,  
sensor is operating based on power  
directly coming from the solar panel.  
When the sun is set, Only after the AA  
batteries will kick in.

Please note : Solar panel does not  
charge batteries .

## Optional: sensor Model no: YC9318 Temperature | Humidity Wireless Remote Sensor Appearance

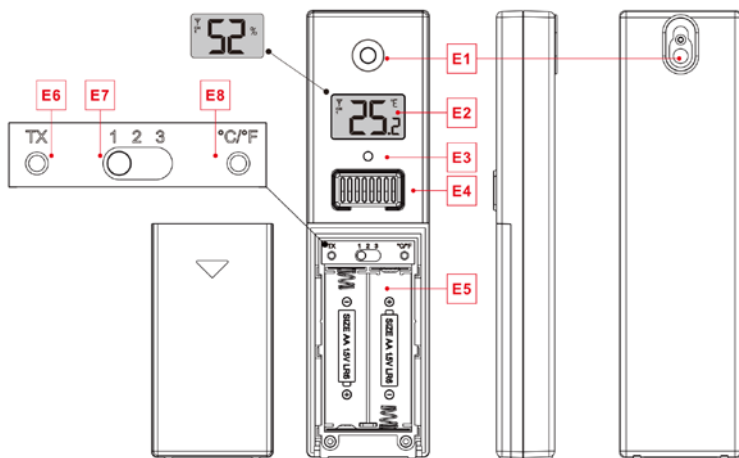

### Part E –Exterior

E1: Hanging hole

E3: LED indicator

E5: Battery compartment

E2: LCD display

E4: Temperature | Humidity sensing  
louver

E6: Manual transmit signal button “TX”

E7: "CHANNEL 1 or 2 or 3" switch

E8: Temperature | Humidity selection button

### ***Before set up***

#### ***For best results:***

- Remove weather station and sensors from the package and place together on a table or bench, within easy reach.
- Keep sensors and weather station 2 to 10 feet for at least 15 minutes after installing batteries and power supply to allow the sensors and station to connect repeatedly.

## **Setup Preparation**

Items you will need to setup your station (not included):

New Batteries:

2 (two) AA alkaline or lithium batteries for the weather station.

3 (three) AA alkaline or lithium batteries for the multi-combination sensor.

For **Optional sensor Model no YC9318**

2 (two) AA alkaline or lithium batteries for the temperature | humidity sensor (Optional)

### **Easy Installation :**

This weather station is very easy to set , as it will self set Automatically , all user have to do is insert batteries in the **Outdoor Multi-combination Sensor** and power up the weather station display unit with power supply , , then sensor will connect to display unit , ( If it does not , then simply press reset button on sensor , which you can find under the battery cover ) .

Also if you have **Optional sensor Model no YC9318, Additional temperature / humidity sensor or sensors , then choose CH number on the sensor and insert batteries in sensor , That is soon after you insert batteries in Outdoor Multi-combination Sensor.**



After powering on the weather station, ( after or around 3 minutes) will automatically enter the RCC timing mode. it will soon activate Radio Control Clock ( MSF UK & Ireland ). During the process, the display screen will automatically turn off to reduce other interference. After the process (in 7 minutes), the screen will light up again. Every night, at 1:00 am, 2:00 am, 3:00 am, it will start Radio Control , If the signal reception of Radio control signal fails due to signal interference or weak signal, it will start again at 4:00 am. If fails again, then it will , start again at 5:00 am. After 5:00 am, whether successful or not, it will not automatically start Radio Control . During the Radio Control process ( in 7 minutes ), if you want to light up the screen, please press “SNOOZE”, a t the same time RCC ( Radio Control Clock ) will continue. If you want to stop RCC, please press “Up”, RCC will stop and the screen will light up. If you want to activate RCC manually, please hold “Up” for 2-3 seconds, the station will start RCC.

Please note: in some areas, it can take up to 24H to find the RC signal, and every time it look for RC signal , screen will go dim,

It's very important to follow the instructions written on the back of display unit.

## Quick Setup





1. Insert 3 AA batteries into the multi-combination wireless remote sensor
- 2.3-AA battery entry temperature | humidity wireless remote sensor (**Optional sensor Model no YC9318** )
3. Then plug the power cord into the weather station
4. Configure basic settings. Set time, date, unit, etc.
5. Insert 2 AA batteries into the weather station (when the power adapter is unexpectedly powered off, the settings will not be lost)
6. Move the remote sensor to outdoor or other location after 5 minutes
7. Move the weather station to the appropriate location, with a minimum distance of 2.5 meters from all sources of interference, such as a television or computer monitor, radio reception is weaker in rooms with concrete walls (e.g.: in cellars) and in offices. In

such extreme circumstances, place the weather station close to the window.

**Note:** The weather station has a radio control clock calibration time function. After power-on, after searching the wireless sensor for 3 minutes or all channels successfully search for the wireless sensor, the weather station will automatically enter the radio control clock timing mode. If you need to set the time and unit manually, you need to press and hold the "" button to exit the radio time mode, and then continue to the next step.

## Time and unit settings

▶ Press and hold the "" button for 3 seconds to enter the time setting mode.

▶ Press and release the "" or "" button to adjust the value. Hold the "" or "" button to adjust quickly.

▶ Press and release the "" button to confirm and move to the next item.

**Note:** After 20 seconds without pressing any button or touch the " / ZZ" location button at any time to exit the settings.

## Settings order:

1. BEEP ON/OFF
2. Temperature unit: °C | °F
3. Pressure unit: hPa | inHg | mmHg
4. Wind speed unit: KM/H | MPH
5. Wind degree (angle) or direction (letter) selection
6. Rainfall unit: MM | inch
7. Radio control clock function: ON | OFF
8. Hour format: 24Hr | 12Hr
9. Hour
10. minutes
11. Calendar display format: Month/Date | Date/Month
12. Year
13. Month
14. Date
15. Initialize weather settings

**Note:** Exceeding the British signal tower diameter of 1500KM or more, the signal received by the radio clock signal is very poor. It is recommended to set the RCC to OFF.

## Radio control clock (Abbreviation: RCC) timing:

▶After the weather station searches for the wireless sensor after power-on, (up to 3 minutes) will automatically enter the RCC timing mode. The weather station will automatically search for the RCC signal for 7 minutes, **the RCC signal RC icon will flash and the backlight will automatically turn off.**

**Note:** Enter the RCC signal search mode. Since the RCC signal search requires the device to be in a static working state as much as possible, the backlight is automatically turned off to prevent signal interference. Please try not to control the weather station within seven minutes. If you need to exit the search mode of the RCC signal, press and hold the “” button for 3 seconds to exit.

▶The weather station will automatically perform an RCC signal search at 1:00 / 2:00 / 3:00 every day to correct any deviation from the precise time. If this sync attempt is unsuccessful (the radio mast icon disappears from the display), the system will automatically try another sync for the next full hour. This process is automatically repeated up to 5 times a day.



▶If you need to manually search for RCC signals, press and hold the “” button for 3 seconds to enter the search mode. Again, the longest search is 7 minutes.

**Note:** The flashing radio mast icon indicates that the RCC signal search is in progress. Continuous display of the continuously displayed radio mast icon indicates that the successful RCC signal timing is completed and the calibration time is successful. The icon “DST” indicates that the calibration time is the daylight saving time.

## Alarm function control

▶Press and release the “” button to view the alarm 1 time, press and release the button to view the alarm 2 time, the third release and release the button to exit the viewing mode.

▶In the mode of viewing the alarm 1 time or the alarm 2 time, press and release the “” button to control its alarm function to be turned on or off.

**Note:**When the function of Alarm 1 or Alarm 2 is turned on, the symbol “” or “” is displayed. At the same time, the relevant alarm repeat symbol “**M-F**” | “**S-S**” is displayed

**Note:** After 20 seconds without pressing any button or touch the “☀️ / ZZ” location button at any timeto exit the view mode.

## Alarm and Snooze settings

▶ Press and hold the “🕒” button for 3 seconds to enter the alarm and snooze setting mode.

▶ Press and release the “⬆️” or “⬇️” button to adjust the value. Hold the “⬆️” or “⬇️” button to adjust quickly.

▶ Press and release the “🕒” button to confirm and move to the next item.

**Note:** After 20 seconds without pressing any button or touch the “☀️ / ZZ” location button at any timeto exit the settings.

### Settings order:

1. Alarm 1 hour
2. Alarm 1 minutes
3. Alarm 1 repeat: M-F | S-S | M-S
4. Alarm 1 snooze time: 5 to 60minutes | OFF
5. Alarm 2 hour
6. Alarm 2 minutes
7. Alarm 2repeat: M-F | S-S | M-S
8. Alarm 2 snooze time: 5 to 60minutes | OFF

**Note:** The alarm is repeatedly set to M-F, the alarm function will be activated from Monday to Friday, the Saturday and Sunday will be invalid. The alarm is repeatedly set to S-S, and the alarm function will be activated on Saturday and Sunday, and will expire from Monday to Friday. When the alarm is repeatedly set to display both M-F and S-S, the alarm function will be activated throughout the week.

**Note:** The snooze time setting range: 5 ~ 60 MIN, OFF, when set to OFF, means no snooze function. Snooze time unit is minutes.

**Note:** The alarm will sound for 1 minutes if you do not deactivate it by pressing any button. In this case the alarm will be repeated automatically after 24 hours.

**Note:** Rising alarm sound (crescendo, duration: 2 minutes) changes the volume 4 times whilst the alarm signal is heard.

## Switching off the alarm signal

▶ The alarm sounds when the trigger is pressed, press any button except the “☀️ / ZZ” touch button or touch and hold the “☀️ / ZZ” button for more than 3 seconds to stop the alarm signal.

### Snooze function:

▶ When the time is up to the alarm, touch and release the “☀️ / ZZ” touch button, the alarm signal stops, and enter the snooze timing mode. At the end of the snooze timer, it will ring again (can repeat snooze)

▶ In snooze timing mode, press any buttons except the “☀️ / ZZ” touch button or touch hold down the “☀️ / ZZ” touch button for more than 3 seconds to exit the snooze mode

## Temperature | Humidity Readings | History | Trend

▶ Press and release the “⬆️” button to view High | Low temperature and humidity and feels like temperature, dew point temperature, heat index, wind chill index.

▶ In the view High | Low temperature or humidity mode, press and release the “CH” button to switch to view the records of other channels.

**Note:** feels like temperature, dew point temperature, heat index and wind chill index is related to the value detected by the multi-combined wireless remote sensor.

▶ In the mode of viewing temperature | Humidity history, press and hold the “⚙️” button for 3 seconds to clear all history of indoor | outdoor remote temperature | Humidity.

**Note:** Indoor | outdoor remote temperature | Humidity reading will reset to current value.

**Note:** After 20 seconds without pressing any button or touch the “☀️ / ZZ” location button at any time to exit the view mode.

▶ Indoor | outdoor remote temperature | humidity will have trend change tips

⬆️ : Temperature / humidity is rising.

⬇️ : Temperature/humidity drops.

No display: temperature/humidity remains unchanged.

## Wind Readings | History

▶ In the main display interface, press and hold the “⬇️” button for 3 seconds to convert

the display to wind direction or display as 1 hour top speed

**Note:** WIND SPEED: average speed over the past 30 seconds

1HR TOP SPEED: Highest speed in the past hour

WIND DIRECTION: In letters or degrees

**Note:** The conversion is displayed as a wind direction display or 1 hour top speed can only be operated under the main display interface.

▶View history: Press and release the “” button to view the maximum wind history values:1 Hour (default) | 24 Hour | 7 Days | Month | Year

**Note:** One Hour: past 60 minute period (default Top Speed record, already shown)

24 hour: Past 24 hour period, from last record

7 Days: Past 7-day period, from last record

Month: Defined by Calendar Month i.e. January 1 - January 31

Year: Defined by Calendar Year i.e. January 1 - December 31

▶In the mode of viewing wind speed history, press and hold the “” button for 3 seconds to clear all history of wind speed.

**Note:** Wind speed reading will reset to current wind speed.

**Note:** After 20 seconds without pressing any button or touch the “ / ZZ” location button at any timeto exit the view mode.

## Rain Readings | History

▶In the main display interface, press and hold the “” button for 3 secondsto convert the display to cumulative value of rainfall or rate of rainfall

**Note:** Rainfall: from current to past (1 hour | 24 hours | day | 7 days | month | year | total) total accumulated rainfall

Rainfall rate: average rainfall over the past 12 hours per hour

▶Press and release the “” button to view the rain history

**Note:** NOW: cumulative value over the past 30 minutes

HOUR: cumulative value over the past 60 minutes

24 HOURS: The cumulative value of the past 24 hours.

DAY: 24 hr period from 0:00 – 23:59(12:00am - 11:59pm). Cumulative value with today

7 DAYS: In the past 7 days, the cumulative value of the last record begins

MONTH: The cumulative value defined by the calendar month (ie January 1st - January 31st).

YEAR: The cumulative value is determined by the calendar year, from January 1 to

December 31.

**TOTAL:** The cumulative value of the total run time (no time stamp) since the weather station was started

▶ In the mode of viewing rain history, press and hold the “” button for 3 seconds to clear all history of rain.

**Note:** The rain reading will reset to 0mm(in).

**Note:** After 20 seconds without pressing any button or touch the “ / Z” location button at any time to exit the view mode, The weather station will resume normal time display and display the last rainfall record you viewed. When the rain shows the rain rate before entering the observation mode, it still shows the rain rate when returning from the observation mode to the normal time display.

## Wireless sensor connection

▶ The weather station can connect up to 1 Multi-combination wireless sensor and 3 different channels of temperature | humidity wireless sensor,

▶ The weather station automatically searches for all wireless sensors within 3 minutes of power-on and registers the sensor IDs. Each sensor generates a random ID after power-on to distinguish the sensors.

▶ In the main display interface, press and release the “” button to view the value of the wireless sensor on the different channels.

**Note:** In view mode, the ID of the wireless sensor can be displayed.

▶ The temperature/humidity data of the additional channel wireless sensor needs to be displayed on the normal time display interface. After selecting the channel in the viewing mode, touch the “ / Z” location button to exit the viewing mode.

**Note:** The temperature and humidity values shown in the OUTDOOR REMOTE column after exit are the selected channels. At the same time, in the channel icon (displaying the position of A15), the number of channels is displayed: OUTDOOR (representing Multi-combination wireless sensor) | 1 or 2 or 3 (representing 3 channels of temperature | humidity wireless sensor))

**Note:** When the weather station loses sensor signals or the sensor is not connected to the channel, the value of the channel is displayed as “--”

▶ If you need to add a new sensor or replace the sensor. In channel view mode, press and hold the “” button for more than 3 seconds, the weather station will search for the 3 minute signal again, and the new channel sensor will be added to the weather

station within 3 minutes.



**Note:** When adding a new sensor or replacing a sensor (old sensor replacement battery), you need to turn on the sensor power first, then follow the steps above to control the weather station.

**Note:** When the channel icon (the position of the display A15) displays the low voltage icon "", the battery of the corresponding channel wireless sensor is replaced according to the channel number of the channel icon. Then follow the steps above to re-add the wireless sensor to the weather station.

▶ In the normal time display interface, press and hold the "" button for 3 seconds, the wireless channel in the OUTDOOR REMOTO column will enter the loop mode, and the channel will be changed every 5 seconds (OUTDOOR|CH1|CH2|CH3), and the automatic conversion display will be different. Channel temperature | humidity value

**Note:** In the cycle mode, only the values of temperature and humidity are being converted, and the values of wind speed, wind direction, rainfall, etc. are not converted, and the values are still derived from the Multi-combination wireless sensor.

## Weather alerts viewing and setting

▶ Press and release the "" button to view the weather alerts mode. Continue to press and release the "" button to confirm and move to the next item.





**Note:** After 20 seconds without pressing any button or touch the " / ZZ" location button at any time to exit the view mode.

**Note:** View Outdoor | REMOTE Temperature | Humidity alert, press and release the "" button to switch to other channels.(A total of 4 channels: outdoor | CH1 | CH2 | CH3)

▶ In each weather alert view item, press and hold the "" button to turn the alert on or off.

**Note:** The weather alert is initially turned off by default, and the display is OFF. When the weather alert is turned on, it is displayed as ON.

▶ Press and hold the "" button for 3 seconds to enter the weather alert setting mode.

▶ Press and release the "" or "" button to adjust the value. Hold the "" or "" button to adjust quickly.

▶ Press and release the "" button to confirm and move to the next item.



**Note:** After 20 seconds without pressing any button or touch the “☀️ / ZZ” location button at any timeto exit the settings.

**Note:** Set Outdoor | REMOTE Temperature | Humidity alert, press and release the “CH” button to switch to other channels. (A total of 4 channels: outdoor | CH1 | CH2 | CH3)

### **View and Settings order:**

1. Outdoor | remote high temperature
2. Outdoor | remote low temperature
3. Outdoor | remote high humidity
4. Outdoor | remote low humidity
5. Indoor | remote high temperature
6. Indoor | remote low temperature
7. Indoor | remote high humidity
8. Indoor | remote low humidity
9. High wind speed
10. High 24-hours rainfall
11. High rainfall rate

## **Weather alert trigger**

- ▶ When armed alert value is reached, station will beep 5 times each minute, until out of alert range.
- ▶ The flashing alert icon will indicate if is a LOW or High alert.
- ▶ Press any button to stop the alert sound.
- ▶ The alert icon will flash while value is in alert range.

**Note:** If you want to permanently cancel the alert, enter the weather view mode, switch to the item you want to cancel, press and release the “⚙️” button to set to OFF

## **Weather forecast:**

- ▶ The weather station calculates a weather forecast for about the next 12 hours based on the barometric pressure trend. Of course this forecast can't compare to that of professional weather services supported by satellites and high performance computers, It provides only an approximate indication of the current weather development in a small local area. **Please take the weather forecast from your local weather forecasting service into account as well as the forecast from your weather station.**

Outdoor sensor collect real-time data and weather station track specific weather-related variables, including changes in temperature, humidity, and barometric pressure to produce a forecast with a personalized accuracy for your location ( which may not be same as Sky or BBC news forecast as there forecast is for very large area . ).

Weather icons flashing / blinking is fine too some time , which mean weather station thinks, that weather will be between two icon or will or may change rapidly .

Accuracy of the Weather forecast icon is about 70%-75%.

And your weather station information is for your location only .

Weather icon will change or may change after 12h or 4 days or more

► The weather station displays the following weather icon:

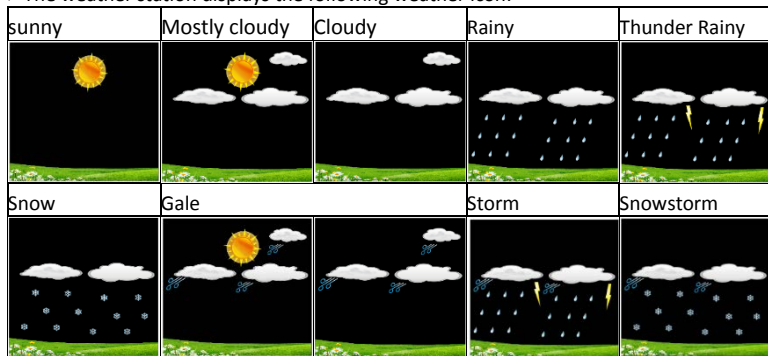

**Note:** The Snowy icon will only appear if the outdoor temperature (refers to the temperature detected by multiple combined sensors) is below -4°C (+25°F) and the forecast would be rainy or Thunder Rainy.

The Gale icon will only appear if the wind speed is above 50KM/H and the forecast would be Sunny or Mostly Cloudy or Cloudy.

The storm icon will only appear if the wind speed is above 50KM/H and the forecast would be rainy or thunder rain.

The Snowstorm icon will only appear if the outdoor temperature (refers to the temperature detected by multiple combined sensors) is below -4°C (+25°F) and the wind speed is above 50 KM / H and the forecast would be rainy or Thunder Rainy.

▶ After the weather station needs 7-10 days of air pressure calibration, the weather forecast will tend to be stable with an accuracy rate of 70%-75%.

▶ The weather station can display the barometric pressure trend.

▶ You may see the following displays:



: The barometric pressure will rise.



: The barometric pressure will remain constant.



: The barometric pressure will fall.

## Background lighting

▶ If the product is powered by batteries, Touch the “☀️ / ZZ” location button.

Backlight lit 15 seconds.

▶ When the power supply of the product is inserted into the power supply adapter, the battery will automatically disconnect the power supply, and the backlight will always be

bright. Press the ☀️ button to adjust the brightness of the backlight, you can adjust the 4 state: 3 different brightness backlight and close the backlight. When the backlight brightness is not at the maximum brightness, press the “☀️ / ZZ” button. Backlight turns to maximum brightness of 10 seconds.

**Note:** During the reception of the time radio wave signal, the backlight will be automatically closed to prevent the interference of the radio wave.

## Low battery:

▶ If the “Indoor sensor” column is display the battery icon “🔋”, you need to replace the weather station's battery as soon as possible,

## Mounting Instructions ( wireless sensor )

### Multi-combination Wireless Remote Sensor

▶ Mount in an open area clear for 15 meters (50 feet) in all directions.

▶ The sensor needs to be mounted on a sturdy platform or bracket that is mounted 1.5 m (5 ft) above the ground.

▶The base of the sensor is screwed to the platform and the support frame.Tighten the large nut that secures the support rod to the base

▶When installing, adjust the sensor body so that the solar panel faces south, otherwise the wind direction will be wrong. Note the “N” North Embossed Mark on the top of the sensor (requires a compass for proofreading, and the “N” North Emboss mark is identical to the “N” of the compass).

▶When installing the sensor, use the top bubble level to ensure the sensor level, otherwise the accuracy of the rainfall reading will be affected.

▶After completing the above two steps, lock the two hexagon socket screws on the side of the sensor body.

▶When installing, the fixing screws of the wind cup and the wind direction cursor should be tightened and tightened.

▶The rainforest structure of the sensor needs to be cleaned regularly (recommended cycle 1-3 months, depending on the frequency of rain):

1. Remove the rainwater funnel (turn the rain sand funnel according to the direction of rotation shown).

2. Gently remove debris or insects from the rain sensor.

3. Remove debris from the rainwater funnel itself, especially debris from the funnel drain.

4. Remove the debris from the drain.

5. Reinstall the rainwater bucket.

6. Note: Do not apply oil to the rain sensor.

Installation method 1

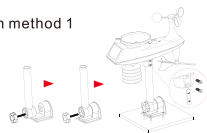

Installation method 2

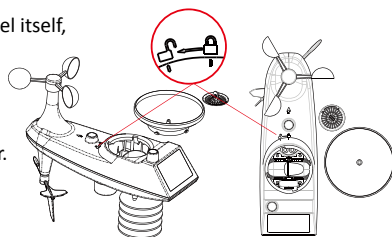
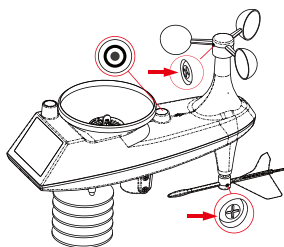
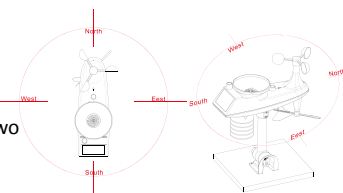
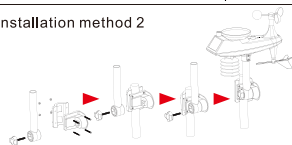

**Note:** Make sure the wireless sensor is installed within 100 meters of the weather station (empty, unobstructed). According to the thickness of the obstacle between the wireless sensor and the weather station, the distance should be shortened as much as possible (the distance after the wireless signal penetrates the obstacle will be shortened), otherwise the data transmission may be disturbed.

## Mounting Instructions (wireless sensor) Optional sensor Model no YC9318

### Temperature | Humidity Wireless Remote Sensor

Option 1:

- ▶ Mount the mounting screws to the wall.
- ▶ Hang the wireless sensor on the screw.

Option 2:

- ▶ Insert the mounting screws through the front of the wireless sensor into the wall.
- ▶ Tighten the screws to fit snugly (do not overtighten).
- ▶ If the wireless sensor is placed outdoors, install the temperature | humidity wireless sensor on a north facing wall or any shadow. The sun will make it even higher.
- ▶ The guardrail under the eaves or under the deck is preferred.
- ▶ Make sure the wireless sensor is installed vertically to vent moisture.

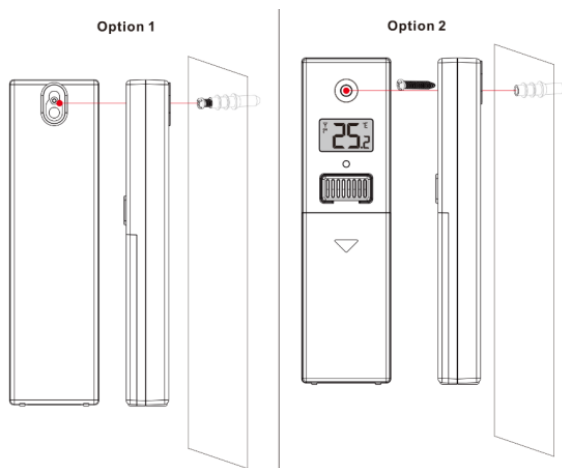

## Pro Installation Checkout

Note: We suggest you assemble all components of the weather station, including console in one location so you can easily test functionality. After testing, place the outdoor sensor package in the desired location. Note, however, that movement during assembly and movement after assembly can cause the rain sensor to “falsely” register rain. If outdoor temperature may go below 32F or 0C for prolonged periods, Lithium based batteries are suggested over alkaline type batteries for the

- Do not use rechargeable batteries
- Do not mix old and new batteries
- Ensure batteries are installed with correct polarity (+/-)
- Follow suggested order for battery installation (outdoor sensor first, console second) if you do not reset first.

Consider the following:

1. You must clean the rain gauge every few months and change the batteries every 1-2 years. Provide easy access to the weather station.
2. Avoid radiant heat transfer from buildings and structures. In general, install the sensor array at least 5 feet or 1.52m from any building, 9 structures, ground, or roof top. And sensor must be clear from all directions for clear air flow.

### **3. Avoid wind / rain obstructions.**

The rule of thumb is to install the sensor array at least four times the distance of the height of the tallest obstruction. For example, if the building is 20 feet or 6.10m tall and the mounting pole is 6' or 1.83m tall, install the sensor array  $4 \times (20 - 6)' = 56'$  or  $4 \times (6.1 - 1.83) = 17.08\text{m}$  away. 4. Mount the sensor array in direct sunlight for accurate temperature readings. 5. Installing the weather station over sprinkler systems or other unnatural vegetation may affect temperature and humidity readings. We suggest mounting the sensor array over natural vegetation.

### **6. Wireless Range.**

Radio communication between receiver and transmitter in an open field can reach a distance of up to 330 feet or 100 meter, providing there are no interfering obstacles such as buildings, trees, vehicles and high voltage lines. Wireless signals will not penetrate metal buildings. Under most conditions, the maximum wireless range is 100' or 30m.

7. Radio Interference. Computers, radios, televisions and other sources can interfere with radio communications between the sensor array and console. Please take this into consideration when choosing console or mounting locations. Make sure your display

console is at least five feet or 1.52 meter away from any electronic device to avoid  
Please note: You may require a long pole to install the outdoor sensor, Which is  
not included

Supplied in Box:

1 x Youshiko YC9467 Console

1 x Out door 7-in1 Sensor ( Model no : YC1120 )

1 x Instruction manual

1 x Mounting Hardware pack

1 x Power supply

All enquiries: [service@youshiko.co.uk](mailto:service@youshiko.co.uk)



Made for Youshiko in PRC