

RC WIRELESS THERMO-HYGRO WEATHER STATION WITH WEATHER FORECAST AND BAR CHART MODEL: YC9352 USER MANUAL

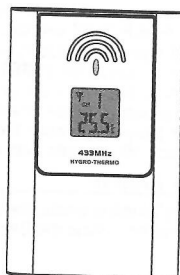
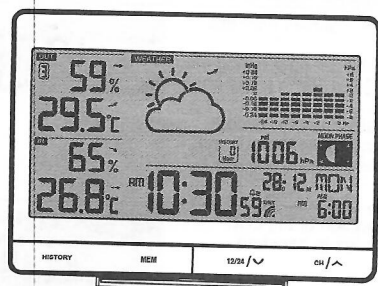

Thank you for selecting this delicate wireless weather station. Utmost care has gone into the design and manufacture of the clock. This manual is used for MSF version. Please read the instructions carefully according to the version you purchased and keep the manual well for future reference.

OVERVIEW

MAIN UNIT

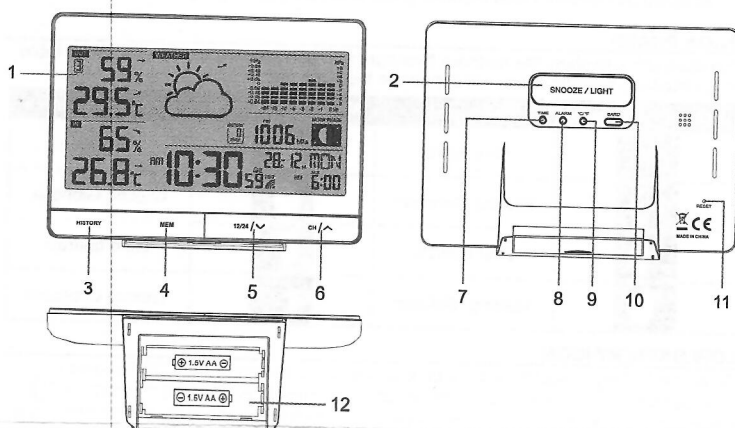

- LCD display
- [SNOOZE / LIGHT] key
 - When alarm is sounding, press to stop the current alarm and enter snooze.
 - When alarm is sounding, press and hold for 2 seconds to stop the current alarm, the clock will sound again in the next day.
- [HISTORY] key
 - In normal mode, press to display the past 24 hour pressure records.
- [MEM] key
 - In normal mode, press to check maximum and minimum thermo-hygro reading, or press and hold for 3 seconds to delete both records.
- [12/24 / V] key
 - In normal mode, press to switch between 12 or 24 hour format of time display, or press and hold for 3 seconds to activate wireless sensor pairing mode.
 - In setting mode, press to decrease the setting values.
- [CH / A] key
 - In normal mode, press to switch between CH 1~3 of outdoor sensor's weather display, or press and hold for 2 seconds to enter auto-cycle mode.
 - In setting mode, press to increase the setting values.
- [TIME] key
 - In normal mode, press to switch between alarm 1 and alarm 2, or press and hold for 2 seconds to enter time setting mode.
 - In time setting mode, press to step the setting.
- [ALARM] key
 - In normal mode, press to turn on/off alarm1 and alarm 2, or press and hold for 2 seconds to enter alarm setting mode.
 - In alarm setting mode, press to step the setting.
- [°C / °F] key
 - In normal mode, press to switch between Celsius and Fahrenheit, or press and hold for 3 seconds to receive the RC signal once.
- [BARO] key
 - In normal mode, press to switch between hPa (mb) and inHg, or press and hold for 3 seconds to enter the "rel" and "abs" switch mode.
- [RESET] key
 - In case of malfunction, press to reset the main unit.
- Battery compartment

LCD DISPLAY

- Ch. 1-3 temperature & humidity reading
- Indoor temperature & humidity reading
- Weather forecast, Baro pressure & moon phase section
- Time and calendar section

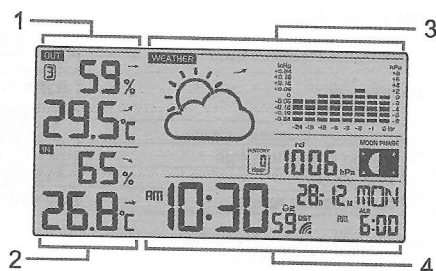

WIRELESS THERMO-HYGRO SENSOR

- LED indicator
 - Flashes when the remote unit is transmitting.
- LCD display
 - to show the detected temperature or humidity of the sensor.
- Wall mounting holder
- [RESET] key
 - Press to restart the sensor.
- [CHANNEL] slide switch
 - Assign the transmitter to Channel from 1 to 3.
- Battery compartment
 - Accommodates 2 x AA size batteries.

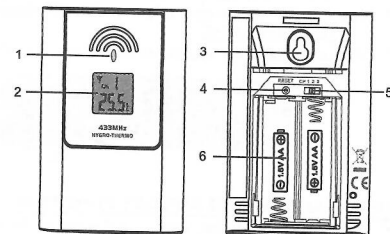

GETTING STARTED

BEFORE USING THE MAIN UNIT AND TRANSMITTER:

- Remove the battery door of the main unit and transmitter.
- Install 2 new AA size batteries for both main unit and transmitter, according to the polarity mark on the battery compartment.
- After the batteries are installed, all LCD segment will be shown.
- Press the [RESET] key of main unit first, and press the [RESET] key of transmitter.
- It will automatically receive 433 MHz signal from transmitter for channel test in 8 seconds.
- Replace the battery door.
- After 5 minutes channel test, it will turn to RC signal reception automatically.
- Radio controlled function, the current time automatically synchronized with the time signal transmitted from Anthorn, England (MSF60).

NOTE:

- The unit can operate up to 3 remote transmitters.
- Position the unit and transmitter within the effective transmission range: 30 meters in usual circumstances.
- In some cases, you may not receive the signal immediately, you can reset the unit and transmitter again as described above.
- Also in some cases, after pressing the reset buttons, clock time will self set automatically with in few mins to few hours or max by between 1am to 5am, depending on your location or radio signal, after that you never have to do anything.
- Please install wireless sensor outside, where direct sunshine and very heavy rain can be avoided for accurate readings.
- Once the channel is assigned to a sensor, you can only change it by removing the batteries or resetting the sensor, you also need to press and hold [12/24 / V] key for 3 seconds on main unit to pair this sensor. After replacing the batteries of the wireless sensor or the unit fails to receive wireless sensor signal of a specified channel, you need to press and hold [12/24 / V] key for 3 seconds on main unit to pair this sensor again.
- Place the units away from metal objects and electrical appliances like TV / Computer / Mobile phones / WiFi Hub etc to minimize the interference.

VIEW MULTIPLE WIRELESS SENSOR CHANNELS

- In normal mode, press [CH / A] key to switch the display between CH 1~3.
- In normal mode, press and hold [CH / A] key for 2 seconds to enter auto-cycle mode. After a "bi" sounds, it will alternately displays the CH 1~3 at 4 second intervals.
- During auto-cycle mode, press [CH / A] key again to stop auto-cycle mode and display the current channel.

RECEPTION OF RADIO CONTROLLED SIGNAL

The time and date are radio-controlled. The current time and date are automatically synchronized with the time signal transmitted from UK (MSF). When used for the first time (after inserting the batteries or pressing the [RESET] key), the clock will start to receive the RC signal after 5 minutes with the signal strength indicator flashing. You can also press and hold [°C / °F] key with 3 seconds to receive the RC signal once.

RCC SIGNAL INDICATOR

The signal indicator shows signal receive status. The signal receiving status could be classified into 2 types:



NOTE:

- Every day the wireless sensor will automatically search for the time signal at 2:00, 3:00, 4:00 and 17:00.
- Always place the unit away from interfering sources such as TV set, computer, etc.
- Avoid placing the unit on or next to metal plate.
- Closed area such as airport basement, tower block or factory is not recommended.
- Do not start reception on a moving article such as vehicle or train.
- User can permanent disable or enable the RC function by press and hold the [SNOOZE/LIGHT] key for 8 seconds.

DAYLIGHT SAVING TIME (DST)

This clock has been programmed to automatically switch when the daylight saving time is in effect. User can disable the DST function in time and calendar setting mode.

NOTE:

DST AUTO/OFF setting only available when RCC function is ON.

TIME AND CALENDAR SETTING

- In normal mode, press and hold [TIME] key for 2 seconds to enter date and time setting mode.
 - Press [CH / A] or [12/24 / V] key to adjust the setting.
 - Press [TIME] key to enter the next setting.
 - The setting sequence: year → DM / MD → month → day → DST AUTO / OFF → hour → minute → second → weekday language → ± 23 Hour offset.
 - Press [TIME] key or leave the unit for 30 seconds to complete the setting and return to normal mode.
- Weekday language GB → FR → DE → ES → IT

ALARM TIME SETTING AND DISPLAY

- In normal time mode, press [TIME] key to select the alarm 1 or alarm 2.
- In alarm1/alarm2 mode, press and hold [ALARM] key for 2 seconds until alarm hour digit flashes.

- Press [CH / \wedge] or [12/24 / V] key to change the value
- Repeat the above operations to set the alarm time in this order: Hour \rightarrow Minute \rightarrow Ice pre-alarm on/off.
- Press [ALARM] key or leave the unit for 30 seconds to return to normal mode.



USING ALARM AND SNOOZE FUNCTION

- Set the desired alarm time as described in the previous section.
- Or press [ALARM] key to turn on alarm 1, press it again to turn on alarm 2, press it thrice to turn on both alarm 1 and alarm 2, with the alarm icons "A1" and / or "A2" displays on the LCD. Press it again to turn off both alarm 1 and alarm 2, with the icons disappear.
- When clock reach the alarm time, alarm sound will start.

Where it can be stopped by following operation:

- Auto-stop after 2 minutes alarming if without any operation and the alarm will activate again in the next day.
- By pressing [SNOOZE / LIGHT] key to enter snooze that the alarm will sound again after 5 minutes.
- By pressing and hold [SNOOZE / LIGHT] key for 2 seconds to stop the alarm and will activate again in the next day
- By pressing [ALARM] key to stop the alarm and the alarm will activate again in the next day.

NOTE:

- The alarm function will turn on automatically once you set the alarm time.
- The snooze could be used continuously in 24 hours.
- During the snooze, the alarm icons "A1" and / or "A2" will keep flashing.
- The ice pre-alarm will be activated when the alarm 1 and / or 2 is on.
- Once the ice pre-alarm activates, the preset alarm will sound 30 minutes earlier if the outdoor temperature is below -3°C.
- To activate the ice pre-alarm function, pls ensure:
 - Turn on the ice pre-alarm function in the alarm setting mode.
 - Turn on the corresponding alarm.

READING INDOOR/OUTDOOR TEMPERATURE & HUMIDITY FUNCTION

In normal mode, press [°C / °F] key to switch between °C / °F temperature unit. The temperature and humidity will display "Hi / Lo / --" on the conditions in the following chart:

Area	Condition	Display
Temperature	Temperature < -40°C	LO
	Temperature > 70°C	HI
Humidity	Humidity < 20%	LO
	Humidity > 90%	HI
	Temperature < -40°C or > 70°C	--

NOTE:

- If no signals are received or the transmission is interfered, "--" will appear on the LCD.
- Relocated the clock or transmitter in other positions and make sure the transmission is within the effective range of 30m approx.

BARO, TEMPERATURE AND HUMIDITY TREND

The Barometric pressure, temperature and humidity trend indicator shows the trends of changes in the forthcoming few minutes. Arrows indicate a rising, steady or falling trend.

Arrow indicator	Trend
	Rising
	Steady
	Falling

BAROMETRIC/ATMOSPHERIC PRESSURE

TO SELECT THE PRESSURE DISPLAY MODE

- Press and hold the [BARO] key for 2 seconds to enter select model
- Press [CH / \wedge] or [12/24 / V] key to select between:
 - abs --- the absolute atmospheric pressure of your location.
 - rel --- the relative atmospheric pressure based on the sea.
- In "abs" mode, press [BARO] key to exit. In "rel" mode, press [BARO] key to set relative atmospheric pressure value in next section.

TO SET RELATIVE ATMOSPHERIC PRESSURE VALUE

- Get the atmosphere pressure data of the sea level (it is also the relative atmosphere pressure data of your home area) through the local weather service, internet and other weather channels.
- Press and hold [BARO] key for 2 seconds until "abs" or "rel" icon flashes.
- Press [CH / \wedge] or [12/24 / V] key to switch to "rel" mode.
- Press [BARO] key once again until the "rel" atmosphere pressure digit flashes.
- Press [CH / \wedge] or [12/24 / V] key to change its value.
- Press [BARO] key to save and exit the setting mode, or let it exit automatically 30 seconds later without pressing any key.

TO SELECT THE MEASUREMENT UNIT FOR THE BAROMETER

Use the [BARO] key to change the unit between hPa (mb) / inHg.

NOTE:

- When power up the main unit, it will display the relative pressure reading and default value is 1013 mb/hPa (29.91 inHg), which refers to the average atmosphere pressure.
- When you change the relative atmosphere pressure value, the weather indicators will change along with it.
- The relative atmosphere pressure is based on the sea level, but it will change with the absolute atmosphere pressure changes after operating the clock for 1 hour.

WEATHER FORECAST

The built-in barometer can notice atmosphere pressure changes. Based on the data collected, it can predict the weather conditions in the forthcoming 24 ~ 72 hours.

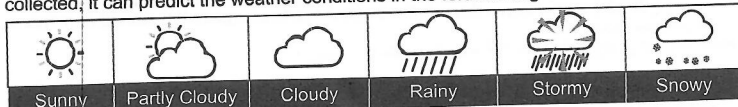

NOTE:

- The accuracy of a general pressure-based weather forecast is about 70% to 75%.

- The weather forecast is meant for the next 24 ~ 72 hours, it may not necessarily reflect the current situation.
- The Snowy weather forecast is not based on the atmospheric pressure, but based on the temperature of current channel. When the outdoor temperature is below -3°C, on the temperature of current channel. When the outdoor temperature is below -3°C, the Snowy weather indicator will be displayed on the 24 HOUR FORECAST display section.

PAST 24 HOURS HISTORY PRESSURE RECORD

The current and historical atmosphere is shown near the 24 HOUR FORECAST section. To check the pressure history in a particular hour during the past 24 hours, press the [HISTORY] key. Each press on the key will go back by an hour. Under the pressure history mode, press any key (except [HISTORY] key) to go back the normal mode, or let it exit automatically 30 seconds later without pressing any key.



HISTORY GRAPH

The history graph is under the time section of the LCD displays that can show the Baro histories in bar chart format.

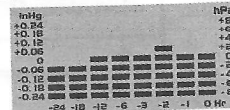

MAX / MIN RECORD

The main unit preserves the MAX / MIN weather data records since the last manual reset.

- In normal mode, press [MEM] key once to show the indoor & current outdoor channel maximum temperature and humidity records.
- Press [MEM] key repeatedly to show the minimum records.
- Press [MEM] key again to exit.
- To erase all the MAX / MIN records, press and hold [MEM] key for 3 seconds.

MOON PHASE

The main unit can show the northern hemisphere moon phase status, below is the table which illustrate how the moon will appear on the main unit.

Moon Phase Icon	Description	Moon Phase Icon	Description
	New Moon		Full Moon
	Waxing Crescent		Waxing Gibbous
	First quarter		Third quarter
	Waxing Gibbous		Waxing Crescent

LOW BATTERY ICON

When the battery indicator " " appear on the clock section or the LCD becomes dim, replace with 2 new AA size batteries at once; while if the low battery indicator " " appear in the outdoor section, it indicates that the battery power of the transmitter is not enough, and you should replace with 2 x AA size batteries at once.

IMPORTANT NOTE

- This main unit is intended to be used only indoors.
- Do not subject the unit to excessive force, shock, dust, temperature or humidity.
- Do not cover the ventilation holes with any items such as newspapers, curtains etc.
- Do not immerse the unit in water. If you spill liquid over it, dry it immediately with a soft, lint-free cloth.
- Do not clean the unit with abrasive or corrosive materials.
- Do not tamper with the unit's internal components. This invalidates the warranty.
- Only use fresh batteries. Do not mix new and old batteries.
- Do not dispose old batteries as unsorted municipal waste. Collection of such waste separately for special treatment is necessary.
- Attention! Please dispose of used unit or batteries in an ecologically safe manner.
- Technical specifications and user manual contents for this product are subject to change without notice.

SPECIFICATIONS

MAIN UNIT

Dimensions (W x H x D)	140 x 103.5 x 51mm
Main power	2 x AA size 1.5V batteries
Barometer display range	540 to 1100hPa (+/- 4hPa at 0 ~50°C, 700 ~ 1100hPa condition), 15.95 to 32.49inHg
Operating temperature range	-5°C to 50°C (23°F to 122°F)
Display temperature range (In / Outdoor)	-40°C to 70°C (-40°F to 158°F)
Display humidity range (In / Outdoor)	RH 20% to 90 %
Resolution of temperature	1 decimal place of °C/°F (above -10°C / °F) Integer of °C/°F (below -10°C / °F or above 100 °F)
Resolution of humidity	1%
Resolution of Barometer	Integer of hPa 1 decimal place of inHg
Number of sensors support	Up to 3 units
Radio controlled signal	MSF

WIRELESS SENSOR

Dimensions (W x H x D)	65 x 100 x 35mm
Main power	2 x AA size 1.5V batteries (Lithium battery recommended for low temperature environment)
Operating temperature range	-20°C to 60°C (-4°F to 140°F)
Operating humidity range	RH 1% to 99 % (non-condensing)
RF frequency	433MHz
RF transmission range	30 meters

All enquiries: service@youshiko.co.uk
Made for Youshiko in PRC





Youshiko Weather Station

QUICK START GUIDE

To **setup** the weather station, simply insert the batteries in weather station and sensor, take a pin press reset key on both units and then leave it. It will take few minutes to few hours or maximum by 5 am and it will set everything automatically.

After the first 24Hour setup.

Then you may choose the Barometer (air pressure) to your location suitably.

There are two options for Barometer

Relative pressure (rel) is the atmospheric pressure corrected to sea-level conditions.

To compare pressure conditions from one location to another, meteorologists correct the measured pressure (referred to as absolute pressure) to sea-level conditions. Because the air pressure decreases as you rise in altitude, the sea-level corrected pressure (the pressure your location would be at if located at sea-level) is higher than your measured pressure if you live above sea-level and lower than your measured pressure if you live below sea-level, relative pressure is larger than absolute pressure unless you live at or below sea-level.

Absolute pressure (abs) is the measured atmospheric pressure; Absolute pressure is not corrected to sea-level conditions.

To compare pressure conditions from one location to another, meteorologists correct pressure to sea-level conditions (referred to as relative pressure, or pressure relative to sea-level). Because the air pressure decreases as you rise in altitude, the sea-level corrected pressure (the pressure your location would be at if located at sea-level) is higher than your measured pressure if you live above sea-level and lower than your measured pressure if you live below sea-level.

To change relative (rel) pressure to absolute pressure (abs)

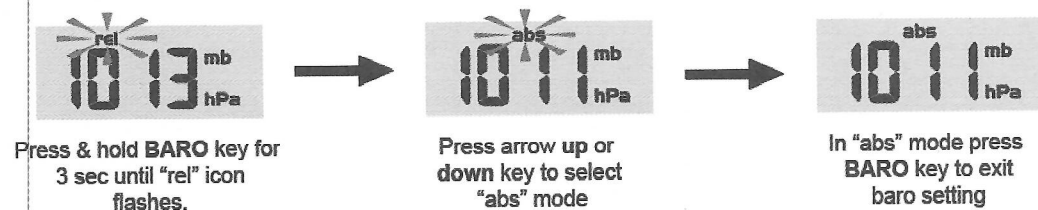

To change absolute (abs) pressure to relative pressure (rel)

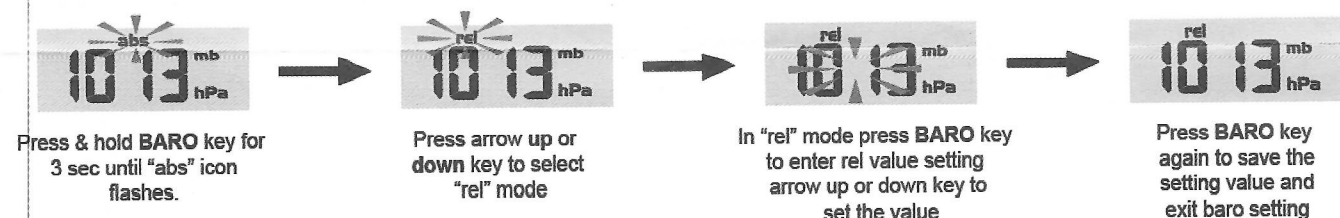

After this, your weather station will be all set, Please note: It may take further 48H for barometer reading to settle down, just keep the main unit away from other electronics devices like TV, Computer, Mobile phones, Wi-Fi hub etc to avoid interference. Thank you.

If you have any further enquires please e mail to: service@youshiko.co.uk