



# Revesperfil

Perfis e Revestimentos, Lda

We create solutions...



+351 914 990 558  
+351 244 491 668



export@revesperfil.pt  
geral@revesperfil.pt

**Revesperfil- Perfis e Revestimentos, Lda** presents a wide range of products that meet your needs and requirements.

As an ecologically responsible company, we are in constant evolution of mechanisms, processes and methodologies that allow us to advance both in quality as well as quantity, so that we are each increasingly closer to you.

We are a family company, with many years of experience and know-how that has developed top products to provide you with the best on the market.

Present us the problem, we have the solution!



**Here we show you the main brands we represent...**

We exclusively manufacture Perclic products, that goes from flooring accessories to false ceilings/panneling.



Hidrolic is our top brand for SPC composite flooring, that allows our customer to have the best SPC, with no worries.



FTD Floors is our recent brand for competitive SPC composite flooring, with the purpose to present our customer a high quality product with variety.



RevDek Deck Solutions presents products in different materials (IPE, Cumaru, Bamboo, WPC, etc) to install outside building high quality decks.



RevDek Wall Solutions is a brand for wall coatings (exterior and interior), in different components, decors and types of products.





The **Hydroclíc Floors** is a range of SPC composite flooring, bevelled and synchronized.

All ranges below come with IXPE underlay included and with the best click fitting system on the market, Uniclic.



- 5mm thick
- size 1220x181mm
- commercial class 0.55mm



- 6,5mm thick
- size 1535x228mm
- commercial class 0.70mm



- 5mm thick
- size 590x118mm
- commercial class 0.55mm



EASY INSTALLATION



ECO FRIENDLY



HEALTH & SAFETY



ANTIBACTERIAL



WARM UNDERFOOT



SOUND INSULATION



*A range of excellence, already on the market for over 7 years! It was one of the first SPC brands in Portugal and with reference works that prove its category.*

**High quality water resistant flooring!**

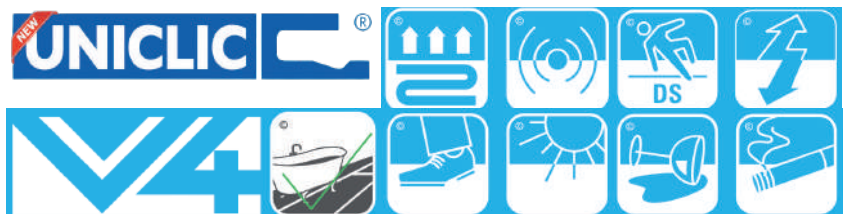



Some examples...



**FTD Floors**<sup>®</sup>  
Flooring Solutions



**FTD Floors** SPC Composite Flooring is a rigid vinyl floor, which has a wide range of colors and features to meet your needs and preferences.

FTD Floors come with IXPE underlay included and all with the best click fitting system on the market, Uniclic.

**FTD Floors**<sup>®</sup>  
Flooring Solutions  
Spanish Collection

- 5mm thick
- size 590x118mm
- commercial class 0.55mm

**FTD Floors**<sup>®</sup> **XL**  
Flooring Solutions  
Italian Collection

- 6,5mm thick
- size 1535x228mm
- commercial class 0.70mm



Water Resistant



Synchronized Pore



Click System



Best Cost-Placement Equation



Stain Resistant



Crack Resistant



Suitable for WC



*It is a **water resistant** flooring that can be applied throughout your home, without worries or complications.*

*We present FTD Floors as a flexible and versatile brand that aims to reach everyone.*





Some examples...



Revdek's EP Deck Board Composite Deck is manufactured in Portugal, according to high quality standards and with several years of testing and improvements.

Its ruler is a solid ruler, but light, becoming a board with quality and economical.



PVC Alveolar Beam  
38X28mm



PVC Link Clip

8 ml		<b>1m<sup>2</sup></b>
3,5 ml		
32 unid.		

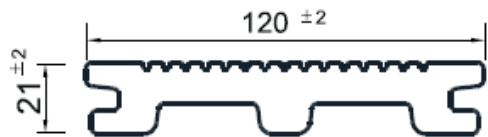

2300 x 120 x 21 mm

2,45 kg / ml





**EXTERIOR**

## PREMIUM WALL BOARD TEXTURED

- ✓ Innovative product
- 🔧 Realistic imitation of textured wood
- ☀️ High resistance to scratches and stains
- ☀️ High resistance to UV's – outdoor use
- 💧 Low water absorption - waterproof
- 📄 HDM Core
- 🔥 Fire Class Bfl – S1
- 👉 Low maintenance
- ♻️ FSC Certificate
- ⚙️ Easy installation

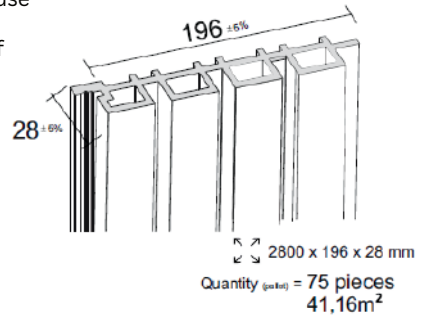

Ref.: DC.REVD.WALL.PREM196-....

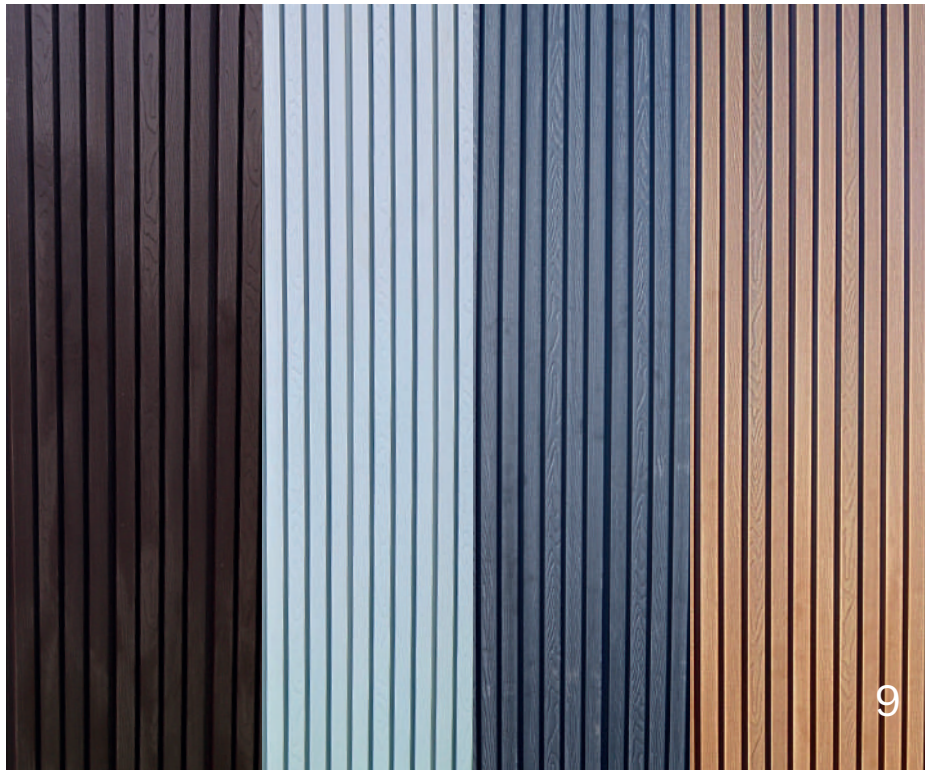



## WALL BOARD MDF CLADDING

**INTERIOR**

- ✓ Suitable for areas with low humidity
- ✓ PVC free
- ✓ Sustainable and Ecological
- ✓ Different models with different tones/colors
- ✓ Excellent finish
- ✓ Soft touch
- ✓ Provides a refined and luxurious environment

Ref.: RP.LB3783-...



4 boards per box = 1,243 m<sup>2</sup>  
2800x111x18mm

**LB-3771**

Ref.: RP.LB3771-...

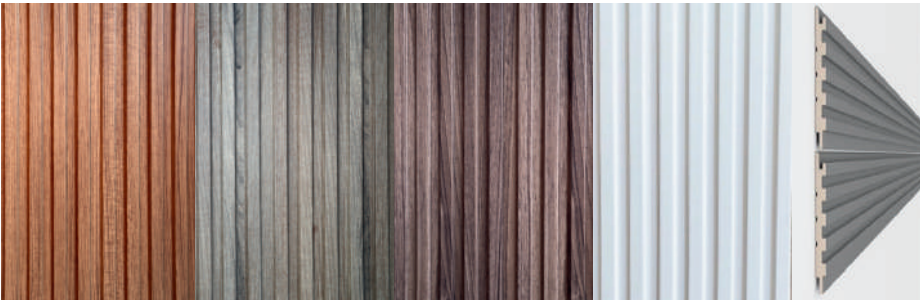

4 boards per box = 1,568 m<sup>2</sup>  
2800x140x12mm

**LB-3783**



**INTERIOR / EXTERIOR**

## WALL BOARD PVC CLADDING

- ✓ Innovative product
- ✓ Low maintenance
- ✓ Color diversity
- ✓ Suitable for areas with slight humidity
- ✓ Easy installation
- ✓ 100% recyclable
- ✓ Best quality-price ratio
- ✓ Imitation insulated wooden beams - authentic feel

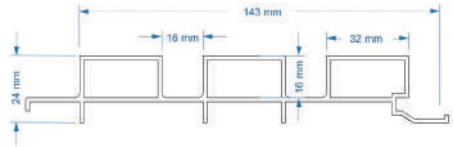

2800x143x22,5mm  
5 units per box = 2,002m<sup>2</sup>

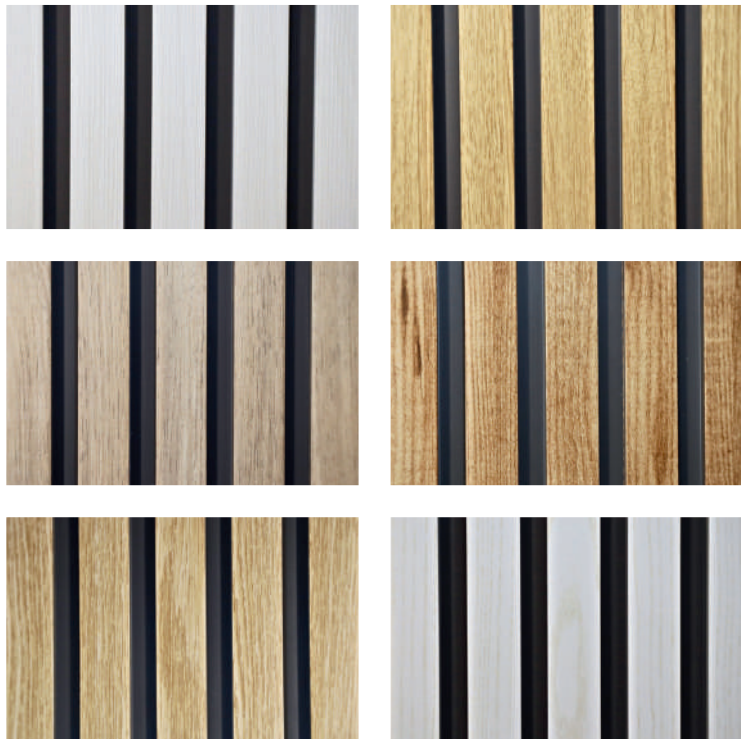

Ref.: RP11.280.143.22-...



## SPC WALL COVERING - MATTE PANELS

- ✓ Easy installation DIY
- ✓ Invisible fixation
- ✓ Best relation cost-quality
- ✓ Possibility of glue or screw
- ✓ Rigid SPC
- ✓ Matte effect

### RP.SPC.CLIP

Clip de fixação



Quantidade por caixa

24 uni

Quantidade por painel

6 uni

Recomendado fixar de  
50cm em 50cm

### RP.SPC.280.60.4.5-01

Stone Marble



### RP.SPC.280.60.4.5-02

Stone Grey



### RP.SPC.280.60.4.5-03

Stone Black



#### Panel Dimensions

2800x600x4,5 mm

#### Box Weight

66Kg

#### Quantity Per Box

4 panels = 6,72m<sup>2</sup>

#### Quantity per Pallet

20 boxes



**Perclíc**  
Perfis

**PROFILES  
SKIRTINGS  
TRIM BOARD  
PVC FALSE CEILING / PANNELING**

**ALUMINIUM PROFILES**

Available in self-adhesive\*



Transition Profiles



Finishing Profiles



Slope Profiles

**PVC PROFILES**

Available in self-adhesive\*



Transition Profiles



Finishing Profiles



Slope Profiles

**SKIRTINGS**



PVC SKIRTINGS



WOOD SKIRTINGS

**FALSE CEILING / WALL COVERING**

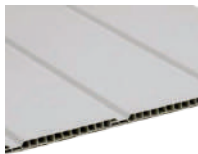

125mm Frieze



125mm Micro Bevel

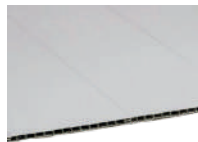

200mm Plain

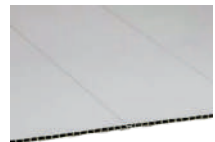

250mm Micro Bevel



**Perclíc**  
Perfis

# PROFILES SKIRTINGS TRIM BOARD PVC FALSE CEILING / PANNELING

ALUMINIUM FIT-IN

ALUMINIUM SELF-ADHESIVE

PVC FIT-IN

PVC SELF-ADHESIVE

TRANSITION PROFILE REF.: P.T40  
Aluminium Fit-in

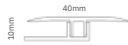

SLOPE PROFILE REF.: P.C40  
Aluminium Fit-in



BASE REF.: P.B07  
5,5mm - 8mm

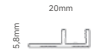

TRANSITION PROFILE REF.: PA.T30  
Aluminium Self-Adhesive



TRANSITION PROFILE REF.: P.T33  
Aluminium Fit-in



SLOPE PROFILE REF.: P.C34  
Aluminium Fit-in



BASE REF.: P.B10  
8mm - 10mm



SLOPE PROFILE REF.: PA.C40  
Aluminium Self-Adhesive

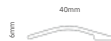

TRANSITION PROFILE REF.: P.T25  
Aluminium Fit-in



FINISHING PROFILE REF.: P.F30  
Aluminium Fit-in



BASE REF.: P.B15  
11,5mm - 15mm



FINISHING PROFILE REF.: PA.F23  
Aluminium Self-Adhesive



LADDER PROFILE REF.: P.FE40  
Aluminium Fit-in



FINISHING PROFILE REF.: P.F24  
Aluminium Fit-in



BASE REF.: P.B17  
15mm - 18,5mm



CORNER PROFILE REF.: P.C23.23  
Aluminium Self-Adhesive



TRANSITION PROFILE REF.: PP.T35  
PVC Fit-in



BASE REF.: PP.B10  
8mm - 12mm



TRANSITION PROFILE REF.: PPA.T35  
PVC Self-Adhesive



SLOPE PROFILE REF.: PP.C40  
PVC Fit-in



BASE REF.: PP.B12  
10mm - 14mm



SLOPE PROFILE REF.: PPA.C40  
PVC Self-Adhesive



FINISHING PROFILE REF.: PP.F30  
PVC Fit-in



BASE REF.: PP.B17  
15mm - 18,5mm



FINISHING PROFILE REF.: PPA.F20  
PVC Self-Adhesive



CORNER PROFILE REF.: PPA.C25.25  
PVC Self-Adhesive





**Perclic**  
Perfis

**PROFILES  
SKIRTINGS  
TRIM BOARD  
PVC FALSE CEILING / PANNELING**

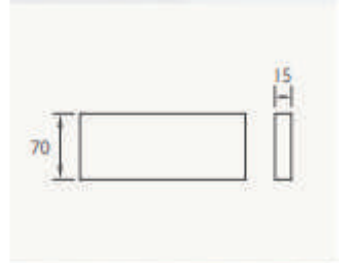
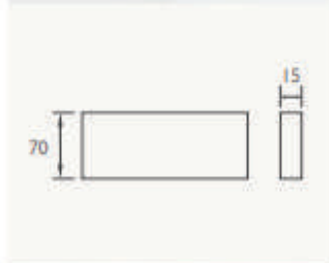
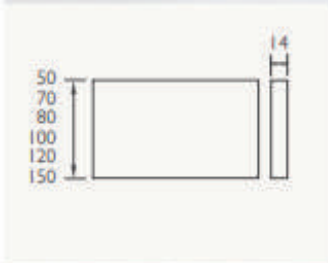

**EXPANDED PVC SKIRTING**

R08.70.14...  
R08.100.14...

**Dimensions**

70 x 14 x 2500 mm  
100 x 14 x 2500 mm

**PVC STRONG SKIRTING  
SELF-ADHESIVE**

R12A.70.15...

**Dimensions**

70 x 15 x 2500 mm

**PVC PREMIUM SKIRTING**

R13.70.15...

**Dimensions**

70 x 15 x 2500 mm

**NEW!**

**Dimensions**

- R08.50.14... - 50 x 14 x 2500 mm
- R08.80.14... - 80 x 14 x 2500 mm
- R08.120.14... - 120 x 14 x 2500 mm
- R08.150.14... - 150 x 14 x 2500 mm

Some examples...



Photo | Mauro Matos



**inovadora 23**



Rua 25 de Novembro, 9762 2480-168 Ribeira de Baixo - Leiria, Portugal

# Revesperfil

Perfis e Revestimentos, Lda

MADE IN PORTUGAL  
*naturally*

Promoted by



Cofinanced by

