

# GILBARCO ADVANTAGE B05 NON-OPTIMIZED

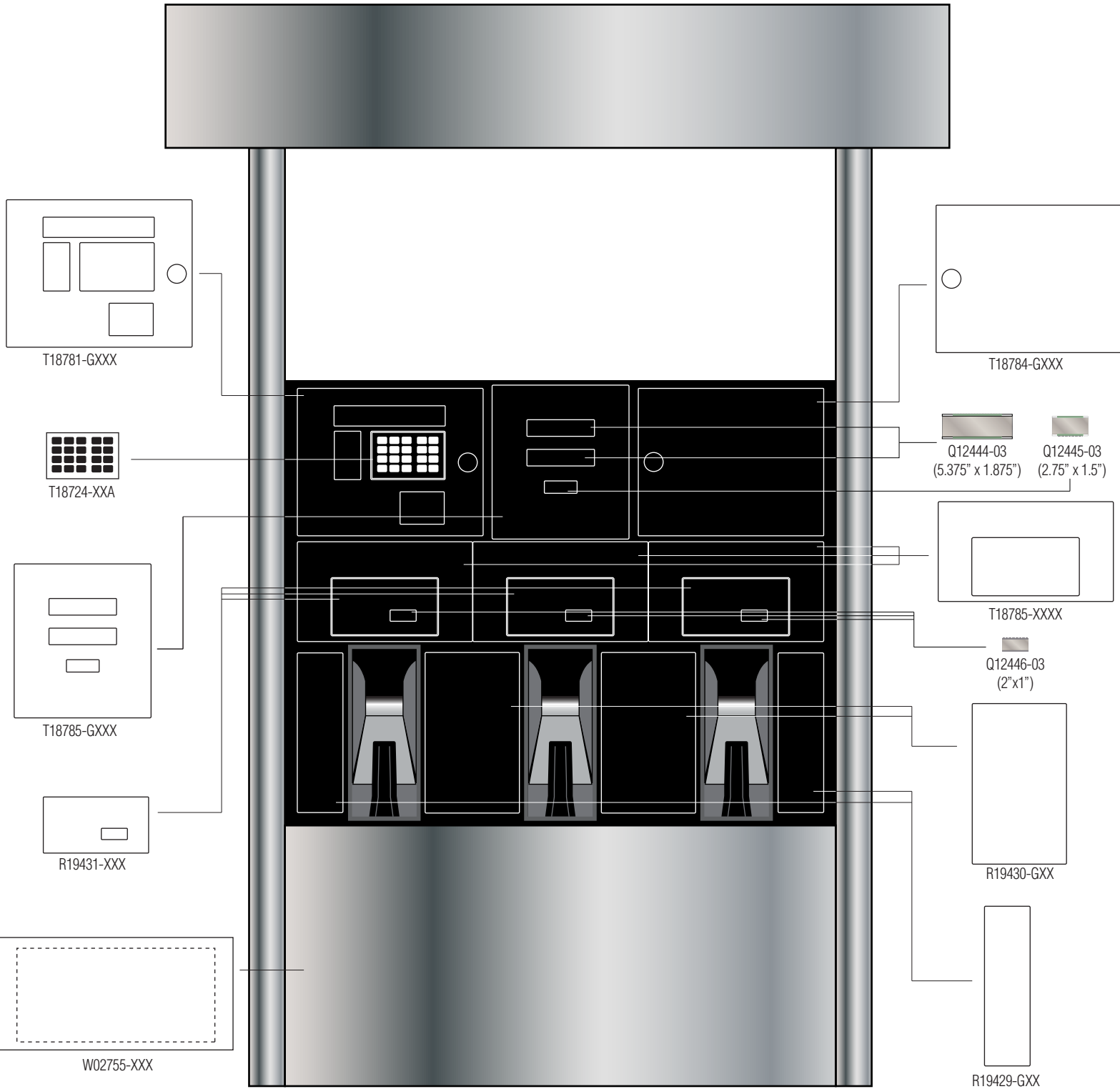

# GILBARCO ADVANTAGE B05 OPTIMIZED

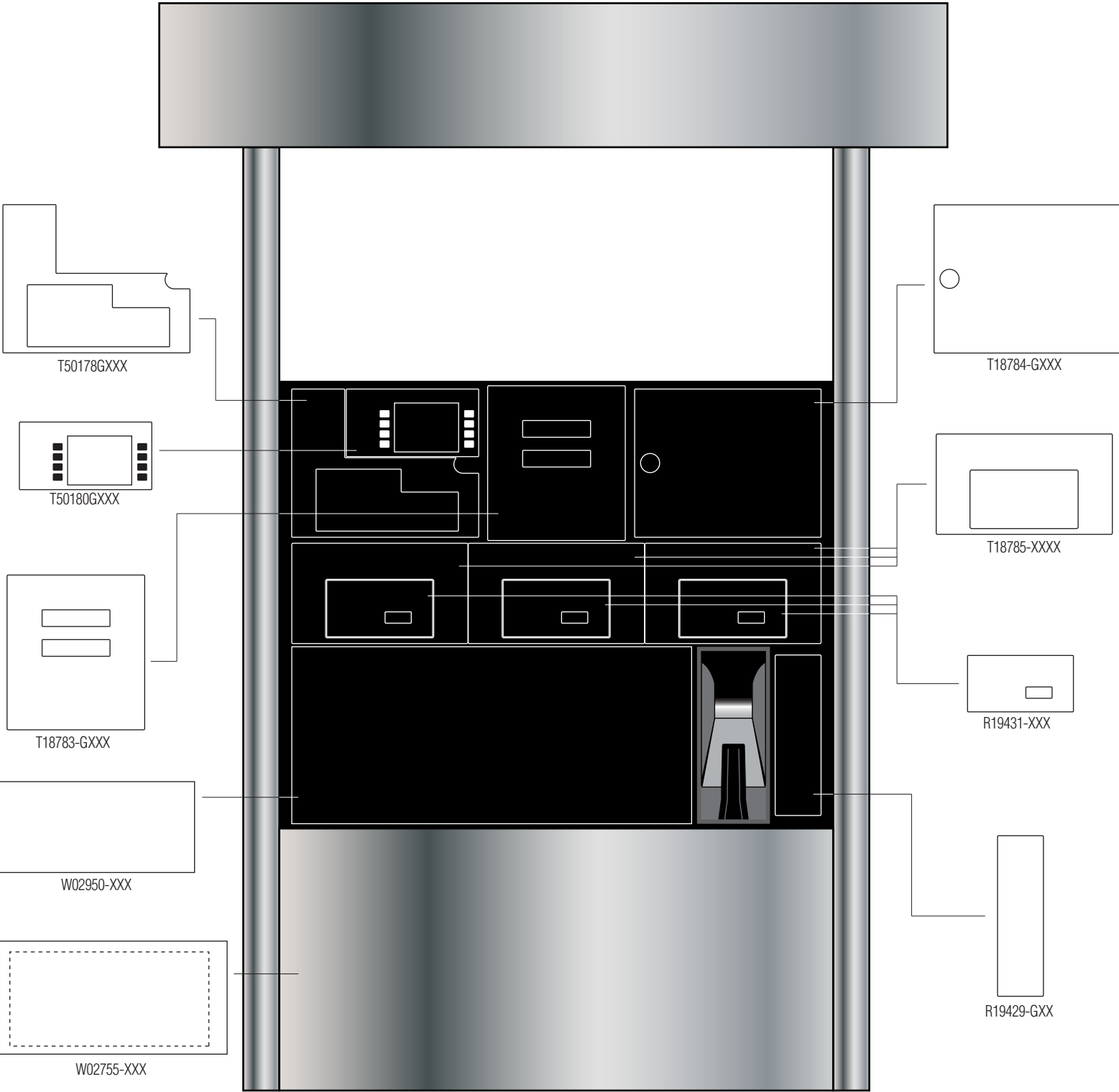

# GILBARCO ADVANTAGE B07

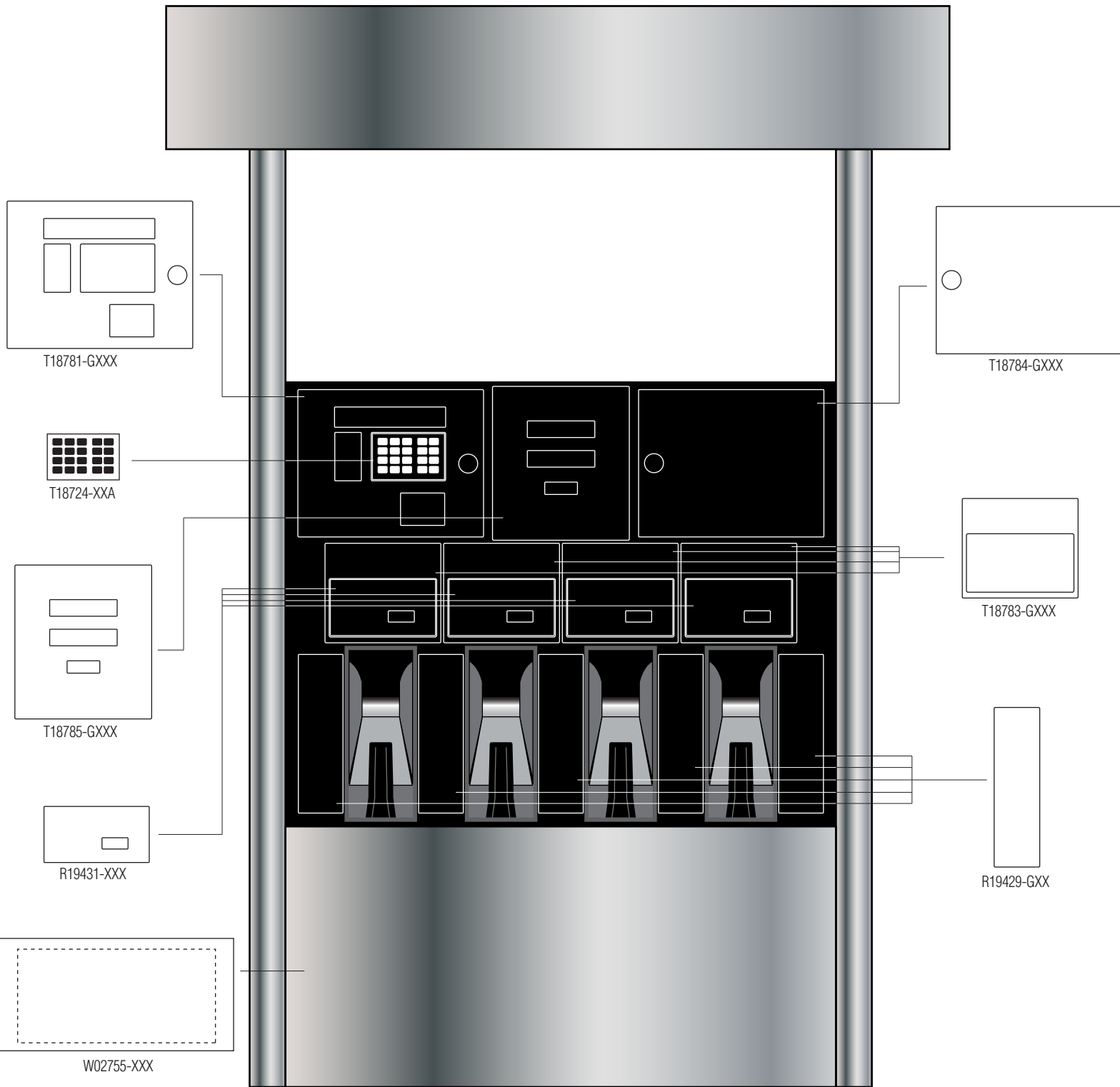

# GILBARCO ADVANTAGE B7C NON-OPTIMIZED

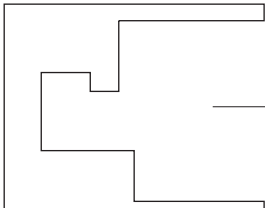
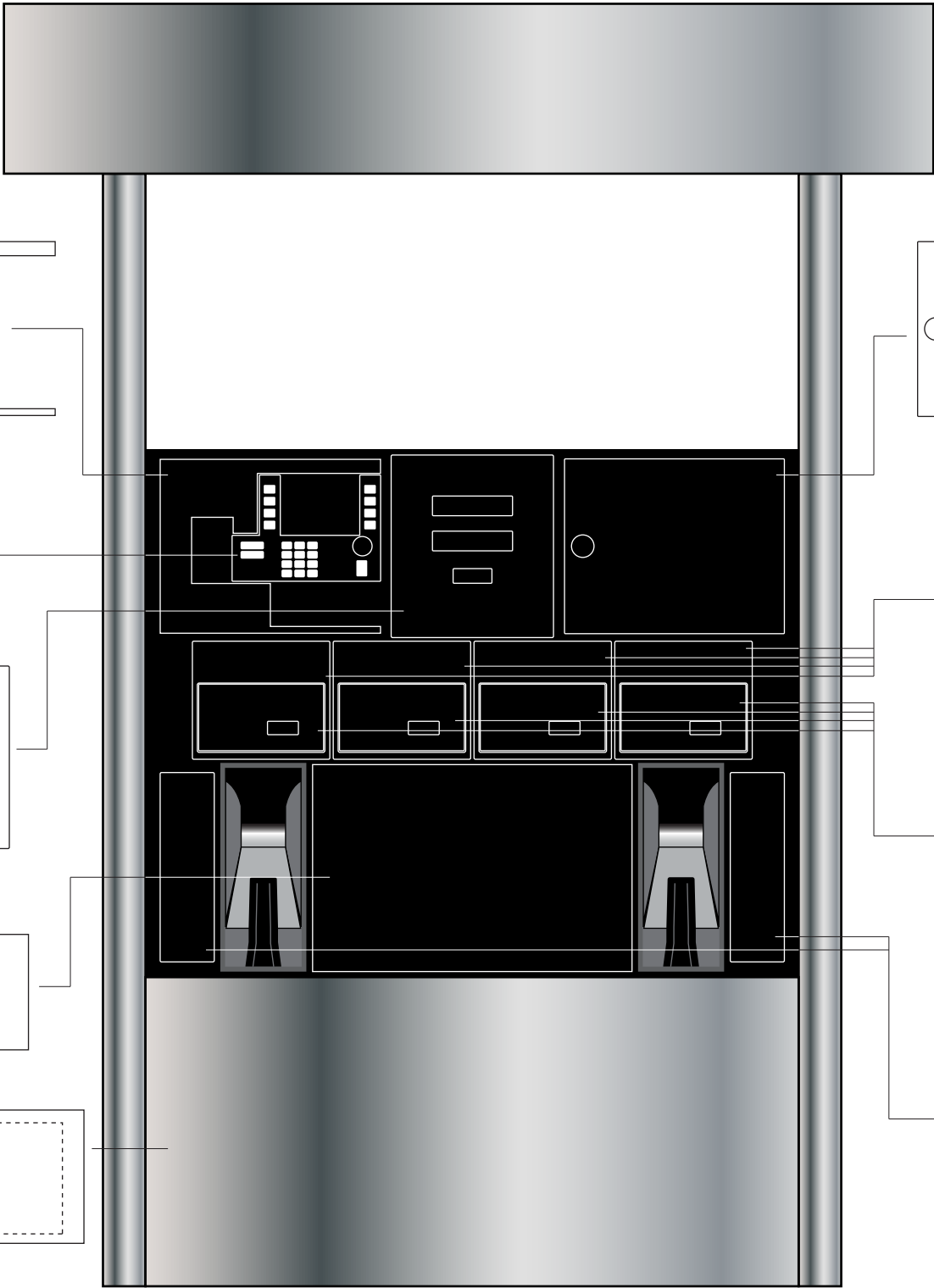

T50044-GXXX

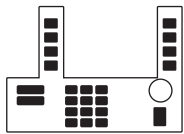

T50038-GXXX

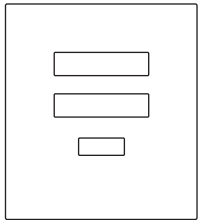

T18785-GXXX



T19302-XXX



W02755-XXX

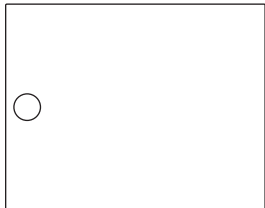

T18784-GXXX

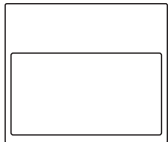

T18783-GXXX



R19431-XXX



R19429-GXX

# GILBARCO ADVANTAGE B7C OPTIMIZED

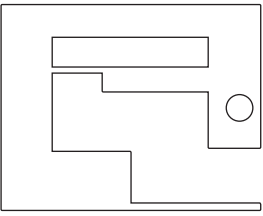

T50063-GXXX



T50064-XXX

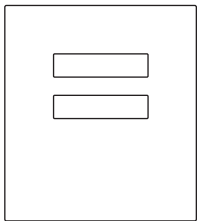

T18783-GXXX

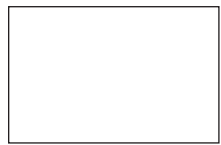

T19302-XXX



W02755-XXX

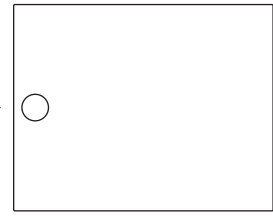
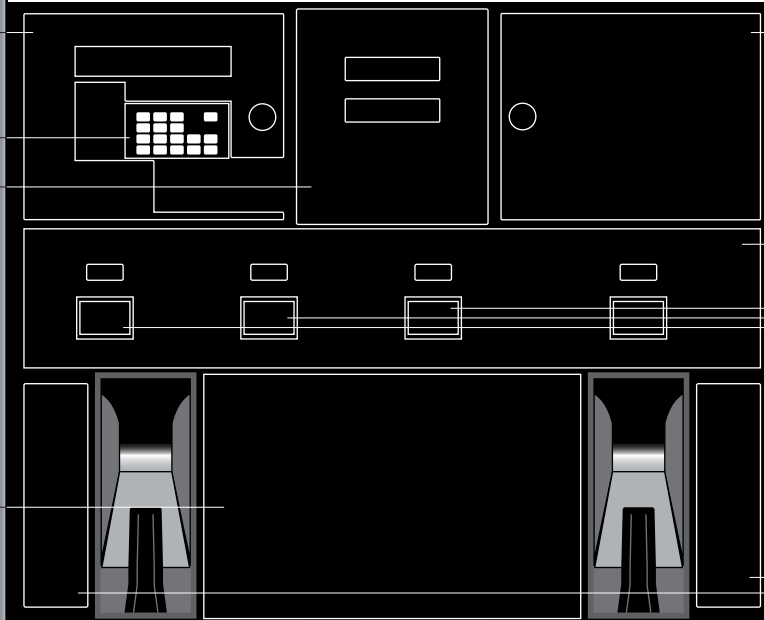

T18784-GXXX



W02872-XXX



R60030-XXX  
ORS-XXX



R19429-GXX

# GILBARCO ADVANTAGE B15

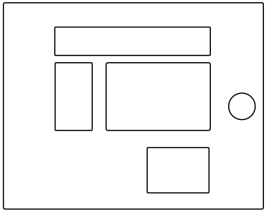
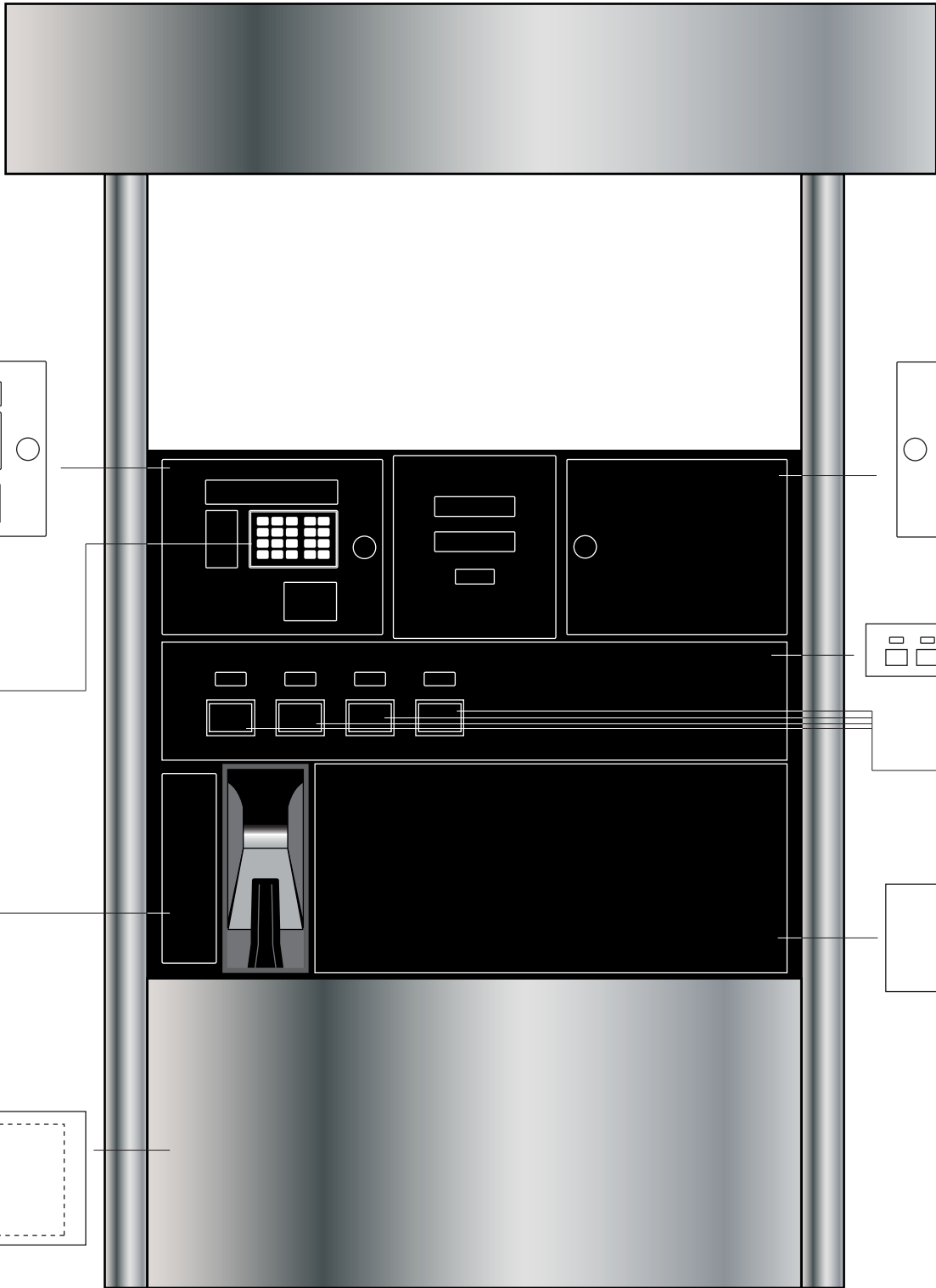

T18781-GXXX

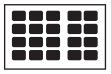

T18724-XXA



R19429-GXX



W02755-XXX

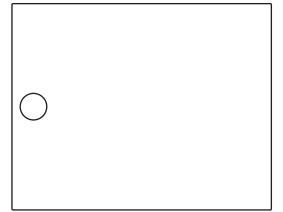

T18784-GXXX

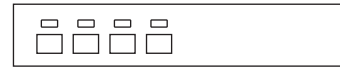

W02872-XXX



R60030-XXX  
ORS-XXX



W02950-XXX

# GILBARCO ADVANTAGE B21

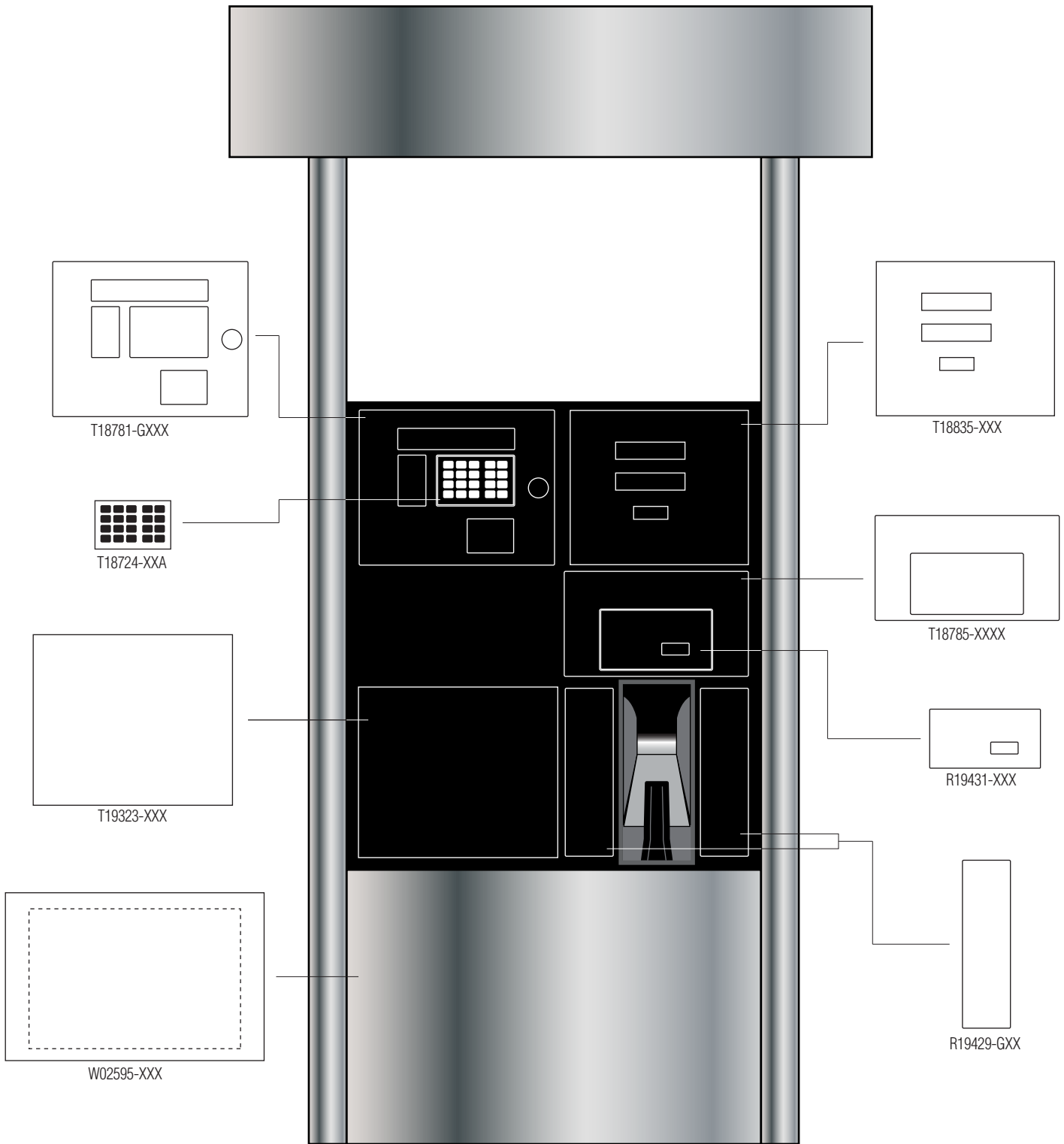

# GILBARCO ADVANTAGE B21

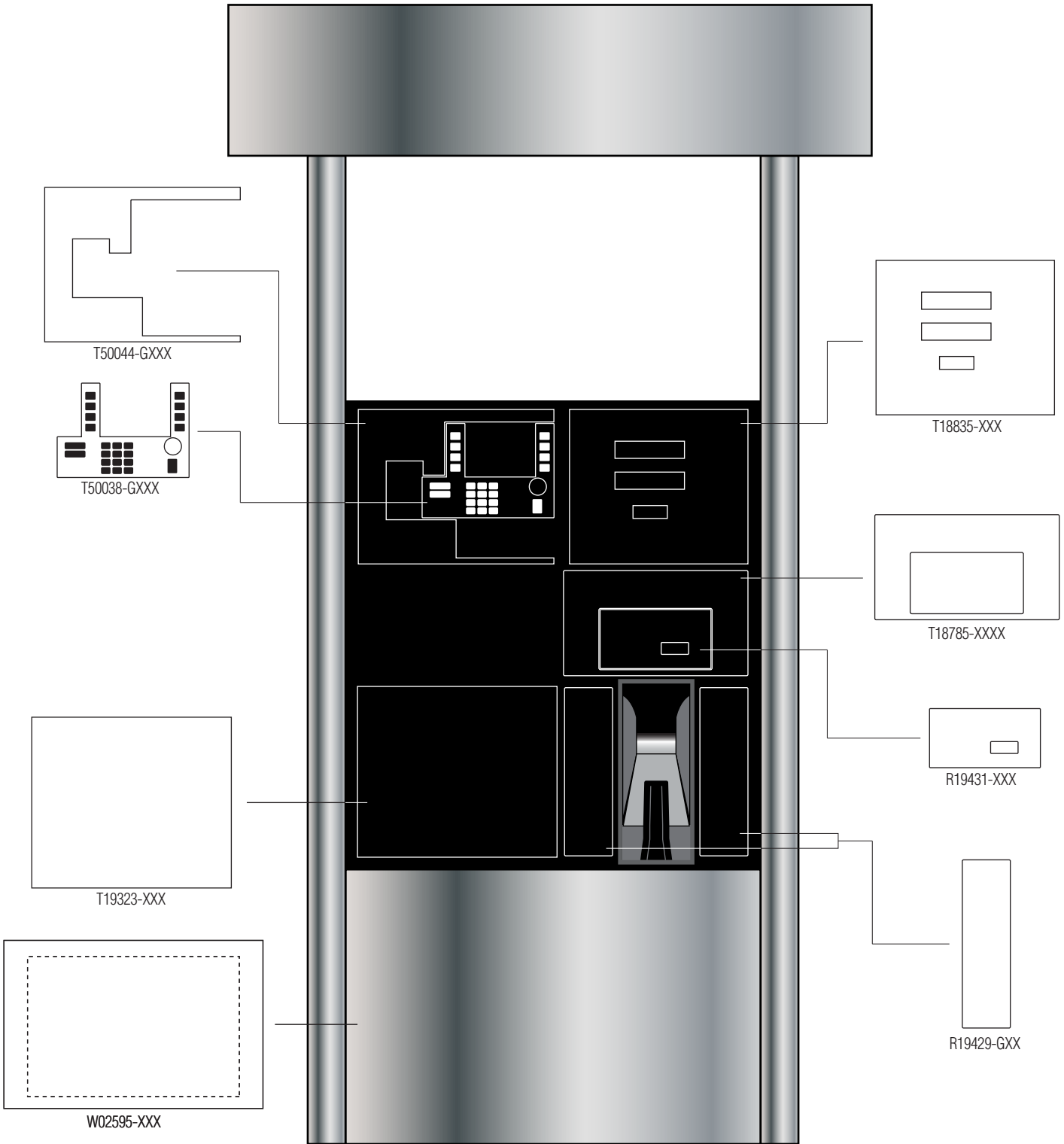



# GILBARCO ADVANTAGE B78

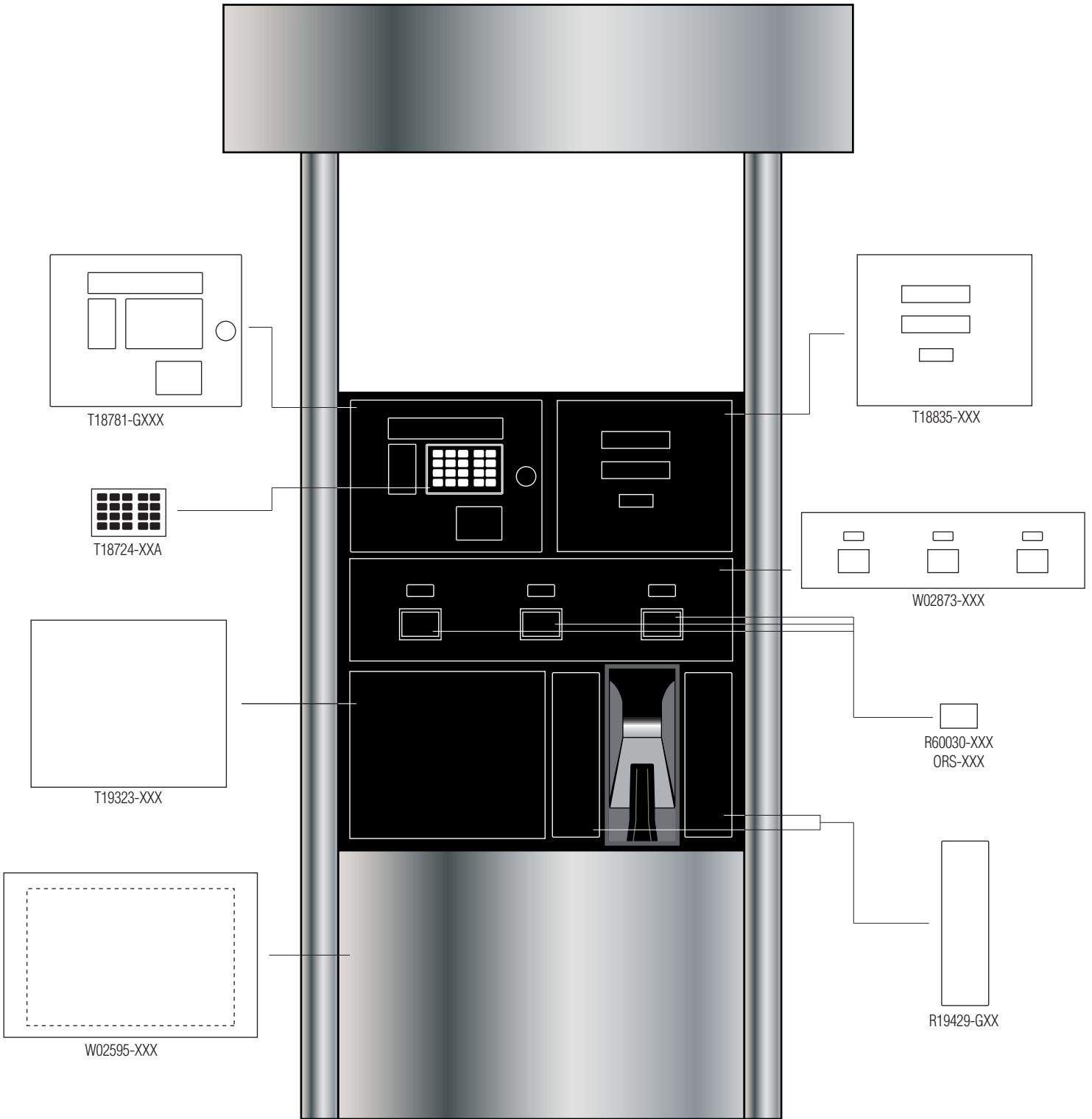

# GILBARCO ADVANTAGE B79 NON-OPTIMIZED

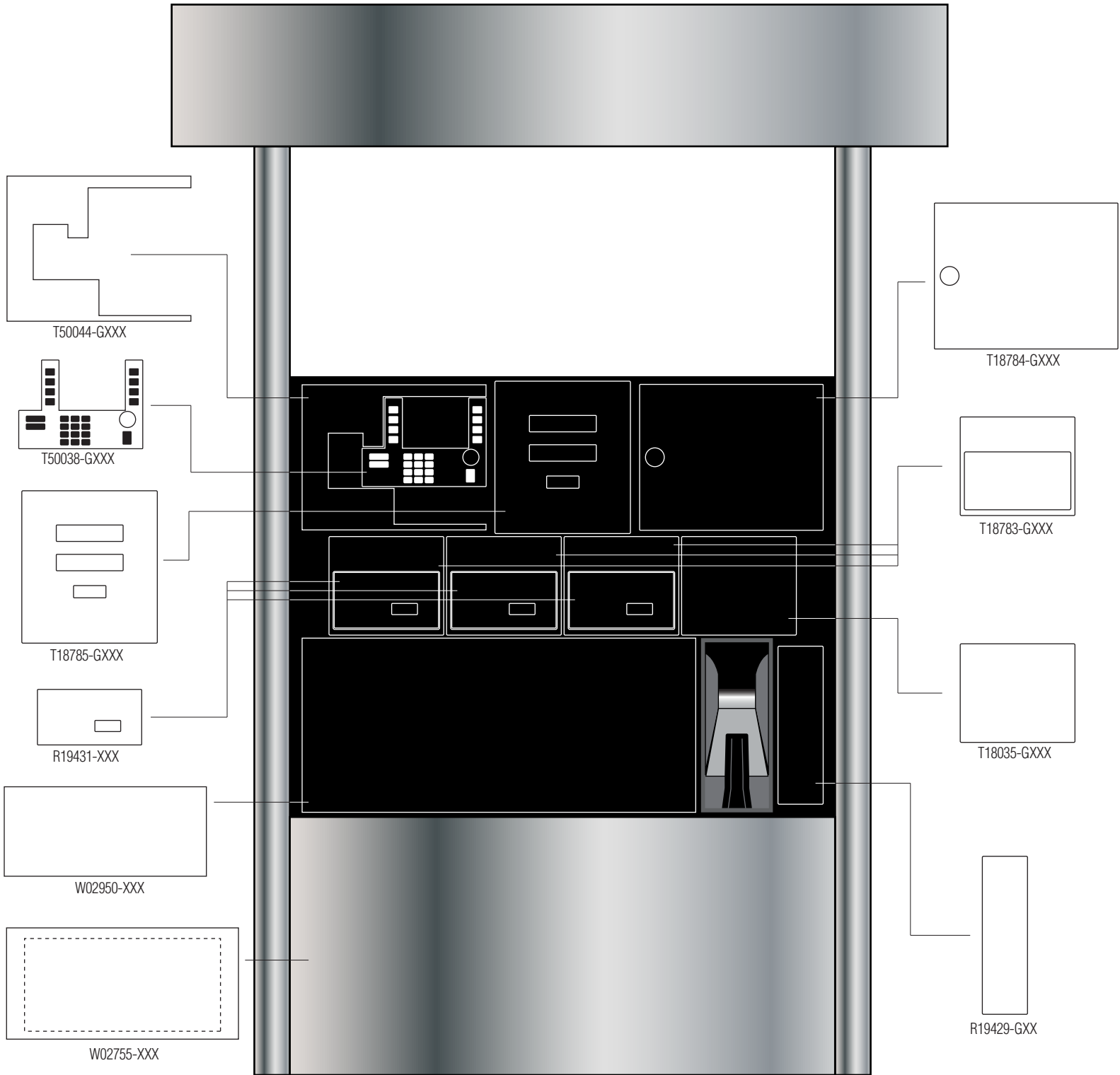

# GILBARCO ADVANTAGE B79 OPTIMIZED

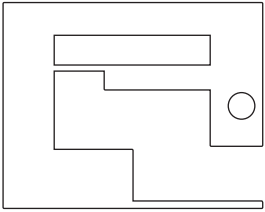

T50063-GXXX



T50064-XXX

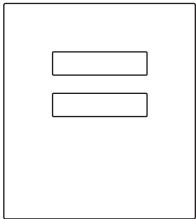

T18783-GXXX

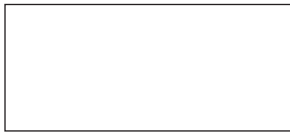

W02950-XXX



W02755-XXX

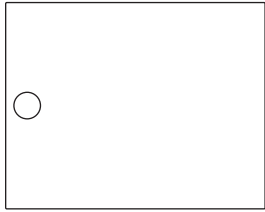

T18784-GXXX



W02872-XXX



R60030-XXX  
ORS-XXX



R19429-GXX

# ENCORE 1+0 GENERIC

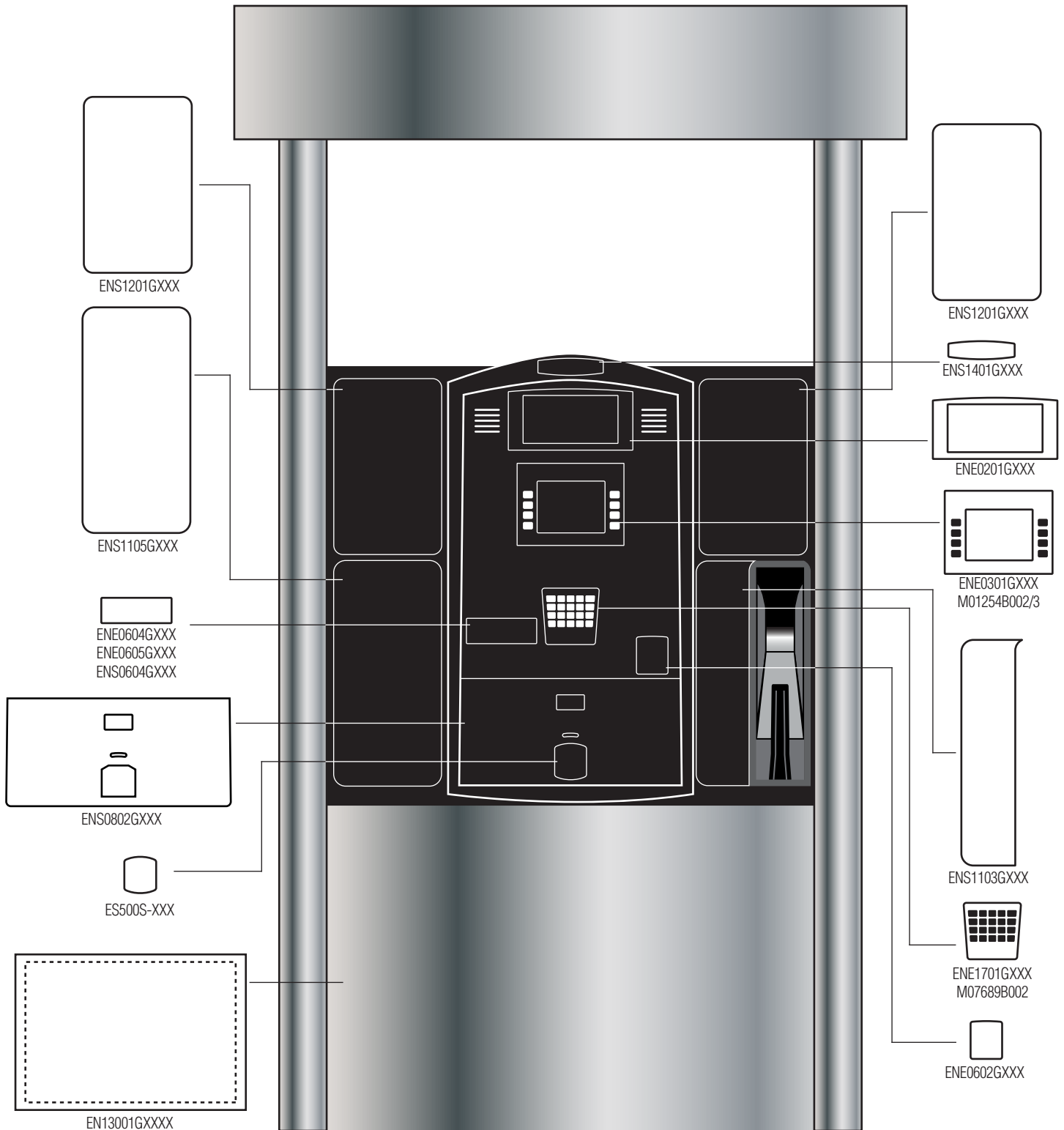

# ENCORE 3+0 EPP GENERIC

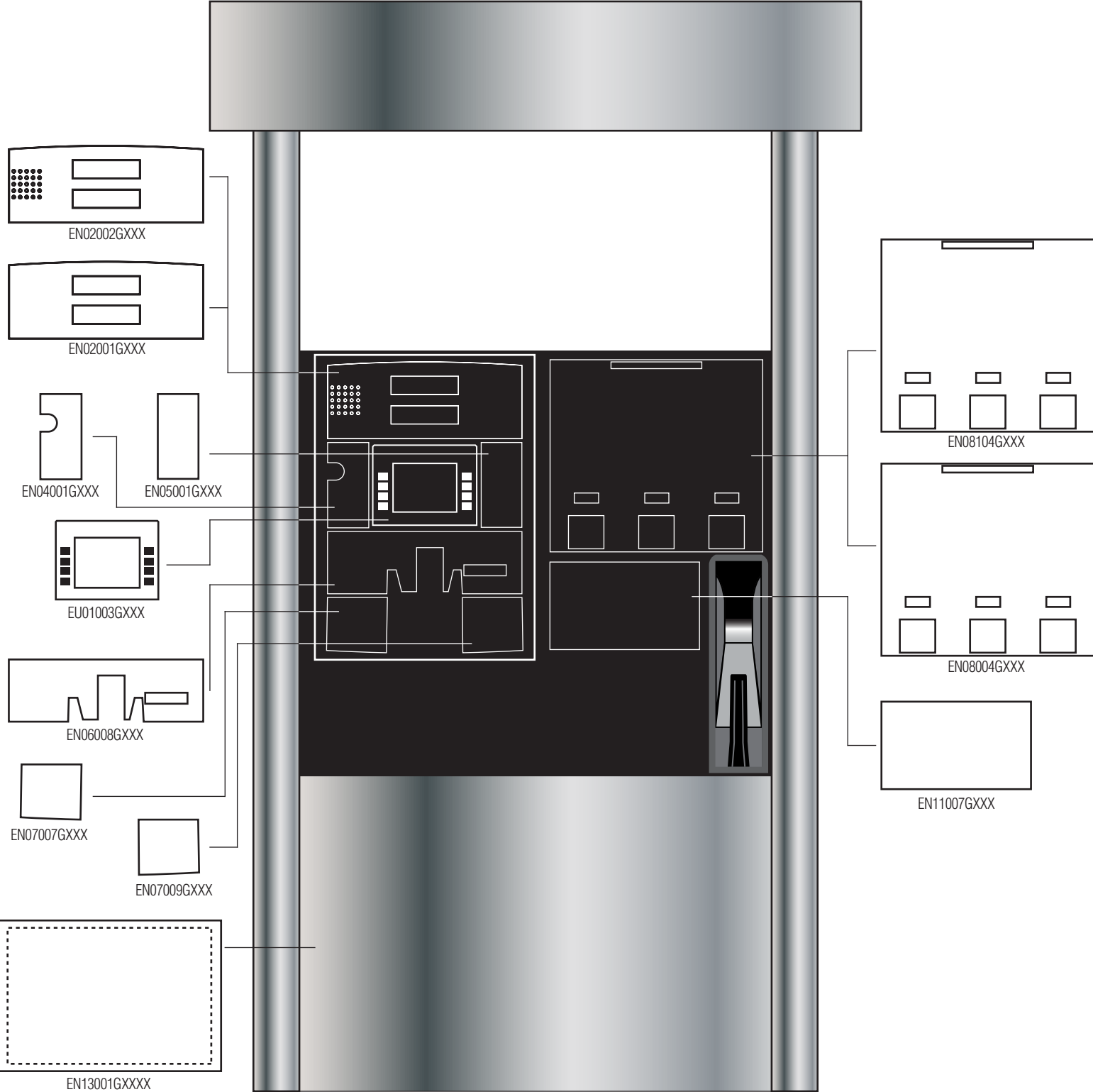

# ENCORE 3+0 GENERIC

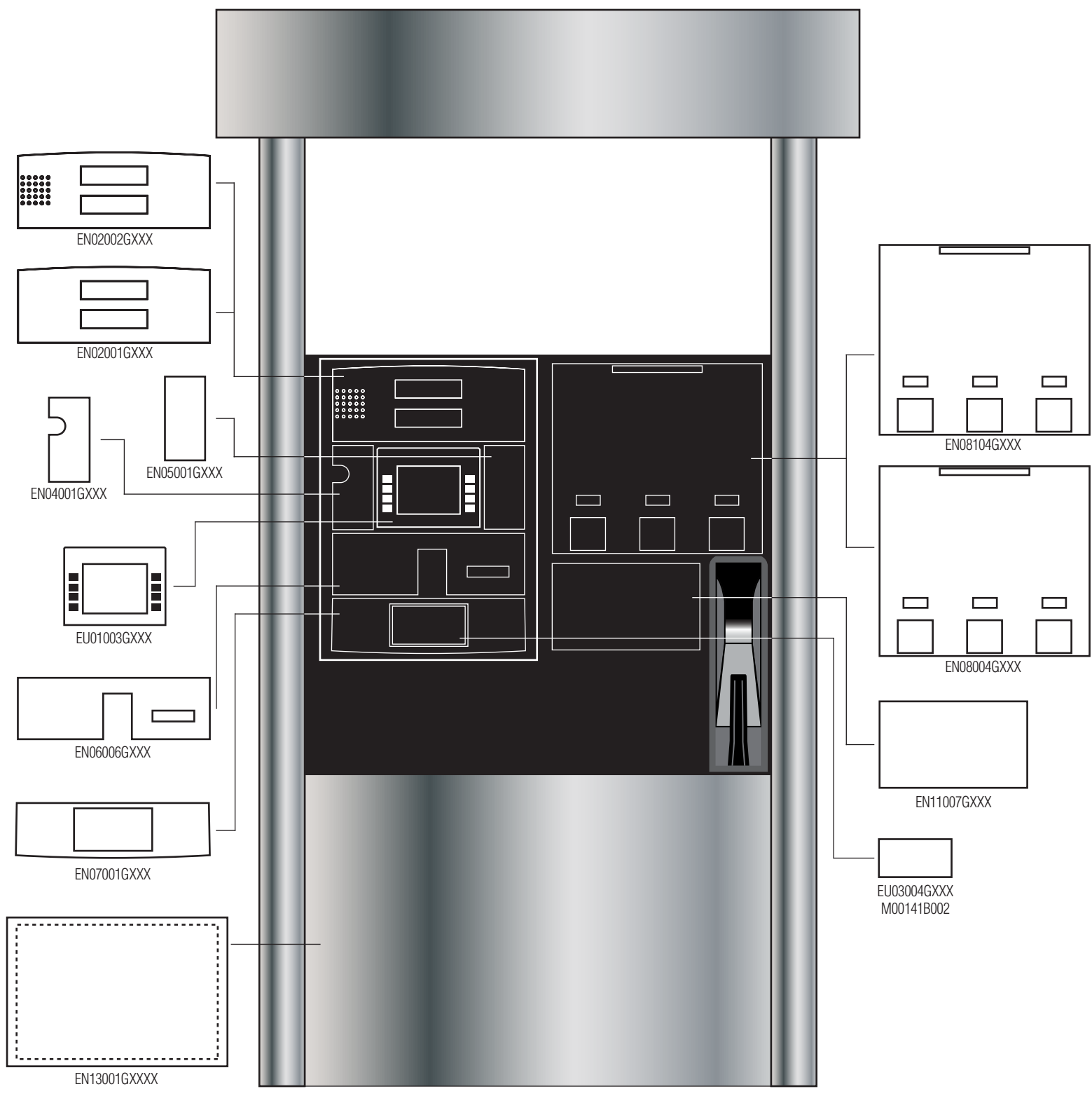

# ENCORE 3+1 GENERIC

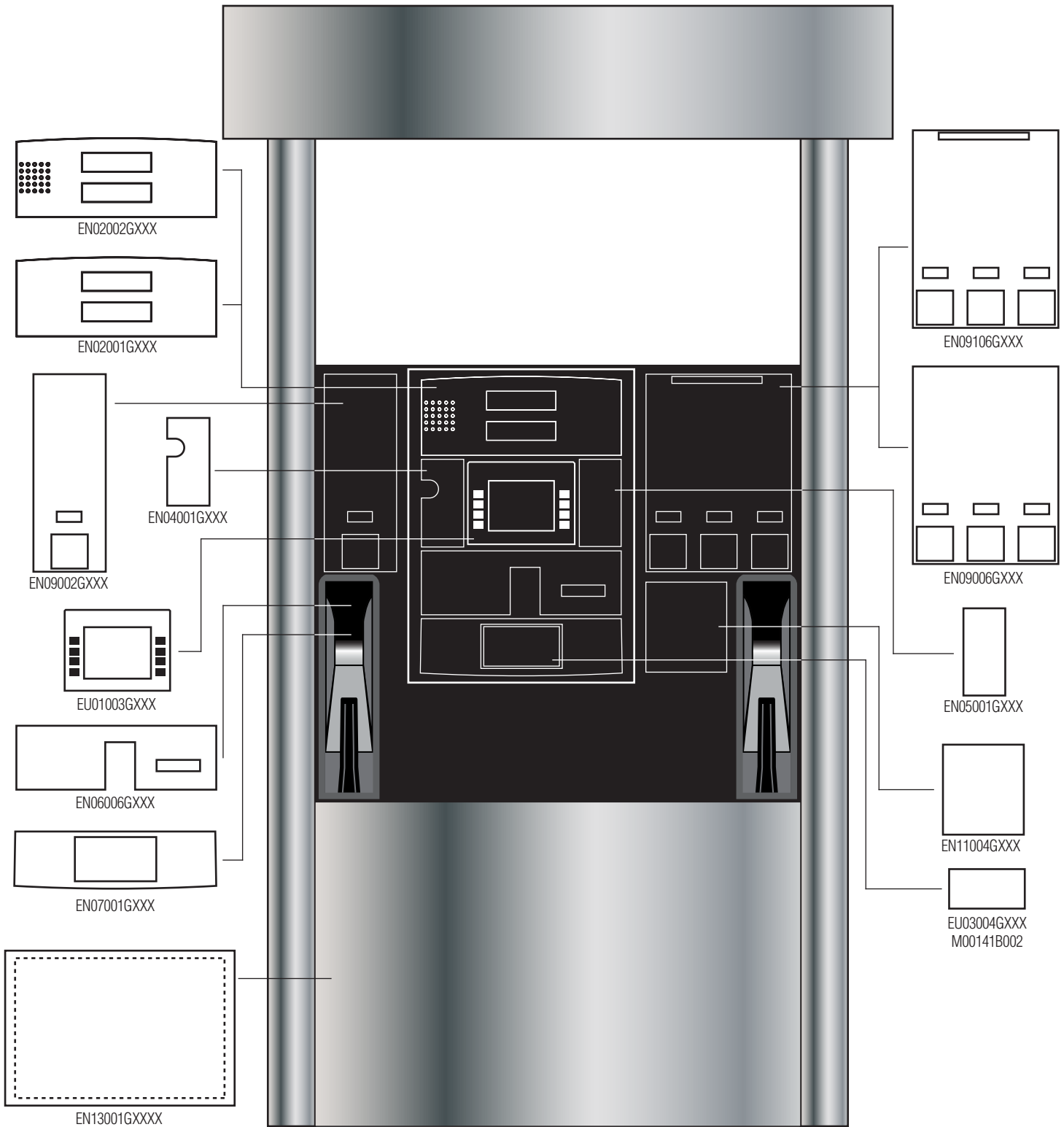

# ENCORE S 3+0 GENERIC

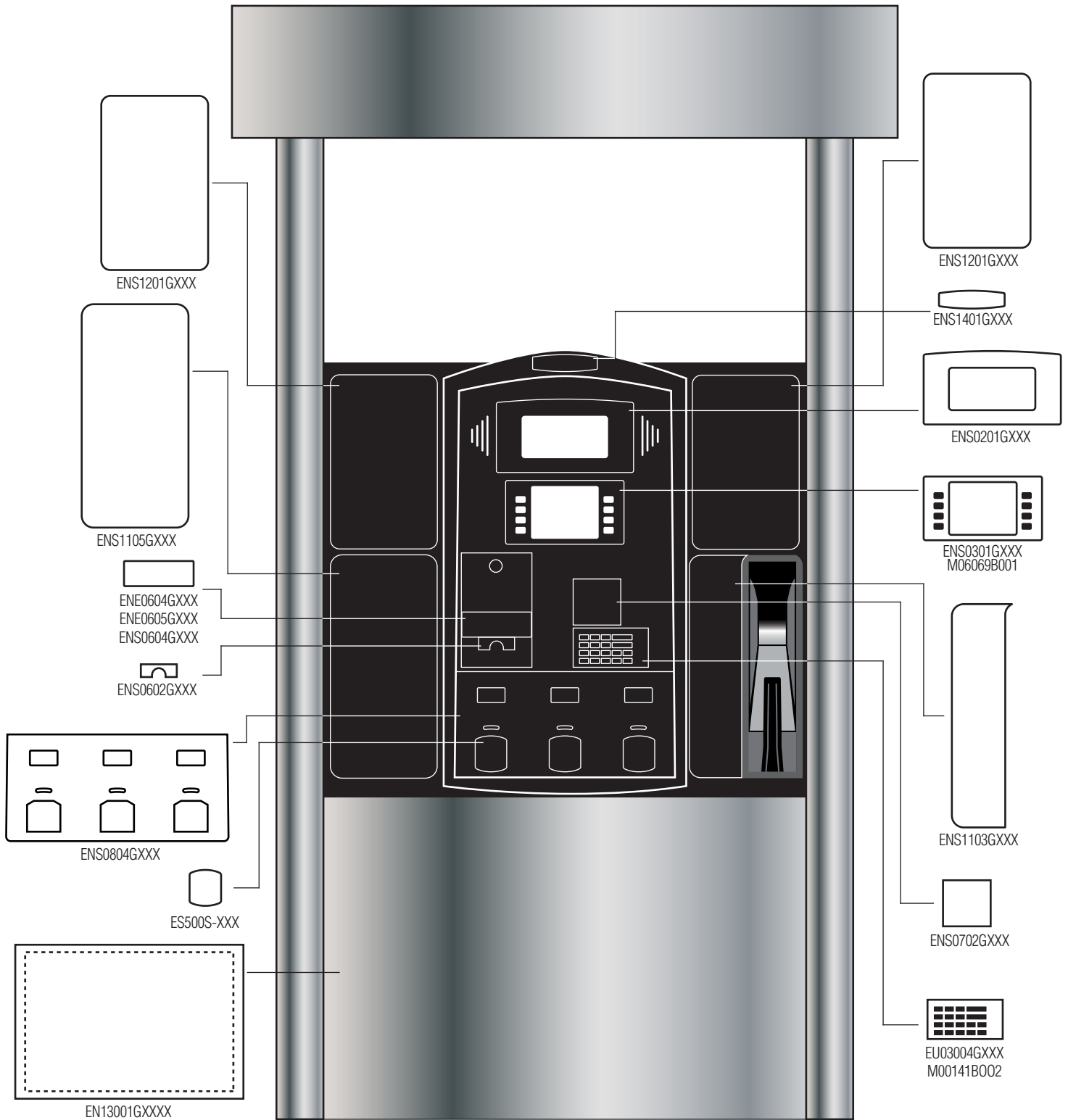



# ENCORE S ECIM 3+0 GENERIC

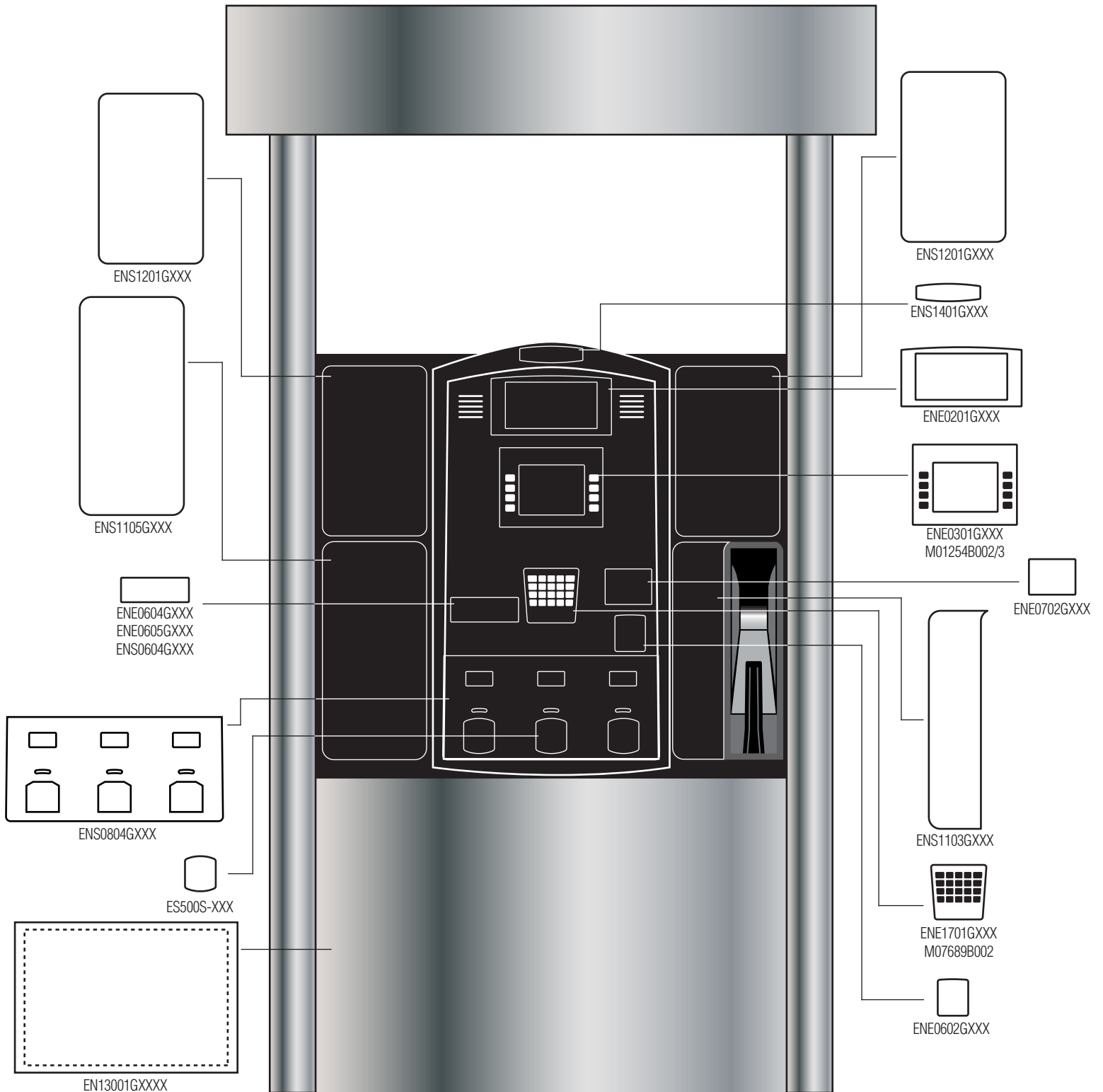

# ENCORE S ECIM 3+1 GENERIC

