

# GOLDEN STATE ORTHODONTIC SUPPLY



Phone: (408) 228-7552

Email: [info@goldenstateortho@gmail.com](mailto:info@goldenstateortho@gmail.com)

Web: [www.gsorthosupply.com](http://www.gsorthosupply.com)

# GOLDEN STATE ORTHODONTIC SUPPLY



## About Us

### Reliable Quality/Efficient Service

Why pay more when you can save? Golden State Orthodontic Supply started out in the San Francisco Bay Area and noticed offices were paying way too much on their supplies. We want to save you money, so you give back to your staff or your wonderful patients.



## Metal Brackets

● P 1-18

01



## Ceramic Brackets

● P 19-26

02



## Buccal Tubes

● P 27-34

03



## Molar Bands

● P 35-40

04



## Archwires

● P 41-46

05



## Elastics

● P 47-52

06



## Accessories

● P 53-60

07



## Ortho Tools

● P 61-66

08



## Ortho Care

● P 67-72

09



## Instruments

● P 73-78

10





# Orthodontic Brackets

Metal brackets / Self ligating bracket / Other metal bracket

# Self - Ligating

## Series X \$115.00

Interactive Self-ligating brackets. Made of 17-4 stainless steel.  
 MIM advance tech. Laser welding brings rigid strength and is nickel free.  
 Newest Aesthetic design. Contoured appearance for more comfort.  
 Laser mark base for easy identification.



### ■ Roth System

#### ✓ Maxillary

Torque	-7°	-7°	-2°	+8°	+12°	+12°	+8°	-2°	-7°	-7°
Tip	0°	0°	10°	9°	5°	5°	9°	10°	0°	0°
In/out mm	1.2	1.2	1.2	1.7	1.2	1.2	1.7	1.2	1.2	1.2
Width mm	3.2	3.2	3.2	3.0	3.6	3.6	3.0	3.2	3.2	3.2

#### ✓ Mandibular

Torque	-22°	-17°	-11°	-1°	-1°	-1°	-1°	-11°	-17°	-22°
Tip	0°	0°	7°	0°	0°	0°	0°	7°	0°	0°
In/out mm	1.2	1.2	1.2	1.7	1.7	1.7	1.7	1.2	1.2	1.2
Width mm	3.2	3.2	3.2	2.6	2.6	2.6	2.6	3.2	3.2	3.2

### ■ MBT System

#### ✓ Maxillary

Torque	-7°	-7°	-7°	+10°	+17°	+17°	+10°	-7°	-7°	-7°
Tip	0°	0°	8°	8°	4°	4°	8°	8°	0°	0°
In/out mm	0.7	0.7	0.7	1.05	0.7	0.7	1.05	0.7	0.7	0.7
Width mm	2.8	2.8	2.8	2.7	3.1	3.1	2.7	2.8	2.8	2.8

#### ✓ Mandibular

Torque	-17°	-12°	-6°	-6°	-6°	-6°	-6°	-6°	-12°	-17°
Tip	0°	0°	3°	0°	0°	0°	0°	3°	0°	0°
In/out mm	0.7	0.7	0.7	1.05	1.05	1.05	1.05	0.7	0.7	0.7
Width mm	2.8	2.8	2.8	2.5	2.5	2.5	2.5	2.8	2.8	2.8

Slot	Assortments pack	Quantity	3.4.5 with hook
0.022"	1kit	20pcs	accept

# Self-Ligating

## Series Y \$115.00

Self-ligating Brackets, made of hard 17-4 stainless steel, and MIM technology.

Passive self – ligating system.

Easy sliding pin makes ligating much easier.

Passive mechanical design can offer the lowest friction.

Make your orthodontic treatment easy and effective.



### ■ Roth System

✓ Maxillary

Torque	-7°	-7°	-2°	8°	18°	12°	8°	-2°	-7°	-7°
Tip	0°	0°	10°	9°	5°	5°	9°	10°	0°	0°

✓ Mandibular

Torque	-22°	-17°	-11°	-1°	-1°	-1°	-1°	-11°	-17°	-22°
Tip	0°	0°	7°	0°	0°	0°	0°	7°	0°	0°

### ■ MBT System

✓ Maxillary

Torque	-6°	-6°	-3°	12°	14°	14°	12°	-3°	-6°	-6°
Tip	2°	2°	7°	6°	4°	4°	6°	7°	2°	2°

✓ Mandibular

Torque	-21°	-16°	-3°	-5°	-5°	-5°	-5°	-3°	-16°	-21°
Tip	6°	6°	3°	0°	0°	0°	0°	3°	6°	6°



## ■ Low Torque System

✓ Maxillary

Torque	-6°	-6°	-8°	12°	14°	14°	12°	-8°	-6°	-6°
Tip	2°	2°	7°	6°	4°	4°	6°	7°	2°	2°

✓ Mandibular

Torque	-21°	-16°	0°	-5°	-5°	-5°	-5°	-0°	-16°	-21°
Tip	6°	6°	3°	0°	0°	0°	0°	3°	6°	6°

## ■ Standard Torque System

✓ Maxillary

Torque	-6°	-6°	-3°	12°	14°	14°	12°	-3°	-6°	-6°
Tip	2°	2°	7°	6°	4°	4°	6°	7°	2°	2°

✓ Mandibular

Torque	-21°	-16°	-3°	-5°	-5°	-5	-5°	-3°	-16°	-21°
Tip	6°	6°	3°	0°	0°	0°	0°	3°	0°	6°

## ■ High Torque System

✓ Maxillary

Torque	-6°	-6°	11°	17°	19°	19°	17°	11°	-6°	-6°
Tip	2°	2°	7°	6°	4°	4°	6°	7°	2°	2°

✓ Mandibular

Torque	-21°	-16°	12°	0°	0°	0°	0°	12°	-16°	-21°
Tip	6°	6°	3°	0°	0°	0°	0°	3°	6°	6°

Slot	Assortments pack	Quantity	3.4.5 with hook	3 with hook	No Hook
0.022"	1kit	20pcs	accept	accept	accept

# Self-Ligating

## Series Z \$115.00

Self-ligating Brackets, made of hard 17-4 stainless steel, and MIM technology.

Passive self – ligating system.

Easy sliding pin makes ligating much easier.

Passive mechanical design can offer the lowest friction.

Make your orthodontic treatment easy and affective.

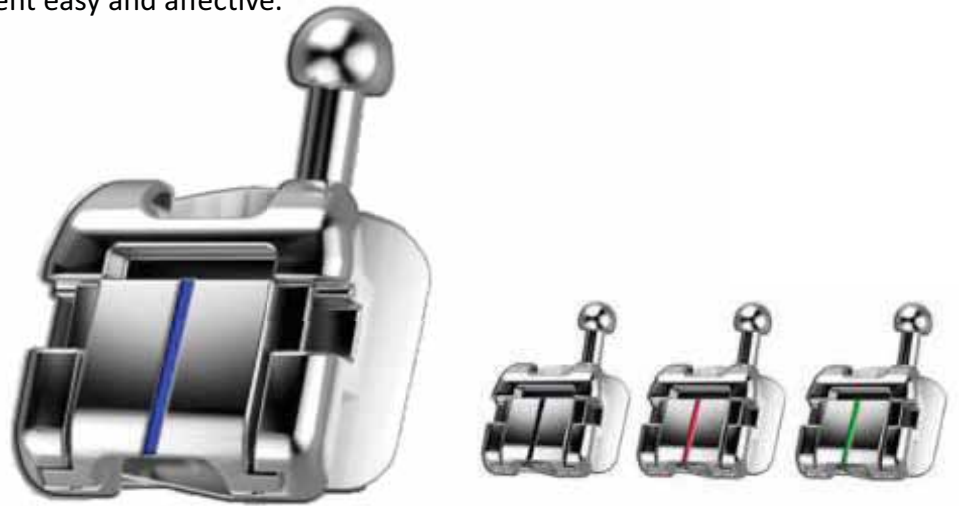

### ■ Roth System

✓ Maxillary

Torque	-7°	-7°	0°	+8°	+12°	+12°	+8°	0°	-7°	-7°
Tip	0°	0°	11°	9°	5°	5°	9°	11°	0°	0°
In/out mm	0.8	0.8	0.8	1.09	0.9	0.9	1.09	0.8	0.8	0.8
Width mm	2.8	2.8	2.8	2.8	3.0	3.0	2.8	2.8	2.8	2.8

✓ Mandibular

Torque	-22°	-17°	-11°	-1°	-1°	-1°	-1°	-11°	-17°	-22°
Tip	0°	0°	5°	0°	0°	0°	0°	5°	0°	0°
In/out mm	0.8	0.8	0.8	1.09	1.09	1.09	1.09	0.8	0.8	0.8
Width mm	2.8	2.8	2.8	2.5	2.5	2.5	2.5	2.8	2.8	2.8

### ■ MBT System

✓ Maxillary

Torque	-7°	-7°	-7°	+10°	+17°	+17°	+10°	-7°	-7°	-7°
Tip	0°	0°	8°	8°	4°	4°	8°	8°	0°	0°
In/out mm	0.8	0.8	0.8	1.09	0.9	0.9	1.09	0.8	0.8	0.8
Width mm	2.8	2.8	2.8	2.8	3.0	3.0	2.8	2.8	2.8	2.8

✓ Mandibular

Torque	-17°	-12°	-6°	-6°	-6°	-6°	-6°	-6°	-12°	-17°
Tip	0°	0°	3°	0°	0°	0°	0°	3°	0°	0°
In/out mm	0.8	0.8	0.8	1.09	1.09	1.09	1.09	0.8	0.8	0.8
Width mm	2.8	2.8	2.8	2.5	2.5	2.5	2.5	2.8	2.8	2.8





## ■ Standard Torque System

✓ Maxillary

Torque	-7°	-7°	0°	+8°	+12°	+12°	+8°	0°	-7°	-7°
Tip	0°	0°	11°	9°	5°	5°	9°	11°	0°	0°
In/out mm	0.8	0.8	0.8	1.09	0.9	0.9	1.09	0.8	0.8	0.8
Width mm	2.8	2.8	2.8	2.8	3.0	3.0	2.8	2.8	2.8	2.8

✓ Mandibular

Torque	-20°	-17°	-11°	-1°	-1°	-1°	-1°	-11°	-17°	-20°
Tip	0°	0°	5°	0°	0°	0°	0°	5°	0°	0°
In/out mm	0.8	0.8	0.8	1.09	1.09	1.09	1.09	0.8	0.8	0.8
Width mm	2.8	2.8	2.8	2.5	2.5	2.5	2.5	2.8	2.8	2.8

## ■ High Torque System

✓ Maxillary

Torque	-7°	-7°	+11°	+13°	+22°	+22°	+13°	+11°	-7°	-7°
Tip	0°	0°	11°	9°	5°	5°	9°	11°	0°	0°
In/out mm	0.8	0.8	0.8	1.09	0.9	0.9	1.09	0.8	0.8	0.8
Width mm	2.8	2.8	2.8	2.8	3.0	3.0	2.8	2.8	2.8	2.8

✓ Mandibular

Torque	-17°	-5°	+13°	-1°	-1°	-1°	-1°	+13°	-5°	-17°
Tip	0°	0°	5°	0°	0°	0°	0°	5°	0°	0°
In/out mm	0.8	0.8	0.8	1.09	1.09	1.09	1.09	0.8	0.8	0.8
Width mm	2.8	2.8	2.8	2.5	2.5	2.5	2.5	2.8	2.8	2.8

Slot	Assortments pack	Quantity	3.45 with hook	3 with hook	No Hook
0.022"	1kit	20pcs	accept	accept	accept

# Metal Brackets

## Mesh Base -- Series A \$25.00

Mesh base Brackets are made by MIM Technology.

Two piece construction made with the newest welding technology for a strong body and base.

80 thick mesh pad body for bonding.

Mesh Base is the most popular bracket in the market.

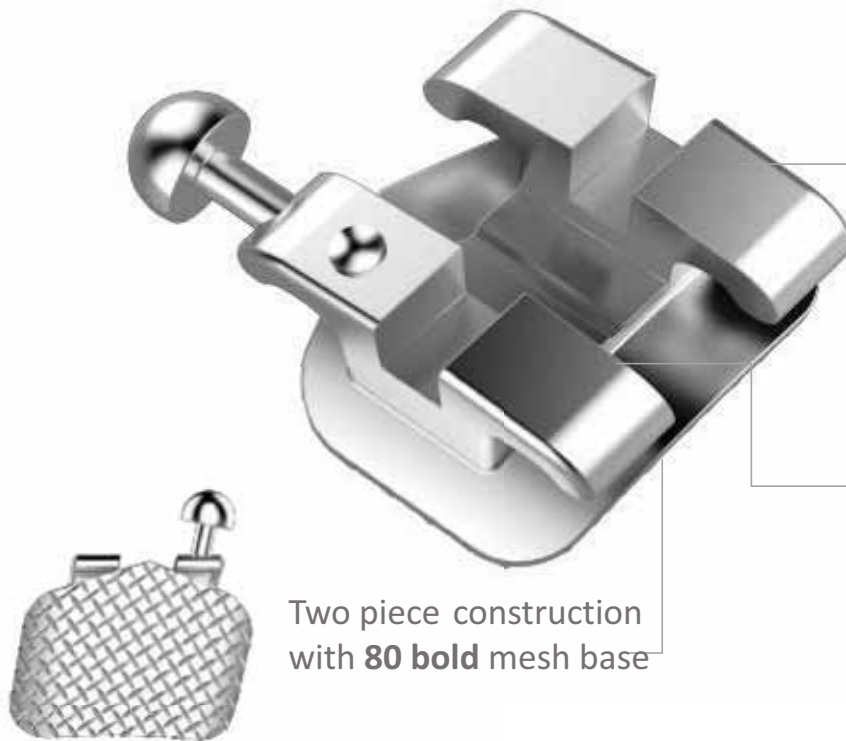

Low profile wing design for easy ligating

Hard 17-4 stainless steel metal

Industrial best 0.022 precision error

Two piece construction with **80 bold** mesh base

### ■ Roth System

### ■ Mini

### ■ Standard

✓ Maxillary

Torque	-7°	-7°	-2°	+8°	+12°	+12°	+8°	-2°	-7°	-7°
Tip	0°	0°	11°	9°	5°	5°	9°	11°	0°	0°
In/out mm	0.7	0.7	0.7	1.1	0.7	0.7	1.1	0.7	0.7	0.7
Width mm	2.8	2.8	2.8	2.8	3.2	3.2	2.8	2.8	2.8	2.8

✓ Mandibular

Torque	-22°	-17°	-11°	-1°	-1°	-1°	-1°	-11°	-17°	-22°
Tip	0°	0°	5°	0°	0°	0°	0°	5°	0°	0°
In/out mm	0.6	0.6	0.7	1.1	1.1	1.1	1.1	0.7	0.6	0.6
Width mm	2.8	2.8	2.8	2.3	2.3	2.3	2.3	2.8	2.8	2.8

## ■ MBT System

■ Mini

■ Standard

✓ Maxillary

Torque	-7°	-7°	-7°	+10°	+17°	+17°	+10°	-7°	-7°	-7°
Tip	0°	0°	8°	8°	4°	4°	8°	8°	0°	0°
In/out mm	0.7	0.7	0.7	1.1	0.7	0.7	1.1	0.7	0.7	0.7
Width mm	2.8	2.8	2.8	2.6	3.0	3.0	2.6	2.8	2.8	2.8

✓ Mandibular

Torque	-17°	-12°	-6°	-6°	-6°	-6°	-6°	-6°	-12°	-17°
Tip	0°	0°	3°	0°	0°	0°	0°	3°	0°	0°
In/out mm	0.7	0.7	0.7	1.1	1.1	1.1	1.1	0.7	0.7	0.7
Width mm	2.8	2.8	2.8	2.3	2.3	2.3	2.3	2.8	2.8	2.8

## ■ Edgewise System

■ Mini

■ Standard

✓ Maxillary

Torque	0°	0°	0°	0°	0°	0°	0°	0°	0°	0°
Tip	0°	0°	0°	0°	0°	0°	0°	0°	0°	0°
In/out mm	0.7	0.7	0.7	0.7	0.7	0.7	0.7	0.7	0.7	0.7
Width mm	2.9	2.9	2.9	2.8	3.1	3.1	2.8	2.9	2.9	2.9

✓ Mandibular

Torque	0°	0°	0°	0°	0°	0°	0°	0°	0°	0°
Tip	0°	0°	0°	0°	0°	0°	0°	0°	0°	0°
In/out mm	0.7	0.7	0.7	0.7	0.7	0.7	0.7	0.7	0.7	0.7
Width mm	2.9	2.9	2.9	2.3	2.3	2.3	2.3	2.9	2.9	2.9

Slot	Assortments pack	Quantity	No hook	3 with hook	3.4.5 with hook
0.022"	1kit	20pcs	accept	accept	accept
0.018"	1kit	20pcs	accept	accept	accept

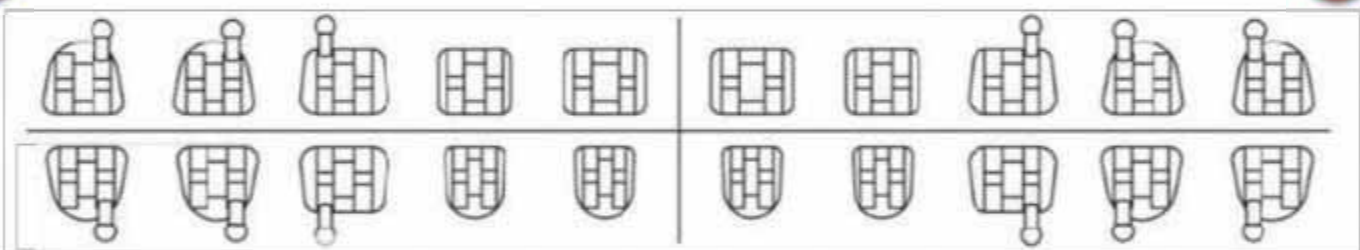

# Metal Brackets

## Monoblock -- Series B \$25.00

Monoblock brackets are made by the newest and advanced technology of metal injection molding.

One piece construction, never worry about bonding pad separating from brackets. Monoblock brackets are sandblasted with a micro etched base.

MIM Technology  
Round Ball  
Color cade



Lower profile,  
Accuracy slot for  
lower friction, hard  
17-4 stainless steel



### ■ Roth System

✓ Maxillary

Torque	-7°	-7°	-2°	+8°	+12°	+12°	+8°	-2°	-7°	-7°
Tip	0°	0°	11°	9°	5°	5°	9°	11°	0°	0°
In/out mm	0.7	0.7	0.7	1.1	0.7	0.7	1.1	0.7	0.7	0.7
Width mm	2.8	2.8	2.8	2.6	3.0	3.0	2.6	2.8	2.8	2.8

✓ Mandibular

Torque	-22°	-17°	-11°	-1°	-1°	-1°	-1°	-11°	-17°	-22°
Tip	0°	0°	5°	0°	0°	0°	0°	5°	0°	0°
In/out mm	0.6	0.6	0.7	1.1	1.1	1.1	1.1	0.7	0.6	0.6
Width mm	2.8	2.8	2.8	2.3	2.3	2.3	2.3	2.8	2.8	2.8

## ■ MBT System

✓ Maxillary

Torque	-7°	-7°	-7°	+10°	+17°	+17°	+10°	-7°	-7°	-7°
Tip	0°	0°	8°	8°	4°	4°	8°	8°	0°	0°
In/out mm	0.7	0.7	0.7	1.1	0.7	0.7	1.1	0.7	0.7	0.7
Width mm	2.8	2.8	2.8	2.6	3.0	3.0	2.6	2.8	2.8	2.8

✓ Mandibular

Torque	-17°	-12°	-6°	-6°	-6°	-6°	-6°	-6°	-12°	-17°
Tip	0°	0°	3°	0°	0°	0°	0°	3°	0°	0°
In/out mm	0.7	0.7	0.7	1.1	1.1	1.1	1.1	0.7	0.7	0.7
Width mm	2.8	2.8	2.8	2.3	2.3	2.3	2.3	2.8	2.8	2.8

## ■ Edgewise System

✓ Maxillary

Torque	0°	0°	0°	0°	0°	0°	0°	0°	0°	0°
Tip	0°	0°	0°	0°	0°	0°	0°	0°	0°	0°
In/out mm	0.7	0.7	0.7	0.7	0.7	0.7	0.7	0.7	0.7	0.7
Width mm	2.6	2.6	2.8	2.6	2.8	2.8	2.6	2.8	2.6	2.6

✓ Mandibular

Torque	0°	0°	0°	0°	0°	0°	0°	0°	0°	0°
Tip	0°	0°	0°	0°	0°	0°	0°	0°	0°	0°
In/out mm	0.7	0.7	0.7	0.7	0.7	0.7	0.7	0.7	0.7	0.7
Width mm	2.6	2.6	2.8	2.3	2.3	2.3	2.3	2.8	2.6	2.6

Slot	Assortments pack	Quantity	No hook	3 with hook	3.4.5 with hook
0.022"	1kit	20pcs	accept	accept	accept
0.018"	1kit	20pcs	accept	accept	accept

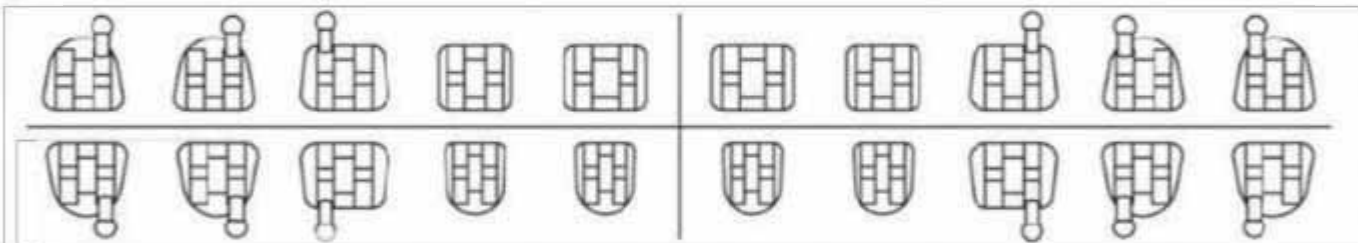

# Metal Brackets

## Mesh Base -- Series C \$25.00

Mesh base Brackets are made by CNC Technology.

Two piece construction made with the newest welding technology for a strong body and base.

80 thick mesh pad body for bonding.

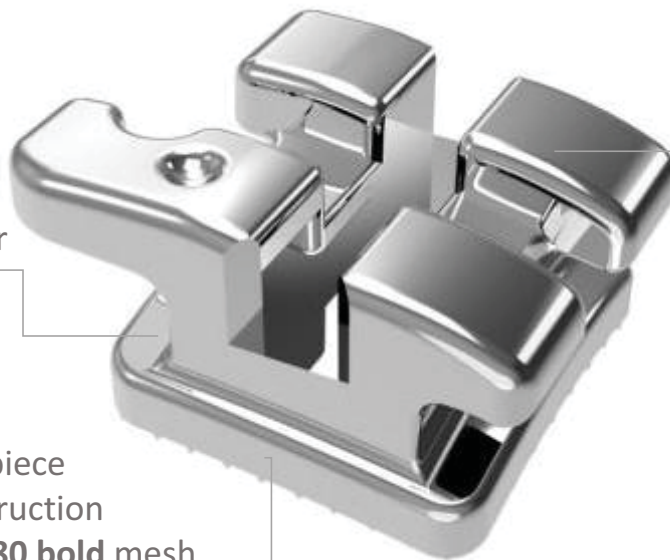

Low profile wing design for easy ligating

Hard 17-4 stainless steel metal

CNC Hand Made  
0.022 precision error

Two piece construction with **80 bold** mesh base



## ■ MBT System

✓ Maxillary

Torque	-7°	-7°	-7°	+10°	+17°	+17°	+10°	-7°	-7°	-7°
Tip	0°	0°	8°	8°	4°	4°	8°	8°	0°	0°
In/out mm	0.7	0.7	0.7	1.1	0.7	0.7	1.1	0.7	0.7	0.7
Width mm	2.8	2.8	2.8	2.6	3.0	3.0	2.6	2.8	2.8	2.8

✓ Mandibular

Torque	-17°	-12°	-6°	-6°	-6°	-6°	-6°	-6°	-12°	-17°
Tip	0°	0°	3°	0°	0°	0°	0°	3°	0°	0°
In/out mm	0.7	0.7	0.7	1.1	1.1	1.1	1.1	0.7	0.7	0.7
Width mm	2.8	2.8	2.8	2.3	2.3	2.3	2.3	2.8	2.8	2.8

Slot	Assortments pack	Quantity	3 with hook
0.022"	1kit	20pcs	accept

# Metal Brackets

## Monoblock -- Series D \$25.00

One piece construction bracket system, never worry about bonding pad separating from brackets.

When most of the one-piece construction on the market has less bonding around 15-17 newton, ours has 30+ newton bond strength.

MIM technology  
made of 17-4  
Stainless steel.

Lower profile,  
design for easy  
ligating

Industrial best  
0.002 precision  
error

Sand Blasted Base



Slot	Assortments pack	Quantity	3 with hook	3.4.5 with hook
0.022"	1kit	20pcs	accept	accept
0.018"	1kit	20pcs	accept	accept



## ■ Roth System

✓ Maxillary

Torque	-7°	-7°	-2°	+8°	+12°	+12°	+8°	-2°	-7°	-7°
Tip	0°	0°	11°	9°	5°	5°	9°	11°	0°	0°
In/out mm	0.7	0.7	0.7	1.1	0.7	0.7	1.1	0.7	0.7	0.7
Width mm	2.8	2.8	2.8	2.6	3.0	3.0	2.6	2.8	2.8	2.8

✓ Mandibular

Torque	-22°	-17°	-11°	-1°	-1°	-1°	-1°	-11°	-17°	-22°
Tip	0°	0°	5°	0°	0°	0°	0°	5°	0°	0°
In/out mm	0.6	0.6	0.7	1.1	1.1	1.1	1.1	0.7	0.6	0.6
Width mm	2.8	2.8	2.8	2.3	2.3	2.3	2.3	2.8	2.8	2.8

## ■ MBT System

✓ Maxillary

Torque	-7°	-7°	-7°	+10°	+17°	+17°	+10°	-7°	-7°	-7°
Tip	0°	0°	8°	8°	4°	4°	8°	8°	0°	0°
In/out mm	0.7	0.7	0.7	1.1	0.7	0.7	1.1	0.7	0.7	0.7
Width mm	2.8	2.8	2.8	2.6	3.0	3.0	2.6	2.8	2.8	2.8

✓ Mandibular

Torque	-17°	-12°	-6°	-6°	-6°	-6°	-6°	-6°	-12°	-17°
Tip	0°	0°	3°	0°	0°	0°	0°	3°	0°	0°
In/out mm	0.7	0.7	0.7	1.1	1.1	1.1	1.1	0.7	0.7	0.7
Width mm	2.8	2.8	2.8	2.3	2.3	2.3	2.3	2.8	2.8	2.8

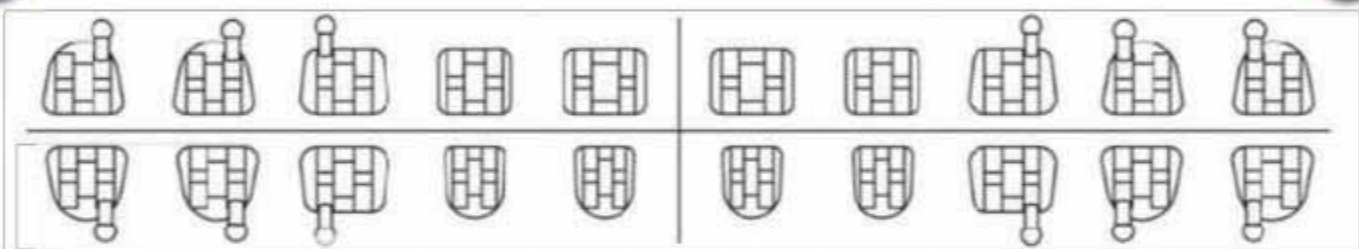

# V-slot Metal Brackets - Series V \$50.00

Product design features: Vertical slot brackets are mesh base made of 17-4 hard stainless steel. Advanced CNC

Two piece welding brackets; 80 mesh thick pads are flawless and welded to the brackets body by a laser beam.

A Vertical slot design for ligating.



## ■ Roth System

✓ Maxillary

Torque	-7°	-7°	-2°	+8°	+12°	+12°	+8°	-2°	-7°	-7°
Tip	0°	0°	11°	9°	5°	5°	9°	11°	0°	0°
In/out mm	0.9	0.9	0.9	1.25	0.9	0.9	1.25	0.9	0.9	0.9
Width mm	2.8	2.8	2.8	2.8	3.2	3.2	2.8	2.8	2.8	2.8

✓ Mandibular

Torque	-22°	-17°	-11°	-1°	-1°	-1°	-1°	-11°	-17°	-22°
Tip	0°	0°	5°	0°	0°	0°	0°	5°	0°	0°
In/out mm	0.9	0.9	0.9	1.2	1.2	1.2	1.2	0.9	0.9	0.9
Width mm	2.8	2.8	2.8	2.5	2.5	2.5	2.5	2.8	2.8	2.8

## ■ MBT System

✓ Maxillary

Torque	-7°	-7°	-7°	+10°	+17°	+17°	+10°	-7°	-7°	-7°
Tip	0°	0°	8°	8°	4°	4°	8°	8°	0°	0°
In/out mm	0.9	0.9	0.9	1.25	0.9	0.9	1.25	0.9	0.9	0.9
Width mm	2.8	2.8	2.9	2.8	3.1	3.1	2.8	2.9	2.8	2.8

✓ Mandibular

Torque	-17°	-12°	-6°	-6°	-6°	-6°	-6°	-6°	-17°	-17°
Tip	0°	0°	3°	0°	0°	0°	0°	3°	0°	0°
In/out mm	0.9	0.9	0.9	1.2	1.2	1.2	1.2	0.9	0.9	0.9
Width mm	2.8	2.8	2.9	2.5	2.5	2.5	2.5	2.9	2.8	2.8

Slot	Assortments pack	Quantity	3.4.5 with hook
0.022"	1kit	20pcs	accept

# 1st Molar Brackets \$10.00 Per Pack of 4

Molar Brackets are made by MIM technology, and have two piece construction. Made with the newest welding technology for a strong body and base. 80 thick mesh pads for bonding.



## ■ Edgewise Molar Brackets

Tooth	UR	UL	LL	LR
Torque	0°	0°	0°	0°
Tip	0°	0°	0°	0°
In/out mm	0.5	0.5	0.5	0.5
Width mm	4.0	4.0	4.0	4.0

## ■ Roth Molar Brackets

Tooth	UR	UL	LL	LR
Torque	-14°	-14°	-25°	-25°
Tip	+10°	+10°	+4°	+4°
In/out mm	0.5	0.5	0.5	0.5
Width mm	4.0	4.0	4.0	4.0

## ■ MBT Molar Brackets

Tooth	UR	UL	LL	LR
Torque	-14°	-14°	-20°	-20°
Tip	+10°	+10°	0°	0°
In/out mm	0.5	0.5	0.5	0.5
Width mm	4.0	4.0	4.0	4.0

Slot	Assortments pack	Quantity	With hook	No Hook
0.022"	1kit	4pcs	accept	accept
0.018"	1kit	4pcs	accept	accept

# Lingual Brackets - Series L \$115.00

Lingual brackets are our second generation for invisible lingual treatments.

Lingual system is made with CNC technology and hard stainless steel metal.

Lingual Brackets are most effective lingual brackets system in the market and need professional skill to operate.



Hook On	Items
Description	0.018" / 0.022"
Upper/lower 7-7 hook on 4 5 6 7	1kit

Tooth Position	Torq	Ang.	0.018" slot	0.022" slot
Central Lateral & Cuspid	-55	0	28pcs/set	28pcs/set
Lower Anterior & Cuspid	-44	0	28pcs/set	28pcs/set
Upper / Lower cuspid	-11	0	28pcs/set	28pcs/set

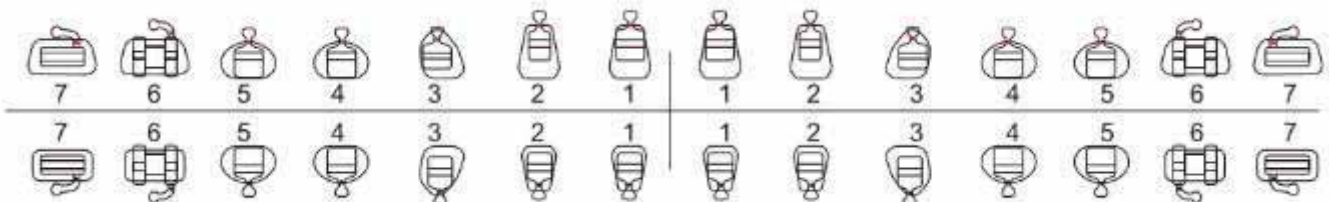

# Alexander Brackets - Series R \$55.00

Alexander brackets are made by MIM technology. Two piece construction.  
Our newest welding technology makes a strong body and base.  
80 thick mesh pad for bonding.



## ✓ Maxillary

Torque	-7°	-7°	-3°	+7°	+14°	+14°	+7°	-3°	-7°	-7°
Tip	0°	0°	10°	8°	5°	5°	8°	10°	0°	0°
In/out mm	1	1	1	1.2	1	1	1.2	1	1	1
Width mm	5	5	6.7	3.1	3.5	3.5	3.1	6.7	5	5

## ✓ Mandibular

Torque	-17°	-11°	-7°	-5°	-5°	-5°	-5°	-7°	-11°	-17°
Tip	0°	0°	6°	0°	0°	0°	0°	6°	0°	0°
In/out mm	0.9	0.9	0.9	1.3	1.3	1.3	1.3	0.9	0.9	0.9
Width mm	5	5	6.7	4.5	4.5	4.5	4.5	6.7	5	5

Slot	Assortments pack	Quantity	3.4.5 with hook
0.022"	1kit	20pcs	accept
0.018"	1kit	20pcs	accept

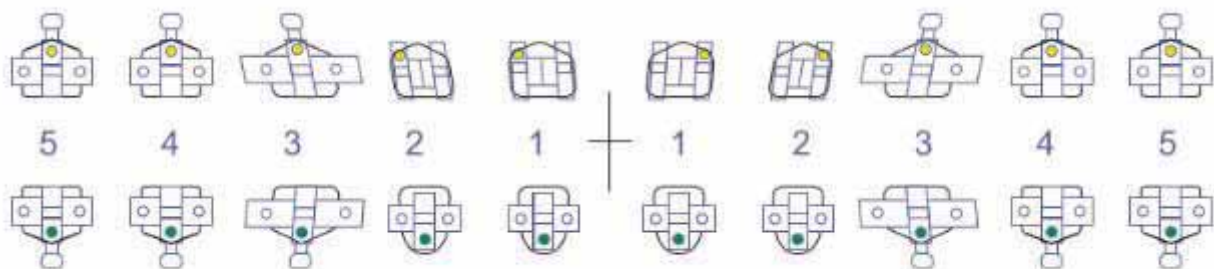



## Ceramic Bracket

Sapphire brackets / Self ligating bracket / Ceramic Monoblock

# Sapphire

## Sapphire Brackets - Series S \$250.00

Sapphire brackets are the perfect mono-crystalline brackets.

Plasma silica coating on the slot and full body.

Brings low friction and maintains a hard surface. Transparent and strong bonding.

High quality  
monocrystalline  
sapphire

Double fusion method  
base treatment

Smooth, strong and  
contoured tie wings.

Diamond and heat  
polished wire slot  
0.022" / 0.018"

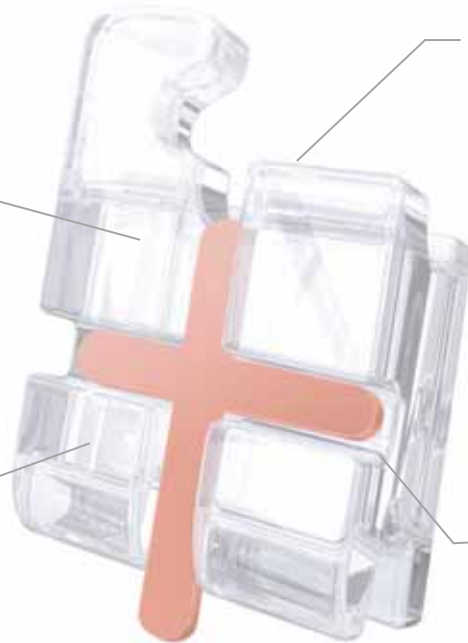

### ■ Roth System

#### ✓ Maxillary

Torque	-7°	-7°	-2°	+8°	+12°	+12°	+8°	-2°	-7°	-7°
Tip	0°	0°	11°	9°	5°	5°	9°	11°	0°	0°
Width mm	3.2	3.2	3.2	3.0	3.6	3.6	3.0	3.2	3.2	3.2

#### ✓ Mandibular

Torque	-22°	-17°	-11°	-1°	-1°	-1°	-1°	-11°	-17°	-22°
Tip	0°	0°	7°	0°	0°	0°	0°	7°	0°	0°
Width mm	3.2	3.2	3.2	2.6	2.6	2.6	2.6	3.2	3.2	3.2

### ■ MBT System

#### ✓ Maxillary

Torque	-7°	-7°	-7°	+10°	+17°	+17°	+10°	-7°	-7°	-7°
Tip	0°	0°	8°	8°	4°	4°	8°	8°	0°	0°
Width mm	3.4	3.4	3.4	3.8	3.8	3.8	3.8	3.4	3.4	3.4

#### ✓ Mandibular

Torque	-17°	-12°	-6°	-6°	-6°	-6°	-6°	-6°	-12°	-17°
Tip	2°	2°	3°	0°	0°	0°	0°	3°	2°	2°
Width mm	3.4	3.4	3.4	3.0	3.0	3.0	3.0	3.4	3.4	3.4

Slot	Assortments pack	Quantity	3 with hook	3.4.5 with hook
0.022"	1kit	20pcs	accept	accept
0.018"	1kit	20pcs	accept	accept

# Ceramic Brackets

## Three Groove - Series G \$90.00

The latest design three groove bonding base aesthetic brackets.

Made of poly-crystalline for the aesthetic ceramic bracket we use the ceramic injection molding technology.

With the effective performance and reasonable price.

Poly-crystalline,  
ceramic aesthetic,  
and CIM technology

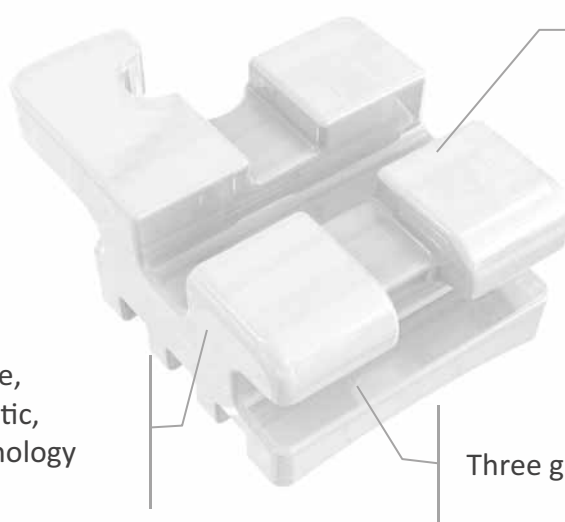

Smooth polished  
round edges and  
precise slots brings  
comfort for your patient.



Three groove base which makes bonding solid.

### ■ Roth System

#### ✓ Maxillary

Torque	-7°	-7°	-2°	+8°	+12°	+12°	+8°	-2°	-7°	-7°
Tip	0°	0°	10°	9°	5°	5°	9°	10°	0°	0°
In/out mm	1.2	1.2	1.2	1.7	1.2	1.2	1.7	1.2	1.2	1.2
Width mm	3.2	3.2	3.2	3.0	3.6	3.6	3.0	3.2	3.2	3.2

#### ✓ Mandibular

Torque	-22°	-17°	-11°	-1°	-1°	-1°	-1°	-11°	-17°	-22°
Tip	0°	0°	7°	0°	0°	0°	0°	7°	0°	0°
In/out mm	1.2	1.2	1.2	1.7	1.7	1.7	1.7	1.2	1.2	1.2
Width mm	3.2	3.2	3.2	2.6	2.6	2.6	2.6	3.2	3.2	3.2

### ■ MBT System

#### ✓ Maxillary

Torque	-7°	-7°	-7°	+10°	+17°	+17°	+10°	-7°	-7°	-7°
Tip	0°	0°	8°	8°	4°	4°	8°	8°	0°	0°
In/out mm	1.1	1.1	1.1	1.4	1.2	1.2	1.4	1.1	1.1	1.1
Width mm	3.4	3.4	3.4	3.8	3.8	3.8	3.8	3.4	3.4	3.4

#### ✓ Mandibular

Torque	-17°	-12°	-6°	-6°	-6°	-6°	-6°	-6°	-12°	-17°
Tip	2°	2°	3°	0°	0°	0°	0°	3°	2°	2°
In/out mm	1.1	1.1	1.1	1.3	1.3	1.3	1.3	1.1	1.1	1.1
Width mm	3.4	3.4	3.4	3.0	3.0	3.0	3.0	3.4	3.4	3.4

Slot	Assortments pack	Quantity	3.4.5 with hook
0.022"	1kit	20pcs	accept
0.018"	1kit	20pcs	accept



# Ceramic Brackets

## Monoblock - Series O \$90.00

Upgraded ceramic monoblock brackets. Concentrated for better shaping. Smooth surface, polished and treated. Slot base design to monoblock for a better bonding and de-bonding. Smooth round surface for enhanced patient comfort. Better translucency.

Poly-crystalline ,  
ceramic aesthetic,  
and  
CIM technology

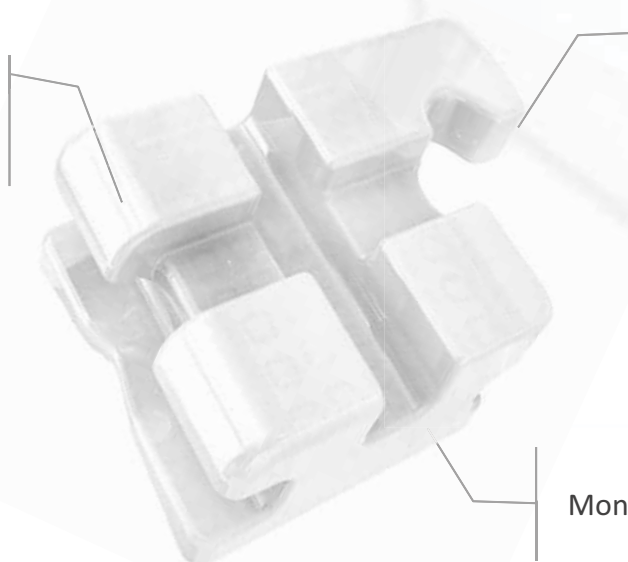

Excellent translucent  
appearance

Monoblock Base for better bonding.

### ■ Roth System

#### ✓ Maxillary

Torque	-7°	-7°	-2°	+8°	+12°	+12°	+8°	-2°	-7°	-7°
Tip	0°	0°	10°	9°	5°	5°	9°	10°	0°	0°
In/out mm	1.2	1.2	1.2	1.7	1.2	1.2	1.7	1.2	1.2	1.2
Width mm	3.2	3.2	3.2	3.0	3.6	3.6	3.0	3.2	3.2	3.2

#### ✓ Mandibular

Torque	-22°	-17°	-11°	-1°	-1°	-1°	-1°	-11°	-17°	-22°
Tip	0°	0°	7°	0°	0°	0°	0°	7°	0°	0°
In/out mm	1.2	1.2	1.2	1.7	1.7	1.7	1.7	1.2	1.2	1.2
Width mm	3.2	3.2	3.2	2.6	2.6	2.6	2.6	3.2	3.2	3.2

### ■ MBT System

#### ✓ Maxillary

Torque	-7°	-7°	-7°	+10°	+17°	+17°	+10°	-7°	-7°	-7°
Tip	0°	0°	8°	8°	4°	4°	8°	8°	0°	0°
In/out mm	1.1	1.1	1.1	1.4	1.2	1.2	1.4	1.1	1.1	1.1
Width mm	3.4	3.4	3.4	3.8	3.8	3.8	3.8	3.4	3.4	3.4

#### ✓ Mandibular

Torque	-17°	-12°	-6°	-6°	-6°	-6°	-6°	-6°	-12°	-17°
Tip	2°	2°	3°	0°	0°	0°	0°	3°	2°	2°
In/out mm	1.1	1.1	1.1	1.3	1.3	1.3	1.3	1.1	1.1	1.1
Width mm	3.4	3.4	3.4	3.0	3.0	3.0	3.0	3.4	3.4	3.4

Slot	Assortments pack	Quantity	3.4.5 with hook
0.022"	1kit	20pcs	accept
0.018"	1kit	20pcs	accept

# Ceramic Brackets

## Mesh Base - Series M \$95.00

Upgraded ceramic monoblock brackets. Concentrated for better shaping. Smooth surface, polished and treated. Slot base design to monoblock for a better bonding and de-bonding. Smooth round surface for enhanced patient comfort. Better translucency.

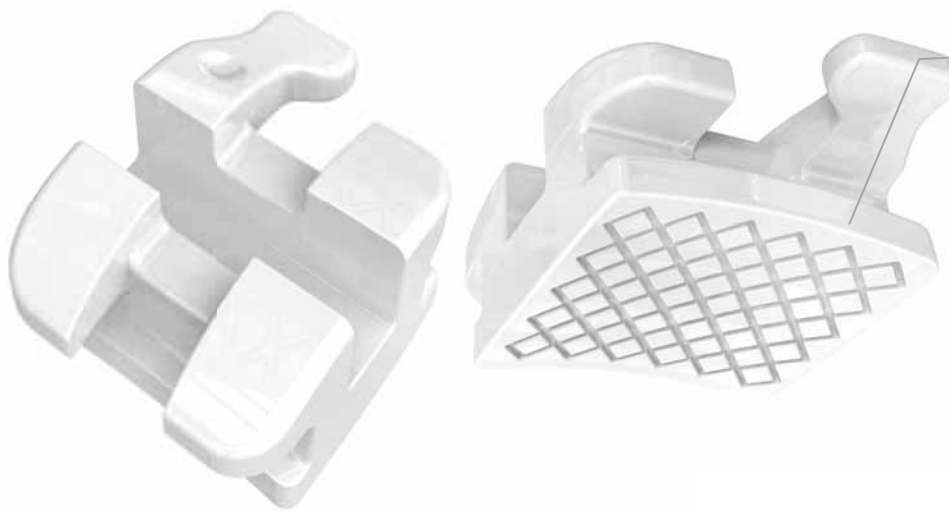

Mesh Base design for better bonding. Excellent translucent appearance. Diamond polishing tech, Ensures a smooth surface. CIM Technology

### ■ Roth System

#### ✓ Maxillary

Torque	-7°	-7°	-2°	+8°	+12°	+12°	+8°	-2°	-7°	-7°
Tip	0°	0°	8°	9°	5°	5°	9°	8°	0°	0°
In/out mm	0.7	0.7	0.7	1.1	0.7	0.7	1.1	0.7	0.7	0.7
Width mm	3.6	3.6	3.4	3.3	3.7	3.7	3.3	3.4	3.6	3.6

#### ✓ Mandibular

Torque	-22°	-17°	-11°	-1°	-1°	-1°	-1°	-11°	-17°	-22°
Tip	0°	0°	7°	0°	0°	0°	0°	7°	0°	0°
In/out mm	0.7	0.7	0.7	1.1	1.1	1.1	1.1	0.7	0.7	0.7
Width mm	3.6	3.6	3.4	3.0	3.0	3.0	3.0	3.4	3.6	3.6

0.022"

1kit

20pcs

accept

# Ceramic Brackets

## Self - Ligating (Active) - Series T \$219.00

Self ligating ceramic brackets made of poly-crystalline. CIM technology,  
Newest aesthetic design for ceramic brackets, with smart self –ligating clip.  
Contoured appearance for maximum comfort.

The optimum base  
which is superior  
at bonding / de-  
bonding



Round ball contact design  
makes lower friction.  
International patent PCT Applied.



Tooth colored slips coated with  
Rhodium

### ■ Roth System

✓ Maxillary

Torque	-7°	-7°	-2°	+8°	+12°	+12°	+8°	-2°	-7°	-7°
Tip	0°	0°	11°	9°	5°	5°	9°	11°	0°	0°
Width mm	3.2	3.2	3.5	3.0	3.5	3.5	3.0	3.5	3.2	3.2

✓ Mandibular

Torque	-22°	-17°	-11°	-1°	-1°	-1°	-1°	-11°	-17°	-22°
Tip	0°	0°	7°	0°	0°	0°	0°	7°	0°	0°
Width mm	3.2	3.2	3.5	2.5	2.5	2.5	2.5	3.5	3.2	3.2

### ■ MBT System

✓ Maxillary

Torque	-7°	-7°	-7°	+10°	+17°	+17°	+10°	-7°	-7°	-7°
Tip	0°	0°	8°	8°	4°	4°	8°	8°	0°	0°
Width mm	3.2	3.2	3.5	3.0	3.5	3.5	3.0	3.5	3.2	3.2

✓ Mandibular

Torque	-17°	-12°	-6°	-6°	-6°	-6°	-6°	-6°	-12°	-17°
Tip	2°	2°	3°	0°	0°	0°	0°	3°	2°	2°
Width mm	3.2	3.2	3.5	2.5	2.5	2.5	2.5	3.5	3.2	3.2

Slot	Assortments pack	Quantity	3.4.5 with hook
0.022"	1kit	20pcs	accept

# Ceramic Brackets

## Self - Ligating (Passive) - Series P \$185.00

Self ligating ceramic brackets made of poly-crystalline, CIM technology.  
Newest aesthetic design ceramic brackets, with smart self –ligating clip.  
Contoured appearance for maximum comfort.

### Power Chain

Enough space is provided  
handle elastics such as power  
chains



Clear self lock and surface

### Clear Aligner

Possible to use  
Clear Aligner during  
Orthodontic treatment



### ■ Roth System

#### ✓ Maxillary

Torque	-7°	-7°	-2°	+8°	+12°	+12°	+8°	-2°	-7°	-7°
Tip	0°	0°	11°	9°	5°	5°	9°	11°	0°	0°
Width mm	3.2	3.2	3.2	3.0	3.6	3.6	3.0	3.2	3.2	3.2

#### ✓ Mandibular

Torque	-22°	-17°	-11°	-1°	-1°	-1°	-1°	-11°	-17°	-22°
Tip	0°	0°	7°	0°	0°	0°	0°	7°	0°	0°
Width mm	3.2	3.2	3.2	2.6	2.6	2.6	2.6	3.2	3.2	3.2

Slot	Assortments pack	Quantity	3.4.5 with hook
0.022"	1kit	20pcs	accept

# Sapphire Brackets

## Self - Ligating - Series K \$499.00

Sapphire self ligating brackets made of mono-crystalline, CIM technology.  
 Newest aesthetic design sapphire brackets, with smart self –ligating clip.  
 Contoured appearance for maximum comfort.

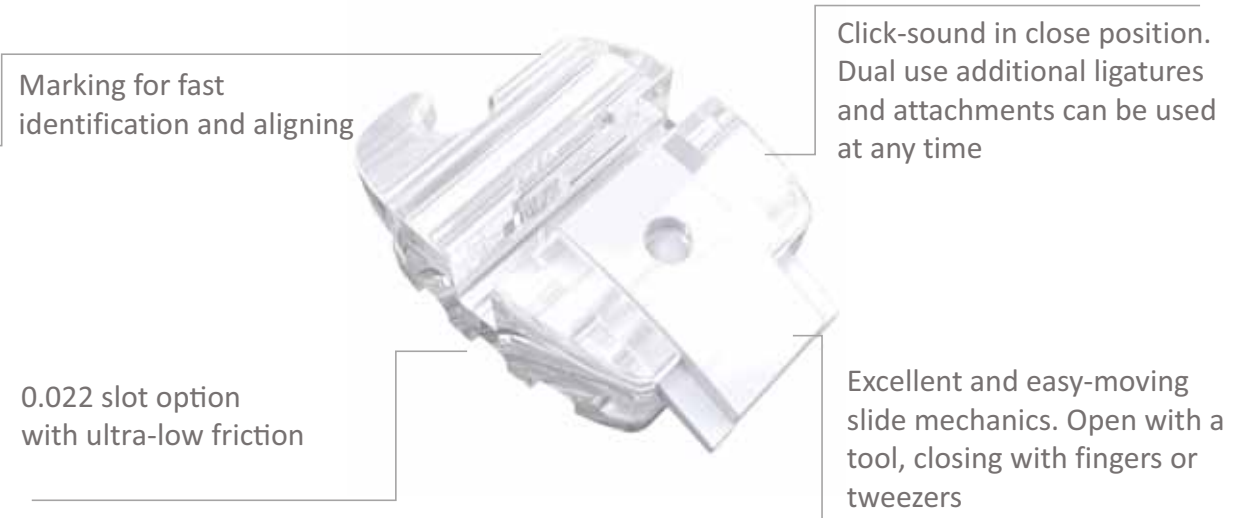

### ■ Roth System

#### ✓ Maxillary

Torque	-7°	-7°	-2°	+8°	+12°	+12°	+8°	-2°	-7°	-7°
Tip	0°	0°	11°	9°	5°	5°	9°	11°	0°	0°
In/out mm	0.75	0.75	0.75	0.75	0.75	0.75	0.75	0.75	0.75	0.75
Width mm	2.8	2.8	2.6	2.4	2.4	2.4	2.4	2.6	2.8	2.8

#### ✓ Mandibular

Torque	-22°	-17°	-11°	-1°	-1°	-1°	-1°	-11°	-17°	-22°
Tip	0°	0°	7°	0°	0°	0°	0°	7°	0°	0°
In/out mm	0.75	0.75	0.75	0.75	0.75	0.75	0.75	0.75	0.75	0.75
Width mm	2.8	2.8	2.8	2.5	2.5	2.5	2.5	2.8	2.8	2.8

### ■ MBT System

#### ✓ Maxillary

Torque	-7°	-7°	-7°	+10°	+17°	+17°	+10°	-7°	-7°	-7°
Tip	0°	0°	8°	8°	5°	5°	8°	8°	0°	0°
In/out mm	0.75	0.75	0.75	0.75	0.75	0.75	0.75	0.75	0.75	0.75
Width mm	2.8	2.8	2.6	2.4	2.4	2.4	2.4	2.6	2.8	2.8

#### ✓ Mandibular

Torque	-17°	-12°	-6°	-6°	-6°	-6°	-6°	-6°	-12°	-17°
Tip	2°	2°	3°	0°	0°	0°	0°	3°	2°	2°
In/out mm	0.75	0.75	0.75	0.75	0.75	0.75	0.75	0.75	0.75	0.75
Width mm	2.8	2.8	2.8	2.5	2.5	2.5	2.5	2.8	2.8	2.8

Slot	Assortments pack	Quantity	3.4.5 with hook
0.022"	1kit	20pcs	accept

# Buccal Tubes

## Self-Ligating

- High precision
- Smooth rounded surface ensure patient comfort
- Accurate passive slip design with number mark on surface
- Reduces the friction between the tube and archwire, makes orthodontic treatment much more accurate and efficient
- All-inclusive design, defined buccal tube indent for accurate stability and placement
- Easy switch between non-convertible and convertible
- 80 gauge mesh base to maximize bond adhesion

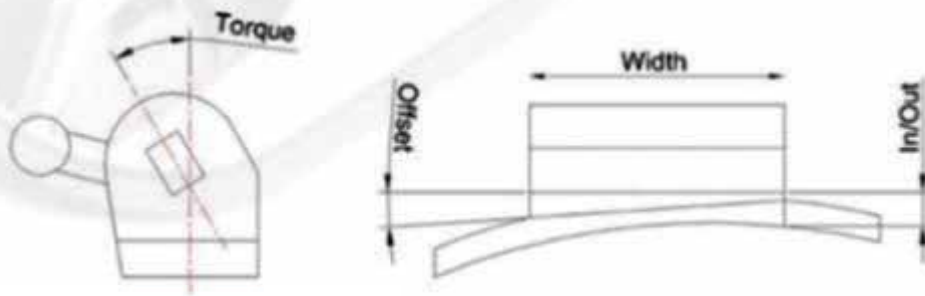

➤ FDI System



1<sup>st</sup> Molar Buccal Tube ☐ \$15.00

Slot :  
22x28/0.56x0.71mm

System	Teeth	Torque	Offset
Roth	16/26	-14°	10°
	36/46	-25°	4°
MBT	16/26	-14°	10°
	36/46	-20°	0°

# Buccal Tubes

## Mesh Base - Type I

- ✓ Applied fine material and molds, made from precise casting process line with compact design.
- ✓ Mesial chamfered entrance for easy guiding of the archwire.
- ✓ Easy Operation. High Bonding strength, contoured mesh base in accordance with the molar crown and curved base design, fully fitted to the tooth. Occlusal indent for precise positioning.
- ✓ Slightly brazed slot cap for the convertible tubes.

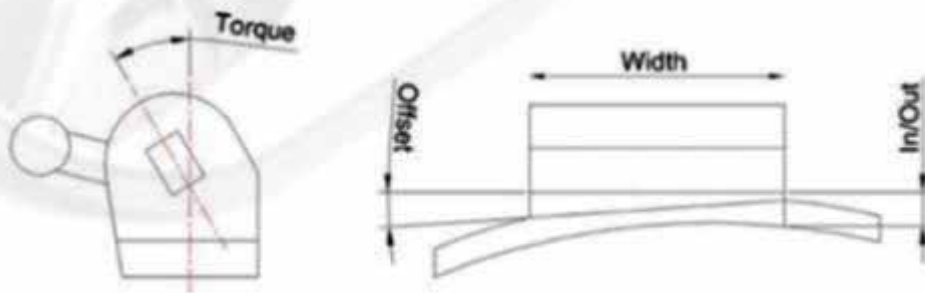

Malleable comfort ball hook

Enhances patient comfort and avoid gingival impingement

Full funneled entrance

Helps guide wire into buccal tube

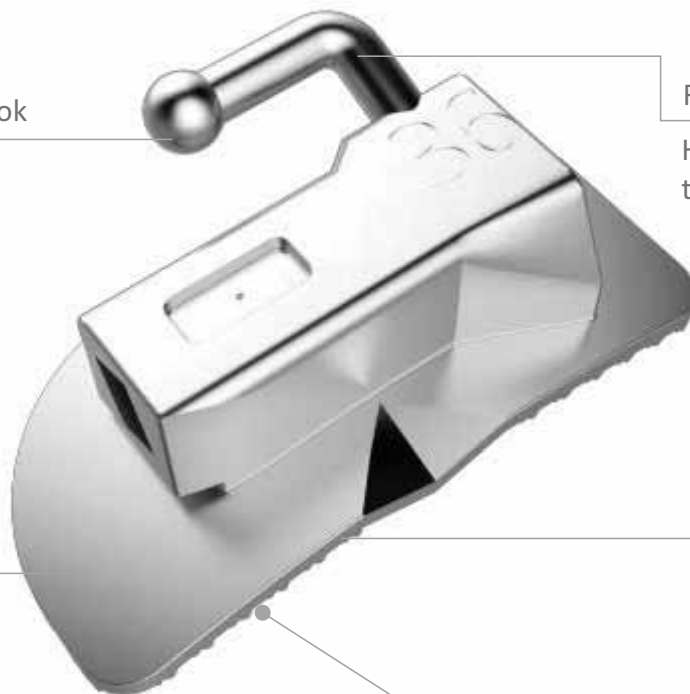

Number mark on surface

80 Gauge mesh base

High quality bold mesh improves stronger bonding by 15%





➤ FDI System



1<sup>st</sup> Molar Buccal Tube ☐ \$10.00 Per Pack of 4

Slot : 18x25/0.46x0.64mm  
22x28/0.56x0.71mm

System	Teeth	Torque	Offset	In/out	width
Roth	16/26	-14°	10°	0.5mm	4.0mm
	36/46	-25°	4°	0.5mm	4.0mm
MBT	16/26	-14°	10°	0.5mm	4.0mm
	36/46	-20°	0°	0.5mm	4.0mm
Edgewise	16/26	0°	0°	0.5mm	4.0mm
	36/46	0°	0°	0.5mm	4.0mm

Code for kits ( 4pcs/kit)

2<sup>nd</sup> Molar Buccal Tube ☐ \$10.00 Per Pack of 4

Slot : 18x25/0.46x0.64mm  
22x28/0.56x0.71mm

System	Teeth	Torque	Offset	In/out	width
Roth	17/27	-14°	10°	0.5mm	3.2mm
	37/47	-25°	4°	0.5mm	3.2mm
MBT	17/27	-14°	10°	0.5mm	3.2mm
	37/47	-10°	0°	0.5mm	3.2mm
Edgewise	17/27	0°	0°	0.5mm	3.2mm
	37/47	0°	0°	0.5mm	3.2mm

Code for kits ( 4pcs/kit)

# Buccal Tubes

## Mesh Base - Type II \$10.00 Per Pack of 4

- ✓ Fine material and molds, made from precise casting process line with compact design.
- ✓ Mesial chamfered entrance for easy guiding of the archwire.
- ✓ Easy Operation. High Bonding strength, contoured mesh base in accordance with the molar crown curved base design, fully fitted to the tooth. Occlusal indent for precise positioning.
- ✓ Slightly brazed slot cap for the convertible tubes.

Compact design,  
perfect shape

High strength  
MIM straight hook

Number graved,  
easy identifying

Mesial chamfered  
entrance for easy  
guiding of arch wire

Wide notch, unique design

Easy for holding the buccal  
tube

Curved Pad, well  
fit to the tooth

Occlusal indent for  
precise positioning



Front



Flank



Understand



➤ FDI System



## 1<sup>st</sup> Molar Buccal Tube

Slot : 18x25/0.46x0.64mm  
22x28/0.56x0.71mm

System	Teeth	Torque	Offset	In/out	width
Roth	16/26	-14°	10°	0.5mm	4.0mm
	36/46	-25°	4°	0.5mm	4.0mm
MBT	16/26	-14°	10°	0.5mm	4.0mm
	36/46	-20°	0°	0.5mm	4.0mm
Edgewise	16/26	0°	0°	0.5mm	4.0mm
	36/46	0°	0°	0.5mm	4.0mm

Code for kits ( 4pcs/kit)

## 2<sup>nd</sup> Molar Buccal Tube

Slot : 18x25/0.46x0.64mm  
22x28/0.56x0.71mm

System	Teeth	Torque	Offset	In/out	width
Roth	17/27	-14°	10°	0.5mm	3.2mm
	37/47	-25°	4°	0.5mm	3.2mm
MBT	17/27	-14°	10°	0.5mm	3.2mm
	37/47	-10°	0°	0.5mm	3.2mm
Edgewise	17/27	0°	0°	0.5mm	3.2mm
	37/47	0°	0°	0.5mm	3.2mm

Code for kits ( 4pcs/kit)

# Buccal Tubes

## Convertible \$10.00 Per Pack of 4

- ✓ Applying fine material and molds, made from precise casting process line with compact design.
- ✓ Mesial chamfered entrance for easy guiding of the arch wire.
- ✓ Easy Operation. High Bonding strength, contoured mesh base in accordance with the molar crown curved, base design, fully fitted to the tooth. Occlusal indent for precise positioning.
- ✓ Slightly brazed slot cap for the convertible tubes.

Color Mark

Laser Number Mark On The Base

Convertible Cap



## 1<sup>st</sup> Molar Buccal Tube

➤ **Single Tube - Convertible** 

Slot : 18x25/0.46x0.64mm  
22x28/0.56x0.71mm

System	Teeth	Torque	Offset	In/out	width
Roth	16/26	-14°	10°	0.4mm	4.0mm
	36/46	-25°	4°	0.4mm	4.0mm
MBT	16/26	-14°	10°	0.4mm	4.0mm
	36/46	-20°	0°	0.4mm	4.0mm
Edgewise	16/26	0°	0°	0.4mm	4.0mm
	36/46	0°	0°	0.4mm	4.0mm

Code for kits ( 4pcs/kit)

# 1<sup>st</sup> Molar Buccal Tube

## ➤ Double Tube - Non-convertible



System	Teeth	Torque	Offset	In/out	width
Roth	16/26	-14°	10°	0.4mm	4.0mm
	36/46	-25°	4°	0.4mm	4.0mm
MBT	16/26	-14°	10°	0.4mm	4.0mm
	36/46	-20°	0°	0.4mm	4.0mm
Edgewise	16/26	0°	6°	0.4mm	4.0mm
	36/46	0°	0°	0.4mm	4.0mm

## ➤ Double Tube - Convertible



System	Teeth	Torque	Offset	In/out	width
Roth	16/26	-14°	10°	0.4mm	4.0mm
	36/46	-25°	4°	0.4mm	4.0mm
MBT	16/26	-14°	10°	0.4mm	4.0mm
	36/46	-20°	0°	0.4mm	4.0mm
Edgewise	16/26	0°	6°	0.4mm	4.0mm
	36/46	0°	0°	0.4mm	4.0mm

## ➤ Triple Tube - Convertible

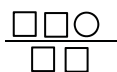

System	Teeth	Torque	Offset	In/out	width
Roth	16/26	-14°	10°	0.4mm	4.0mm
	36/46	-25°	4°	0.4mm	4.0mm
MBT	16/26	-14°	10°	0.4mm	4.0mm
	36/46	-20°	0°	0.4mm	4.0mm
Edgewise	26/26	0°	6°	0.4mm	4.0mm
	36/46	0°	0°	0.4mm	4.0mm

# Molar Bands

## Bands Features

- ✓ Molar bands anatomically conform to the individual tooth.
- ✓ Lingual indent helps for a precise fit and reduce occlusal interference.
- ✓ Available as proportionally half size for each quadrant.
- ✓ Quadrant and sizes are permanently laser marked to the bands.
- ✓ Shaped and contoured anatomically by CAD design. For precise and snap fit.
- ✓ Patented rough inner surface enhance 30% bonding strength.

Ideally hardness for convenient clinical operation

Anatomically contoured for easy placement



Smooth surface and rolled edge for maximum patient comfort

Permanent laser mark is easy for identification

Round interior surface

Ensure maximum bonding strength

### Maxillary

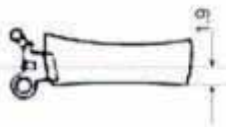

Occlusal Gingiva Positioning  
Center of edgewise slot nearest occlusal is 0.075in ( 1.9mm)

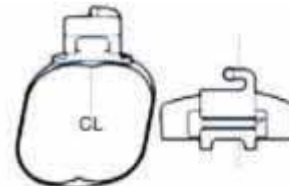

Centerline of buccal tube positioned on buccal indent Form occlusal edge of band. Round tube mounted to occlusal

### Mandibular

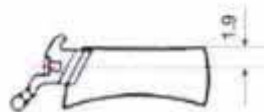

Occlusal gingiva positioning  
Center of edgewise slot nearest occlusal is 0.075in ( 1.9mm)  
Form located edge of band . Hooks are located in mesial-gingival coordinate

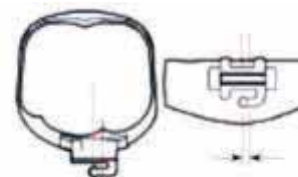

Mesial Distal Positioning  
Centerline of buccal tube Positioned 0.040 in. ( 1.0mm) distal from mesial buccal indent)

## ➤ Pre-welded Bands

For Variety of  
Clinical application

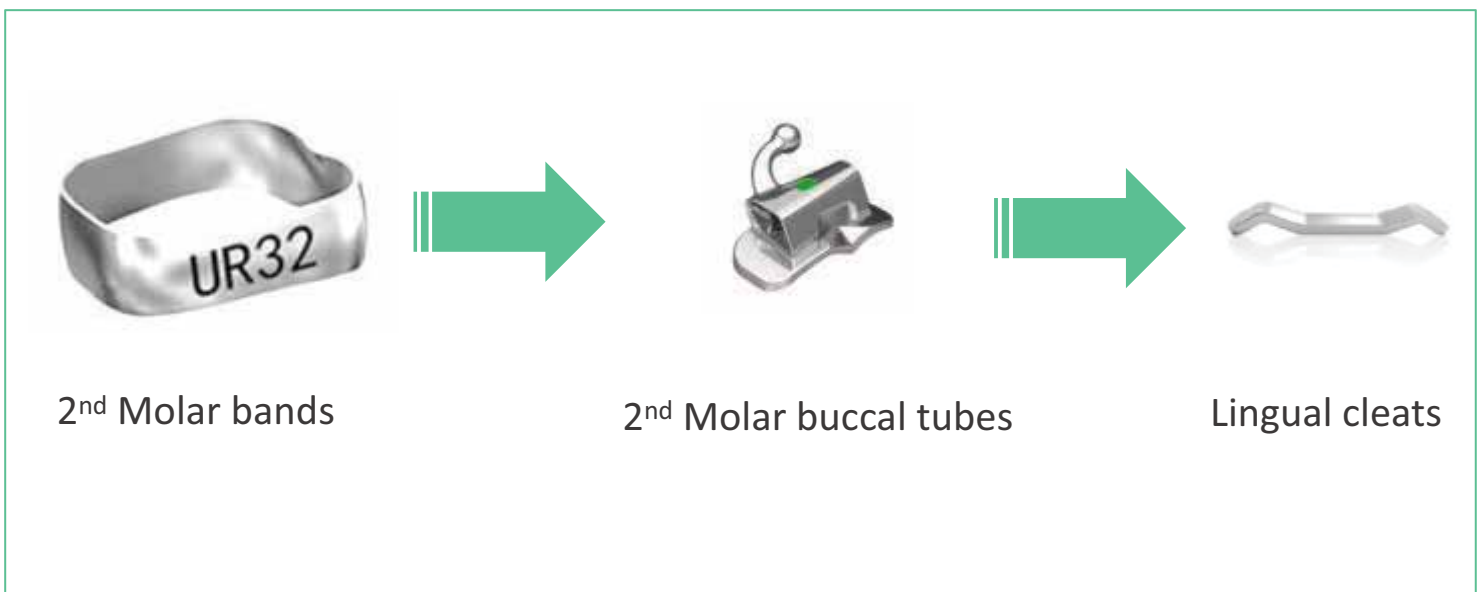
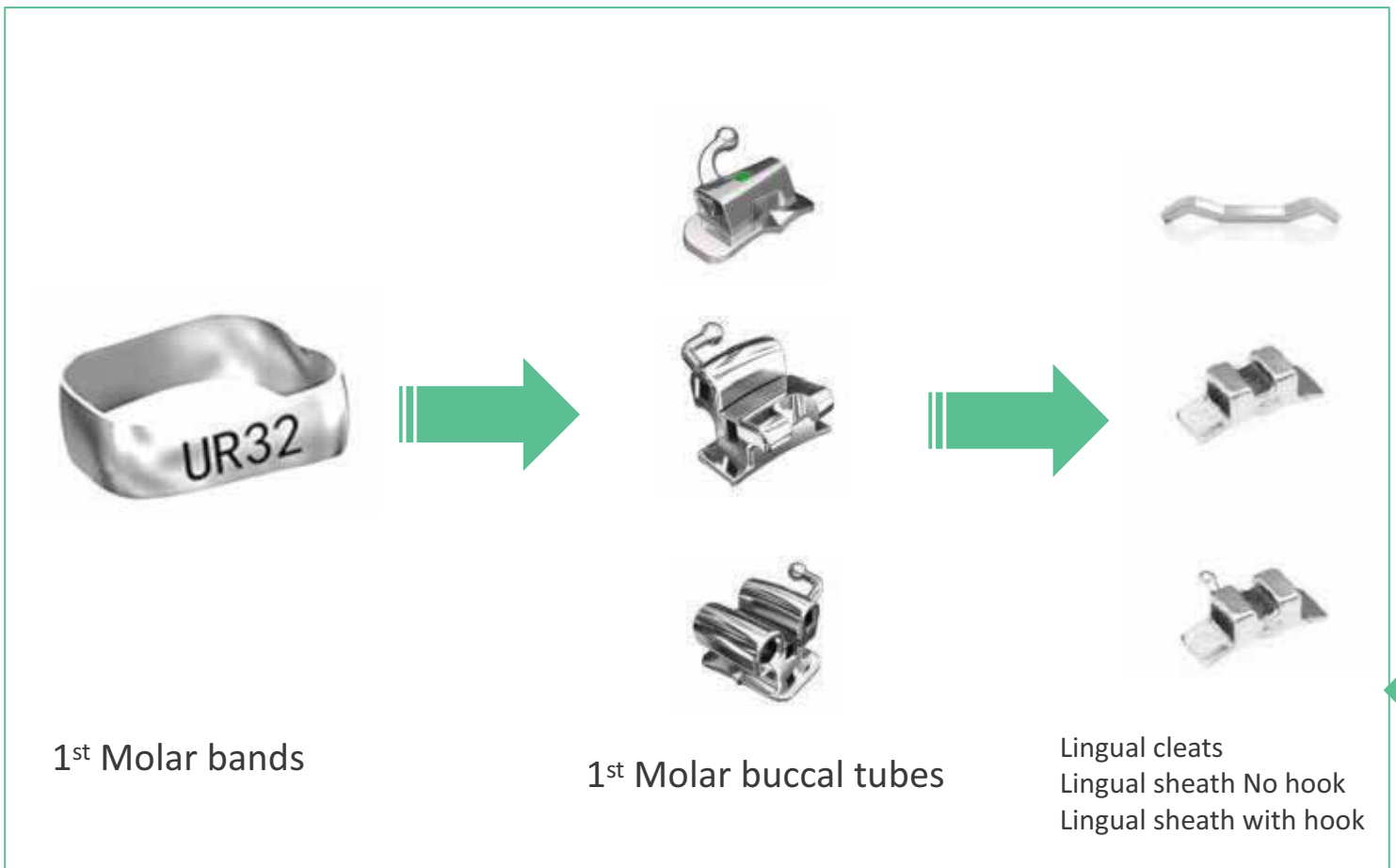

# Molar Bands

\$10.00

With weldable buccal tubes individual pack / 4 pcs per pack

➤ Single Rectangle / Non-convertible



0.022" / 0.018"

System	Teeth	Torque	Offset	width
Roth	16/26	-14°	10°	4.0mm
	36/46	-25°	4°	4.0mm
	17/27	-14°	10°	3.2mm
	37/47	-25°	4°	3.2mm
MBT	16/26	-14°	10°	4.0mm
	36/46	-20°	0°	4.0mm
	17/27	-14°	10°	3.2mm
	37/47	-10°	0°	3.2mm
Edgewise	16/26	0°	0°	4.0mm
	36/46	0°	0°	4.0mm
	17/27	0°	0°	3.2mm
	37/47	0°	0°	3.2mm

■ 1<sup>st</sup> Molar

■ 2<sup>nd</sup> Molar



➤ Single Rectangle / convertible



0.022" / 0.018"

System	Teeth	Torque	Offset	width
Roth	16/26	-14°	10°	4.0mm
	36/46	-25°	4°	4.0mm
MBT	16/26	-14°	10°	4.0mm
	36/46	-20°	0°	4.0mm
Edgewise	16/26	0°	0°	4.0mm
	36/46	0°	0°	4.0mm

■ 1<sup>st</sup> Molar





➤ Double combination - non-convertible  $\frac{\square \circ}{\square}$  0.022" / 0.018"

System	Teeth	Torque	Offset	width
Roth	16/26	-14°	10°	4.2mm
	36/46	-25°	4°	4.2mm
MBT	16/26	-14°	10°	4.2mm
	36/46	-20°	0°	4.2mm
Edgewise	16/26	0°	6°	4.2mm
	36/46	0°	0°	4.2mm

■ 1<sup>st</sup> Molar



➤ Double combination - Convertible  $\frac{\square \circ}{\square}$  0.022" / 0.018"

System	Teeth	Torque	Offset	width
Roth	16/26	-14°	10°	4.2mm
	36/46	-25°	4°	4.2mm
MBT	16/26	-14°	10°	4.2mm
	36/46	-20°	0°	4.2mm
Edgewise	16/26	0°	6°	4.2mm
	36/46	0°	0°	4.2mm

■ 1<sup>st</sup> Molar



➤ Triple combination - Convertible  $\frac{\square \square \circ}{\square \square}$  0.022" / 0.018"

System	Teeth	Torque	Offset	width
Roth	16/26	-14°	10°	4.2mm
	36/46	-25°	4°	4.2mm
MBT	16/26	-14°	10°	4.2mm
	36/46	-20°	0°	4.2mm
Edgewise	16/26	0°	6°	4.2mm
	36/46	0°	0°	4.2mm

■ 1<sup>st</sup> Molar



# Bands Conversation Chart

## ➤ 1<sup>st</sup> molar bands conversion chart

3M mark Rough inner surface	Per-meter mm
28	28
28+	28.5
29	29
29+	29.5
30	30
30+	30.5
31	31
31+	31.5
32	32
32+	32.5
33	33
33+	33.5
34	34
34+	34.5
35	35
35+	35.5
36	36
36+	36.5
37	37
37+	37.5
38	38
38+	38.5
39	39
39+	39.5
40	40
40+	40.5
41	41
41+	41.5
42	42
42+	42.5
43	43
43+	43.5
44	44
44+	44.5

# Bicuspid Bands \$4.00

Bands for **premolar 4 and 5**, plain bicuspid bands **weld bands available**.



## TEETH

15/14

25/24

35/34

45/44

### ➤ Bicuspid molar bands conversion chart

Local Market Mark	Per-meter mm	Local Market Mark	Per-meter mm
1	20.7	17	25.5
2	21	18	25.8
3	21.3	19	26.1
4	21.6	20	26.4
5	21.9	21	26.7
6	22.2	22	27
7	22.5	23	27.3
8	22.8	24	27.6
9	23.1	25	27.9
10	23.4	26	28.2
11	23.7	27	28.5
12	24	28	28.8
13	24.3	29	29.1
14	24.6	30	29.4
15	24.9	31	29.7
16	25.2	32	30

# Archwires

## Feature

- ✓ Excellent Finish, Light and continuous forces
- ✓ More comfortable for the patient, Excellent elasticity
- ✓ Package in surgical grade paper, Suitable for sterilization
- ✓ Suitable for upper and lower arch

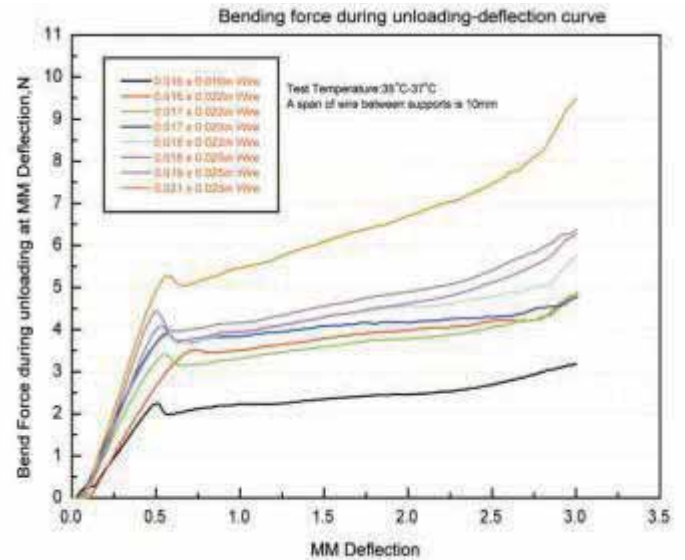
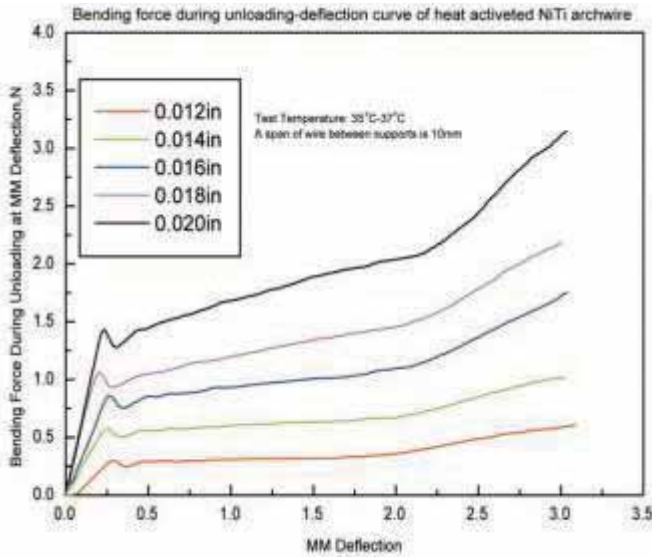

NiTi: super elastic and thermal activated. Generate light and continual force

TMA:  $\beta$ -Ti, nickel free, high elasticity and good bendability with pliers

Stainless Steel: high tensile strength, allows claps, even difficult one's can be easily shaped. Does not break



Square Form



Ovoid Form



Natural Form



Reverse Curve

Arch form: square, ovoid, natural, reverse curve

Round : 0.012" 0.014" 0.016" 0.018" 0.020"

Rectangle : 0.016x0.016" 0.016x0.022" 0.016x0.025"  
 0.017x0.022" 0.017x0.025"  
 0.018x0.018" 0.018x0.022" 0.018x0.025"  
 0.019x0.025" 0.021x0.025"

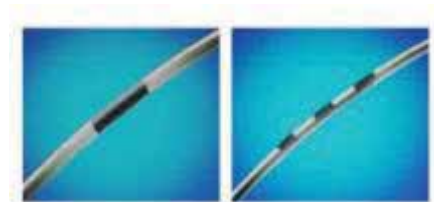

Etched Marked

➤ Super-elastic NiTi Archwire ■ Ovoid ■ Natural ■ Square \$7.00

Products name	Specification	Type	Packing
Super elastic	Round : 0.012"/0.014"/0.016"/0.018"/ 0.020"	Upper	10pcs/pack
Super elastic		Lower	10pcs/pack
Super elastic	Rectangle 0.016x0.016/0.016x0.022 0.017x0.022/0.017x0.025/ 0.018x0.022/0.018x0.025 0.019x0.025/0.021x0.025	Upper	10pcs/pack
Super elastic		Lower	10pcs/pack



➤ Thermal Active NiTi Archwire ■ Ovoid ■ Natural ■ Square \$12.00

Products name	Specification	Type	Packing
Thermal active	Round : 0.012"/0.014"/0.016"/0.018"/ 0.020"	Upper	10pcs/pack
Thermal active		Lower	10pcs/pack
Thermal active	Rectangle 0.016x0.016/0.016x0.022 0.017x0.022/0.017x0.025 0.018x0.022/0.018x0.025 0.019x0.025/0.021x0.025	Upper	10pcs/pack
Thermal active		Lower	10pcs/pack



➤ Stainless Steel Archwire ■ Ovoid ■ Natural ■ Square \$7.00

Products name	Specification	Type	Packing
Stainless steel	Round : 0.012"/0.014"/0.016"/0.018"/ 0.020"	Upper	10pcs/pack
Stainless steel		Lower	10pcs/pack
Stainless steel	Rectangle 0.016x0.016/0.016x0.022 0.017x0.022/0.017x0.025 0.018x0.022/0.018x0.025 0.019x0.025/0.021x0.025	Upper	10pcs/pack
Stainless steel		Lower	10pcs/pack



# Archwires

## ➤ Reverse Curve Niti Archwire \$11.00

Products name	Specification	Type	Packing
Reverse curve	Round : 0.012"/0.014"/0.016"/0.018"/ 0.020"	Upper	2pcs/pack
Reverse curve		Lower	2pcs/pack
Reverse curve	Rectangle 0.016x0.016/0.016x0.022 0.017x0.022/0.017x0.025 0.018x0.022/0.018x0.025 0.019x0.025/0.021x0.025	Upper	2pcs/pack
Reverse curve		Lower	2pcs/pack



## ➤ Reverse Curve Niti Archwire-NEW \$11.00

Products name	Specification	Type	Packing
Reverse curve	Round : 0.012"/0.014"/0.016"/0.018"/ 0.020"	Upper	2pcs/pack
Reverse curve		Lower	2pcs/pack
Reverse curve	Rectangle 0.016x0.016/0.016x0.022 0.017x0.022/0.017x0.025 0.018x0.022/0.018x0.025 0.019x0.025/0.021x0.025	Upper	2pcs/pack
Reverse curve		Lower	2pcs/pack



## ➤ Invisible Niti Archwire Ovoid Natural \$12.00

Products name	Specification	Type	Packing
Invisible	Round : 0.012"/0.014"/0.016"/0.018"/ 0.020"	Upper	1pcs/pack
Invisible		Lower	1pcs/pack
Invisible	Rectangle 0.016x0.016/0.016x0.022 0.017x0.022/0.017x0.025 0.018x0.022/0.018x0.025 0.019x0.025/0.021x0.025	Upper	1pcs/pack
Invisible		Lower	1pcs/pack



➤ **TMA Archwire \$5.00**

■ Ovoid ■ Natural

Products name	Specification	Type	Packing
TMA	Round :	Upper	1pcs/pack
TMA	0.012"/0.014"/0.016"/0.018"/ 0.020"	Lower	1pcs/pack
TMA	Rectangle	Upper	1pcs/pack
TMA	0.016x0.016/0.016x0.022 0.017x0.025/0.018x0.025 0.019x0.025	Lower	1pcs/pack



➤ **Cu-Niti Archwire \$5.00**

Products name	Specification	Type	Packing
Cu-Niti	Round :	With stop tube	1pcs/pack
Cu-Niti	0.013"/0.014"/0.016"/0.018"		
Cu-Niti	Rectangle	With stop tube	1pcs/pack
Cu-Niti	0.014x0.025 0.016x0.022 0.016x0.025 0.017x0.025 0.018x0.025 0.019x0.025		



➤ **Stainless Steel Wire \$15.00**

Products name	Specification	Type	Packing
Stainless Steel Wire	Round :	350mm	10pcs/pack
Stainless Steel Wire	0.012"/0.014"/0.016"/0.018"/ 0.020"		
Stainless Steel Wire	Rectangle	350mm	10pcs/pack
Stainless Steel Wire	0.016x0.016/0.016x0.022 0.017x0.022/0.017x0.025/ 0.018x0.022/0.018x0.025 0.019x0.025/0.021x0.025		



# Archwires

## ➤ Ligature Wire \$11.00

Products name	Specification	Weight
Ligature wire	0.20mm	50g / roll
Ligature wire	0.25mm	
Ligature wire	0.30mm	



## ➤ Preform Ligature Wire / Kobayashi Wire \$15.00

Products name	Specification	Weight
Preform ligature Wire -Short Twist-C	0.008"	100 pcs/pack
	0.010"	
	0.012"	

Products name	Specification	Weight
Kobayashi Wire - Short Twist-F	0.010"	100 pcs/pack
	0.012"	
	0.014"	

Products name	Specification	Weight
Preform ligature Wire -Long-A	0.008"	100 pcs/pack
	0.010"	
	0.012"	

Products name	Specification	Weight
Kobayashi Wire - Long-D	0.010"	100 pcs/pack
	0.012"	
	0.014"	

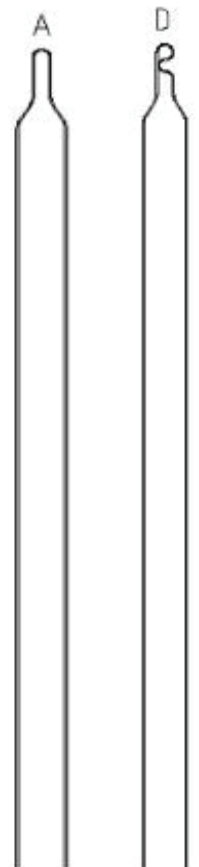
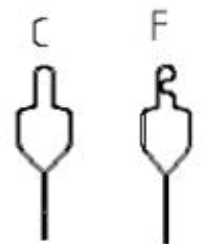



➤ **Niti Close Spring \$12.50**

Type	Wire Diameter	Length (mm)	Packing
Light	0.010"	6mm/9mm/12mm	10pcs/pack
Medium	0.012"	6mm/9mm/12mm	10pcs/pack
Heavy	0.014"	6mm/9mm/12mm	10pcs/pack



➤ **Niti Open Spring \$12.50**

Type	Wire Diameter	Length (mm)	Packing
Light	0.010"	180mm	2pcs/pack
Medium	0.012"	180mm	2pcs/pack
Heavy	0.014"	180mm	2pcs/pack



➤ **Niti Open Spring \$12.50**

Type	Wire Diameter	Length (mm)	Packing
Light	0.010"	914mm	3feet/pack
Medium	0.012"	914mm	3feet/pack
Heavy	0.014"	914mm	3feet/pack



➤ **Stainless Steel Twist Wire \$12.50**

Type	Wire Diameter	Length (mm)	Packing
3 Wires Twist	0.0155"	350mm	10 pcs/pack
3 Wires Twist	0.0175"	350mm	10 pcs/pack
3 Wires Twist	0.0195"	350mm	10 pcs/pack
3 Wires Twist	0.0215"	350mm	10 pcs/pack

Type	Wire Diameter	Length (mm)	Packing
6 Wires Twist	0.0155"	350mm	10 pcs/pack
6 Wires Twist	0.0175"	350mm	10 pcs/pack
6 Wires Twist	0.0195"	350mm </td <td>10 pcs/pack</td>	10 pcs/pack



# Elastics

## Ligature Tie \$11.00

Ligature tie, long tie, S- separator, Rotation Wedge

Ligature ties are injection molded from optimum material, they tend to maintain their elasticity and color over time, do not require to be frequently changed.



- Superior Color Stability, Fade resistant
- High elasticity and excellent rebound
- Medical grade polyurethane
- Latex free safe for sensitive patients
- Gentle and continuous force and good memory



Ligature tie

Pack: 40x26=1040 o-rings / pack

➤ **S - separators \$8.50**

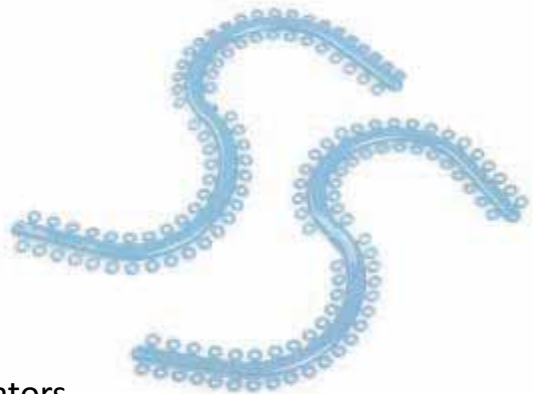

S - separators

Pack: 70x15=1050 o-rings / pack

➤ **Rotation Wedges \$8.50**

Pack: 10 sticks/pack **Clear / Grey**



# Elastic

## Power Chain \$11.00

Long / Short / Closed 4.5m/roll (15feet)

### ➤ Color List For Power Chain

1. Excellent stretch and rebound, giving superior elongation for easy application.
2. High flexibility and resiliency without stiffness, making the chain easier to place and remove while providing a longer lasting tie.



Long



Short

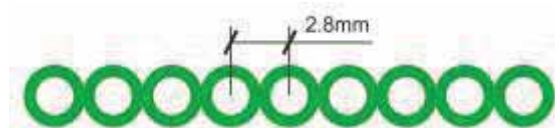





Closed

3. Practice-building colors are color-fast and stain resistant. Offering a consistent force
4. Power chain is latex-free and hypo-allergenic.
5. Medical grade polyurethane ensure.

# Orthodontic Elastic \$30.00 Per Box

5000pcs/pack













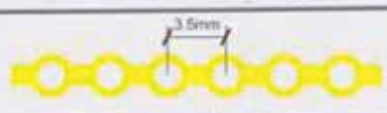











Type	Power	Size				
Light	3.5OZ	1/8" (3.2mm)	3/16" (4.6mm)	1/4" (6.4mm)	5/16" (7.9mm)	3/8" (9.5mm)
Medium	4.5OZ	1/8" (3.2mm)	3/16" (4.6mm)	1/4" (6.4mm)	5/16" (7.9mm)	3/8" (9.5mm)
Heavy	6.5OZ	1/8" (3.2mm)	3/16" (4.6mm)	1/4" (6.4mm)	5/16" (7.9mm)	3/8" (9.5mm)

Size	Pattern	Name
○ 1/8" 3.2mm		Chipmunk
○ 3/16" 4.6mm		Rabbit
○ 1/4" 6.4mm		Fox
○ 5/16" 7.9mm		Penguin
○ 3/8" 9.5mm		Monkey



## COLOR LIST

		Clear	White	Pearly-lustre
				
1	2	3	4	5
				
11	12	13	14	15
				
21	22	23	24	25
				
31	32	33	34	35

		Long		
		Short		
S - separator	Rotation Wedge	Close		
				
6	7	8	9	10
				
16	17	18	19	20
				
26	27	28	29	30
				
36	37	38	39	40



## ACCESSORIES

Lingual button / Crimple hook / Wax / Retainers / Adhesive



# Sapphire

## MULTI Button \$19.00

- Patented base creates a central groove and numerous holes, which maximizes the bonding force
- Created a hole in the patented neck area, where wires 012-018 can be inserted
- Considering the surgeon's convenience we developed and applied an edge head, which makes it easy to catch via pliers during surgeries



- MTM : Minor Tooth Movement



Leveling alignment



Upright

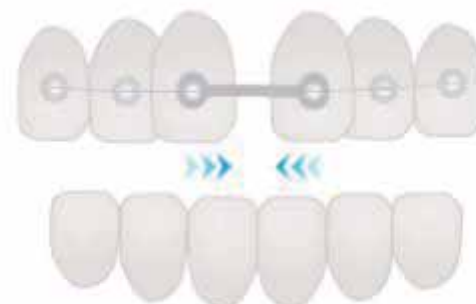

Space closing

Description	Package
Round	10pcs/pack
Rectangle	10pcs/pack



# Accessories

Bondable  
Lingual Button \$15.00  
Round Base  
80 gauge Mesh base



Description	Package
Bondable Lingual Button	10pcs/pack

Bondable  
Lingual Button \$15.00  
Rectangle Base  
80 gauge Mesh base



Description	Package
Bondable Lingual button	10pcs/pack

Bondable  
Eyelet \$15.00  
Round Base  
80 gauge Mesh base



Description	Package
Bondable Lingual Button	10pcs/pack

Bondable  
Lingual Button with cleats  
\$15.00  
Round Base  
80 gauge Mesh base



Description	Package
Bondable Lingual Button	10pcs/pack

Lingual  
Pulling Button \$15.00  
Smooth base  
80 gauge Mesh base



Description	Package
Bondable Lingual Button	10pcs/pack

Bondable  
Hole \$15.00  
Round base  
80 gauge Mesh base



Description	Package
Bondable Lingual Button	10pcs/pack

Button Chain \$10.00

Mesh Base



Description	Package
Button Chain	2pcs/pack
Button Chain - Gold	2pcs/pack

Lingual Button  
Eyelet \$13.50

Rectangle



Description	Package
Bondable Lingual Button	10pcs/pack

Crimpable hook  
\$12.25

Long/Medium/Short



Description	Package
Long L= 3mm	10pcs/pack
Medium L = 2.2mm	10pcs/pack
Short L= 1.3mm	10pcs/pack

Long Curved  
Crimpable Hook  
\$12.00

Right/Left



Description	Package
Right Long L=5.5mm	10pcs/pack
Left Long L=5.5mm	10pcs/pack
Right Medium L=3.5mm	10pcs/pack
Left Medium L=3.5mm	10pcs/pack

Spiral  
Crimpable hook  
\$12.00

Right/Left



Description	Package
Right Hook L=8.7mm	10pcs/pack
Left Hook L=8.7mm	10pcs/pack

Rectangle  
Crimpable Stop  
\$12.00



Description	Package
slot=0.016"	10pcs/pack
slot=0.019"	10pcs/pack
slot=0.022"	10pcs/pack

Cross  
Crimpable hook  
\$12.00



Description	Package
slot=0.018"	10pcs/pack
slot=0.022"	10pcs/pack

Round Tube  
Crimpable Stops  
\$12.00



Description	Package
Φ=0.4mm	10pcs/pack
Φ=0.5mm	10pcs/pack
Φ=0.7mm	10pcs/pack

Bite Opener  
\$12.00

Mesh Base

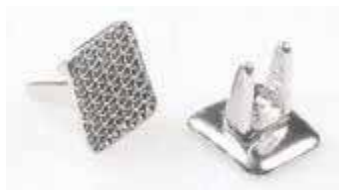

Description	Package
Bite Opener	10pcs/pack

Bite Turbos  
\$12.00

Mesh Base



Description	Package
Bite turbos	10pcs/pack

# Accessories

Activity Crimpable Hook  
with tool  
\$25.00

Common



Description	Package
With Hook - Right	10 pcs/pack
With Hook - Left	10 pcs/pack
No Hook	10 pcs/pack

Rotating Spring  
\$7.50



Description	Package
CW	10 pcs/pack
CCW	10 pcs/pack

Anterior Root Torquing  
Auxiliary Arch  
\$7.50

Large / Medium / Small

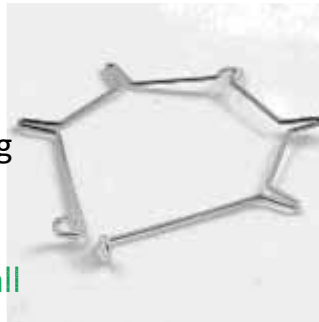

Description	Package
Large	5 pcs/pack
Medium	5 pcs/pack
Small	5 pcs/pack

Torque Spring  
\$7.50

Classic



Description	Package
0.022"	10 pcs/pack

Torque Spring  
\$7.50

Large / Medium / Small



Arch Turrets  
\$32.50

For Round and Rectangle wire



Description	Package
16*22	10pcs/pack
17*25	10pcs/pack
18*25	10pcs/pack
19*25	10pcs/pack

Description	Package
Torque 0° 5 slot Slot size: 0.016",0.017",0.018",0.019", 0.021"	1pcs/pack

Bondable  
Lingual Retainers  
\$4.50  
L=60mm

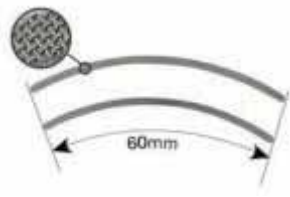

Description	Package
2.0mm	2 pcs/pack
1.5mm	2pcs/pack

Bondable  
Lingual Retainers  
\$4.50  
3-3



Description	Package
Maxillary:32mm/34mm/36mm/ 38mm/ 40mm/ 42mm / 45mm/ 47mm	2 pcs/pack
Mandibular:29mm/31mm/33 mm/35mm/ 37mm	2 pcs/pack

Brackets  
Placement gauge  
\$13.50  
Double Hand



Description	Package
2.0mm,2.5mm,3.0mm,3.5 mm 3.5mm,4.0mm,4.5mm,5.0m m	2 pcs/pack

Brackets  
Placement gauge  
\$20.00  
Cross - for anterior teeth



Description	Package
Cross: 3.5mm;4.0mm;4.5mm;5. 0mm	1 pcs/pack

Expansion  
Screw  
\$25.50  
Common



Description	Package
7mm	1set/pack

Expansion  
Screw  
\$28.50  
Kickstand



Description	Package
#13-10mm	1set/pack



# Accessories

## ➤ Ortho Bonding- Light-cure orthodontic adhesive

Standard box \$36.50

Description	Package
Light-Cure Primer(10ml)	1 Bottle
Light-Cure Paste (3.5g)	3 pieces
Etchant Acid Gel(2.5ml)	1 pieces
Accessories	Brush , Plastic , Stick



Mini box \$35.50

Description	Package
Light-Cure Primer (3ml)	1 Bottle
Light-Cure Paste ( 3.5g)	1 pieces
Etchant Acid Gel (2.5ml)	1 pieces
Accessories	Brush , Plastic , Stick



## ➤ Ortho Force - No-mix orthodontic direct bonding system

Standard box \$36.50

Description	Package
Self-Cure Primer(10ml)	1 Bottle
Self-Cure Paste(3.5g)	3 pieces
Etchant Acid Gel(2.5ml)	1 pieces
Accessories	Brush , Plastic , Stick



Mini box \$35.50

Description	Package
Self-Cure Primer(3ml)	1 Bottle
Self-Cure Paste(3.5g)	1 pieces
Etchant Acid Gel(2.5ml)	1 pieces
Accessories	Brush , Plastic , Stick



## ➤ Blue Glue -Light-cure Band Cement

Standard \$30.00

Description	Package
Light-Cure Cement (5.0g)	1 piece
Etchant Acid Gel (2.5ml)	1 pieces



### Anterior Teeth Turbo

- The occlusal pad, which is bonded to the lingual side of the incisors, is used to open the occlusion of the patient
- Both can be used in deep overlying patients for upper incisors, and also in crossbite. Deep covering for the lower incisors



### Molar Teeth Bite

- Usually bonded in the maxillary molar teeth maxillary first molar central fossa
- To prevent the bonding and mandibular tooth occlusal interference and molar tooth intrusion.

- ✓ Bright Color ,Clear ,Easy to clean
- ✓ Viscosity moderate ,suitable for molding

## ➤ Green Glue -Light-cure Orthodontic Adhesive

Standard \$40.50

Description	Package
Green Glue Primer(3ml)	1 Bottle
Green Glue Paste(3.5g)	2pieces
Etchant Acid Gel(2.5ml)	1 pieces
Accessories	Brush , Plastic , Stick



### ✓ Strong

Quick-cure polymerization provides greater sheer bond strength at initial force loading chemical affinity for metal brackets ensure more reliable bond strength.

### ✓ Flexible

185% more working time than other light cure adhesives all for better placement. Patented formula delivers up to 118% more impact resistance for reduce emergency visits.

### ✓ Smart

On-demand color change for fast and accurate clean up at bonding and depending light cures in as little as 5 seconds for reduced chair time.

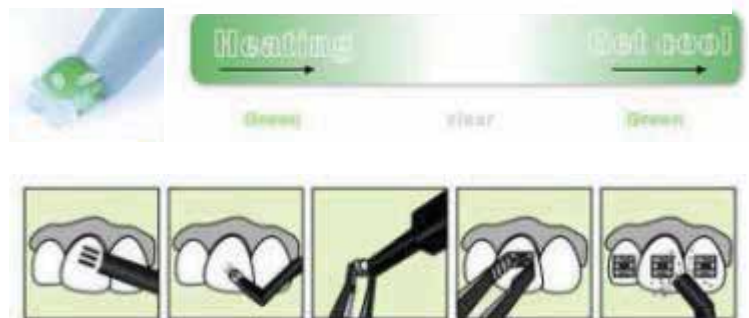

**Green Glue** is the two way color change adhesive for metal brackets and aesthetic bracket that provides the strength.



# TOOL

Dental retractor/ Tweezer/ Face tool/ Dental mirror/Screw



# Micro Implant

## Mini Screw \$8.50 Per Screw

- Made of high surgical grade titanium alloy
- Non-toxicity
- Easy to operate

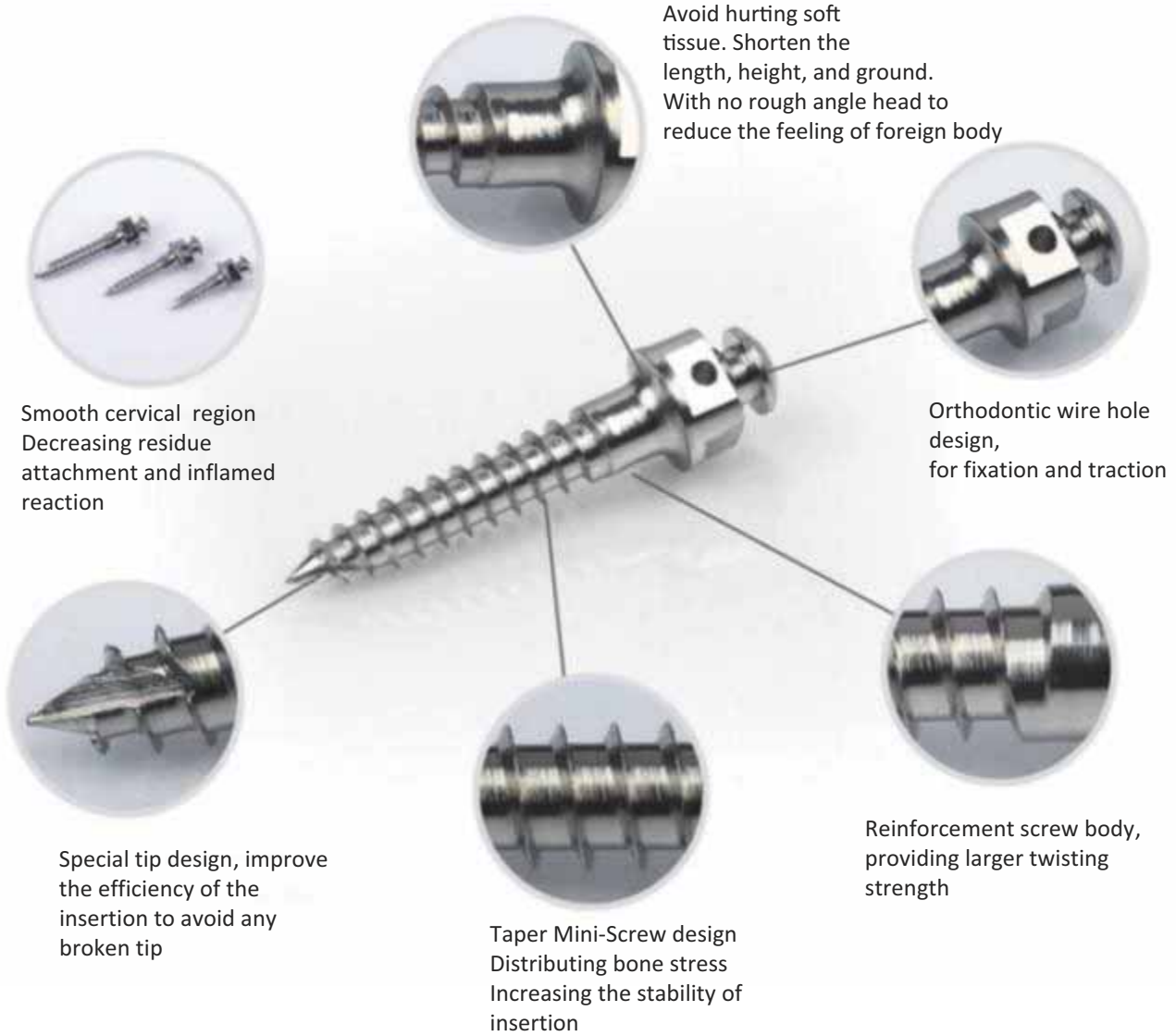

### SIZE

- D1.4x6mm
- D1.4x8mm
- D1.4x10mm

### SIZE

- D1.6x8mm
- D1.6x10mm
- D1.6x12mm

### SIZE

- D2.0x8mm
- D2.0x10mm
- D2.0x12mm

Screw Driver Kit \$300.00

Handle Shack \$44.00



Screw Driver Contra Angle Kit \$340.00



Mini Screw Kit \$350.00



➤ **Orthodontic Tools**



Ligature Gun  
\$9.50

---

1pcs/pack



Dental Dynamometer  
\$20.50  
0-500g (0-16oz)

---

1pcs/pack

Phone: (408) 228-7552

Email: [info@goldenstateortho@gmail.com](mailto:info@goldenstateortho@gmail.com)

Web: [www.gsorthosupply.com](http://www.gsorthosupply.com)

# Orthodontic Tool

## ➤ Face Tool Facemask \$40.00

Maxillary Pull System / Mandibular Pull System



Face Mask  
Single Pole Adjustable



245x85 mm ( 65g )  
1pcs/pack







# ORTHODONTIC CARE

Orthodontic care kit/Ortho wax/Aligner chewies/Aligner removal



# Orthodontic Care

## ➤ Orthodontic Care kit \$6.50 Per Kit

High quality The toothbrush and interdental brush.  
8pcs/pack

### Orthodontic Clean Kit



Minimum Order 200

PVC Plastic BAG



Minimum Order 200

PVC Plastic BOX



Minimum Order 200

Net BAG

# Orthodontic Care

## ➤ Orthodontic Care kit \$6.50 Per Kit

High quality The toothbrush and interdental brush.  
8pcs/pack

## Orthodontic Clean Kit

 color choices







## ➤ Orthodontic Brush

High quality The toothbrush and interdental brush.

### U TYPE



1pcs/bag

- ✓ Medium Brush
- ✓ Du Pont Material



### V TYPE



1pcs/bag

- ✓ Medium Brush
- ✓ Du Pont Material



## Interspace Brush



1pcs/bag



- ✓ Medium Brush
- ✓ Du Pont Material



## Single Tufted Brush



1pcs/bag



- ✓ Soft Brush
- ✓ Du Pont Material



# Contact For Price

## ➤ Tongue Cleaner



## ➤ Denture Brush



---

# PLIERS.

---

TECHNOLOGY  
FOR  
SMILES

---

---

**State of art technology**

High quality pliers without plating,  
perfect performance and quality  
guarantee.

---



Pliers.

Orthodontic Pliers

**ORTHODONTIC PLIERS**

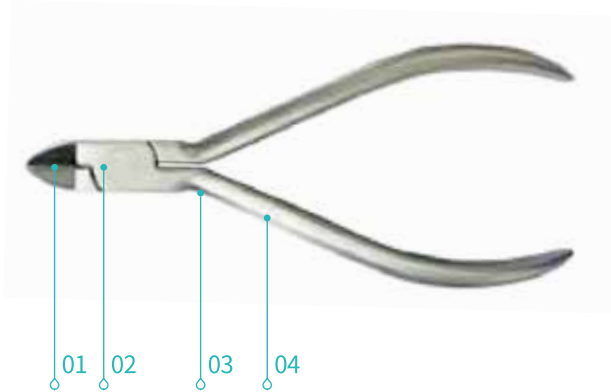

**Pliers Features:**

1. Specially designed zero clearance hinge makes handles more tightly connected, and would not be loosened during operation.
2. Designed in accordance with ergonomics and rounded edges, makes dentists and patients more safety and comfortable.
3. Fine imported medical stainless steels, the pliers has been carefully grounded and polished, perfect in workmanship, excellent corrosion resistant and heat-resistant.
4. Made by CNC production lines with exquisite fixtures and moulds, ensuring precision and high quality.



<b>P106-01</b>	0°	Standard	1pc/pk
<b>P106-01M</b>	0°	Mini	1pc/pk
<b>P106-01L</b>	0°	Long handle	1pc/pk
<b>P106-02</b>	8°	Standard	1pc/pk
<b>P106-03</b>	13°	Standard	1pc/pk
<b>P106-03M</b>	13°	Mini	1pc/pk

\$70.00

**Light wire cutter:**

Hardness : HRC 58-63,  
Cutting edge made by new Technology,  
ligature wires or elastic rings' diameter  
up to 0.30mm (0.012" )  
(can not be used for cutting arch wires)



<b>P106-05</b>	Standard	1pc/pk
<b>P106-05L</b>	Long handle	1pc/pk
<b>P106-05LM</b>	Long handle mini	1pc/pk

\$70.00

**Distal end cutter:**

Hardness : HRC 58-63,  
Cutting edge made by new technology.  
Used to cut the long distal end of arch  
wires, and safety holding the cut part.  
Arch wires up to 0.021" X0.025"  
(0.53mmX0.64mm)  
Mini tip : 0.018" x0.022"



<b>P106-06</b>	Standard	1pc/pk
<b>P106-06L</b>	Long handle	1pc/pk
<b>P106-06LM</b>	Long handle mini	1pc/pk

\$70.00

**Distal end cutter-with  
flush end :**

Hardness : HRC 58-63,  
Cutting edge made by new technology.  
Used to cut the distal end of arch wires  
and safety holding the cut part, the distal  
end of arch wire will be flush with tube  
slot' s distal end. Arch wires up to  
0.021" X0.025" (0.53mmX0.64mm)

## Orthodontic Pliers

### Light wire pliers:

Hardness of tip: HRC 55-60,  
Cutting edge made by new Technology,  
Used to make different fine loops for arch wires,  
and to make spring loops. Wires' diameter up  
to 0.030" (0.76mm)

<b>P106-07</b>	Standard	1pc/pk
<b>\$70.00</b>		



### Light wire pliers with cutter:

Hardness of tip: HRC 55-60 ,  
Cutting edge made by new technology,  
Used to make different fine loops for  
arch wires, and to make spring loops.  
Tip with cutting edge for wires cutting.

<b>P106-08</b>	Standard	1pc/pk
<b>\$70.00</b>		



### Heavy cutter:

Hardness of tip: HRC 58-63,  
Cutting edge made by new technology,  
Used to cut Australia wires, NITI wires,  
stainless steel wires, Wires' diameter up  
to 0.030" (0.76mm)

<b>P106-09</b>	Standard	1pc/pk
<b>\$70.00</b>		



### NITI cinch back pliers:

Hardness of tip: HRC 55-60 ,  
Cutting edge made by new technology.  
Used to cinch back distal end of arch  
wires to avoid any injury of soft tissue.  
NITI wires' diameter up to 0.021" (0.53mm)

<b>P106-10</b>	Dual direction	Standard	1pc/pk
----------------	----------------	----------	--------

**\$70.00**



### V stop pliers:

To make V stop along arch  
wires to prevent any movement.

<b>P107-01</b>	1pc/pk
----------------	--------

**\$70.00**



Orthodontic Pliers



P107-02	Standard	1pc/pk
P302-01	Replacement tips	10pcs/pk

\$70.00

Cap removing pliers:

To remove the caps of convertible tubes.



P105-01	1pc/pk
---------	--------

\$70.00

Torque pliers:

Hardness of tip: HRC55-60 ,  
Cutting edge made by new technology.  
Used in pair to make torques on rectangle wires, thickness of tips: 0.050" (1.27mm)



P105-02	1pc/pk
---------	--------

\$70.00

Tweed loop pliers:

Hardness of tip: HRC55-60 ,  
Cutting edge made by new technology.  
To make small loops, distal stops and  $\Omega$  loops on arch wires



P105-16	Posterior/long tip	1pc/pk
P301-01	Replacement tips	10pcs/pk

\$70.00  
Tips: \$ 13.50

Band remover:

Hardness of tip: HRC 50-55  
Used to remove bands and other bondable attachment.



P105-05	1pc/pk
---------	--------

\$70.00

Bracket removing pliers:

Hardness of tip: HRC 50-55  
Used to remove anterior brackets.



P105-06	Standard	1pc/pk
---------	----------	--------

\$70.00

Posterior bracket removing pliers:

Hardness of tip: HRC 50-55  
Used to remove posterior brackets.



## Orthodontic Pliers

### Weingart pliers:

Hardness of tip: HRC 50-55  
Used to cinch back distal end of arch wires to avoid any injury of soft tissue.

<b>P105-07</b>	Standard	1pc/pk
<b>\$70.00</b>		



### Crimpable hook pliers:

Hardness of tip: HRC 50-55  
To fix the crimpable hooks along arch wires.

<b>P105-08</b>	Standard	1pc/pk
<b>P105-08L</b>	Long handle	1pc/pk
<b>\$70.00</b>		



### Loop bending pliers:

Hardness of tip: HRC 50-55  
To make different small loops for multi-loop edgewise arch wires, diameter of loops: 2.00, 3.20, 4.20 mm.

<b>P105-09</b>	1pc/pk
<b>\$70.00</b>	



### How's pliers:

Hardness of tip: HRC 50-55  
To hold arch wires for guiding it into buccal tubes, to hold ligature wires, or to form anterior band.

<b>P105-10</b>	1pc/pk
<b>\$70.00</b>	



### Kim pliers:

Hardness of tip: HRC 50-55  
To bend multi-loop edgewise wires, with cutter on tips.

<b>P105-11</b>	1pc/pk
<b>\$70.00</b>	



### Nance loop bending pliers:

Hardness of tip: HRC 50-55  
To make vertical loops of different height along arch wires, 3.0, 4.0, 5.0, 6.0mm  
Wires' diameter up to : 0.022" (0.56mm )

<b>P105-12</b>	1pc/pk
<b>\$70.00</b>	



## Orthodontic Pliers



P105-13	Standard	1pc/pk
P301-02	Replacement tips	10pcs/pk
P302-02	Replacement blade	10pcs/pk

\$70.00

### Bondage removing pliers:

Hardness of tip: HRC50-55 ,  
Used to remove bondage on the crown  
without any injury on enamel.



P105-14	1pc/pk
---------	--------

\$65.50

### Three jaw pliers:

Hardness of tip: HRC50-55 ,  
To make V loops and bend arch wires.  
Wires' diameter up to 0.030" (0.76mm)



P105-15	1pc/pk
---------	--------

\$70.00

### Omega loop bending pliers:

Hardness of tip: HRC50-55 ,  
To make fine  $\Omega$  loops. Three different loops:  
diameter 0.063" , 0.075" , 0.10"  
(diameter 1.6mm, 2.0mm, 2.6mm )



P103-01	1pc/pk
---------	--------

\$50.00

### Elastic pliers:

Hardness of tip: HRC50-55 ,  
For expanding elastic separating  
rings before separating molar gap.



P201-04	Standard	1set/pk
---------	----------	---------

\$80.50

### Pliers stands:

Fully stainless steel stands  
Newly designed, high  
temperature sterilized.

**30%**  
**Off Your First Order**



**PRICE  
BEAT  
GUARANTEE**

off your current supplier prices.  
\*Must present current invoice\*.  
FREE Shipping on all orders.

Brackets  
Archwires  
Buccal Tubes  
and much more....

Serving multiple locations  
in Northern California



# FREE OFFER!

Fax or email us your current  
Orthodontic invoice.

We will mail you a free cost comparison  
for your consideration and a

**\$20 Starbucks gift card**

Email us copies of invoices of the  
Orthodontic products you are currently using.  
email: [goldenstateortho@gmail.com](mailto:goldenstateortho@gmail.com)

