

**OPERATION/MAINTENANCE  
AND PARTS MANUAL  
MX80 / 90 / 110  
VIBRATORY PLATE COMPACTORS**



FEBRUARY 2. 2016

**SECTION 1 -  
SAFETY PRECAUTIONS AND GUIDELINES**

---

---

<b>Contents</b> .....	<b>Page</b>
<b>OVERVIEW</b> .....	<b>1</b>
<b>PRE-START INSPECTION</b> .....	<b>1</b>
<b>OPERATING</b> .....	<b>1</b>
<b>MAINTENANCE</b> .....	<b>2</b>
<b>OPERATING PROCEDURES</b> .....	<b>2</b>

**OVERVIEW**

BEFORE YOU OPERATE, MAINTAIN OR IN ANY OTHER WAY, OPERATE THIS MACHINE:

READ and STUDY this manual. KNOW how to safely use the unit's controls and what you must do for safe maintenance.

The machine has been built in accordance with state-of-the-art standards and the recognized safety rules. Nevertheless, its use may constitute a risk to life and limb of the user or of third parties, or cause damage to the machine and to other material property.

ALWAYS wear or use the proper safety items required for your personal protection.

For reasons of security, long hair must be tied back or otherwise secured, garments must be close-fitting and no jewelry – such as rings or watches - may be worn. Injury may result from being caught up in the machinery or from rings catching on moving parts.

If you have ANY QUESTIONS about the safe use or maintenance of this unit, ASK YOUR SUPERVISOR OR CONTACT ANY DISTRIBUTOR. NEVER GUESS - ALWAYS CHECK.

Never make any modifications, additions or conversions which might affect safety without the supplier's approval. This also applies to the installation and adjustment of safety devices and valves as well as to welding work on load-bearing elements.

Observe all fire-warning and fire-fighting procedures.

**PRE-START INSPECTION**

INSPECT your machine. Have any malfunctioning, broken or missing parts corrected or replaced before use.

Check the machine at least once per working shift for obvious damage and defects. Report any changes (incl. changes in the machine's working behavior) to the competent organization/person immediately. If necessary, stop the machine immediately and lock it.

Take the necessary precautions to ensure that the machine is used only when in a safe and reliable state.

Operate the machine only if all protective and safety oriented devices, such as removable safety devices, emergency shut-off equipment, sound-proofing elements and exhausts, are in place and fully functional.

The electrical equipment of machines is to be inspected and checked at regular intervals. Defects such as loose connections or scorched cables must be rectified immediately.

VERIFY that all the instruction and safety labels are in place and readable. These are as important as any other equipment on the compactor. NEVER fill the fuel tank, with the engine running, while near an open flame, or while smoking. ALWAYS wipe up any spilled fuel immediately.

**SECTION 1 -  
SAFETY PRECAUTIONS AND GUIDELINES**

---

---

CHECK for WARNING tags placed on the machine. DO NOT operate the equipment until repairs have been made and the WARNING tags have been removed by authorized personnel.

KNOW the location of the Emergency Shut-Down Control if the machine is so equipped.

**OPERATING**

In the event of safety-relevant modifications or changes in the behavior of the machine during operation, stop the machine immediately and report the malfunction to the competent authority/person.

Always wear the prescribed ear protectors.

Always make sure that no person or obstruction is in your line of travel. Watch your step to avoid tripping.

USE extreme caution and be observant when working in close quarters or congested areas.

Before beginning work, familiarize yourself with the surroundings and circumstances of the site, such as obstacles in the working

and traveling area, the soil bearing capacity and any barriers separating the construction site from public roads.

When traveling on public roads, ways and places always observe the valid traffic regulations and, if necessary, make sure beforehand that the machine is in a condition compatible with these regulations

Always keep at a distance from the edges of building pits and slopes.

DO NOT run the engine in a closed building for an extended length of time. EXHAUST FUMES CAN KILL.

DO NOT operate the compactor on non-compactable material, such as concrete or hardened asphalt.

**MAINTENANCE**

Observe the adjusting, maintenance and inspection activities and intervals set out in the operating instructions, including information on the replacement of parts and equipment. These activities must be executed by skilled personnel only.

Ensure that the maintenance area is adequately secured.

After cleaning, examine all fuel, lubricant, and hydraulic fluid lines for leaks, loose connections, chafe marks and damage. Any defects found must be rectified without delay.

Always tighten any screwed connections that have been loosened during maintenance and repair.

**SECTION 1 -  
SAFETY PRECAUTIONS AND GUIDELINES**

---

---

Any safety devices removed for set-up, maintenance or repair purposes must be refitted and checked immediately upon completion of the maintenance and repair work.

Ensure that all consumables and replaced parts are disposed of safely and with minimum environmental impact.

AVOID, whenever possible, servicing, cleaning or examining the unit with the engine running.

NEVER fill the fuel tank, with the engine running, while near an open flame, or while smoking. ALWAYS wipe up any spilled fuel immediately.

ALWAYS disconnect the spark plug before performing any work on the unit.

DO NOT alter the engine governor settings from those indicated in the engine manual.

ALWAYS replace damaged or lost decals. Refer to the Parts Manual for the proper location and part number of all decals.

Carry out welding, flame-cutting and grinding work on the machine only if this has been expressly authorized, as there may be a risk of explosion and fire.

Before carrying out welding, flame-cutting and grinding operations, clean the machine and its surroundings from dust and other inflammable substances and make sure that the premises are adequately ventilated (risk of explosion).



## **SECTION 2 - INTRODUCTION**

EXCELLENT CHOICE! MEIWA Vibratory Plate Compactor you have chosen will give you many hours of maintenance free operation resulting in a faster return of your investment.

Safe operation depends on reliable equipment and the use of proper operating procedures. Performing the checks and services described in this manual will help keep your machine in good condition. These recommended operation procedures will help you to avoid unsafe practices.

Safety notes have been included throughout this manual to help you avoid injury and prevent damage to the equipment. These notes are not intended to cover all eventualities; it is impossible to anticipate and evaluate all possible methods of operation. Therefore, you are the only person who can guarantee safe operation and maintenance. It is important that any procedure not specifically recommended in this manual be thoroughly evaluated from the standpoint of safety before it is implemented.

Continuing improvement and advancement of product design may cause changes to your machine which may not be included in this publication. Each publication is reviewed and revised, as required, to update and include these changes in later editions. MEIWA reserves the right to modify or make changes within a specific model group without notice and without incurring any liability to retrofit units previously shipped from the factory. Contact your MEIWA Distributor for non-routine maintenance information that is not covered in this publication.

























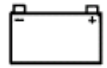

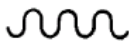

## SECTION 3 - SYMBOL IDENTIFICATION AND METRIC CONVERSION

Contents	Page
INTERNATIONAL MACHINE SYMBOLS _____	1
INTERNATIONAL HIGHWAY SYMBOLS _____	2
METRIC CONVERSIONS _____	4

### INTERNATIONAL MACHINE SYMBOLS

























The following explains the meaning of international symbols that may appear on your machine

	OIL PRESSURE		BRAKE		HOURS
	WATER TEMPERATURE		HORN		NEUTRAL
	ON / OFF		CAUTION		LOW ENGINE RPM.
	LIGHTS		FUEL		BRAKE-PARK
	WATER		SLOW		VIBRATION
	BATTERY		FAST		AMPLITUDE
	AMMETER OR VOLTMETER		TRANSMISSION		FREQUENCY
	AIR PRESSURE		GREASE		CAUTION-PRESSURIZED
	LOW AIR PRESSURE		OIL		
	ENGINE RPM		HYDRAULIC OIL		





















**SECTION 3 - SYMBOL IDENTIFICATION AND METRIC CONVERSION**  
**INTERNATIONAL HIGHWAY SYMBOLS**

The following symbols may also appear in a yellow square instead of a red triangle.

	Road bends		Uneven road
	Dangerous bend		Ridge
	Double bend		Dip
	Dangerous descent		Slippery road
	Steep ascent		Loose gravel
	Carriageway narrows		No entry for power driven vehicles
	Carriageway narrows		No entry for vehicles exceeding length
	"end of priority" sign		No entry for vehicles exceeding length
	Oncoming traffic has priority		Falling rocks
	Priority over oncoming traffic		Pedestrian crossing
	Swing bridge		Road work
	Road leads onto quay or river bank		Light signals

**SECTION 3 - SYMBOL IDENTIFICATION AND METRIC CONVERSION**

	Two-way traffic		"give way" sign
	Other dangers		Stop sign (new)
	Level crossing		Stop sign (old)
	Level crossing		"priority road" sign
	No entry		No entry for vehicles exceeding weight
	Closed to all vehicles in both directions		No entry for vehicles axle weight exceeding
	Intersection, user must give way		No u-turn
	Intersection, user must give way		No turn direction shown
	Intersection, user must give way		No entry for power driven vehicles

### SECTION 3 - SYMBOL IDENTIFICATION AND METRIC CONVERSION

TO CONVERT OMREGNET FRA	INTO TIL	MULTIPLY BY MULTIPLICERES MED
Bar	Pound/sq.in	14.50
Bar	Kilopascals	100.
Centigrade	Fahrenheit	$(C^{\circ} \times 9/5) + 32$
Centimeters	Inches	0.3937
Centimeters	Millimeters	10.0
Circumference	Radians	6.283
Cubic centimeters	cu.inches	0.06102
Degrees (angle)	Radians	0.01745
Degrees/sec.	Revolutions/min	0.1667
Feet	Meters	0.3048
Feet/min	Meters/min.	0.3048
Foot-pounds	Kg-meters	0.1383
Gallons	Liters	3.785
Hertz	Vibrations/min.	60.
Horsepower	Kilowatts	0.7457
Inches	Centimeters	2.540
Inches	Millimeters	25.40
Kilograms	Pounds	.250
Kilogram meters	-Pounds	7.233
Kilopascal	Pounds/sq.in	0.1450
Kilopascal	Bars	0.01
Kilowatts	Horsepower	1.341
Liters	Gallons (U.S. liq)	0.2642
Liters	Pints (U.S. liq)	2.113
Liters	Quarts (U.S. liq)	1.057
Meters	Feet	3.281
Meters	Inches	39.37
Meters/min	Feet/sec	0.05468
Miles/hr	kms/hr	1.609
Millimeters	Inches	0.03937
Newtons	Pounds	4.448
Newton-meter	Pound-feet	0.737
Pounds	Kilograms	0.4536
Pounds	Newtons	0.225
Pound feet	Newton-meter	1.356
Pounds/ft.	kgs/meter	1.488
Pounds/sq in	Bars	0.06895
Pounds/sq in	Kilopascals	6.895
Quarts (liq)	Liters	0.9463
Radians	Degrees	57.30
Radians/sec	Revolutions/min	9.549
Revolutions/min	Degrees/sec	6.0
Revolutions/min	Radians/sec	0.1047
Temperature ( $^{\circ}$ C) + 17.78	Temperature ( $^{\circ}$ F)	1.8
Temperature ( $^{\circ}$ F) - 32	Temperature ( $^{\circ}$ C)	5/9
Tons (short)	Tons (metric)	0.9078
Vibrations/min	Hertz	0.0167

## SECTION 4 - OPERATING INSTRUCTIONS

---

---

Contents	Page
SAFETY CHECKS - PRE-STARTING _____	1
INSPECTION PRIOR TO OPERATION _____	2
OPERATION _____	2
STORAGE _____	6

---

### WARNING

Improper maintenance can be hazardous.

Read and understand SECTION 1 - SAFETY PRECAUTIONS AND GUIDELINES before you perform any maintenance, service or repairs.

#### SAFETY CHECKS - PRE-STARTING

Before starting each day, in addition to the 10 hour daily routine maintenance, check or inspect the following items to ensure trouble free performance.

1. Check fluid lines, hoses, fittings, filler openings, drain plugs, pressure cap, muffler, safety shrouds and the area underneath the unit for signs of leakage or damage. Fix any leaks and correct any damage before operating.
2. Inspect the entire unit for damaged or missing parts and repair or replace parts as needed.
3. Check the fuel level. If necessary, fill the fuel tank with the proper fuel.
4. Check all fastening hardware to ensure it is adequately tightened and that none is missing or broken.
5. Do not operate faulty equipment.
6. Be observant of people and obstructions within the work area.
7. Read "INSTRUCTIONS FOR USE" for HONDA GX120 engine for MX80 and GX160 engine for MX90/110 models and this instruction manual for correct use and care.

Be sure the unit is correctly maintained in good operating condition.

## SECTION 4 - OPERATING INSTRUCTIONS

---

### INSPECTION PRIOR TO OPERATION

#### CHECK ENGINE OIL

Before checking or refilling engine oil, be sure the compactor is located on a stable level surface.

Do not thread the gauge into oil filler to check oil level. If the oil level is below the lower level line on the dipstick, refill with the proper oil to the upper level (to the neck of oil filler). See section 9.

#### CHECK ENGINE FUEL

**⚠ WARNING**

**Do not refuel while smoking, near an open flame or other potential hazards.**

#### CLEANING AIR CLEANER

**⚠ CAUTION**

**Do not run the engine without the air cleaner. Rapid engine wear will result.**

**If the air cleaner element is seriously contaminated, engine start up failure, poor output or engine malfunction may result.**

Check Air Cleaner to be sure it is clean and not contaminated. If cleaning is required, perform the following steps:

Remove the wing nut, air cleaner cover, outer urethane foam element and inner paper element. Wash the foam element in a household cleaner and warm water. Rinse thoroughly and allow to dry completely. Saturate the foam element in engine oil and squeeze out the excess oil. Tap the inner paper element lightly on a hard surface or blow out with compressed air from the inside. Do not use a brush to clean the element. Wipe out the air cleaner cover with a clean damp cloth and reassemble the air cleaner.

#### CHECK EACH PART FOR LOOSE OR BROKEN BOLTS AND NUTS

Tighten loose bolts and nuts, if any. Check each part for fuel or oil leak. Replace broken or damaged parts, if any, with new ones.

## SECTION 4 - OPERATING INSTRUCTIONS

---

### OPERATION

#### STARTING

1. Turn the STOP SWITCH (1, Figure 4-1) clockwise to the position "I" (ON).

Figure 4-1



2. Open the FUEL COCK (1, Figure 4-2) located right side.

Figure 4-2



3. Close the CHOKE LEVER (1, Figure 4-2). If the engine is cold or the ambient temperature is low, close the Choke Lever fully. If the engine is warm or the ambient temperature is high, open the Choke Lever half-way, or keep it fully open.

## SECTION 4 - OPERATING INSTRUCTIONS

---

4. Position THROTTLE LEVER (Figure 4-2) to "LOW" speed position.



Avoid fully pulling out the rope. Return the Handle to its original position.

5. Pull the STARTER HANDLE (1, Figure 4-2) of RECOIL STARTER slowly until resistance is felt. This is the "COMPRESSION" point. Return the Handle to its original position and pull swiftly. After starting the engine, allow the Starter Handle to return to its original position while still holding the Handle.

After the engine starts, set the Throttle Lever (Figure 4-2) at the low speed position "LOW" and warm it up without load for a few minutes. Fully open CHOKE LEVER (1, Figure 4-2) gradually.

### RUNNING

1. Shift the Throttle Lever (Figure 4-2) to "HIGH" speed position quickly. Vibration starts and the unit moves forward..

### STOPPING

1. Shift the throttle lever (Figure 4-2) to "LOW" speed position.
2. Allow the engine to run at low speed for 2-3 minutes before stopping.
3. Turn the STOP SWITCH (1, Figure 4-1) counterclockwise to the position "O"(OFF).
4. Close the fuel cock (1, Figure 4-2).



Do not stop engine suddenly while running at high speed

## SECTION 4 - OPERATING INSTRUCTIONS

---

### LONG STORAGE

# CAUTION

Discharge fuel (No Smoking !)

1. Remove the strainer cup of the fuel cock, place the strainer over a container and open the fuel cock to discharge fuel from the fuel tank. Remove the carburetor float chamber bolt from the bottom and discharge fuel from the carburetor
2. Close the fuel cock.
3. Change the engine oil.
4. Remove the spark plug, pour about 5 cc (0.2 ounces) of the engine oil into the cylinder, slowly pull the starter handle of the recoil starter 2 or 3 times, and re-install the spark plug.
5. Slowly pull the recoil starter handle until resistance is felt and leave it in that position.
6. Clean the unit and engine.
7. Store the unit and engine indoors in a well-ventilated, low humidity area. Use the cover to avoid dirt, etc. if storage will be for a long time.

# CAUTION

Always stop the engine and allow cooling down before covering the unit.



## SECTION 5 - FUEL AND LUBRICATION SPECIFICATIONS

---

Contents	Page
GENERAL INFORMATION _____	1
FLUID CAPACITIES _____	1

---

### GENERAL INFORMATION

Lubrication is an essential part of preventive maintenance, affecting to a great extent the useful life of the unit. Different lubricants are needed and some components in the unit require more frequent lubrication than others.

Specific recommendations of brand and grade of lubricants are not made here due to regional availability, operating conditions, and the continual development of improved products. Where questions arise, refer to the requirements and specifications in the engine manufacturer's manual.

All oil levels are to be checked with the machine parked on a level surface, and while the oil is cold, unless otherwise specified.

TABLE 5-1 FLUID CAPACITIES

FUEL/OIL	APPROXIMATE CAPACITY	
	MX-80	MX-90/110
ENGINE FUEL (Unleaded Gasoline) _____	2.5 liter	3.6 liter
VIBRATORY SHAFT CASE OIL(SAE 10W30) _____	0.2 liter	0.2 liter
ENGINE OIL (SAE 10W30) _____	0.6 liter	0.6 liter



**Fuel is flammable. May cause injury and property damage.**

**Shut down the engine, extinguish all open flames and do not smoke while filling the fuel tank.**

**Always wipe up any spilled fuel.**

1. Stop the engine and open the fuel tank cap.
2. Use the automobile unleaded gasoline only.
3. Close the fuel cock before filling the fuel tank.
4. When filling the fuel tank, always use the fuel filter.
5. Wipe off any spilled fuel before starting the engine.

## SECTION 6 - INITIAL BREAK-IN MAINTENANCE

---

Contents	Page
ENGINE OIL _____	1
GENERAL INFORMATION _____	2

---

### **⚠ WARNING**



**Improper maintenance can be hazardous.**

**Read and understand SECTION 1 - SAFETY PRECAUTIONS AND GUIDELINES before you perform any maintenance, service or repairs.**

---

### **ENGINE OIL**

Drain the engine oil after the first 20 hours of operation. Fill with the correct amount of the recommended oil. Check the oil level with the oil filler cap/dip stick. See Section 9.

### **⚠ WARNING**



**Hot oil and/or components can burn.**

**Oil must be at normal operating temperature when draining.**

**Avoid contact with hot oil or components.**

---

## SECTION 6 - INITIAL BREAK-IN MAINTENANCE

---

### GENERAL MAINTENANCE

Perform the following maintenance checks after the initial break in period.

1. Check Bolts and Nuts for looseness. Tighten it if necessary.
2. Check for fuel and oil leak.
3. Keep the RUBBER BUFFER away from oil and fuel.
4. Check the V-Belt for wear, damage and cracks. If necessary, replace the belt with new one.
5. Please refer to "Owner's Manual" for Honda GX120 for MX-80 and Honda GX160 for MX-90/110 regarding engine maintenance.

## SECTION 7 - TROUBLE SHOOTING - GENERAL MAINTENANCE

Contents	Page
TROUBLE SHOOTING	1
GENERAL MAINTENANCE	2

### TROUBLESHOOTING

1) Engine fails to start.

- |                            |  |
|----------------------------|--|
| a) Spark plug is defective | Clean or replace.                                      |
| b) Air in the fuel system. | Bleed air completely.                                  |
| c) Fuel tank is empty.     | Fill Tank  |
| d) Carburetor is clogged   | Clean or replace, if necessary.                        |
| e) Excessive fuel.         | Open fuel drain cock and drain fuel. Clean spark plug. |

2) Engine runs irregularly.

- |                                    |   |
|------------------------------------|---|
| a) Fuel line sucks air.            | Retighten the fuel pipe joints and bleed air.         |
| b) Air cleaner is clogged.         | Clean air cleaner or replace element.                 |
| c) Engine stalls during operation. | Clean fuel system and retighten the fuel pipe joints. |
| d) Low compression.                | Replace head gasket or retighten spark plug.          |

3) Machine fails to vibrate.

- |                                   |                                    |
|-----------------------------------|------------------------------------|
| a) Incorrect setting              | RPM of engine. Adjust.             |
| b) Throttle cable is slacked.     | Adjust.                            |
| c) Centrifugal clutch is slipped. | Overhaul or replace, if necessary. |
| d) Belt is slipped.               | Adjust or replace, if necessary.   |

4) The traveling is bad or the vibration is diffuse.

- |                                     |                                       |
|-------------------------------------|---------------------------------------|
| a) Incorrect setting RPM of engine. | Adjust.                               |
| b) Air cleaner is clogged.          | Clean air cleaner or replace element. |
| c) Centrifugal clutch is slipped.   | Overhaul or replace, if necessary.    |
| d) Belt is slipped.                 | Adjust or replace, if necessary.      |

## SECTION 7 - TROUBLE SHOOTING - GENERAL MAINTENANCE

---

### GENERAL MAINTENANCE

1. Engine RPM is adjusted to as below:  
    LOW 1400 - 1500 rpm  
    HIGH 3700 – 3800 rpm
2. Check Bolts and Nuts for looseness. Tighten it if necessary.
3. Check for fuel and oil leak.
4. Keep the RUBBER BUFFER away from oil and fuel.
5. Check the V-Belt for wear, damage and cracks. If necessary, replace with a new belt.
6. Please refer to “Owners Manual” for Honda engine for maintenance instructions for the engine on your machine.

If you need engine parts list, please refer to the website of engine maker

<http://cssportal.css-club.net/honda/PowerProducts/TERMS010.aspx>

HONDA

### AIR CLEANER

## CAUTION

**If the air cleaner element is seriously contaminated, start-up failure, poor output and engine malfunction may result.**

**Never run the engine without the air cleaner. Rapid engine wear will result.**

- 
7. Keep the air cleaner element clean. Refer to Section 8.

## SECTION 8 - 10 HOUR OR DAILY ROUTINE MAINTENANCE

---

---

Contents	Page
ENGINE OIL _____	1
AIR CLEANER _____	1
FASTENING HARDWARE _____	2

---

### **⚠ WARNING**



**Improper maintenance can be hazardous.**

**Read and understand SECTION 1 - SAFETY PRECAUTIONS AND GUIDELINES before you perform any maintenance, service or repairs.**

---

It is recommended that the following steps be performed at the beginning and end of each 8 to 10 hour shift or daily, whichever comes first.

#### **ENGINE OIL**

Check the engine's oil level at the start of each day and maintain it to the full mark on the dipstick. Insert the dipstick and check the full mark on the dipstick. See Section 9.

#### **AIR CLEANER**

### **⚠ WARNING**

**Never use gasoline or low flash point solvents to clean the filter. a fire or explosion may result.**

---

### **⚠ CAUTION**

**If the air cleaner element is seriously contaminated, start-up failure, poor output and engine malfunction may result.**

**Never run the engine without the air cleaner. Rapid engine wear will result.**

---

If the machine is operating in a dusty environment, check the air cleaner daily. Keep the Air Cleaner Element clean.

To Clean the Air Cleaner:

## SECTION 8 - 10 HOUR OR DAILY ROUTINE MAINTENANCE

**Figure 8-1**

1. Remove the wing nut (13, Figure 8-1) and air cleaner cover (4).

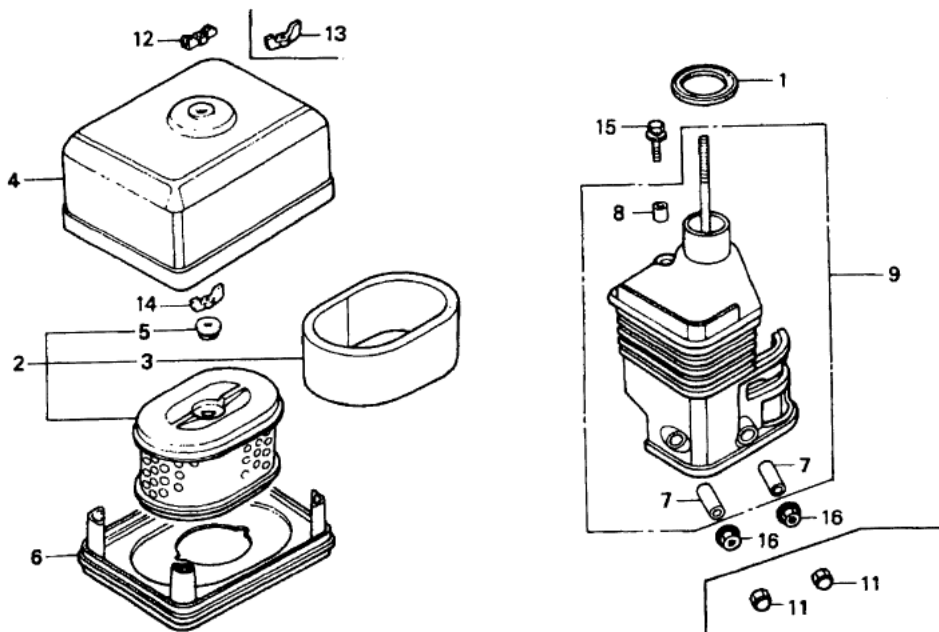

No.	Parts No.	Detail	QTY
1	16271-ZE1-000	PACKING	1
2	17210-ZE1-517	AIR CLEANER ELEMENT	1
3	17218-ZE0-821	FILTER, OUTER	1
4	17230-ZE0-820	FILTER COVER	1
5	17232-891-000	GROMMET	1
6	17235-ZE1-831	SILENCER NOSE	1
7	17238-ZE0-010	COLLAR	2
8	17239-ZE1-000	COLLAR (B)	1
9	17410-ZE0-030	AIR CLEANER ELBOW	1
11	90201-415-000	CAP NUT	2
12	90203-ZAO-800	WING NUT	1
13	90325-044-000	NUT, TOOL BOX SETTING	1
14	90325-044-000	NUT, TOOL BOX SETTING	1
15	93494-66020-08	BOLT	1
16	94050-06000	FLANGE NUT	2

2. Remove the element assembly (2).
3. Check element for holes or tears and replace if necessary.
4. To clean the element wash in a solution of household detergent and warm water, then rinse thoroughly or wash in a nonflammable solvent. Allow drying thoroughly. Soak the element in clean engine oil and squeeze out excess oil. Too much oil will cause engine to smoke on initial start-up.
5. Do not use a brush to remove dirt. This can push dirt into the fibers. Replace the filter if it is excessively dirty.
6. Wipe out the inside of the cover with a damp cloth.
7. Reassemble the air cleaner.

### **FASTENING HARDWARE**

Check all fastening hardware to ensure it is all adequately tightened and that none is missing or broken.



## SECTION 9 - 50 HOUR OR WEEKLY ROUTINE MAINTENANCE

---

Contents	Page
ENGINE OIL _____	1
CHANGE ENGINE OIL _____	2

---

### CHECK ENGINE OIL

## ⚠ CAUTION

Running the engine with insufficient oil can cause serious engine damage.

Be sure machine is on a firm level surface and stopped.

---

1. Place the machine on a stable level surface and stop the engine
2. Remove oil filler cap/dipstick (1, Figure 9-1) and wipe off the dipstick (2)

Figure 9-1

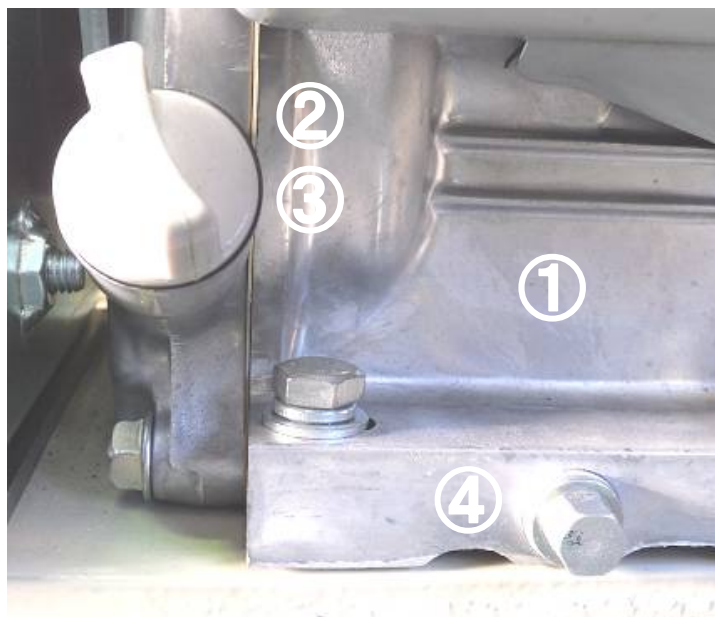

3. Place the dipstick back into the engine but do not screw it in. Remove the dipstick and check the oil level.
4. If the level is low, fill to the top of the oil filler neck (3, Figure 9-1) with the recommended oil.
5. Place the oil filler cap/dipstick into the engine and screw it into place. Wipe up any excess oil.

## SECTION 9 - 50 HOUR OR WEEKLY ROUTINE MAINTENANCE

---

### CHANGE ENGINE OIL

# CAUTION

**Running the engine with insufficient oil can cause serious engine damage.**

**Be sure machine is on a firm level surface and stopped.**

---

1. Stop the engine, loosen and remove the drain plug (4, Figure 9-1), drain the oil and reinstall the drain plug before refilling with oil.
2. Fill to the top of the oil filler neck (3, Figure 9-1) with the recommended oil. Install the filler cap/dipstick (2, Figure 9-1).

Always use the best grade of fresh, clean oil. Contaminated oil, poor quality oil and shortage of oil will cause damage to engine or shorten the engine life.

ENGINE OIL (SAE 10W30)

(0.60liters) BX80/90/110

Use class SE, SF (API classification) or higher grade oil.

Initial oil change ..... After 20 hours of operation.

Thereafter ..... Every 50 hours of operation.

**SECTION 10 - 100 HOUR OR MONTHLY ROUTINE MAINTENANCE**

---

**NOTE**

**\* No 100 Hour or Semi-Annual Routine Maintenance is required.\***

**SECTION 11 - 250 HOUR OR QUARTERLY ROUTINE MAINTENANCE**

---

**NOTE**

**No 250 Hour or Semi-Annual Routine Maintenance is required.\***

**SECTION 12- 500 HOUR OR SEMI-ANNUAL ROUTINE MAINTENANCE**

---

**NOTE**

**No 500 Hour or Semi-Annual Routine Maintenance is required. \***

**SECTION 13 - 1000 HOUR OR ANNUAL ROUTINE MAINTENANCE**

---

**NOTE**

**\* No 1000 Hour or Annual Routine Maintenance is required.\***

## SECTION 14 - ROUTINE ADJUSTMENTS

---

### ENGINE RPM

Adjust the engine rpm per specifications and productions in the engine manual.

### V-BELT TENSION

Adjust the v-belt tension so that a light pressure on the belt between the two pulleys deflects the belt 3/16 to 3/8 inch (5 to 10 mm)

**SECTION 15 - MISCELLANEOUS AND OPTIONAL EQUIPMENT**

---

**NOTE**

**No Miscellaneous or Optional Equipment \***



## SECTION 16 - SCHEMATICS

---

### NOTE

No Schematics are necessary for this unit. \*



