



## **USER MANUAL**

LED Lighting Kit with Hand Wave Activation

*Dimmable*

30cm/11.8" 1 pack

---

---

Thank you for choosing a product of the brand **EShine**. Before starting up the lights read through the instructions and store it for future reference.

Packaging content:

- 1 x LED strip light
- 3 x Wire clips
- 1 x 3M double-sided sticker
- 2 x Screws
- 2 x Screw caps
- 1 x 12W power supply

## **Technical specifications**

Dimensions: 28.6(W) x 9.6(H) x 300 (L) mm

Material: Plastic and Aluminum

Operating voltage: 12V DC

Power: 3.5W

Dimmable: Yes

Color temperature: Warm white (3000K) or Cool White (6000K)

Rated life: > 25,000 h

Switching cycles: > 15,000

Nominal luminous flux: 230lm

Angle: 120 °

Protection: IP20

Protection class: III

Operating temperature: -20 ° C to + 45 ° C

---

## Precautions

- Please check the lamp carefully before installing.
- Ensure the power is off before wiring and installing.
- This LED strips must be operated with **12V DC voltage**.
- Please do not open the LED strips.
- Please do not retrofit the lamp within warranty period
- Please use this product for indoor only!
- Warning! The packaging contains small parts. Not for children.
- The LED under cabinet light is equipped with IR sensor a so-called " Hand wave on/off ". The LED lights turn on/off by waving your hand under IR sensor, which built in the middle.

## Important tip before installing your lighting system



Make sure there are **NO** objects within **4 inches** from the sensor (**for example: wall, wood board, any supplies, cabinet lip, etc**).

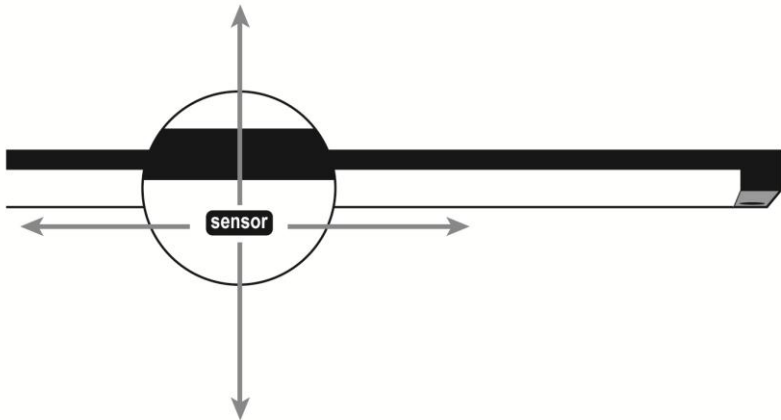

---

**1.** Use screws or 3M double-sided stickers to fasten lights to the installation location (see Pic.1).

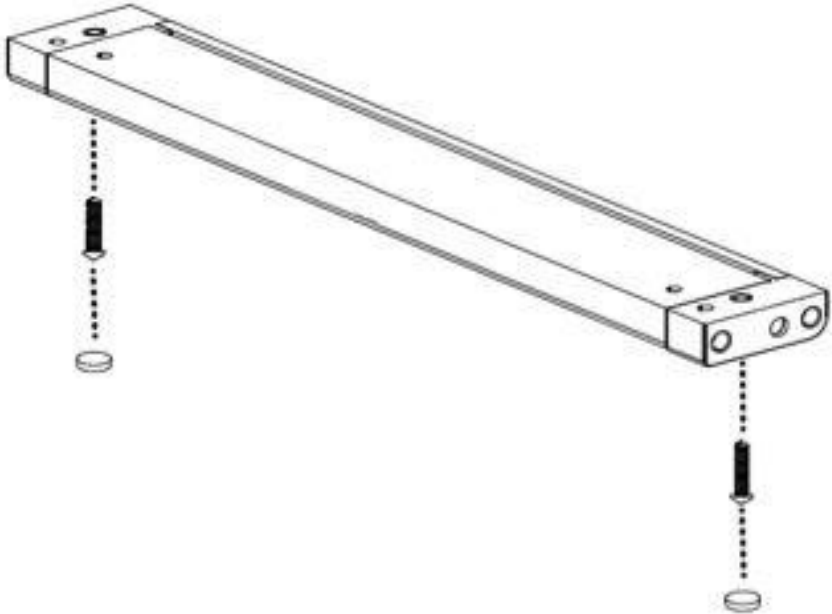

Pic.1 Installation with screws

---

**2.** You can use connections cables or connectors to install additional lights (see Pic.2, 3). If you use cables, wire clips included for comfortable installation.

*Maximum allowed 11.8" LED strip lights for 12W adapter is 3.*

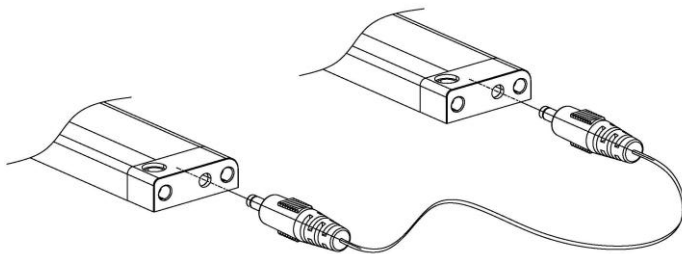

Pic.2 Connection cables

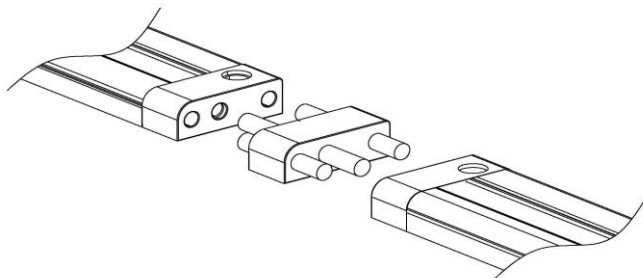

Pic.3 Connectors

---

**3.** The main plug of the 12V power supply must be connected to a specially marked side of LED strip with IR sensor. This strip is labeled with the following note: " Connect power". On the marked side, please connect the power cord (see Pic.4).

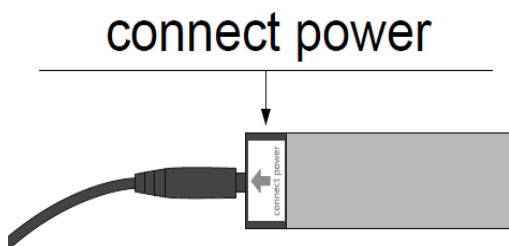

Pic.4: Connection of the power plug to the bar with IR sensor

*Note: If you connect the power cord on the wrong side or wrong led bar, which is not marked, NO IR sensor ("hand wave on/off") will be functional, but light can be operated with regular switch or just plug/unplug adapter.*

---

**4.** After connecting the power cord, to turn on the light wave your hand under IR sensor. (see Pic.5)

The sensing distance is 6-8 cm from IR sensor.

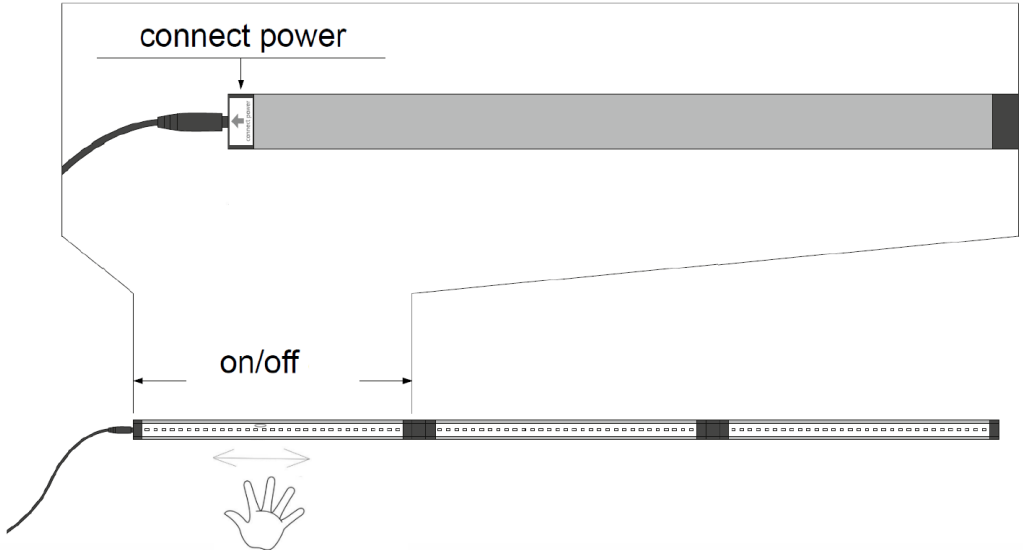

Pic.5 On/Off function

**IMPORTANT:** Make sure there are no objects within 4 inches from the sensor (wall, wood board, any supplies, cabinet lip etc).

---

**5.** Hold your hand under the sensor for more than 1 sec to adjust brightness of all lights from 10% to 100% level. When you turn lights on/off, it will remember your last used brightness level.

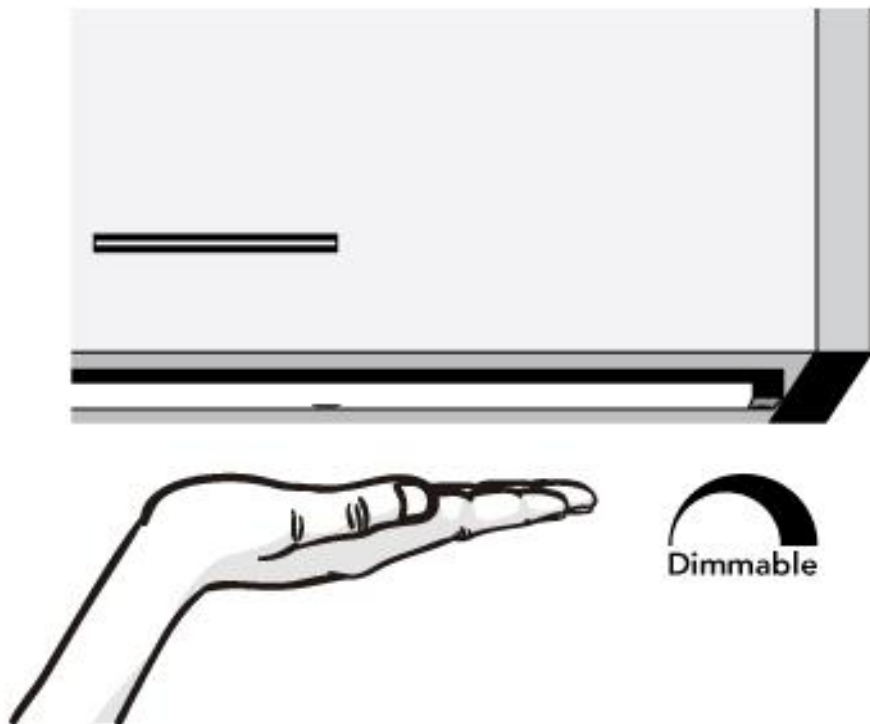

Pic.6 Dimmable function



---

**6.** To ensure better lighting, please clean the lamp at regular intervals.

*Before you clean the LED lights ensure that the power is off. Absolutely avoid when cleaning the lights wearing metallic or conductive jewelry such as bracelets, necklaces, rings etc. A soft dry cloth is recommended for cleaning.*

*Please do not install the LED lights close to heat sources or on open fires.*

---

## **7.** EShine LED Lighting Kit comes with Limited 3-Years Warranty.

### ***What does this limited warranty cover?***

*This Limited Warranty covers any defects in material or workmanship under normal use during the Warranty Period.*

### ***What will we do to correct problems?***

*During the Warranty Period, we will repair or replace, at no charge, products or parts of a product that proves defective because of improper material or workmanship, under normal use and maintenance.*

### ***How long does the coverage last?***

*The Warranty Period for this LED lighting kit is 3 years from the date of purchase.*

### ***What does this limited warranty not cover?***

*This Limited Warranty does not cover any problem that is caused by:*

- *conditions, malfunctions or damage not resulting from defects in material or workmanship*

### ***What do you have to do?***

*To obtain warranty service, you must first contact us to determine the problem and the most appropriate solution for you.*

EShine®

Web: [www.eshinestore.com](http://www.eshinestore.com)

Email: [service@eshinestore.com](mailto:service@eshinestore.com)