



USER MANUAL

LED Lighting Kit with Hand Wave Activation

Dimmable

100cm/39.4" 1 pack

Thank you for choosing a product of the brand **EShine**. Before starting up the lights read through the instructions and store it for future reference.

Packaging content:

- 1 x LED strip light
- 3 x Wire clips
- 1 x 3M double-sided sticker
- 2 x Screws
- 2 x Screw caps
- 1 x 12W power supply

Technical specifications

Dimensions: 28.6(W) x 9.6(H) x 1000 (L) mm

Material: Plastic and Aluminum

Operating voltage: 12V DC

Power: 10W

Dimmable: Yes

Color temperature: Warm white (3000K) or Cool White (6000K)

Rated life: > 25,000 h

Switching cycles: > 15,000

Nominal luminous flux: 800lm

Angle: 120 °

Protection: IP20

Protection class: III

Operating temperature: -20 ° C to + 45 ° C

Precautions

- Please check the lamp carefully before installing.
- Ensure the power is off before wiring and installing.
- This LED strips must be operated with **12V DC voltage**.
- Please do not open the LED strips.
- Please do not retrofit the lamp within warranty period
- Please use this product for indoor only!
- Warning! The packaging contains small parts. Not for children.
- The LED under cabinet light is equipped with IR sensor a so-called " Hand wave on/off ". The LED lights turn on/off by waving your hand under IR sensor, which built in the middle.

Important tip before installing your lighting system



Make sure there are **NO** objects within **4 inches** from the sensor (for example: wall, wood board, any supplies, cabinet lip, etc).

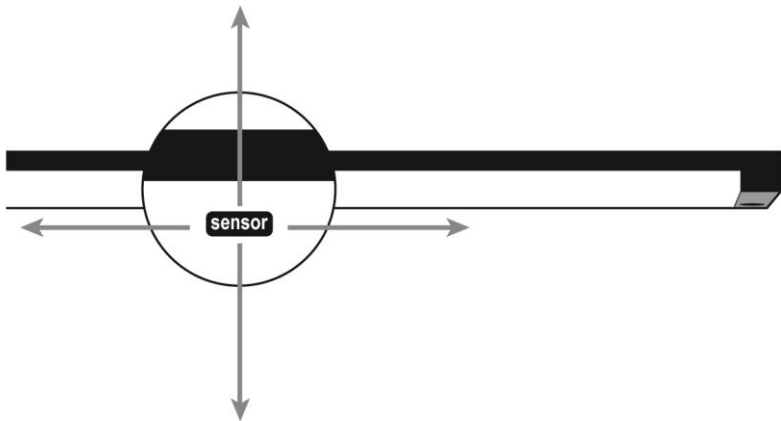

1. Use screws or 3M double-sided stickers to fasten lights to the installation location (see Pic.1).

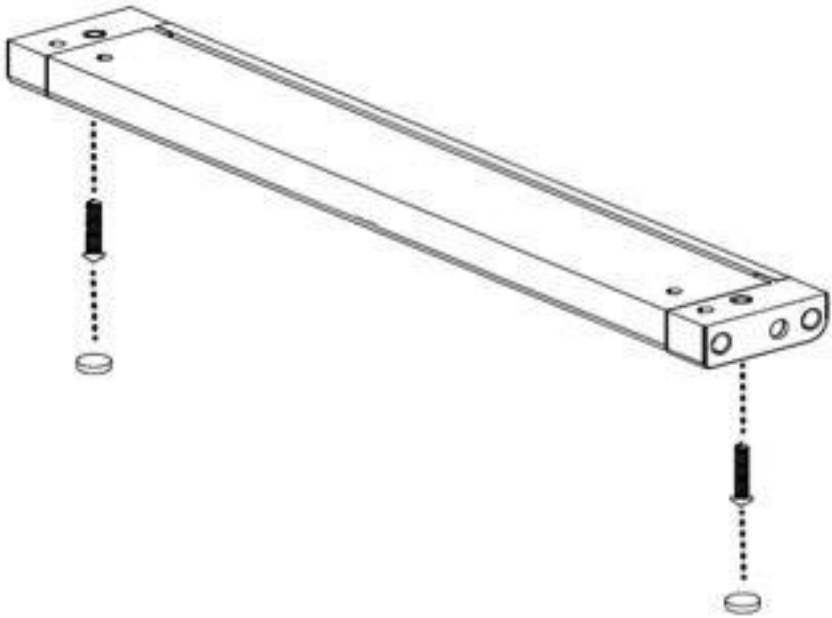

Pic.1 Installation with screws

2. You can use connections cables or connectors to install additional lights (see Pic.2, 3). If you use cables, wire clips included for comfortable installation.

Maximum allowed 39.4" LED strip lights for 12W adapter is 1.

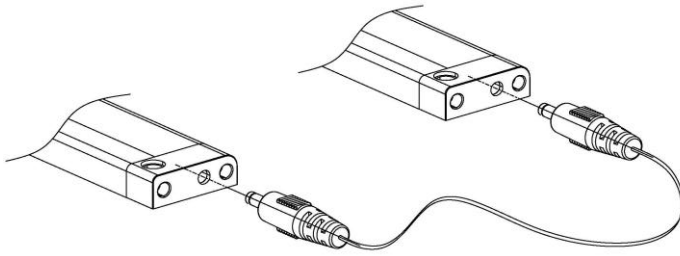

Pic.2 Connection cables

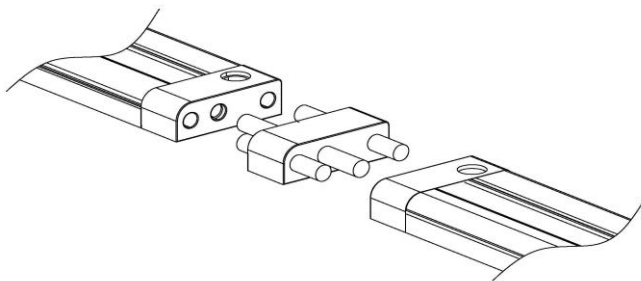

Pic.3 Connectors

3. The main plug of the 12V power supply must be connected to a specially marked side of LED strip with IR sensor. This strip is labeled with the following note: " Connect power". On the marked side, please connect the power cord (see Pic.4).

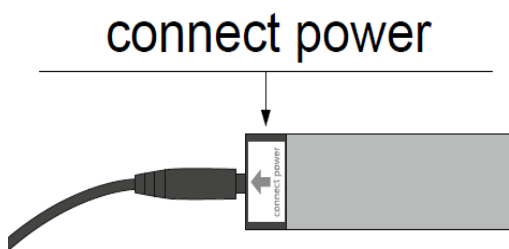

Pic.4: Connection of the power plug to the bar with IR sensor

Note: If you connect the power cord on the wrong side or wrong led bar, which is not marked, NO IR sensor ("hand wave on/off") will be functional, but light can be operated with regular switch or just plug/unplug adapter.

4. After connecting the power cord, to turn on the light wave your hand under IR sensor. (see Pic.5)

The sensing distance is 6-8 cm from IR sensor.

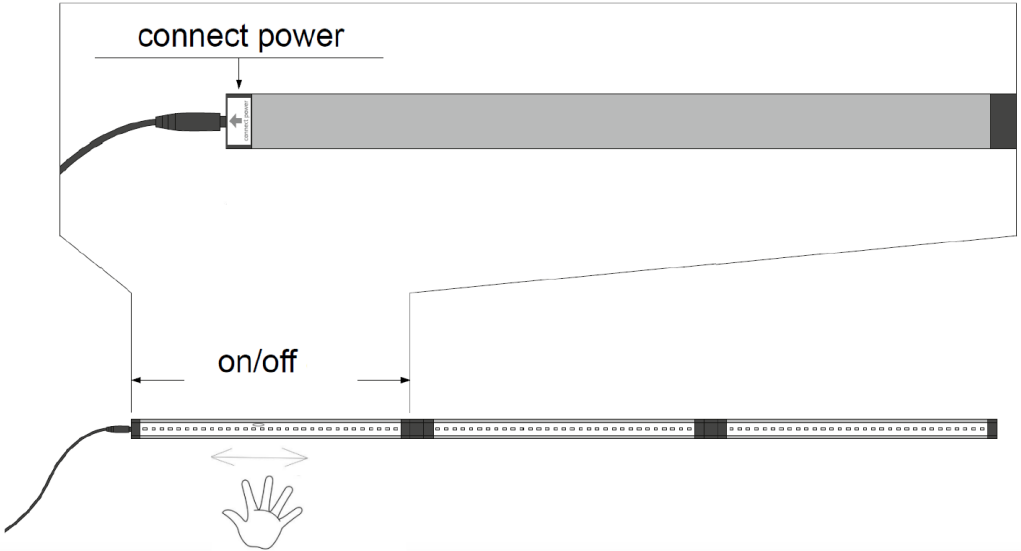

Pic.5 On/Off function

IMPORTANT: Make sure there are no objects within 5 inches from the sensor (wall, wood board, any supplies, etc).

5. Hold your hand under the sensor for more than 1 sec to adjust brightness of all lights from 10% to 100% level. When you turn lights on/off, it will remember your last used brightness level.

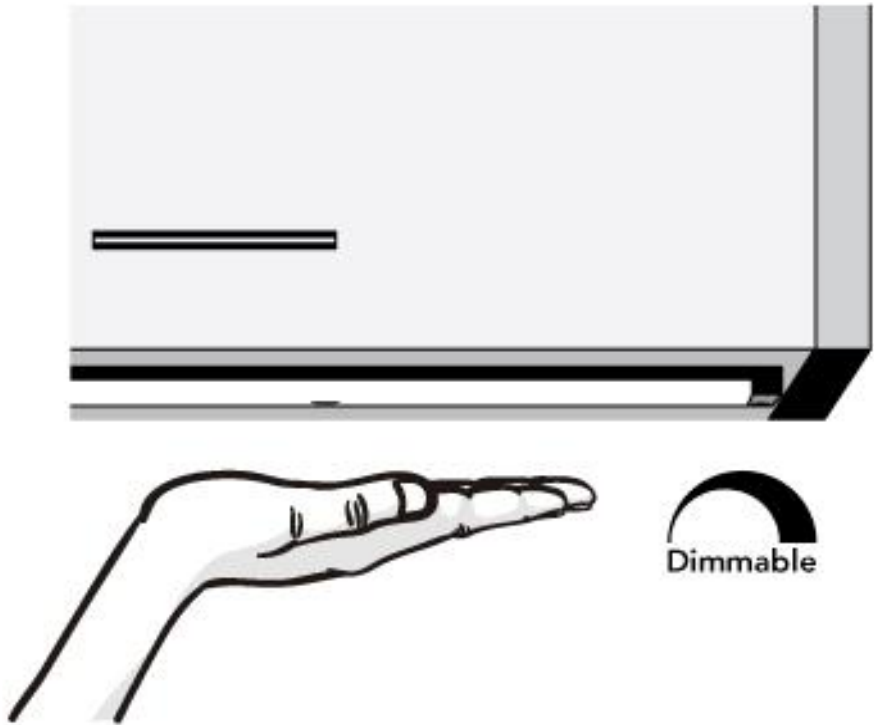

Pic.6 Dimmable function

6. To ensure better lighting, please clean the lamp at regular intervals.

Before you clean the LED lights ensure that the power is off. Absolutely avoid when cleaning the lights wearing metallic or conductive jewelry such as bracelets, necklaces, rings etc. A soft dry cloth is recommended for cleaning.

Please do not install the LED lights close to heat sources or on open fires.

7. EShine LED Lighting Kit comes with Limited 3-Years Warranty.

What does this limited warranty cover?

This Limited Warranty covers any defects in material or workmanship under normal use during the Warranty Period.

What will we do to correct problems?

During the Warranty Period, we will repair or replace, at no charge, products or parts of a product that proves defective because of improper material or workmanship, under normal use and maintenance.

How long does the coverage last?

The Warranty Period for this LED lighting kit is 3 years from the date of purchase.

What does this limited warranty not cover?

This Limited Warranty does not cover any problem that is caused by:

- *conditions, malfunctions or damage not resulting from defects in material or workmanship*

What do you have to do?

To obtain warranty service, you must first contact us to determine the problem and the most appropriate solution for you.

EShine®

Web: www.eshinestore.com

Email: service@eshinestore.com