



KM-520/660MAJ-E

SLIM-LINE MODULAR CRESCENT CUBER



KM-520/660MAJ-E
01/28/19
Item # 13460

Item #: _____
 Project: _____
 Qty: _____
 AIA#: _____

W x D x H
559 x 695 x 711 mm

KM||EDGE X

ICE MACHINE SERIES

Air-Cooled

KM-520MAJ-E
KM-660MAJ-E

Shown on optional bin: B-300







Available on Bins/Dispensers:

B-250PF B-700PF/SF B-1150SS DB-200H
B-300PF/SF B-800PF/SF B-1300SS DM-200B
B-500PF/SF B-900PF/SF DB-130H

Top kit may be required. See bin spec sheets.

Features

- ▶ Individual crescent cube
- ▶ Factory-installed ultrasonic bin control can be adjusted on site
- ▶ Simple, one-hour cleaning process 

- Durable construction with fewer parts
- Self-diagnostic programming automatically adjusts to changing conditions
- Snap fit parts for easy cleaning
- Stainless steel double-sided evaporator
- CycleSaver™ design 
- Protected by H-GUARD Plus  Antimicrobial Agent
- EverCheck™ alert system 
- Removable air filters (air-cooled model only)
- Power cord is 3000mm long with Type G plug
- R-404A Refrigerant



Warranty:

Call factory for information.

Shipping: (LxWxH) 846 x 652 x 875 mm Volume: 0.492m³

Condenser	Model	ICE PRODUCTION		WATER USAGE		ELECTRICAL							
		Air / Water Temp kg per 24 hours 21°/10°C 32°/21°C		Potable liters per 45 kg 32°/21°C	Condenser liters per 45 kg 32°/21°C	kWh Used per 45 kg 32°/21°C	Min. Circuit Amp - Max. Fuse/Breaker	Amperage	Voltage	Circuit Wires (including ground)	Heat Rejection BTU/hr.	Refrigerant Charge Amount	Net / Ship Weight (kg)
Air	KM-520MAJ-E	238	197	108	N/A	6.52	15A	8.4A	220-240V/50/1	3	7,300	500g	59 / 68
Air	KM-660MAJ-E	280	262	52	N/A	4.85	15A	8.4A	220-240V/50/1	3	7,300	760g	59 / 68

Power cord included.

KM Edge Cube Dimensions*

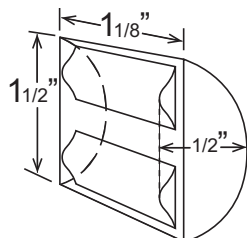

* approximate size in inches, image not to scale

Operating Limits

- Ambient Temp Range 7 - 38°C
- Water Temp Range 7 - 32°C
- Water Pressure 69 - 779KPa
- Voltage Range 198-254V

Service

- Panels easily removed and all components accessible for service.
- Allow 15 cm (6") clearance at rear, sides, and top for proper air circulation and ease of maintenance/service.

Plumbing

- Icemaker Water Supply Line: Minimum 6 mm Nominal OD Copper Water Tubing or Equivalent
- Icemaker Drain Line: Minimum 18 mm Nominal OD Hard Pipe or Equivalent

Water Filter

Please refer to water filter specification sheet for recommendations.



KM-520/660MAJ-E

SLIM-LINE MODULAR CRESCENT CUBER



KM-520/660MAJ-E
01/28/19
Item # 13460

FRONT VIEW

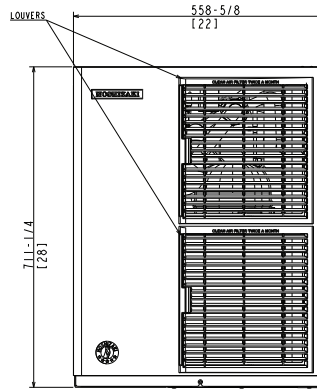

mm
[inch]

SIDE VIEW

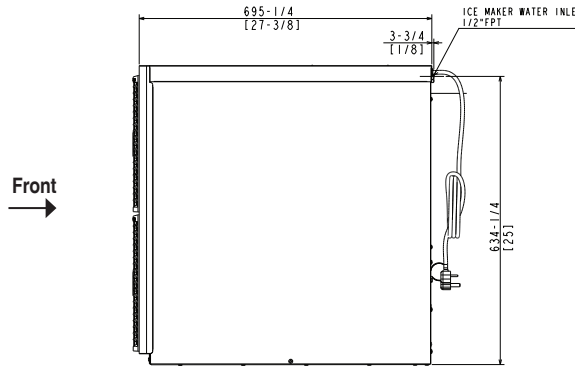

REAR VIEW

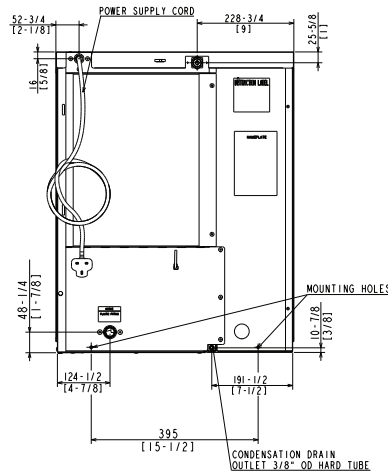

BOTTOM VIEW

