

PROJECT:	_____
LOCATION:	_____
ITEM#:	_____
QUANTITY:	_____

**COMPETITOR SERIES®**

**C-CR24**

**C-CR36**

**C-CR48**

# CHAR-ROCK BROILERS

- Reversible heavy duty cast iron cooking grates with angled sides for flat or sloped positions
- Cast iron grates underneath cooking grates to support char-rocks and proper airflow
- Manually controlled cooking zones
- 35,000 BTU per “U” shape burner
- Removable, full width slide out waste tray
- Beautiful ergonomic design and easy to clean
- High polished, stainless steel exterior and chrome temperature knobs
- (4) adjustable stainless steel feet
- Comes standard as natural gas with L.P orifice kit for in-field conversion
- Migali Industries® Protection Plan: 1 Year Parts & Labor Warranty

MODEL	BURNERS	TOTAL BTU NATURAL GAS / LP	PER BTU NATURAL GAS / LP	IN TAKE TUBE PRESSURE (W.C.) NATURAL GAS / LP	NOZZLE NO. NATURAL GAS / LP	IGNITION	VALVE TYPE	WORKING AREA W X D	EXTERIOR DIMENSIONS W X D X H	PACKAGING DIMENSIONS W X D X H	WEIGHT	PACKAGED WEIGHT
C-CR24	2	70,000	35,000	4 /10	#36 / #50	Manual	Pilot Light	23.9” x 20.2”	24 x 27.6 x 15.2	26.8 x 29.9 x 18.2	137 lbs.	168 lbs.
C-CR36	3	105,000	35,000	4 /10	#36 / #50	Manual	Pilot Light	35.7” x 20.2”	36 x 27.6 x 15.2	38.6 x 29.9 x 18.2	191 lbs.	238 lbs.
C-CR48	4	140,000	35,000	4 /10	#36 / #50	Manual	Pilot Light	47.9” x 20.2”	48 x 27.6 x 15.2	50.8 x 29.9 x 18.2	248 lbs.	314 lbs.

Gas Connection: 3/4” NPT on the right

Clearance for combustible work area: 6” rear & 15” sides

Altitudes over 2,000 feet may need high altitude orifice adjustments to deliver BTU output listed

\*MIGALI RESERVES THE RIGHT TO CHANGE SPECIFICATIONS WITHOUT NOTICE

# DIMENSIONAL DRAWINGS

C-CR24

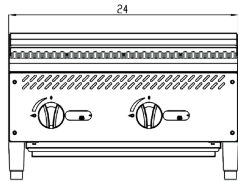

C-CR36

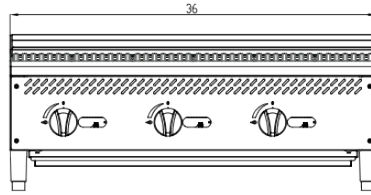

C-CR48

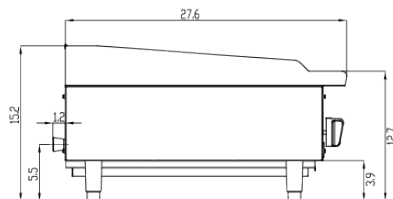
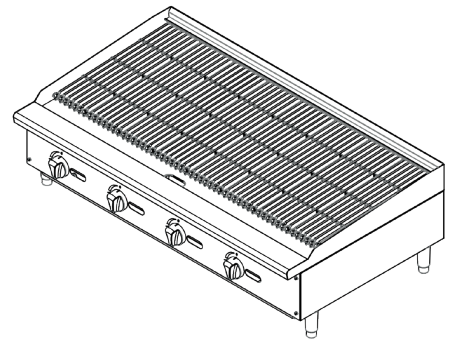
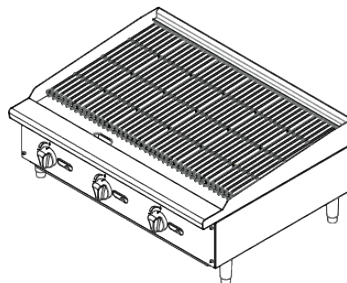
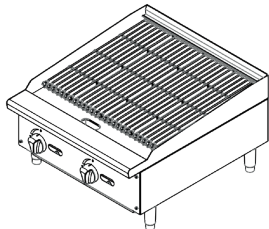
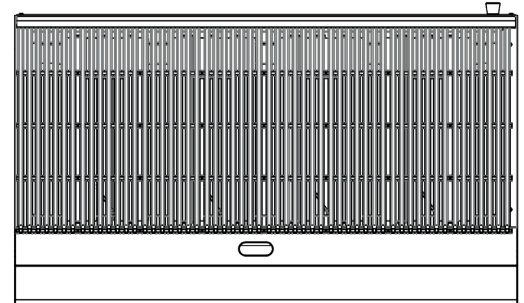
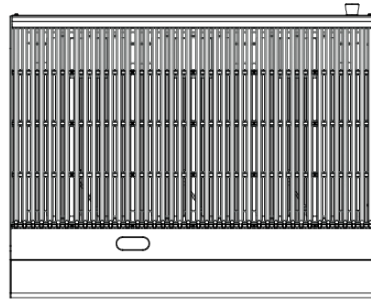
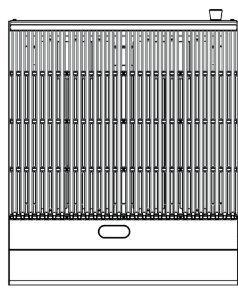
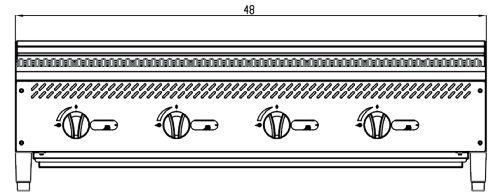

SIDE VIEW



MIGALI® REMAINS AN AMERICAN FAMILY COMPANY SINCE 1955