

iT1500 Ice Cube Machine

Models

- IDT1500A IDT1500W IDT1500N
- IYT1500A IYT1500W IYT1500N



Indigo NXT Series iT1500 Ice Machine on D970 Bin
*Ice machine and bin sold separately

Designed for operators who know that ice is critical to their business, the Indigo NXT Series ice machine's preventative diagnostics continually monitor itself for reliable ice production. Improvements in cleanability and programmability make your ice machine easy to own and less expensive to operate.

- **New levels of Performance** - Showcasing an average of 6% lower energy consumption, up to 9% increase in ice production and a 9% reduction in condenser water usage. This translates into lower cost of ownership over the life of your machine.
- **easyTouch[®] Display** - New icon based touch screen takes the guess work out of owning and operating an ice machine.
- **Programmable Ice Production** - Now its super easy to program your ice machine to be off at certain times of the day to save money with fluctuating electrical rates. Also programmable by daily ice production volume and night time programming.
- **Easy to Clean Foodzone** - Easy Access front door panel. Removable water-trough, distribution tube, curtain, and sensing probes for fast and efficient cleaning. Select components made with AlphaSan[®] antimicrobial.
- **Intelligent Diagnostics** - Provides 24 hour preventative maintenance and diagnostic feedback for trouble free operation.
- **Acoustical Ice Sensing Probe** - Unique patented technology allows for reliable operation in challenging water conditions and environments.
- **DuraTech[®] Exterior** - Provides superior corrosion resistant above stainless steel. Innovative clear-coat resists fingerprints and dirt making it easier to keep clean.
- Available **LuminIce[®] II Virus and Bacteria Inhibitor** - Controls viruses, bacteria, mold, and yeast within the food zone to keep the ice machine clean longer. A new sanitation icon lets you know the operational status.
- **Active Sense** - insures consistent ice harvest in all environmental conditions. This software works in conjunction with the acoustical ice sensing probe improving reliability and performance.

Ice Machine Electric

208-230/60/1 standard
(208-230/60/3 also available.)

Minimum circuit ampacity:

Air-cooled:	18.5 1ph	13.4 3ph
Water-cooled:	17 1ph	12.0 3ph
Remote-cooled:	15.3 1ph	13.0 3ph

Maximum fuse size:

Air-cooled:	30 1ph	20 3ph
Water-cooled:	30 1ph	20 3ph
Remote-cooled:	25 1ph	20 3ph



Specifications

BTU Per Hour:
23,000 (average),
and 27,000 (peak)

Refrigerant:
R-410 CFC-free

Operating Limits:

- Ambient Temperature Range:
40 to 110 F (4.4 to 43.3 C)
Water Temperature Range:
40 to 90 F (4.4 to 32.2 C)
- Potable Water Pressure:
Min. 20 psi (137.9 kPa)
Max. 80 psi (551.1 kPa)
- Condenser Water Pressure:
Min. 20 psi (137.9 kPa)
Max. 276 psi (551.1 kPa)

Ice Shape

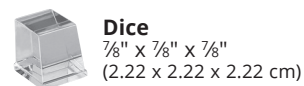
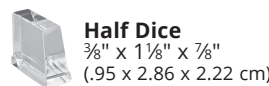



iT1500 on D970 Storage Bin

- Ⓐ Electrical Entrance (2) Options
- Ⓑ 1/2" (1.27 cm) F.P.T. Water Condenser Outlet (water-cooled units)
- Ⓒ 3/8" (0.95 cm) F.P.T. Water Condenser Inlet (water-cooled units)
- Ⓓ 3/8" (0.95 cm) F.P.T. Ice Making Water Inlet
- Ⓔ 1/2" (1.27 cm) F.P.T. Ice Making Water Drain
- Ⓕ 1/2" (1.27 cm) Auxillary Base Drain Socket
- Ⓖ 3/4" (1.91 cm) Bin Drain

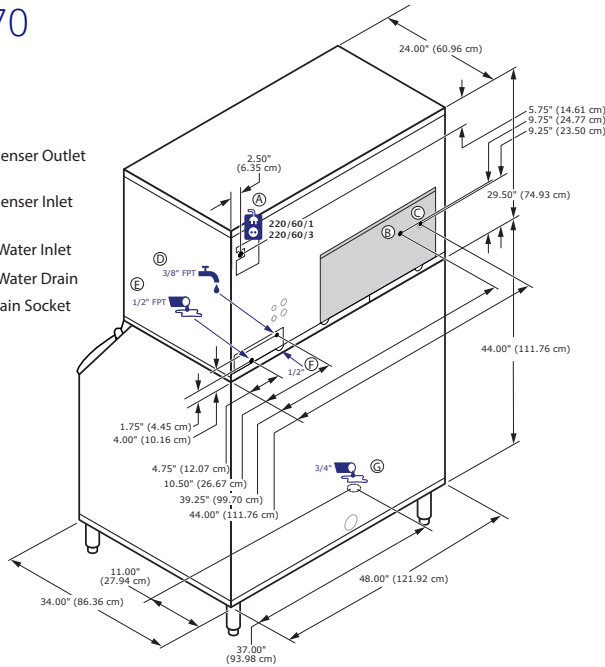

Installation Note

Air Cooled clearance:

- Top: 8" (30.5 cm)
- Sides: 8" (20.3 cm)
- Back: 5" (30.5 cm)

Water Cooled

clearance:

- Top/Sides: 8" (20.3 cm)
- Back: 5" (12.7 cm)

Space-Saving Design



	iT1500 D970
Height	79.50" / 201.90 cm
Width	48.00" / 121.92 cm
Depth	34.00" / 86.30 cm
Bin Storage	882lbs / 400kgs

Height includes adjustable bin legs 6.00" to 8.00", (15.24 to 20.32 cm) set at 6.00" (15.24 cm). Application Capacity- measured 90% of total volume in cubic feet x 33lbs/lbs ft³

Specifications

Model	Ice Shape	Ice Production 24 Hours				Power Usage kWh/100 lbs. @90°Air/70°F		Potable Water Usage/100 lbs. 45.4 kgs. of Ice
		70°Air/ 50°F Water		90°Air/ 70°F Water		1 Ph	3 Ph	
		1 Ph	3 Ph	1 Ph	3 Ph			
IDT1500A	dice	1,688 lbs.	1,830 lbs.	1,350 lbs.	1,380 lbs.	4.66	4.33	20 Gal.
		766 kgs	830 kgs	612 kgs	626 kgs			75.7 L
IYT1500A	half-dice	1,660 lbs.	1,931 lbs.	1,412 lbs.	1,438 lbs.	4.49	4.33	20 Gal.
		753 kgs	876 kgs	640 kgs	652 kgs			75.7 L
IDT1500W	dice	1,615 lbs.	1,744 lbs.	1,390 lbs.	1,472 lbs.	3.63	3.42	20 Gal.
		733 kgs	791 kgs	630 kgs	668 kgs			75.7 L
IYT1500W	half-dice	1,590 lbs.	1,770 lbs.	1,392 lbs.	1,590 lbs.	3.55	3.2	20 Gal.
		721 kgs	803 kgs	631 kgs	721 kgs			75.7 L
* Water-cooled Condenser Water Usage / 100 lbs. /45.4 kgs. Of Ice: 140 gal./ 530 L.								
* Water-cooled models are excluded from ENERGY STAR qualification.								
IDT1500N	dice	1,675 lbs.	1,786 lbs.	1,450 lbs.	1,523 lbs.	4.0 ★	3.9 ★	20 Gal.
		760 kgs	810 kgs	658 kgs	691 kgs			75.7 L
IYT1500N	half-dice	1,700 lbs.	1,817 lbs.	1,450 lbs.	1,533 lbs.	4.09 ★	4.0 ★	20 Gal.
		771 kgs.	824 kgs.	658 kgs	695 kgs.			75.7 L

Order separately: Ice storage bin for all units, line-set and remote condenser unit JCT1500 for remote cooled units.



Accessories

LuminIce[®] II Virus and Bacteria Inhibitor

controls viruses and bacteria in the ice machine.



External Scoop holder

protect the ice scoop with the NSF approved versatile scoop holder.



Arctic Pure[®] Water Filters

reduces sediment and chlorine odors for better tasting ice.



iAuCS[®]

schedules and performs routine ice machine cleaning automatically.



Welbilt reserves the right to make changes to the design or specifications without prior notice.