



Item: _____

Quantity: _____

Project: _____

48" Gas Restaurant Range

48" Gas Restaurant Range

Models:	<input type="checkbox"/> RR-8	<input type="checkbox"/> RR-6G12	<input type="checkbox"/> RR-4G24	<input type="checkbox"/> RR-2G36	<input type="checkbox"/> RR-G48	
	<input type="checkbox"/> RR-4RG24	<input type="checkbox"/> RR-8SU	<input type="checkbox"/> RR-6GT12	<input type="checkbox"/> RR-4GT24	<input type="checkbox"/> RR-2GT36	<input type="checkbox"/> RR-GT48



Gas Type: Natural LP

Elevation (if above 2000 ft.): _____

Options and Accessories

- 6" high S/S stub back in lieu of high shelf
- 1" thick griddle plate
- Griddle on the right (Left hand side standard)
- Chrome griddle plate
- Grooved griddle (specify width: _____")
- One thermostat per burner (GT Griddle Series)
- One 26½" Convection Oven - add suffix "-126C"
Cabinet space: Left Right
- One standard 20" W Oven - add suffix "-120"
Cabinet space: Left Right
- One standard 26½" W Oven - add suffix "-126"
Cabinet space: Left Right
- 12" hot top section - add suffix "-HT"
- 9" deep S/S landing ledge, with or without sauce pan cutouts
- Additional oven racks
- Open cabinet base - add suffix "-XB"
- Cabinet doors
- Intermediate shelf
- Wok burner head with 10" diameter S/S ring
- 48" quick disconnect and restraining cable
- 5" swivel casters (set of four - 2 locking)

Standard Features

- Stainless steel drip tray/grease can
- Two 20" wide ovens
- Accommodates 18" x 26" full size sheet pan
- Stainless steel front, sides, valve cover and kick plate including backguard and high shelf
- Stainless Steel oven "U" burner rated at 27,000 BTU/hr
- Oven pilot with 100% safety shut down
- Two piece, heavy duty lift off cast iron burner heads rated at 30,000 BTU/hr
- 12" x 12" cast iron top grates with pilot shield
- Solid welded heavy gauge metal frame
- Five position heavy gauge chrome rack guides
- One chrome rack per oven
- Five surface porcelain oven interior
- Stainless steel tubing for burners and pilots
- 3/4" thick polished steel griddle plate
- GT Griddle Series - standard with one thermostat per two burners
- SU - step up rear burners
- RG - raised griddle/broiler



Royal Range of California, Inc.

3245 Corridor Dr. • Eastvale, CA 91752 • (800) 769-2414 • (951) 360-1600

Fax: (951) 360-7500 • www.royalranges.com • sales@royalranges.com



48" Gas Restaurant Range

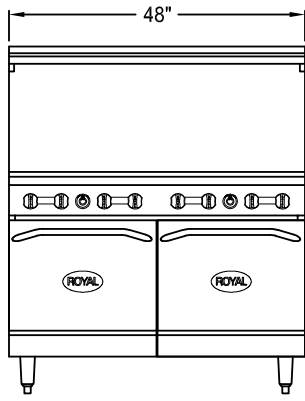

3/4" NPT Gas Inlet
2"

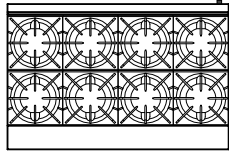

RR-8

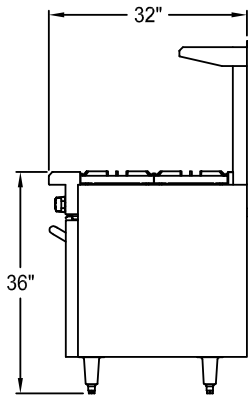

Standard Oven

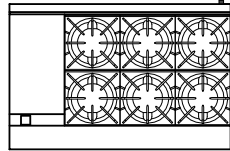

RR-6G12

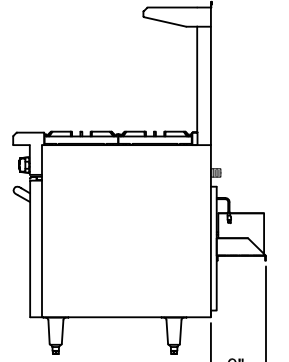

Convection Oven

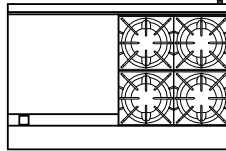

RR-4G24

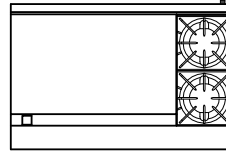

RR-2G36

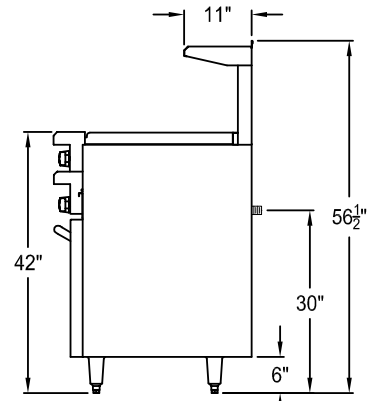

Raised Griddle

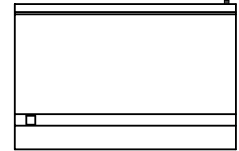

RR-G48

Model Number	Open Burners	Griddle Burners	Total BTU	Ship Weight
RR-8	8	0	294,000	800 lbs.
RR-6G(T)12	6	1	254,000	820 lbs.
RR-4G(T)24	4	2	214,000	830 lbs.
RR-2G(T)36	2	3	174,000	850 lbs.
RR-G(T)48	0	4	134,000	870 lbs.
RR-4RG24	4	2	214,000	910 lbs.
RR-8SU	8	0	294,000	810 lbs.

Notes:

- For no oven (storage base) add suffix "-XB" and deduct 54,000 BTUs.
- For one 20" oven and open storage add suffix "-120" and deduct 27,000 BTUs.
- For single 26-1/2" standard oven and open storage add suffix "-126" and deduct 19,000 BTUs
- For single 26-1/2" Convection Oven add suffix "-126C" and deduct 24,000 BTUs.
- Open burners at 30,000 BTU/hr each.
- Griddle Burners: 1 per 12" at 20,000 BTU/hr each.
- Oven burners at 27,000 BTU/hr each.

Gas Connection:

3/4" NPT on the right hand rear of the appliance.
The pressure regulator (supplied) is to be connected by the installer.

Electrical Requirements:

Convection Oven: 120 V, 50/60hz, 1 Ph., 8 amps
Two speed motor (1725/1140 RPM) 1/2 HP.
Provided with 6' power cord fitted with a standard three prong grounded plug.

Gas Pressure:

5" W.C.	Natural Gas
10" W.C.	Propane

Clearances:

	Combustible	Non-Combustible
Rear	4"	0"
Sides	15"	0"

Specify type of gas and altitude, if over 2,000 feet, when ordering.

Due to continuing product development to ensure best possible performance, these specifications are subject to change without prior notification.

Royal Range of California, Inc.
3245 Corridor Dr. • Eastvale, CA 91752 • (800) 769-2414 • (951) 360-1600
Fax: (951) 360-7500 • www.royalranges.com • sales@royalranges.com