



Item: _____

Quantity: _____

Project: _____

Step Up Hot Plate

Step Up Hot Plate

Models: RHP-12-2SU RHP-24-4SU RHP -36-6SU RHP-48-8SU



Gas Type: Natural LP

Elevation (if above 2000 ft.): _____

Options and Accessories

- Wok Burner with 10" diameter S/S ring
- Add plate shelf with or without cutouts
- Stainless Steel Equipment Stand

Knock Down All Welded

Size

12" 24" 36" 48" 60" 72"

5" swivel casters (set of four - 2 locking)

5" swivel casters (set of six - 3 locking)
(60" and 72" models)

Standard Features

- 11" high, Low Profile
- Full width, removable stainless steel crumb pan for easy cleaning
- Rear burners elevated 4"
- Compact heavy gauge chassis for long life
- Stainless steel sides, valve cover and plate ledge for easy cleaning
- Double wall panels for cooler sides
- 30,000 BTU/hr cast iron burners featuring removable, non-clog lift off heads with flat top design
- Heavy cast iron 12" x 12" top grates with unique bowl design
- Protected standing pilots for instant ignition
- Manual control for each burner
- Stainless steel tubing for burners and pilots
- 4" high adjustable heavy duty legs included
- Two year limited warranty, parts and labor



Royal Range of California, Inc.
3245 Corridor Dr. • Eastvale, CA 91752 • (800) 769-2414 • (951) 360-1600
Fax: (951) 360-7500 • www.royalranges.com • sales@royalranges.com



Step Up Hot Plate

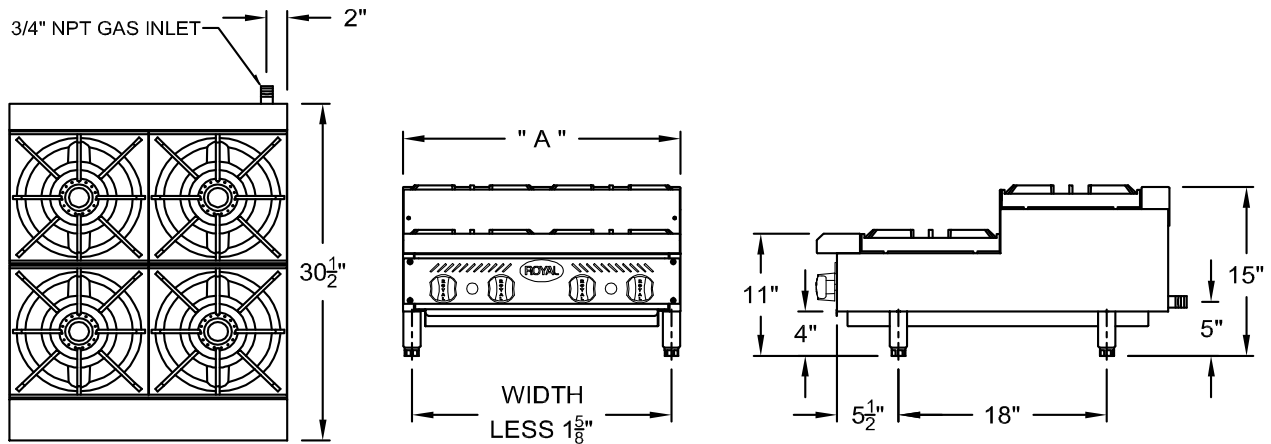

Model Number	Width (A)	Number of Burners	Total BTU	Ship Weight
RHP-12-2SU	12"	2	60,000	95 lbs.
RHP-24-4SU	24"	4	120,000	155 lbs.
RHP-36-6SU	36"	6	180,000	215 lbs.
RHP-48-8SU	48"	8	240,000	280 lbs.

Gas Connection:

3/4" NPT on the right hand rear of the appliance.

The pressure regulator (supplied) is to be connected by the installer.

Gas Pressure:

5" W.C.	Natural Gas
10" W.C.	Propane

Clearances:

	Combustible	Non-Combustible
Rear	4"	0"
Sides	15"	0"

Specify type of gas and altitude, if over 2,000 feet, when ordering.

Due to continuing product development to ensure best possible performance, these specifications are subject to change without prior notification.

Royal Range of California, Inc.
 3245 Corridor Dr. • Eastvale, CA 91752 • (800) 769-2414 • (951) 360-1600
 Fax: (951) 360-7500 • www.royalranges.com • sales@royalranges.com