

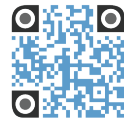

CRES36

Commercial Series Low-Profile Refrigerated Equipment Stand



CRES36
07/18/17
Item # 13386

W x D x H
36.5" x 33.25" x 26"*
*to work surface with 4" casters

Model CRES36



Dimensions / Capacity

One Section CRES36

Overall Width x Depth	36.5" x 33.25"
Height To Work Surface (including 4" casters)	26"
Depth with Drawer Fully Open (including 1.5" rear bumper)	55.75"
Pan Capacity (12" x 20")	2 (full), 2 (half long)
Maximum Pan Depth	6"
Worktop Maximum Load Capacity	700 lbs
Crated Shipping Weight	260 lbs
Crated Height x Width x Depth	28.75" x 38" x 34.5"

Electrical / Refrigeration

One Section CRES36

Voltage	115/60/1
HACR Breaker	15.0 Amps
Electrical Connection (NEMA)	5-15P
Voltage Range	104-126
Ambient Temp. Range	45° to 100°F
Control Setpoint Range	28° to 45°F
Amperage	3.7
Energy Consumption (kwh/day) @NSF	1.5
Heat Rejection (BTU/Hr.) @NSF	220
Approx. Nominal Compres. BTU/HR (HP)	1386 (1/5HP)
Refrigerant / Charge Amount (g) (oz)	R-134a / (242g) (8.5 oz)

Options

- HS-4007 - Drawer divider bars
- HS-5180 - Condenser Filter

Warranty

* 3 Year - parts and Labor on entire machine.
5 Year - Parts on Compressor
Valid in United States, Canada, Puerto Rico and U.S. Territories. Contact factory for warranty in other countries.

Item #: _____
Project: _____
Qty: _____
AIA#: _____

Features

- ▶ Heavy duty 16 gauge stainless steel top with marine edge (front/rear), drip edge (sides)
- ▶ Ceramic heat shield integral to top protects food from high heat
- ▶ 700 pound capacity provides sturdy base for cooking equipment

- Stainless steel exterior front, sides and top
- Stainless steel interior sides and back with stainless steel interior floor
- Solid state digital controller with temperature alarms and LED display (Fahrenheit or Celsius)
- Cabinet and drawers are insulated with 2" CFC free foamed in place polyurethane
- Stainless steel exterior drawer with stainless steel interior
- Drawer slides are constructed of 14 gauge stainless steel with acetal rollers and drawer stops
- Drawers will accommodate (1) 12" x 20" x 6" deep pans and (1) 1/2 long pan 6" deep (pans by others)
- Drawer frames are formed of 14 gauge stainless steel and securely fastened to cabinet
- Drawers are equipped with finger cut-outs for easy removal of pans
- Extruded aluminum flush mount drawer handles
- Magnetic drawer gasket is easily removable for cleaning
- Removable stainless steel end panel for access to refrigeration system
- Enamel coated evaporator coil
- Energy efficient automatic hot gas condensate evaporator
- Standard with (4) 4" casters all with brakes
- 8 ft. cord and plug



CRES36

Commercial Series Low-Profile Refrigerated Equipment Stand

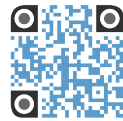

CRES36
07/18/17
Item # 13386

FRONT VIEW

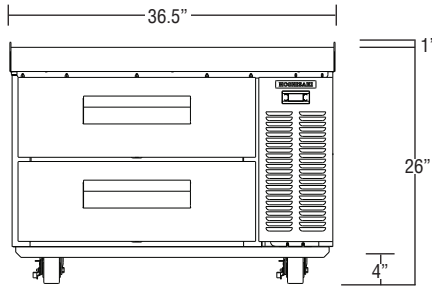

SIDE VIEW

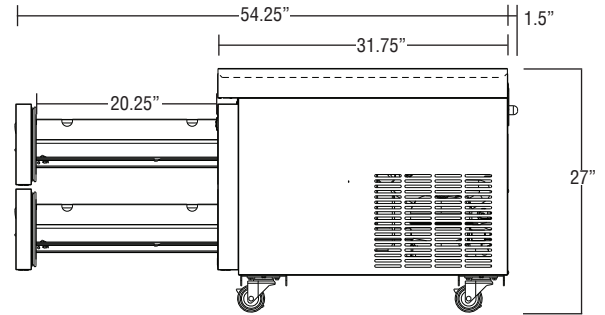

PLAN VIEW

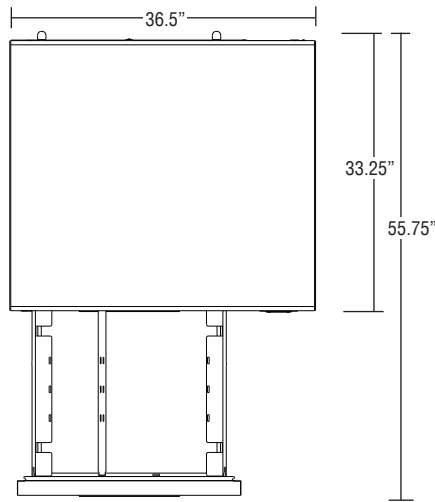

CLEARANCE

- Top: A minimum of 4" (11cm) clearance is required between the bottom of the cooking equipment heating element and the appliance top
- Sides: 1" (25mm) clearance
- Rear: The factory installed rear bumpers must be in place to ensure proper rear clearance.

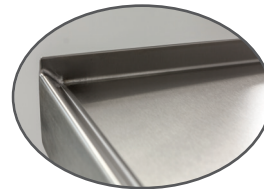

16 gauge stainless steel top with 1" drip edge

Cabinet Construction

The exterior cabinet front, sides, and top are constructed of high quality stainless steel. The exterior back and bottom are constructed of coated steel. The cabinet interior walls and ceiling are stainless steel. The floor is constructed of heavy gauge stainless steel with coved corner construction. Heavy duty ABS thermal breaks are used to reduce heat transfer in the frames. Cabinet walls and drawers are insulated with 2" of environmentally friendly R-134a, CFC free, foamed in place polyurethane. 4" heavy duty platform casters (all with brakes) are standard and installed at the factory.

Drawer Construction

Drawer fronts are constructed of high grade stainless steel with stainless steel interior and are insulated with R-134a CFC free foamed in place polyurethane. Each drawer accommodates (1) 12" X 20" X 6" deep pans and (1) 1/2 size long pan (pans by others). (Drawers will also accept 1/2, 1/3rd and 1/6th size pans with optional adapter bars). Drawer module frames are formed of 14 gauge stainless steel all welded construction and securely fastened in the cabinet. The drawer slides are constructed of heavy duty 14 gauge stainless steel with durable acetal rollers with stainless steel ball bearings to prevent metal to metal contact. The drawer slides have been life tested (fully loaded) three hundred thousand cycles without showing significant wear. The flush mount handles are constructed of extruded aluminum. Snap-in magnetic drawer gaskets are durable and easily removed for cleaning.

Refrigeration System

Solid state digital controller with temperature alarms maintains optimum cabinet temperature. A LED display shows the cabinet temperature and is adjustable to Fahrenheit or Celsius. The CRES36 has a front breathing refrigeration system. The high efficiency refrigeration system is standard with an enamel coated evaporator for extended life. Condensate removal is accomplished with an energy efficient hot gas condensate evaporator system. A capillary tube controls the flow of environmentally friendly R-134a refrigerant through the evaporator. Refrigeration system utilizes a heated defrost to eliminate any ice on the evaporator coil. 115 volt units are equipped with an eight foot cord and plug (20.0 amps or less).

Printed in the U.S.A.