

NEW Pro4-R **BIG**

BRAKE KIT

Professional Grade Race Brakes at Affordable Club Racing Prices. From Performance Street & Track Days to Club and Pro Racing.

Applications:

- | 96-04 Mustang
 - GT, V6, Cobra
- | 05-14 Mustang
 - GT, V6, GT500, Boss

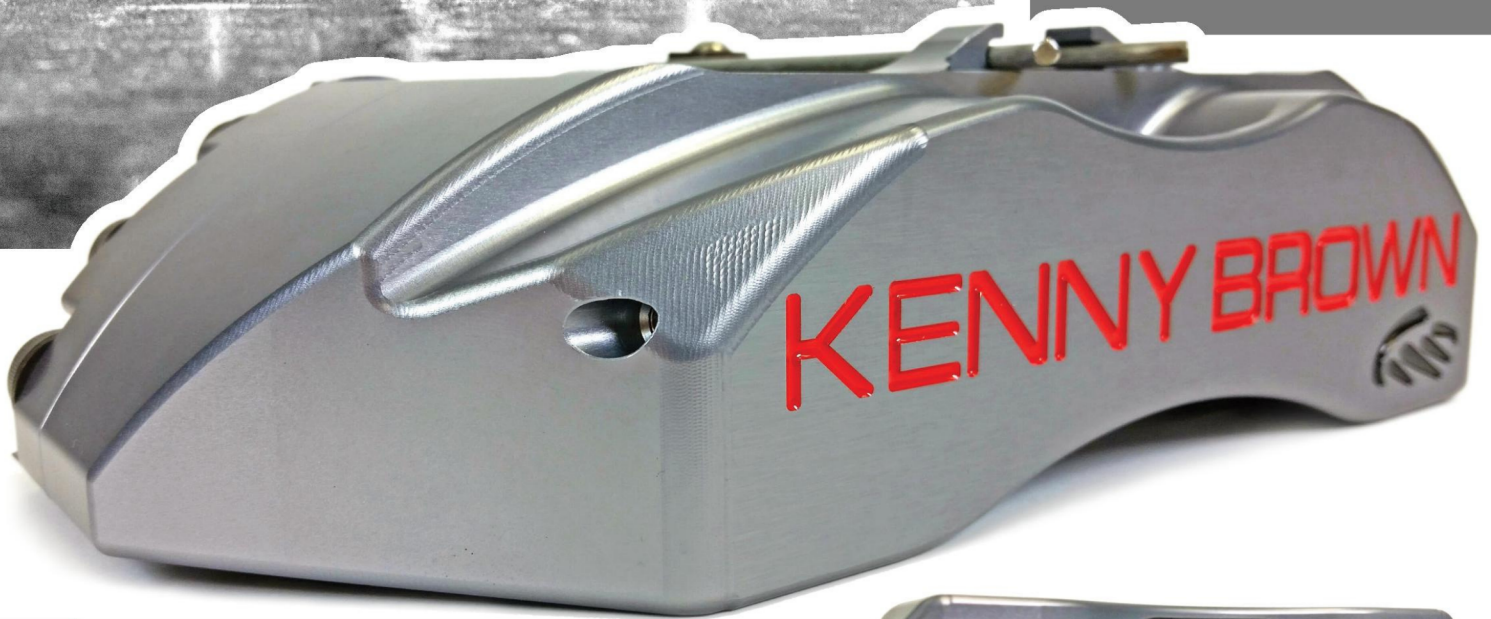

- | Performance Street | Autocross
- | Track Days | Club and Professional Racing

MATCH
made on
PAVEMENT

KENNY BROWN
PERFORMANCE

BAER
BRAKE SYSTEMS

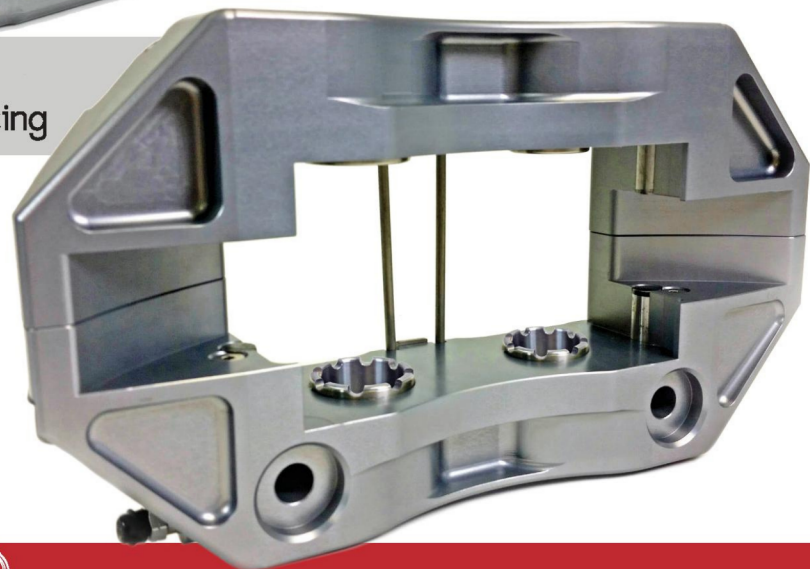

www.KennyBrown.com | 317.396.2768

NEW

Pro4-R BIG

BRAKE KIT

KENNY BROWN PERFORMANCE

BAER BRAKE SYSTEMS

Features & Benefits

Calipers

Rotors

All Brackets and Hardware Included

4-piston design saves weight and costs less

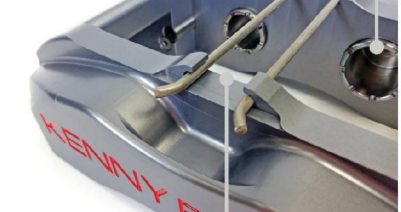

Top-loading for quick pad change

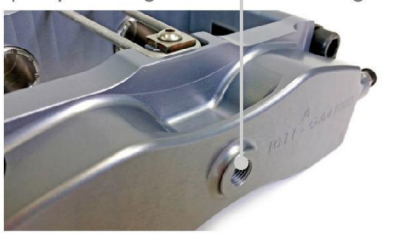

(6) 7/16" Holo-Krome USA made, certified hardware bolts hold the caliper together for extreme rigidity



Pocket machining for added weight savings without losing rigidity



Stainless pad abutment, so the pads do not ride/wear on the body of the caliper

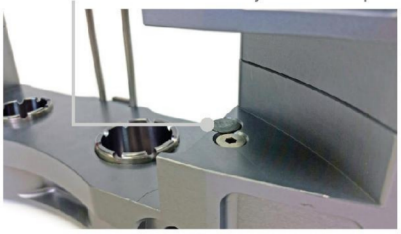

HD 14"x1.25" slotted cooling vane rotors



- | 4-piston competition design
- | 1.75 and 1.375 pistons matched to your master cylinder, no master cylinder upgrade required
- | Thick stainless steel notched piston reduces heat transfer into caliper
- | Uses the BIG 6-piston 25mm (.980 in) thick pads for better longer life and better stopping power. Pads sold separately, several compounds to choose from for your application.
- | Fully machined aluminum 2-piece caliper
- | Strong machined aluminum anodized radial mount brackets
- | Pocket machined for additional weight reduction
- | Holo-Krome USA made certified hardware
 - (6) Massive 7/16" caliper clamping cross bolts for maximum stiffness
- | ARP radial studs with ARP 12 pt nuts for super strength
- | Top-loaded pad design for quick and easy pad replacement
- | Machined banjo inlet design into caliper for no pipe thread fittings
- | Stainless steel braided brake hoses with proper banjo ends

- | HD 14"x1.25" directionally vaned slotted rotors
- | 6061 T-6 machined aluminum hats anodized black
- | Full floating rotor design with Bellville washers limiting noise

Takes big 6-piston brake pads for more grip (pads not included)
Pad thickness 25mm (.980") - almost 1" for longer pad life

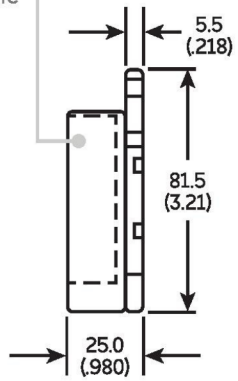
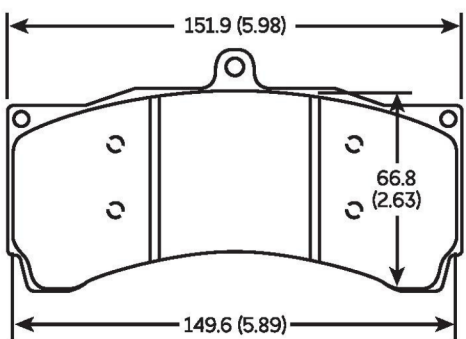

ARP hardware: radial studs, washers and 12pt nuts

Machined aluminum black anodized 6061 T-6 Radial bracket

Deep, thick wall, notched stainless pistons

Stainless braided brake hoses



Pro4-R BIG BRAKE KIT

96-04 SN95 Mustang: Front Pro4-R #146.523

05-14 S197 Mustang: Front Pro4-R #151.523

MATCH
made on
PAVEMENT

KENNY BROWN PERFORMANCE
BAER BRAKE SYSTEMS

Kenny Brown and Baer Brakes have teamed up to bring you their BEST Professional Grade Race Brakes at Club Racing prices for Performance Street, Autocross, Track Days, Club and Pro Racing. For the past 30 years, Kenny Brown has been tuning and building renowned high-performance, track and race Mustangs. Since 1994, Baer has been engineering and manufacturing the best-performing most complete brake solutions on the market.

