

# BLISS BB-2000

## USER MANUAL

BIOBIDET®  
BY BEMIS





**Questions?  
We're here to help.**

847.458.2334  
support@biobidet.com  
www.biobidet.com

Technical support and alternate  
fittings are available.

**04** **PRODUCT INFORMATION**

Important Safeguards  
Overview & Parts  
Wireless Remote

**10** **GETTING STARTED**

Functions & Features

**14** **INSTALLATION**

Installation Guide

**18** **MAINTENANCE**

Cleaning Tips  
Removing The Nozzle Tip  
Removing The BB-2000  
Draining The Warm Water Tank  
Troubleshooting Guide  
LED Flashing Troubleshooting  
Specifications

**25** **WARRANTY**

Warranty  
Customer Support  
Notes

## PLEASE OBSERVE THE FOLLOWING PRECAUTIONS AND INSTRUCTIONS BEFORE INSTALLATION AND USE.

- This product must be connected to a grounded 120V GFCI (Ground Fault Circuit Interrupt) outlet. Do not connect the power cord if it is damaged or broken. Do not plug the product into a loose electric outlet.
  - It is recommended to operate this product on a separate circuit. Sharing a circuit could cause the breaker to trip or lights to flicker.
  - If it is necessary to use an extension cord, use only a three-prong extension cord plugged into a proper GFCI outlet. The marked rating of the extension cord should be equal to or greater than the electrical rating of the unit (10 amp). Consult a qualified electrician or service person if you are not sure whether the unit is properly grounded.
- Do not open this product for repair without authorization from the manufacturer. Only qualified service personnel should service this product. Do not use accessories not recommended by the manufacturer.
- Connect this product to a potable cold water supply line.
- Close supervision is necessary when this product is used by children, elderly, or adults with sensitive skin. A low temperature burn may occur when the skin has been in contact with an object at relatively low temperature for an extended period of time.
- If using any chemical toilet bowl cleaner, be sure to wipe up any spills that splash onto the bidet. Do not use benzene or any acid chemical detergent, as they can cause discoloration. Only neutral detergents are permitted.
- Do not plug in the power cord before connecting the water supply hose.
- Install in an area with adequate ventilation to avoid high levels of humidity which can damage the electronic components.
- Do not touch the power cord with wet hands or reach for a product that has fallen into water. Unplug immediately.
- Unplug the bidet seat when cleaning or detaching from the toilet bowl. Do not plug in until plumbing work has been completed.
- Keep the power cord away from heated surfaces to prevent a fire hazard. Keep any flammable materials away from this product at all times.

WATER DOES IT BETTER.®

# OVERVIEW & PARTS

## BB-2000

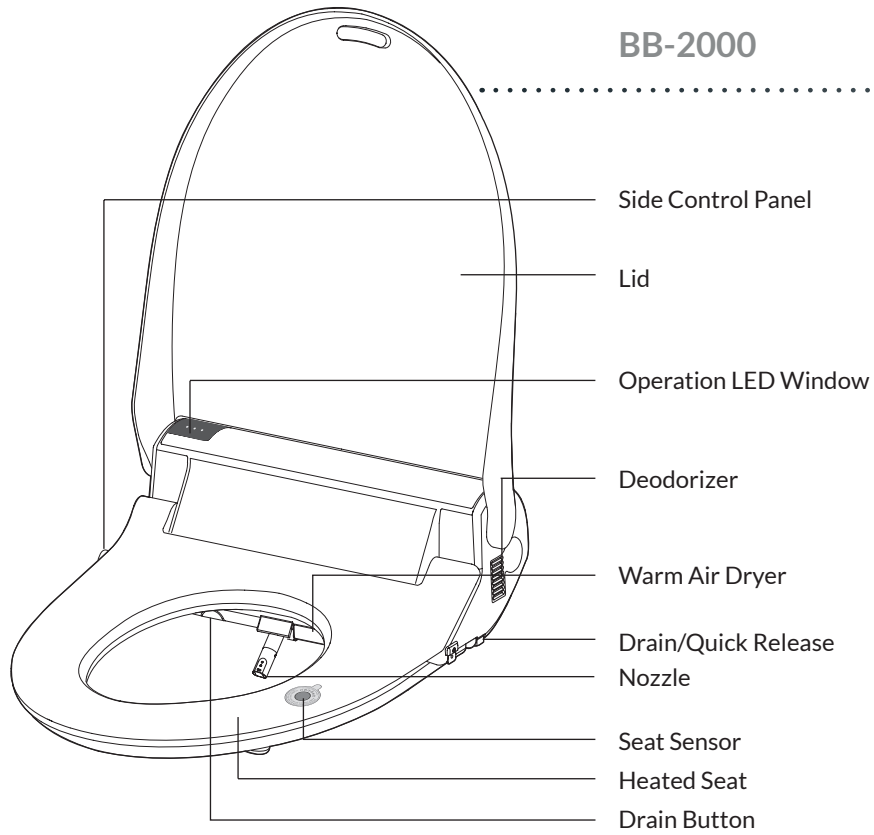

### Side Control Panel

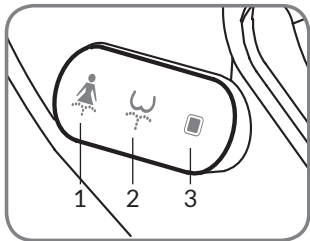

1. Front Wash
2. Rear Wash
3. Stop Button

### Stainless Steel Nozzle

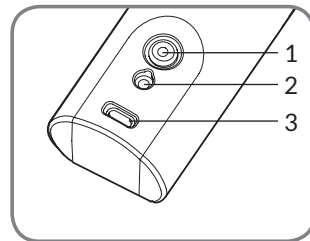

1. Vortex Wash
2. Rear Wash
3. Front Wash

## BB-2000 Parts List

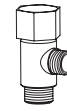

T-Valve

\*Rubber washer inside



L-Valve

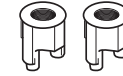

(2) Nuts



1/2 Conversion Nut

\*Rubber washer inside



(2) Cone Packings

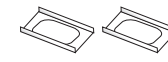

(2) Bolt Guides

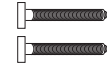

(2) Mounting Bolts

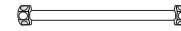

Bidet Hose



Toilet Hose

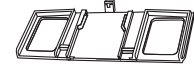

Catch Plate



Remote Control



Remote Control Bracket



(2) AAA Batteries















### Recommended Installation Tools



Wrench



Phillips Screwdriver

-  Stop Button
-  Rear Wash
-  Front Wash
-  Warm Air Dryer
-  Vortex Wash
-  Nozzle Oscillation
-  Massage/Auto Wash
-  Deodorizer
-  Adjustable Water Temperature
-  Adjustable Seat Temperature
-  Adjustable Nozzle Position
-  Adjustable Water Pressure
-  \*Set Time
-  Eco-Mode
-  Battery Life



\*Adjust the time with the "hour" and "minute" buttons.

## Remote Display

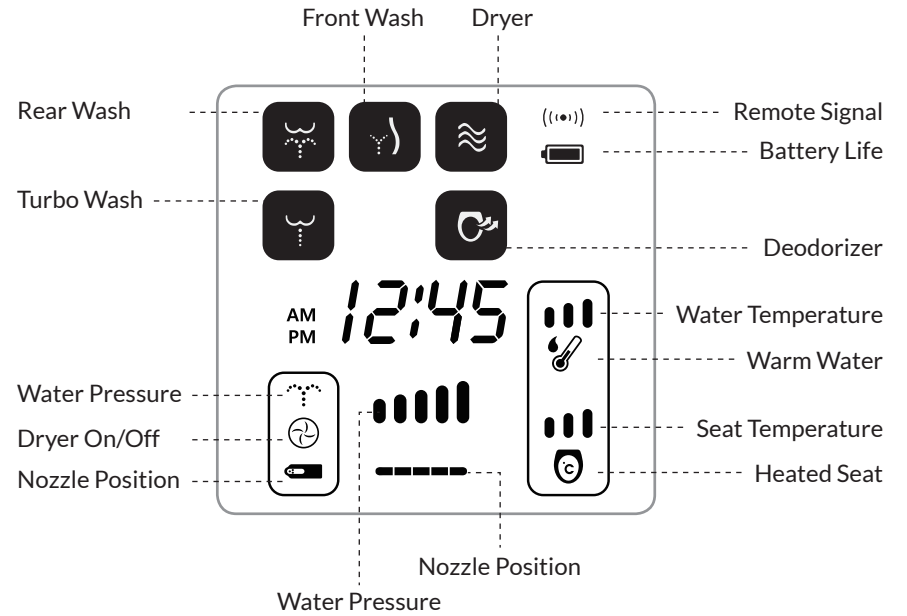

## Side Control Panel

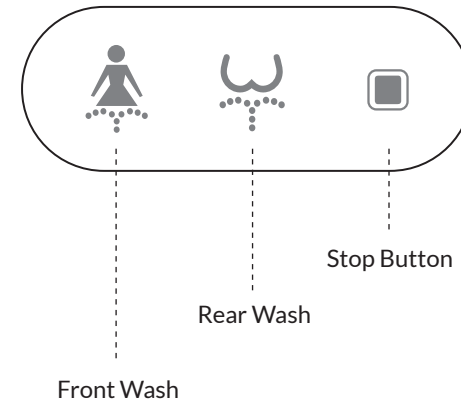

## Functions & Features

The Bliss BB-2000 is a bidet toilet seat designed for superior hygiene, comfort, and sustainability. Each use will leave you feeling clean and confident, while reducing your overall footprint.

### Sit Down On The Seat

This product includes a built-in seat sensor that must be activated with skin contact in order to operate bidet functions.

When you sit down on the seat and activate the seat sensor, the corresponding LED will light up on the main unit and the deodorizer fan will start.



### Stop Button

Stops all operations.



### Rear Wash

Press to activate the rear wash cycle, carefully crafted with the optimum cleansing angle and spray pattern.



### Front Wash

Press to activate the front wash cycle, which offers an alternate accommodating spray pattern.



### Vortex Wash

Press to activate a focused wash with higher water pressure.



### Massage

Press “Massage” during a wash cycle to activate a pulsating spray pattern. Change the water pressure with the “High” or “Low” (+, -) buttons.

**Automatic Massage Feature** - You can set this function to automatically pulsate whenever the seat is occupied and the Rear or Front washes are in operation. Press the “Massage” button for 3 seconds until you hear a chime. Proceed with a Rear or Front Wash. To cancel, press the button again for 3 seconds.



### Warm Air Dryer

Press to activate the warm air dryer. The dryer will automatically operate for 3 minutes.



### Adjustable Water Pressure

Press “High” or “Low” (+, -) to adjust the pressure of the water spray to your desired comfort level.

### Adjustable Water & Seat Temperature

Adjust the water and seat temperature by pressing the corresponding button to cycle through preset temperature levels.



Water Temp.



Seat Temp.



### Night Light

Press the “Stop” and “Water Temperature” buttons simultaneously to turn the night light on/off.





## Deodorizer

Press to turn the deodorizer on/off. When turned on, the deodorizer will automatically activate when seated to reduce odors, and remains active for 1 minute after standing up.

- Single short beep - Deodorizer **enabled**
- Double short beep - Deodorizer **disabled**



## Nozzle Oscillation

Press during a wash cycle to move the nozzle back and forth for a wider cleaning experience. Change the nozzle position by pressing “Nozzle Oscillation” and the “Front” or “Rear” (<, >) buttons.

**Automatic Oscillation Feature** - You can set this function to automatically oscillate when a wash is activated. Sit down and press the “Nozzle Oscillation” button for 3 seconds until you hear a chime. Proceed with Rear or Front Wash. To cancel, press the button again for 3 seconds. Make sure the seat sensor is activated during this time.



## Adjustable Nozzle Position

Adjust the nozzle position forward or backward to achieve maximum cleanliness and comfort by pressing the “Front” or “Rear” (<, >) buttons.



## Auto Wash

Select the “Auto” function to activate a pre-programmed wash and dry cycle.

- Wash (30 Seconds) + Dryer (1 minute)



## Energy Saving Mode

Switch energy saving features on/off. Energy saver mode automatically maintains the water and seat temperature at 89.6°F (32°C) while the seat is not occupied.

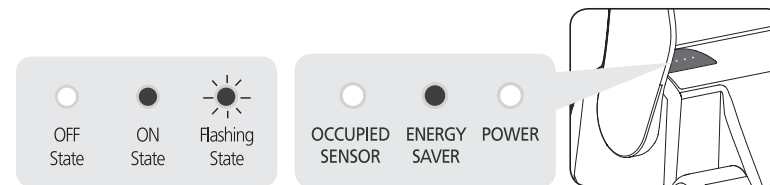

## OTHER ENERGY SAVING TIPS

- Keep the lid closed when not in use to prevent heat from being lost.
- Keep temperature set to low.
- Unplug the power cord if you do not plan to use the unit for an extended period of time.

## Silent Mode

- Beeping can be enabled or disabled by pressing and holding the “Stop” and “Massage/Auto Wash” buttons simultaneously for 3 seconds until you hear beeping.
- Single short beep - Silent mode has been **disabled**  
Double short beeps - Silent mode has been **enabled**
- The new setting will automatically be saved if no other buttons are pressed.

## Nozzle Cleaning

**Automatic** - This product has an automatic nozzle cleaning function that rinses the nozzle before each use.

**Manual** - Press and hold the “Rear Wash” button on the side panel without occupying seat for 3 seconds. The nozzle will fully extend without spraying. Gently clean the nozzle with a soft cloth or toothbrush. Press the “Stop” button to retract nozzle.

## BEFORE INSTALLATION

Do not plug the power cord in until installation is complete.

Please contact our service center at 847.458.2334 for alternate fittings or assistance with this process.

### 1. Turn Off Water

Turn off the water shut-off valve. Drain the toilet tank completely by flushing the toilet. Unscrew the hose connected to the toilet tank.

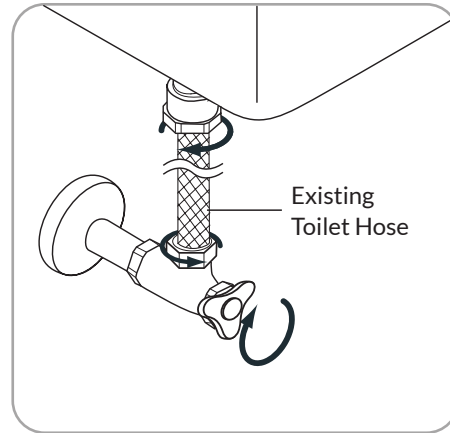

### 2. Remove Toilet Seat

Remove mounting bolts to release the existing toilet seat from the toilet.



### 3. Install Catch Plate

Place the catch plate and bolt guides over the mounting holes. Insert the mounting bolts through the guides, catch plate, and mounting holes. Slide the cone packing onto the bolts and fasten to secure the catch plate on the toilet.

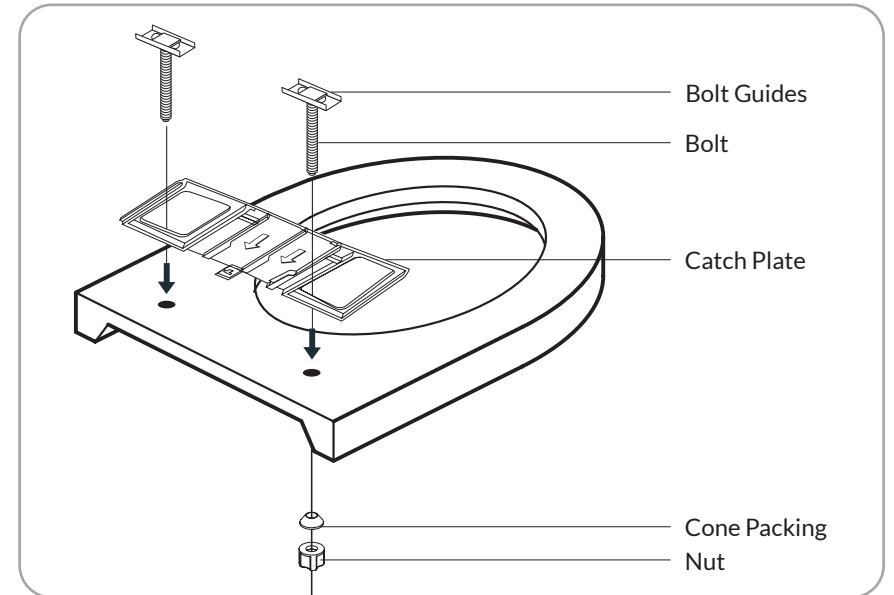

### 4. Install Your BB-2000

Slide the bidet seat all the way onto the catch plate until you hear a click.

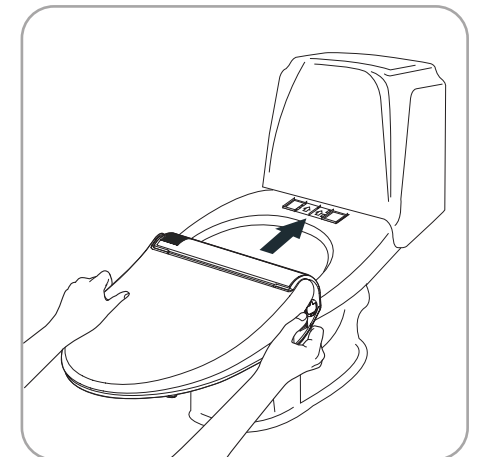



## 5. Connect the Water Hoses

- Install the t-valve onto the toilet tank. Ensure the rubber gasket is properly seated inside the t-valve.
- Connect the provided toilet hose to the water shut-off valve and t-valve. You may also use your existing toilet hose.
- Connect the bidet hose to the bidet seat and l-valve.
- Open the water shut-off valve. Check for any leaking or dripping. Use a wrench to tighten any loose connections.

**Shut-off valves may vary. If supplied parts do not fit, please call 847.458.2334. Alternate fittings may be available upon request.**

## 6. Plug It In!

Plug the power cord into a dedicated 120V power outlet.

## 7. Mounting the Remote

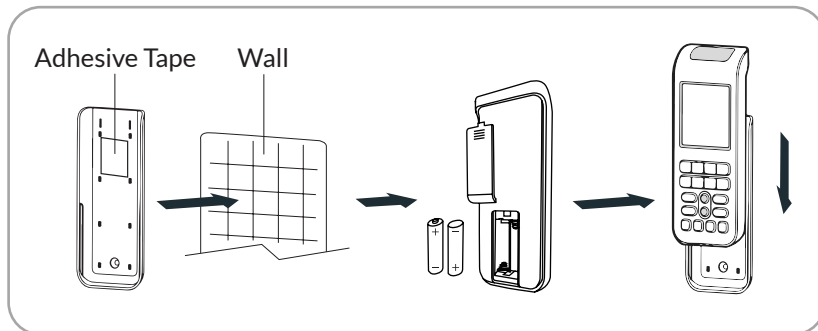

- Remove the adhesive cover from the back of bracket and place the bracket where desired.
- Insert the supplied batteries (AAA) and close the battery cover. Ensure the batteries are inserted properly accordingly to polarity.

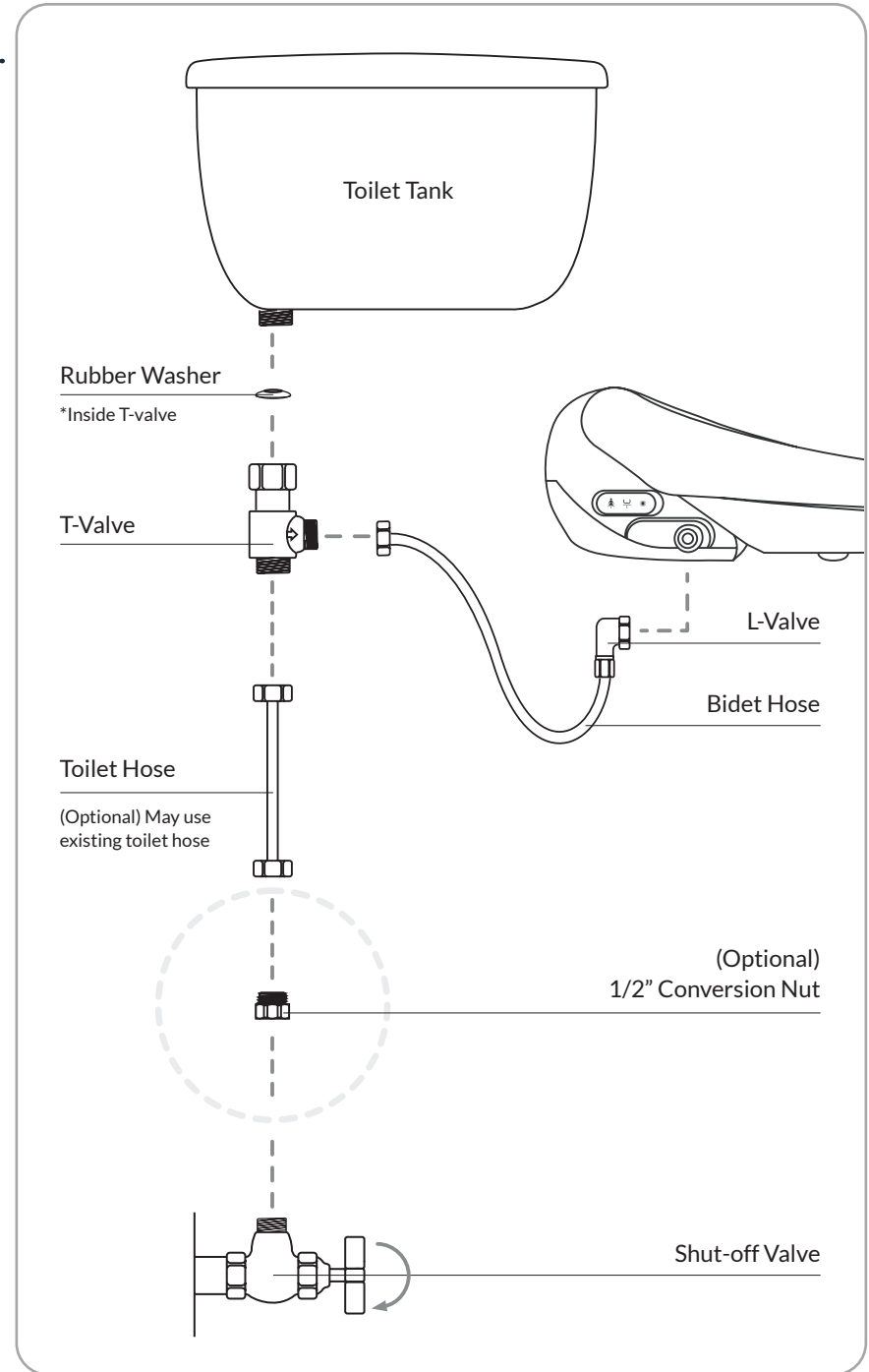

### Cleaning the Nozzle

Hold the “Rear Wash” button on the side panel for 3 seconds without occupying the seat to extend the nozzle for manual cleaning.

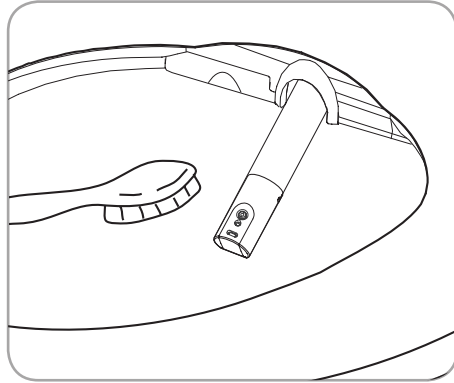

After cleaning the nozzle, push the “Stop” button and the nozzle will retract.

### Cleaning the Strainer

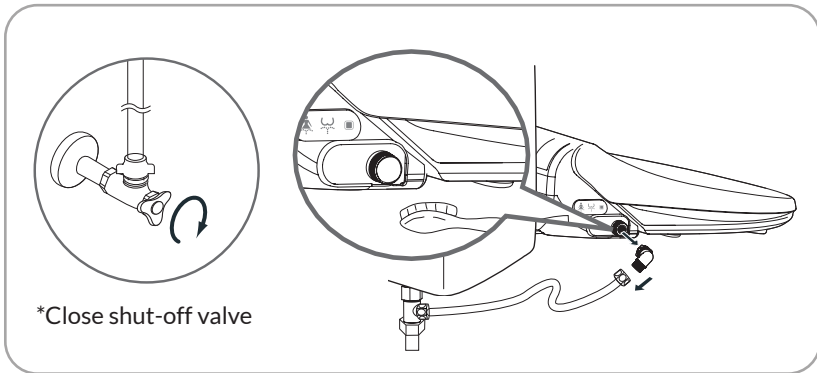

This product will not operate properly if the strainer is clogged. Please clean the strainer regularly.

1. Unplug the power cord.
2. Close the water shut-off valve.
3. Unscrew the bidet hose from the bidet seat.
4. Clean the strainer with a small brush.
5. Re-connect the bidet hose.
6. Open the water shut-off valve.
7. Plug in the power cord.

### Cleaning the BB-2000

- When you clean this product, do not use thinner, benzene or toilet bowl cleaner, as it may cause discoloration or damage.
- Disconnect the power cord and use a wet cloth when you clean this product.

### Water Filter Maintenance

- Use of external water filters is only recommended in areas with known hard water issues. If a filter is used, it should be replaced every 3 months.
- This product is designed and intended for use exclusively with Bio Bidet Carbon & Iodine water filters. The purchase or use of any other water filter is not the responsibility of Bio Bidet Innovation LLC. As such, any use of non Carbon or Iodine water filters is prohibited and will void the warranty for those Bio Bidet products. Bio Bidet will not be responsible for any resulting damages or claims related to the misuse or distribution of non Bio Bidet Carbon & Iodine filters.

## Removing the Nozzle Tip

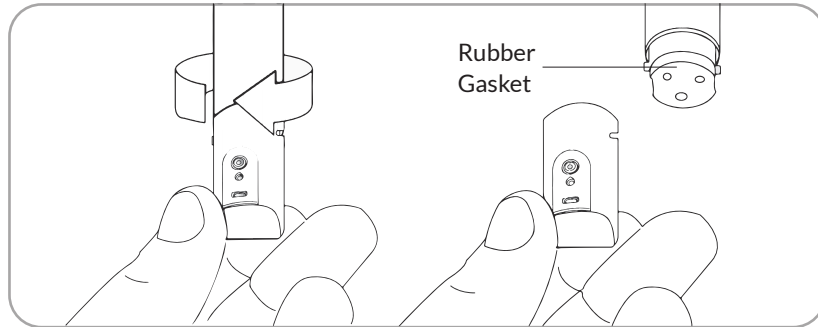

\*Be careful not to lose the rubber gasket located inside the nozzle tip.

Turn the nozzle tip counter clockwise to remove, or clockwise to secure it back in place.

## Removing the BB-2000

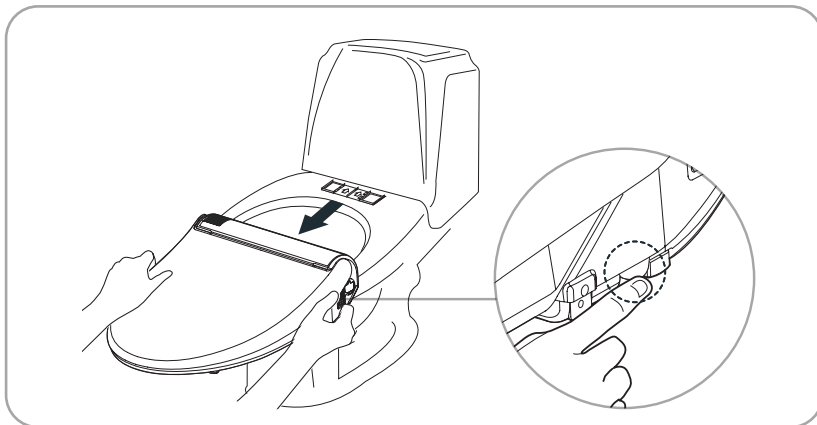

1. Disconnect the power plug.
2. Close the water supply shut-off valve.
3. Drain the water from the bidet by holding the drain button as shown above.
4. Remove the bidet seat from the toilet as illustrated.

## Draining the Warm Water Tank

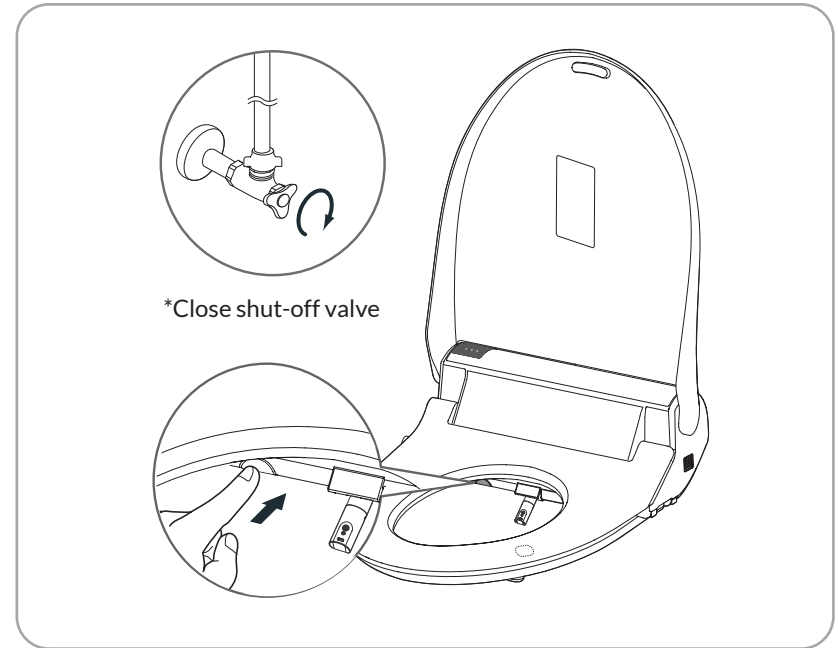

\*Close shut-off valve

Before draining, unplug the power cord and wait 30 minutes until the unit has cooled down. Do not insert your finger into the drain hole.

If you do not intend to use this product for an extended period of time, drain the water from this product's warm water tank.

1. Disconnect the power plug.
2. Close the water shut-off valve.
3. Press the drain button until the water is completely drained from water tank.

Open the water shut-off valve to refill and resume usage.

Problem	Cause	Solution
Water does not spray	<ul style="list-style-type: none"> <li>The water tank is not filled.</li> <li>The shut-off valve is closed.</li> </ul>	<ul style="list-style-type: none"> <li>Wait about one minute. Press the desired washing button once again.</li> <li>Open the shut-off valve</li> </ul>
The unit is not operating	<ul style="list-style-type: none"> <li>Disconnect the power cord.</li> <li>The seat is not occupied.</li> <li>Remote batteries are depleted.</li> </ul>	<ul style="list-style-type: none"> <li>Connect the power cord.</li> <li>Check the circuit breaker.</li> <li>Activate the seat sensor.</li> <li>Replace the batteries.</li> </ul>
Water is leaking	<ul style="list-style-type: none"> <li>Check the water connections.</li> </ul>	<ul style="list-style-type: none"> <li>Tighten the water connections. If water is still leaking from the main unit, call Bio Bidet customer support.</li> </ul>
The water pressure is weak	<ul style="list-style-type: none"> <li>The water pressure level is set to "Low".</li> <li>The strainer is clogged.</li> </ul>	<ul style="list-style-type: none"> <li>Set the water pressure to "High"</li> <li>Clean the strainer.</li> </ul>
The water is not warm	<ul style="list-style-type: none"> <li>The water temperature is set to "Low"</li> <li>Continuous operation has depleted the supply of warm water.</li> </ul>	<ul style="list-style-type: none"> <li>Set the water temperature to "High" and wait about 3 minutes.</li> </ul>
The seat and dryer are not warm	<ul style="list-style-type: none"> <li>The seat &amp; dryer temperature is set to "Low"</li> </ul>	<ul style="list-style-type: none"> <li>Set the seat &amp; dryer temperature to "High"</li> </ul>

## LED Light is Flashing

Count the blinking light sequence between each pause. If this chart applies to your BB-2000, you may need some replacement parts. Please contact our support team for further instructions on fixing your unit.

Light Type	# of Blinks	Problem & Solutions
Power Light	1	Incoming water temperature is too hot. Check the incoming water temperature.
	2	Discharge water temperature is too hot. Check the inlet for potential clogs.
	3 4	Water temperature malfunction. Unit will need to come into our service center for repair.
	5	Seat sensor malfunction. Send replacement seat to customer.
	6	Seat temperature is too high. Send replacement seat to customer.
	9	Dryer malfunction. Unit will need to come into our service center for repair.
Power Light + Economy LED Light	4	Water temperature malfunction. Unit will need to come into our service center for repair.
	1	
Power Light + Economy LED Light	3	PCB malfunction. Unit will need to come into our service center for repair.
	2	
Power Light + Economy LED Light	4	Water is leaking. Secure all connections. If leakage continues, unplug the power cord. Unit will need into come to our service center for repair.
	2	
Overall Beeping		Pump malfunction. Unit will need to come into our service center for repair.

Specifications		BB-2000
Power Rating		120Vac, 60Hz, 1400W
Water Inlet Pressure		0.04 ~ 0.74MPa (0.4 ~ 7.5 kgf/cm)
Power Cord		4 feet
Wash Device	Rear Wash	Max. 0.7l/min ( Max. 0.185 GPM )
	Front Wash	Max. 0.7l/min ( Max. 0.185 GPM )
	Adjustable Water Pressure	5 Levels
	Warm Water Temp	Room Temp - Low, Normal, High
Heated Seat	Temperature	Room Temp - Low, Normal, High
	Heater	55 W
Inlet Water Temperature		37.4°F ~ 95°F ( 3°C~ 35°C )
Ambient Temperature		37.4°F ~ 104°F ( 3°C~ 40°C )
Dimensions	Elongated	W: 15.43 in / L: 20.9 in / H: 5.98 in
	Round	W:15.43 in / L: 18.9 in / H: 5.71 in
Weight		10.5 lbs



**WARRANTY SUMMARY**



3 Year Full Warranty



At-Home Repair Instructions  
(Limited to certain products)



Service Center Repair Option\*  
*\*Warranty does not cover inbound shipping.*



Customer Support Available via Phone, Chat, & Email.

847.458.2334  
www.biobidet.com  
support@biobidet.com

**3 YEAR FULL WARRANTY**

Bio Bidet Innovation LLC warrants its product to be free from manufacturing defects under normal use and service for a period of three (3) years from original date of purchase.

This warranty is extended only to the ORIGINAL PURCHASER.

- Bio Bidet Innovation LLC’s obligations under this warranty are limited to repair or replacement, at Bio Bidet Innovation LLC’s option, of products or parts found to be defective, provided that such products were properly installed and used in accordance with instructions.
- Bio Bidet Innovation LLC reserves the right to make such inspections as may be necessary in order to determine the cause of the defect.
- Bio Bidet Innovation LLC will not charge for labor or parts in connection with authorized warranty repairs.
- Bio Bidet Innovation LLC is not responsible for the cost of removal, return, initial install, and/or re-installation of products.
- Bio Bidet Innovation LLC shall not be responsible or liable for any failure of, or damage to, this plumbing product or product component caused by either chloramines in the treatment of public water supply or in-tank bowl cleaners containing chlorine (calcium hypochlorite).

This warranty does not apply to the following items:

- Damage or loss sustained in a natural calamity such as fire, earthquake, flood, thunder electrical storm, etc.
- Damage or loss resulting from any unreasonable use, misuse, abuse, negligence, or improper maintenance of the product.
- Damage or loss resulting from removal, improper repair, or modification of the product.
- Damage or loss resulting from sediments or foreign matter contained in a water system.
- Damage or loss resulting from improper installation or from installation of a unit in a harsh and/or hazardous environment.

This warranty gives you specific legal rights. You may have other rights which vary from state to state. To obtain warranty repair service under this warranty, you must contact Bio Bidet Innovation LLC or an authorized distributor.

This written warranty is the only warranty made by Bio Bidet Innovation LLC. Repair or replacement as provided under this warranty shall be the exclusive remedy available to the purchaser. Bio Bidet Innovation LLC shall not be responsible for loss of the product or for other incidental, special or consequential damages or expenses incurred by the purchaser, or for labor or other costs due to installation or removal, or costs of repairs by others, or for any other expense not specifically stated above. Except to the extent prohibited by applicable law, any implied warranties, including that of merchantability or fitness for use, are expressly limited to the duration this warranty. Some states do not allow limitations on how long an implied warranty lasts, or the exclusion or limitation of incidental or consequential damages, so the above limitation and exclusion may not apply to you.

## BIO BIDET INNOVATION LLC

7900 S IL Route 31 Crystal Lake IL 60014  
T: 847.458.2334  
F: 847.854.1296

[support@biobidet.com](mailto:support@biobidet.com)  
[www.biobidet.com](http://www.biobidet.com)

## Notes

---

---

---

---

---

---

---

---

---

---

---

---

---

---

---

---

---

---

---

---

---

---

---

---

03.07.24

THANK YOU!

**BIOBIDET®**

*BY BEMIS*

**Customer Support**

T: 847.458.2334

TOLL-FREE: 877.339.5214

7900 S IL Route 31 Crystal Lake, IL 60014

[support@biobidet.com](mailto:support@biobidet.com)

[www.biobidet.com](http://www.biobidet.com)