



# SLIM ZERO

---

OWNER'S MANUAL

---





**PRODUCT INFORMATION**

Main Unit & Parts.....4  
Product Diagram.....5

**PRODUCT INSTALLATION**

Pre-Installation.....6  
Installation.....8  
Water Connection.....12  
Operation.....16  
Night Light Instructions.....17

**PRODUCT MAINTENANCE**

Cleaning & Maintenance.....20  
Troubleshooting.....22  
Specifications.....24

**WARRANTY**

Warranty.....26

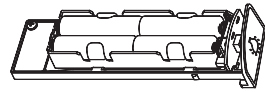
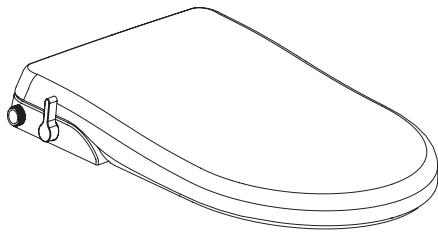

Battery Pack

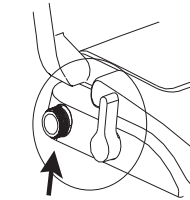

Metal water inlet on the left

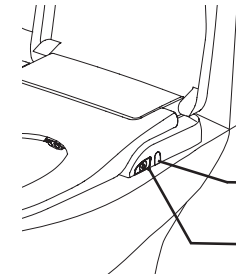

Seat release tab

Night Light Control and Battery Compartment

Method 1

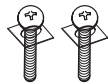

Metal mounting bolts (2)



Rubber expansion nuts (2)

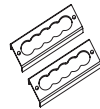

Mounting brackets (2)

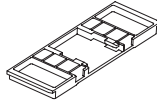

Catch plate

Method 2

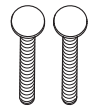

Plastic mounting bolts (2)



Butterfly Nut (2)

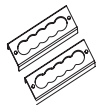

Mounting brackets (2)

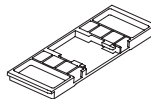

Catch plate

NOTE:

There are two methods for installation. The recommended way is using the rubber expansion nuts. The second option is using the butterfly nuts. Please select the option best suited for your specific installation needs.

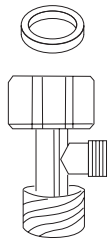

T-valve and rubber gasket

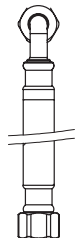

Bidet Supply Hose

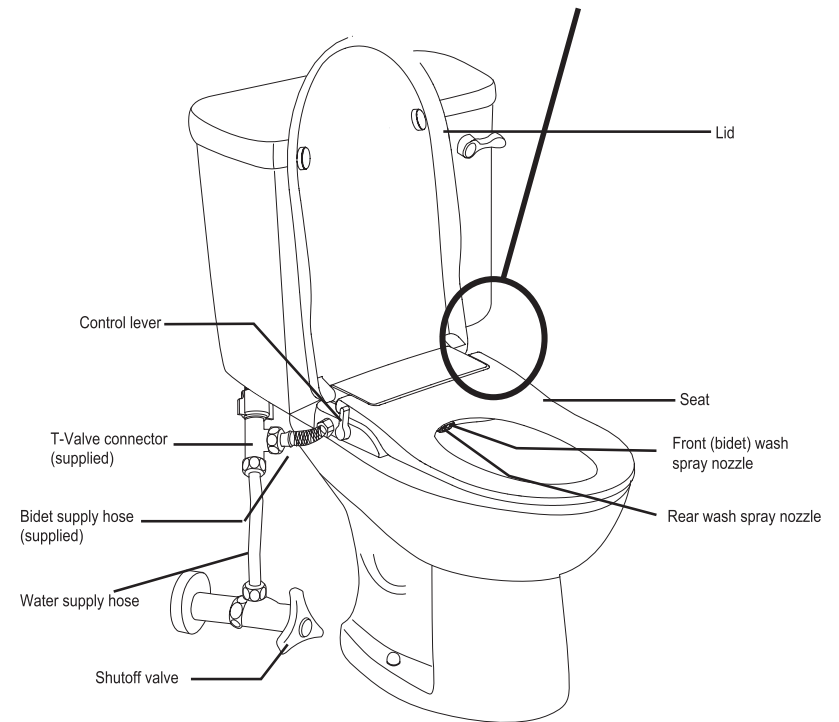



Please make sure you read the instructions carefully and install it properly.

## Caution

1. The water pressure limit is from 10 to 110 PSI. Please use as instructed.
2. The water shutoff valve should be near where the product is installed.

## Pre-Installation

1. Insert the mounting bolts into the rectangular steel mounting brackets.

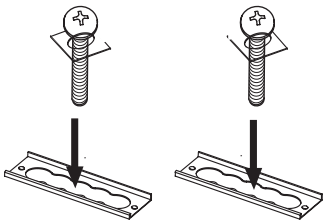

2. Insert the mounting bolts with the brackets into the catch plate.

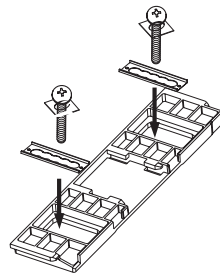

3. Example of how the bolts fit through the mounting brackets and how they are placed onto the catch plate and secured to the toilet.

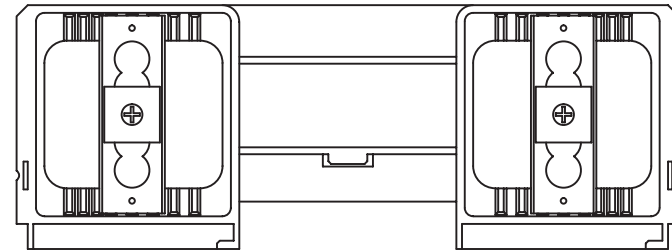



## First Installation Method (Recommended)

### 1. Completely remove the old toilet seat and lid.



### 2. Install expansion nuts.

- Be sure to firmly press down so the top of the expansion nut is flush with the ceramic toilet surface.



### 3. Attach the catch plate.

- Attach the catch plate in the toilet seat holes. Adjust the position of mounting bolts and adjust the pieces to line up the mounting bolts to the expansion nuts. Then tighten to secure the catch plate.

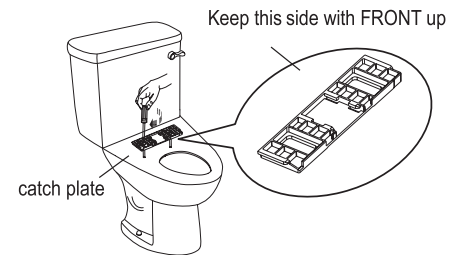

### 4. Install the bidet seat.

- Line up the bidet with the catch plate then push the bidet seat onto the catch plate. You will hear the bidet seat click into place.

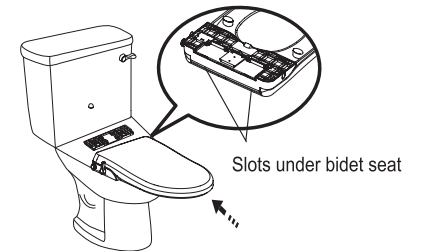



## Second Installation Method

### 1. Remove the old toilet seat.



### 2. Attach the catch plate.

- Put the catch plate over the toilet seat mounting holes. Screw on the nuts from underneath the toilet. Tighten to secure the catch plate.



### 3. Install the bidet seat, line up the bidet with the catch plate, you will hear the seat click into place.

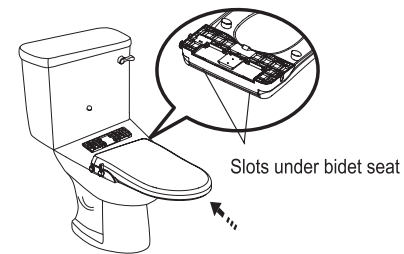



1. Close the water supply valve. Flush the toilet.

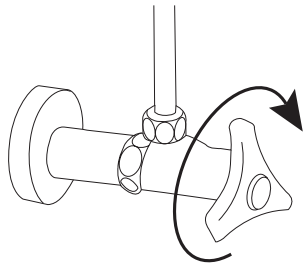

2. Unscrew the water supply hose from the water tank. Place a towel below the tank to catch any dripping water.

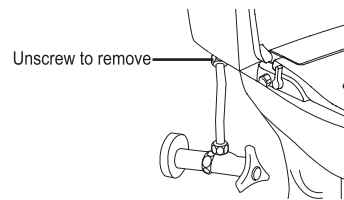

3. Attach the T-valve to the water tank where you removed the water supply hose. Ensure the rubber gasket is properly seated within the T-valve.

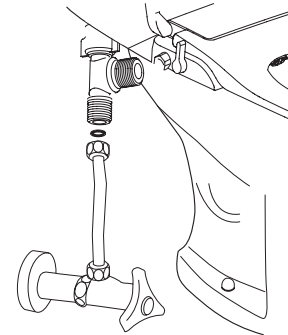

4. Re-attach the water supply hose to the bottom of the T-valve.

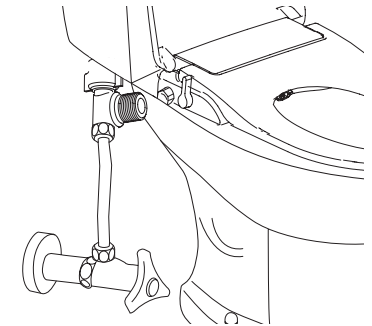



### 5. Connect the bidet supply hose.

- Connect the bidet supply hose to the metal inlet on the side of the bidet seat. Connect the other end of the hose to the T-valve and tighten snugly. Be careful not to over-tighten.

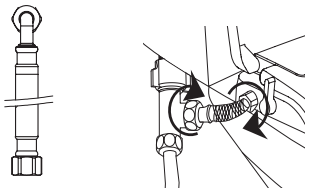

### 6. Slowly open the water valve to check if there is any leakage.

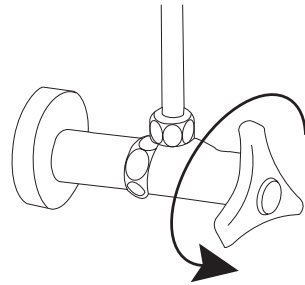

### 7. Wipe the hoses and connectors thoroughly with a towel and carefully observe for any leaks for at least 10 minutes.

- Tighten any connectors gently until leakage stops. If any leaks continue, turn off the water supply and check older hoses for damaged rubber o-rings. Teflon tape may be used on connections to help seal.





**Stop**

- Return the lever to the upright position to turn it off.

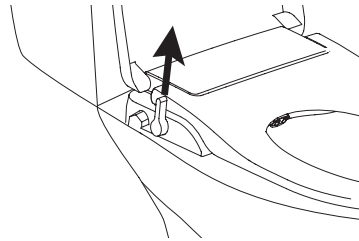

**Bidet (Front Feminine Wash)**

- Gradually push control lever forward until preferred pressure is reached.

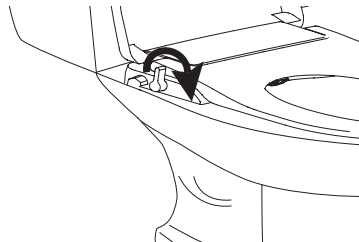

**Rear Wash**

- Gradually push the control lever back until preferred pressure is reached.

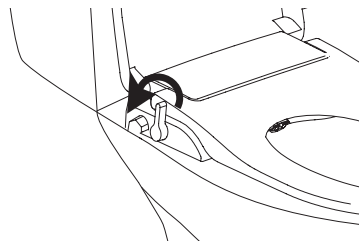

**1. Installing the battery**

- Remove the battery pack.
- Insert 4AA batteries, and put the battery pack in the control box. Replace the cover firmly.

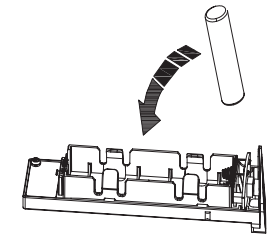
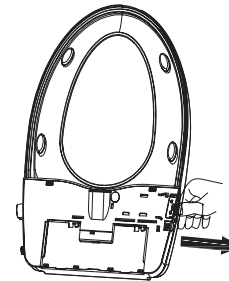

- To ensure the proper polarity AA batteries must be used.
- During initial installation and replacement of the batteries you must install based on the figure provided above.
- During long periods of non-use, it is recommended to remove the batteries from the battery pack.

**Note:** Please check and clean the battery contacts prior to installation  
Single use AA batteries are recommended.

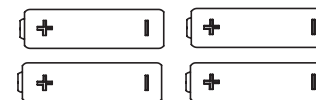
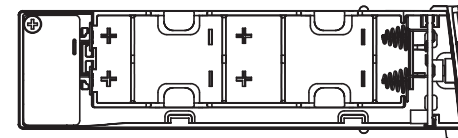



## 2. Instructions

- Install the bidet onto the toilet.

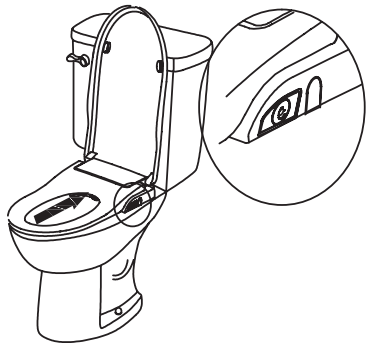

## 3. Replacing the battery.

- When the light turns red please replace the battery.
- When replacing the battery, press the release button on the bidet, then remove. Repeat the steps above to replace the batteries.



## Operation

- Press the button once, the high light is on.
- Press again, the low light is on.
- Press a third time, the light will turn off.

## Important

- To prolong the battery life, the night light turns off after 7 hours.
- Pressing the power button will reset the 7 hour timer.



## 1. Cleaning the exterior of the bidet seat.

- Using a sponge/cloth with water and/or mild soap to clean the product. Do not use the following types of cleaning products: hydrogen chloride detergent, paint thinner, benzene abrasive paper, polishing agent, bleach or chlorine.

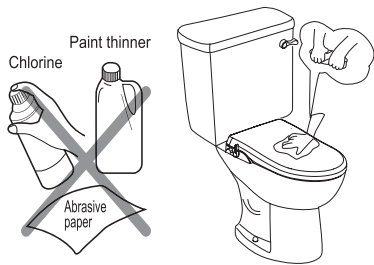

## 2. Cleaning the spray nozzles.

- Pull out the nozzle softly and use a smooth cloth/sponge or soft toothbrush to clean the nozzle.

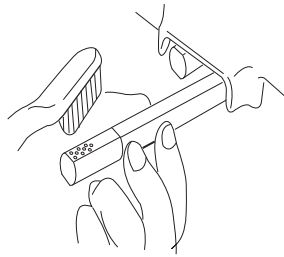

## 3. Clean the filter and regulator.

- Turn off the water supply, remove the white water hose and clean the filter screen.
- Clean the regulator o-ring.

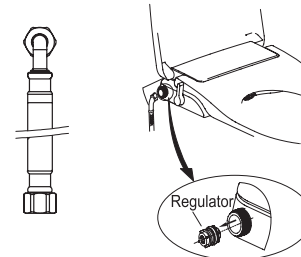

## 4. Remove the main body.

- Close the cover. Push and hold the release button and pull the bidet seat forward as shown.

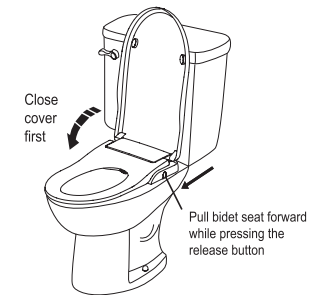



| Status  | Cause                                       | Solution   |
|---|---|--|
| Water is too low during WASH/BIDET                  | Low water pressure of the unit.             | During use, turn the lever forward or backward to highest setting  |
|   | Low water pressure of water supply.         | If the water supply pressure is too low, contact your local water utility.   |
| No water comes out during WASH/BIDET                | Water shut-off valve is turned off          | Turn on the water shut-off valve   |
|   | Filter of the T-shaped connector is clogged | Clean the filter of the T-shaped connector   |
|   | Filter of water inlet hose is clogged       | Clean the filter of water inlet hose   |
|   | Nozzle head is stuck                        | Take off and clean the nozzle head   |
|   | External water pressure is low              | Increase the external water pressure   |
| Water is dropping from the bowl when using the unit | External water pressure is too high         | The maximum water pressure of the unit is 110 PSI. If the water supply pressure is above this, contact your local water utility. |
| Night light doesn't work                            | Low batteries                               | Water is too low during WASH/BIDET   |

If any failure still occurs after above troubleshooting, please contact [support@biobidet.com](mailto:support@biobidet.com)



Do not disassemble, repair, or remodel the unit, as this will void the warranty.



| <b>Classifications</b> | <b>Description</b>                     |
|------------------------|--|
| Model Number           | Slim Zero                              |
| WASH water flow        | 0.35-1.8 L/min                         |
| Feminine water flow    | 0.35-1.8 L/min                         |
| Backflow Prevention    | Check valve                            |
| Water Supply           | Direct from water pipes                |
| Water Pressure Range   | 10-110 PSI                             |
| Dimensions             | 19.68" (l) x 14.30" (w)<br>x 2.25" (h) |
| Weight                 | 4.85 lbs                               |



Your Bio Bidet Slim Zero is warranted against defects in materials or workmanship for one (1) year from the date of original purchase. Defective parts or a defective product returned to Bio Bidet will be repaired with new or comparable rebuilt parts by Bio Bidet at their sole discretion.

This limited warranty given by BBC Innovation LLC covers all defects encountered in normal use of Bio Bidet Slim Zero, and does not apply in the following cases

1. Loss of or damage to Bio Bidet Slim Zero due to abuse, misuse, tampering, mishandling, improper packaging by you, alteration, and failure to following operating instructions.
2. Use of parts supplies (other than those by BBC Innovation LLC's dealers) that cause damage to Bio Bidet Slim Zero.
3. Replacement of discolored or stained parts caused by chlorine, bleach, ammonia and other chemicals, cleaning supplies, oxidation, normal wear and tear.
4. Damage to or malfunction of the unit as a result of improper and negligent installation.
5. Any and all damages to plumbing, walls, floors, ceiling and personal properties resulting from water leaks or breakage. The product must be used at the user's own risk. Therefore, the owner hereby releases the manufacturer and distributor from any and all claims for damages where the above condition exists.

No implied warranty, included any implied warranty of merchantability or fitness or a particular purpose, applies to Bio Bidet after the applicable period of the express limited warranty stated above, and no other express warranty or guarantee, except as mentioned above, given by any person or entity with respect to Bio Bidet shall bind Bio Bidet, (some states and provinces do not allow limitations of the length of an implied warranty) so the above limitation may not apply to you. Bio Bidet shall not be liable for revenues or spacings, inconvenience, expense for substitute equipment or service, or any other special incidental or consequential damages caused by the use or misuse of or in ability to use, Bio Bidet regardless of the possibility and foresee ability of such damages. In no event shall recovery of any kind against Bio Bidet be greater in amount than the purchase price of the product and causing the alleged damage. Without limiting the foregoing, you assume all risk and liability for loss, damage or injury to you and your property and to others ad their property arising out of use or misuse of or inability to use the Bio Bidet not caused directly by the negligence of Bio Bidet. This limited warranty shall not extend to anyone other than the original purchaser of the Bio Bidet.

# Thank You



Technical Support/Customer Service  
7900 S Route 31 Crystal Lake, IL 60014

T: 847.458.2334

U.S. TOLL FREE: 877.339.5214

[support@biobidet.com](mailto:support@biobidet.com)

[www.biobidet.com](http://www.biobidet.com)