



PRODIGY

INSTALLATION MANUAL





PRODUCT INSTALLATION

Before Installing.....4
Parts.....5
Installation.....6



Confirm the compatibility of your bathroom using the dimensions below:

- A. What is my rough-in?
12" from the wall to the center of the toilet trap.
- B. Where is my shutoff valve?

Type B1: The shutoff valve will be positioned outside of the toilet base if it is more than 6.25" from the center of the trap when measured along the wall.

Type B2: The shutoff valve will be positioned inside the toilet base if it is less than 5".

- C. Shutoff valve position If the shutoff valve is positioned between B1 and B2, it must have a depth of less than 4" to allow for proper installation.

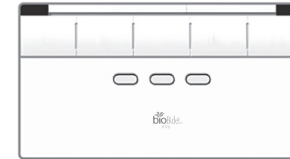
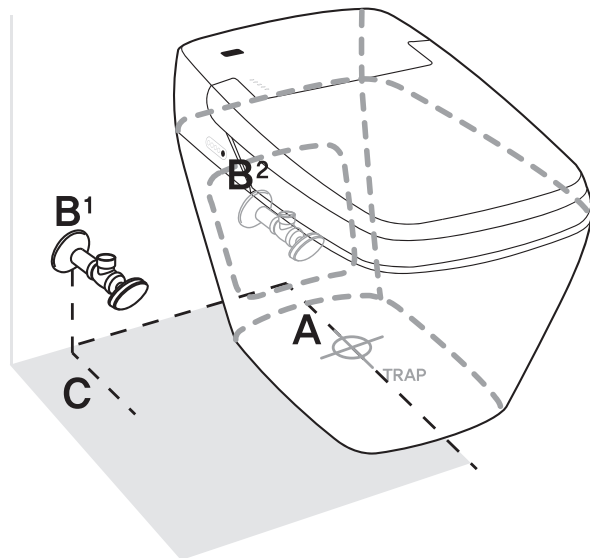

Remote control

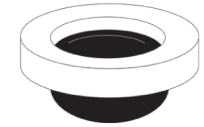

Wax Ring

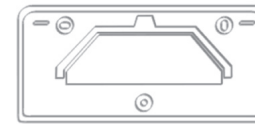

Wall Mount



Conversion Nut (optional)

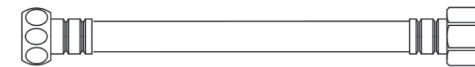

Hose



AA Batteries (x3)



Screws (x3)



Anchors (x3)



Remove the existing toilet

1. Close the water shutoff valve and flush the toilet.
2. Disconnect the existing water hose and unscrew the flange bolts.

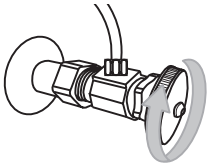

3. Remove the toilet and wax ring, leaving the exposed trap (pictured below).

*if you will not install the Prodigy immediately, cover the exposed trap to eliminate any fumes.

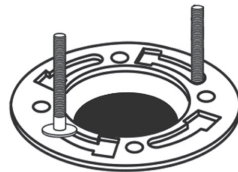

Install the Prodigy Base

1. Attach the provided water hose to your water shutoff valve.
2. Apply the new wax ring to the exposed trap.

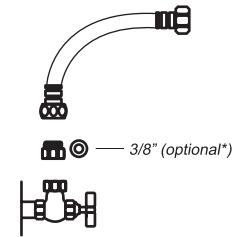

*You may need to use the included conversion nut to fit your water shutoff valve. Simply screw the conversion nut into the 1/2" side of the hose before connecting it to your water shutoff valve.

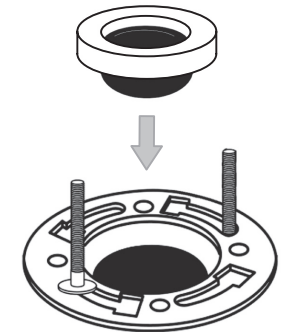

3. Line up the toilet base over the flange screws. Place the toilet base and re-secure the flange bolts.

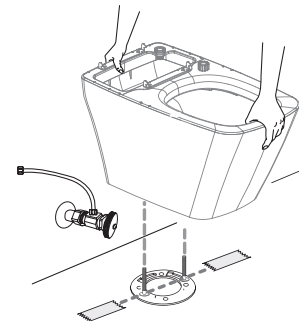

*A team of two people is recommended to correctly place the toilet base.

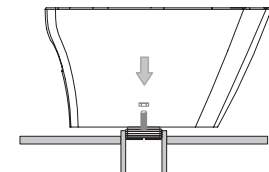



Attach Bidet Seat

1. Feed the water hose through the back of the toilet base and attach it to the underside of the bidet seat.

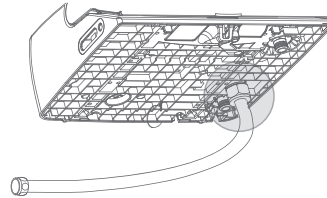

2. Attach the bidet seat to the toilet base by lining up the mounting hooks and pressing down until you hear a “click.”

Do not use excessive force when attaching the bidet seat to the toilet base.

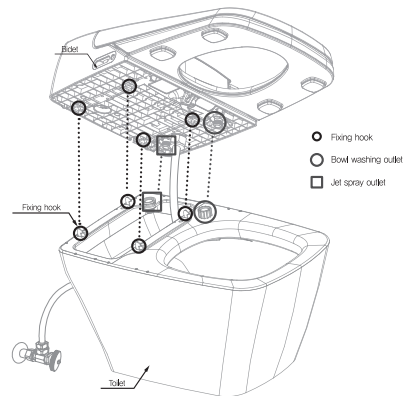

Removing The Bidet Seat

1. The bidet seat can be removed by pulling the tabs beneath the unit forward and lifting up.

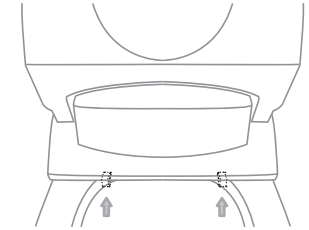



1. Open the water shutoff valve.

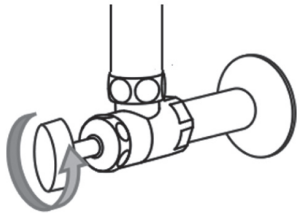

2. Plug in the power.

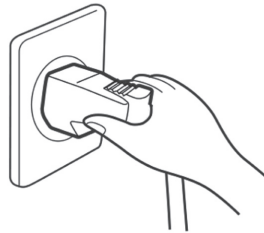

*The Prodigy must be plugged into a properly installed and grounded outlet.

Contact us

Please contact Bio Bidet support if you have any questions. Trained support agents are available Mon - Fri, 9:00 AM - 5:00 PM CST.

Email: support@biobidet.com

Phone: 847.458.2334

Chat: www.biobidet.com

3. Insert the included batteries into the remote control and flush the toilet.

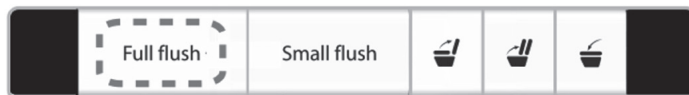

Thank You



Technical Support/Customer Service
7900 S Route 31 Crystal Lake, IL 60014

T: 847.458.2334

U.S. TOLL FREE: 877.339.5214

www.toiletseats.com

support@biobidet.com

www.biobidet.com