



# LW-1000

---

OWNER'S MANUAL

---





**PRODUCT INFORMATION**

Important Safeguards & Cautions.....4  
Cautions Before Installation.....6  
Main Unit & Parts.....8  
Remote Control.....10  
Dimensions.....11

**PRODUCT INSTALLATION**

Installation.....12

**PRODUCT OPERATION**

Operation.....16  
Maintenance & Cleaning.....24  
Settings.....26  
Specifications.....29

**WARRANTY**

Warranty.....30



**This unit was manufactured for household use only. Read all operating instructions before installation.**

## NOTES:

- This product should be installed according to this manual.
- Please read this manual carefully and install properly.
- Please save this manual and place at an easily accessible location.
- Do not attempt to service this appliance yourself. Doing so could void the warranty.

## IMPORTANT SAFEGUARDS

- When using electrical products, Basic electrical safety precautions should always be followed.

## READ ALL INSTRUCTIONS BEFORE USING

- For use with 120V 60Hz: Power supply must be a 15 Amp GFCI outlet.
- The electrical cord must be connected to a GFCI outlet.
- The GFCI outlet should be 1ft. above the floor.
- Install only in well-ventilated areas to avoid excess humidity.
- Do not install in narrow toilet stalls or in shower stalls.
- Install only where direct contact with water is minimized.
- Do not install near any heat source.
- Avoid using extension cords if possible. Consult with a certified electrician where extension cords are necessary.

## DANGER - To reduce the risk of electrocution:

- Do not use while bathing.
- Do not place or store product where it can fall or be pulled into a tub or sink.
- Do not place in or drop into water or other liquid.
- Do not reach for a product that has fallen into water. Unplug immediately.

## WARNING- To reduce the risk of burns, electrocution, fire, or injury to persons:

- Close supervision is necessary when this product is used by, on, or near children.
- Use this product only for its intended use as described in this manual. Only use attachments recommended by the manufacturer.
- Never operate this product if it has a damaged cord or plug, if it is not working properly, has been dropped or damaged, or dipped into water. Return the product to a service center for examination and repair.
- Keep the cord away from heated surfaces.
- Never drop or insert any object into any opening or hose.
- Do not use outdoors or operate where aerosol (spray) products are being used or where oxygen is being administered.
- Connect this product to a properly grounded outlet only. See grounding instructions.
- Unplug this product before filling. Fill (reservoir) with water only.

## SAVE THESE INSTRUCTIONS



## GROUNDING INSTRUCTIONS

**DANGER- Improper use of the grounding plug can result in a risk of electric shock.**

- This product has a three-prong grounding plug, which must be plugged into an outlet that is properly installed and grounded. In the event of an electrical short circuit, grounding reduces the risk of electric shock by providing an escape wire for the electric current. If repair or replacement of the cord or plug is necessary, do not connect the grounding wire to either flat blade terminal. The wire with insulation having an outer surface that is green with or without yellow stripes is the grounding wire. Check with a qualified electrician or serviceman if the grounding instructions are not completely understood, or if in doubt as to whether the product is properly grounded.
- This product is for use on a nominal 120V circuit, and has a grounding plug that looks like the plug illustrated in sketch A in Figure 1. A temporary adapter, which looks like the adapter illustrated in sketches B and C, may be used to connect this plug to a 2-pole receptacle as shown in sketch B if a properly grounded outlet is not available.
- The temporary adapter should be used only until a properly grounded outlet (sketch A) can be installed by a qualified electrician. The green colored rigid ear, lug, or the like extending from the adapter must be connected to a permanent ground such as a properly grounded outlet box cover. Whenever the adapter is used, it must be held in place by a screw.

Figure 1

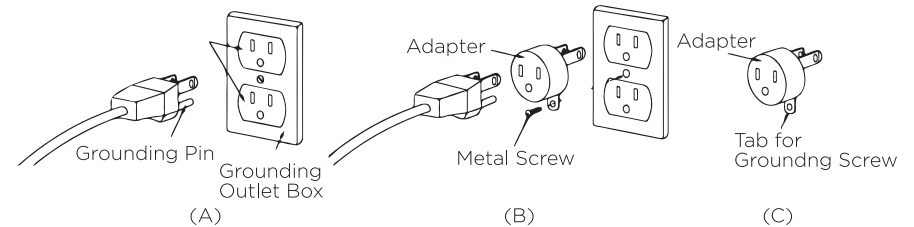

## Optional Grounding Instructions

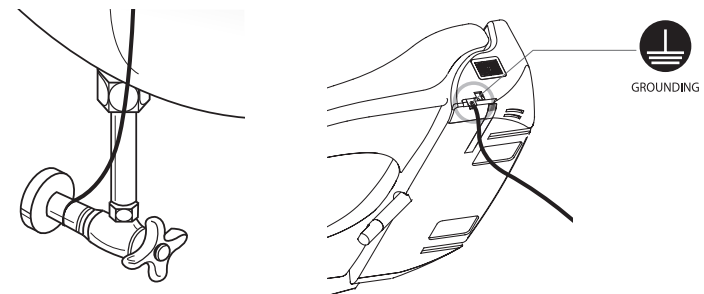

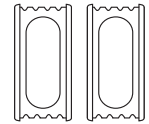
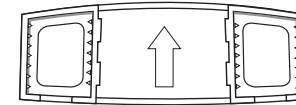
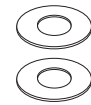
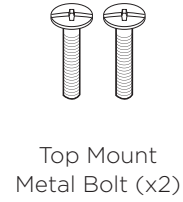
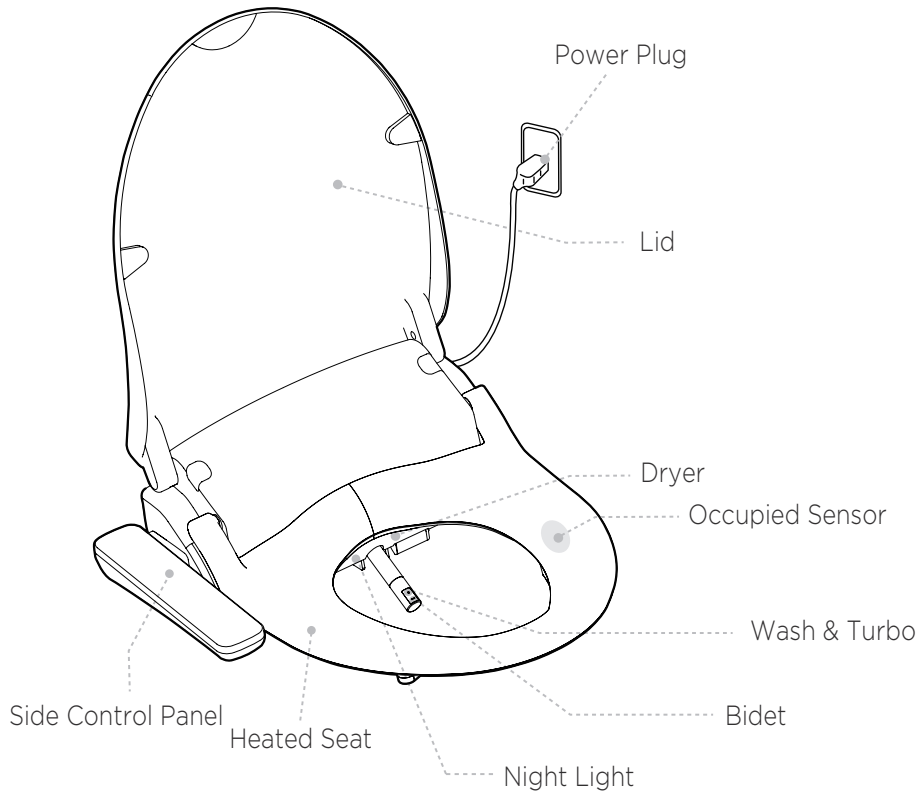

Washer (x2)

Catch Plate

Bracket Holder

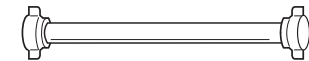
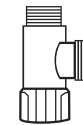
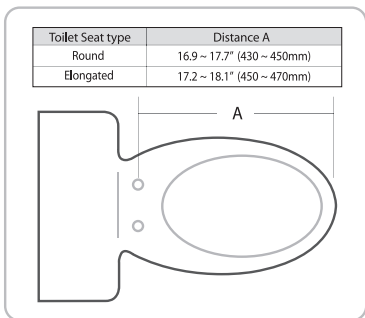

T-Valve 7/8"

Bidet Water  
Supply Hose

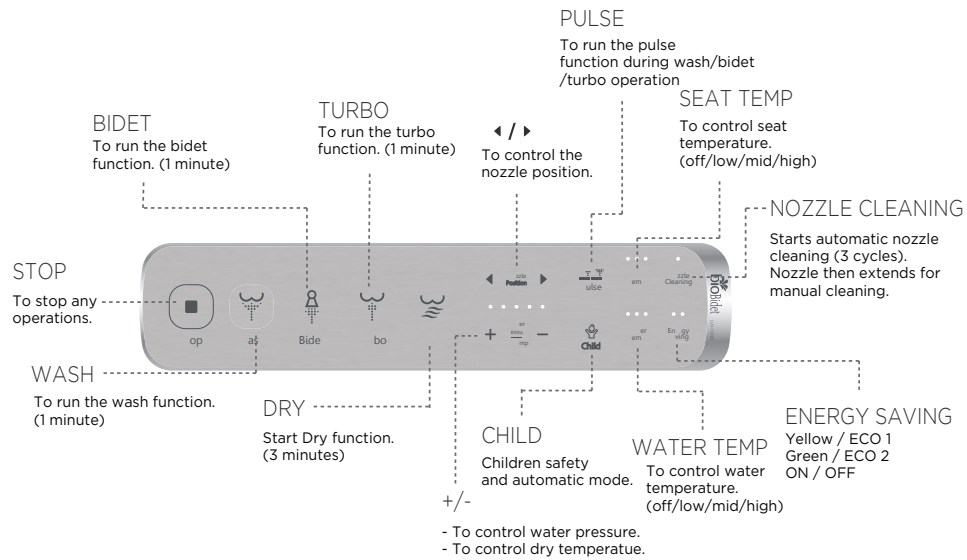

Elongated Type

Round Type

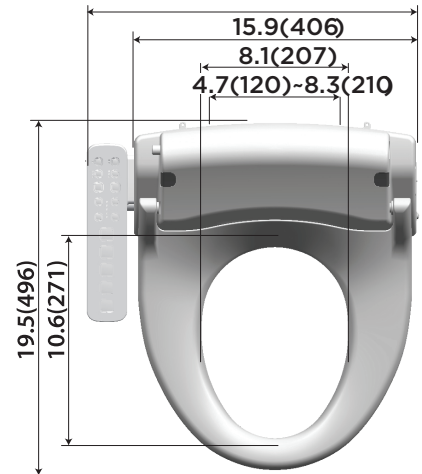
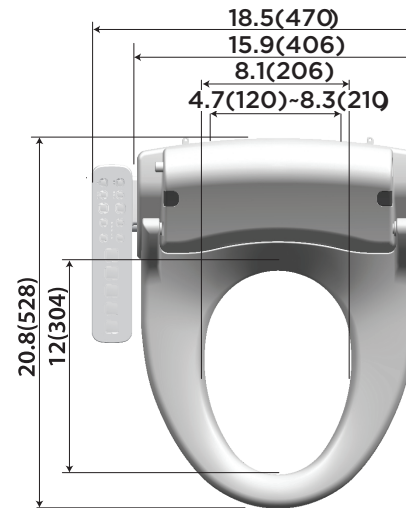

Check before requesting repair service.



## 1. Remove the seat from the existing toilet body.

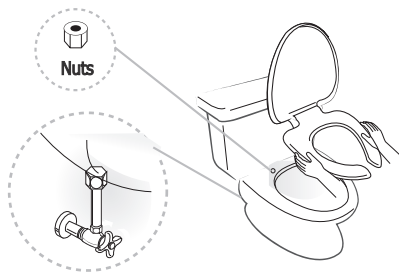

- Release the nuts, and then remove the seat and cover from it.
- Store the seat in a proper place for future use.
- Turn off the water and flush the toilet.

## 2. Install the T-valve.

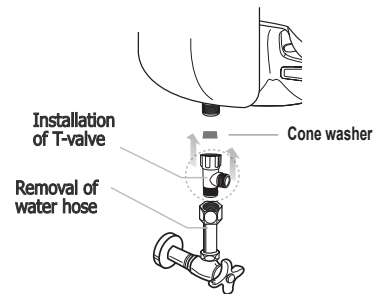

- Disconnect the existing water hose.
- Attach the T-valve to the bottom of the toilet.
- Ensure the rubber washer is properly seated and attach the original water hose to the T-valve.

## 3. Fix the catch plate onto the toilet.

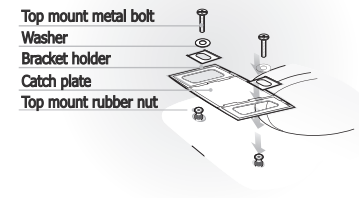

- Place the catch plate on the toilet with the arrows pointing towards the toilet tank.
- Align the bolts guides over the toilet bolt holes.
- Secure the catch plate to the toilet by hand tightening the bolts.

## 4. Push the main body towards the catch plate completely.

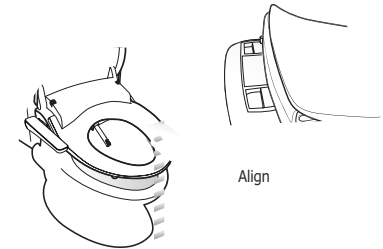

- Push it until you hear a “click.”
- When the product is not installed well, it may cause leakage.
- Adjust as needed before tightening bolts.

\*Do not over tighten bolts



5. After installing the T-valve, connect the supplied bidet hose from the center of the T-valve to the bidet.

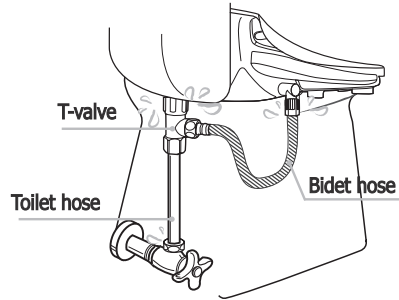

\*Do not overtighten connections.

6. Turn on the water and check for leaks

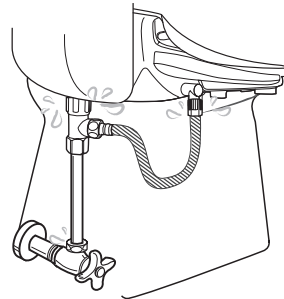

7. Plug in and be sure that the nozzle comes out and retracts when powered on.



Don't plug the power cord with wet hands. Risk of electric shock.

**Using inline carbon filter**

Use of external water filter is only recommended in areas with known hard water issues. If a filter is used, it must be replaced every 3 months.

This product is designed and intended for use exclusively with Bio Bidet DIB water filters. The purchase or use of any other water filter is not the responsibility of BBC Innovation LLC. As such, any use of non DIB water filters is prohibited and will void the warranty for those Bio Bidet products.

Bio Bidet will not be responsible for any resulting damages or claims related to the misuse or distribution of non Bio Bidet DIB filters.





## 1. Sit on the toilet seat

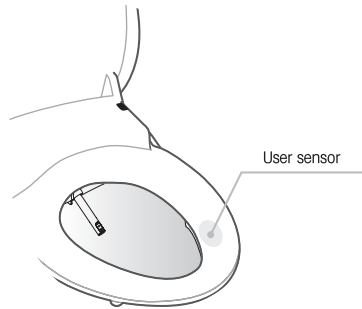

- Be sure to sit on the seat sensor. If the sensor is not occupied, all functions will not operate.
- Skin to seat contact needs to occur to activate the seat.

## 2. Wash, Bidet, Turbo



- Activate a cleansing function by pressing the corresponding button.
- When pressing the selected function again, the nozzle will oscillate back and forth to wash a wider range.
- Press the button once again to stop oscillate function.
- The specialized water spray in Turbo function helps relieve constipation.

## 3. Dry Temperature Control

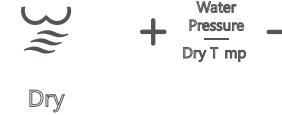

- Dryer operates for 3 minutes.
- Dryer temperature is adjustable by pressing "+" or "-" buttons. (5 Levels).
- Dryer effect will be improved if you wipe the moisture lightly before operating the drying function.

## 4. Pulse



- When pressing the Massage button during the operation of Wash, Bidet, and Turbo, water pressure will repeat high and low for smooth pulsating wash.
- Pulse function will not operate during the operation of Sitz bath\*

\*See how to use in page 26



5. Child Function



- When selecting Child Function settings adjust to low pressure.
- 1 min Bidet - 30 sec Bidet  
Oscillating - 30 sec Bidet Pulse

What it does

- Extra extended nozzle position
- Lower water pressure
- Lower seat temperature
- Lower water temperature

6. Nozzle Position Control

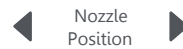
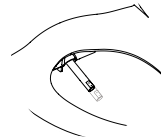

- Nozzle position is adjustable. (5 positions)

7. Water Pressure Control

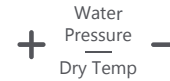

- Water pressure is adjustable (5 levels)
- If the water or screen filters become blocked, it may cause low water pressure. Regularly check the water and screen filters.

8. Stop

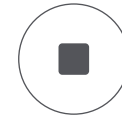

- All operations will stop.
- When pressing the stop button for 3 seconds, unit will turn off.
- Press Stop, Wash, Bidet, or Turbo to turn on.



### 9. Seat/Water Temperature Control



- Seat/Water temperature is adjustable. (4 levels) (Off - Low - Middle - High)
- To reduce the chance of low temperature burns, the seat has a safety feature that tuns to low temperature (35°C, 95°F) when seat is occupied for more than 15 minutes consecutively.

### 10. Energy Saving Function

#### Eco 1

- This mode is activated by pressing the Energy Saving button until the yellow LED lamp lights up. (Seat and water temperature will be kept at 32°C)

#### Eco 2

- This mode is activated by pressing the Energy Saving button until the green LED lamp lights up. (Seat and water heater will be kept off until seated)

#### Eco Off

- Press the Energy Saving button until LED lamp turns off.

When the unit is occupied, it adjusts to the present temperature and it returns to the saving mode when the seat is unoccupied.

If the seat and water temperature are off, they will remain off.

### 11. Nozzle Cleaning



- When selecting Nozzle Cleaning while not seated, the nozzle cleans itself 3 times. The nozzle extends and stops for manual cleaning process.
- Clean the nozzle with a brush and press STOP button after completion of manual cleaning. Then nozzle cleans itself for 3 times and retracts.
- NOZZLE CLEANING will not operate if the seat sensor is activated.

### 12. Night Light

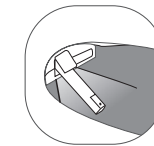

3 Seconds



- Blue LED night light provides enough brightness to see the toilet without turning on the bathroom light.
- Night light can be turned on and off by pressing “+” for 3 seconds while not seated.
- Night light setting cannot be adjusted if seat sensor bypass feature is activated.



13. Automatic Tank Draining

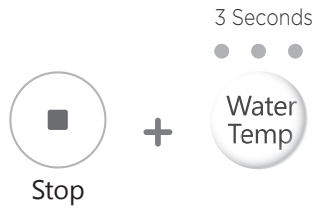

- To protect from water contamination, the water tank will be drained (replaced) for 2 minutes if the seat is not used for 48 consecutive hours.
- This feature is deactivated from the factory. To activate this feature, press Stop and Water Temp. button for 3 seconds.

14. Sitz Bath



- Wash or Bidet is switched to Wash Sitz Bath or Bidet Sitz Bath if Nozzle Cleaning button is pressed during use.
- Water pressure is switched to 1st level regardless of preset water pressure settings and Sitz Bath operates for 5 minutes.
- LED of Nozzle Cleansing turns on during the operation of Sitz Bath.
- Select the Nozzle Cleaning again to switch to normal Wash or Bidet.

15. Seat Sensor Bypass

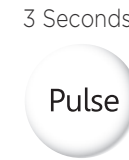

- The seat sensor can be activated and deactivated by pressing Massage button for 3 seconds.
  - If the seat sensor is deactivated, the unit works without occupying the seat and select features\* cannot be controlled.
- \*Features: Night Light, Silent mode, Nozzle cleaning.

16. Reset

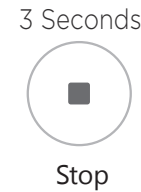

- Press and hold the Stop button on the auxiliary panel for 5 seconds.
- After 3 seconds, the seat will power off. Keep holding another 2 seconds and the seat will power back on. This completes the factory reset process.



## 1. Screen Filter Cleaning

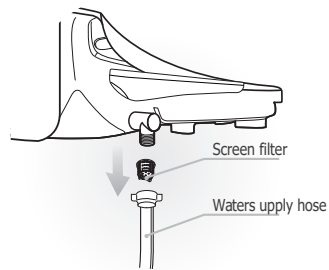

- Close the water valve.
- Disconnect the water supply hose. Take the screen filter out and clean it with a soft brush.
- Return the filter after cleaning and reconnect the water supply hose.
- Open the water valve.

## 2. Seat Cleaning

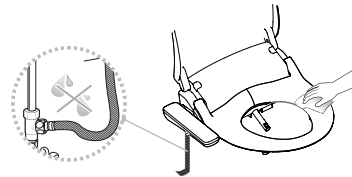

- Exterior surface of unit is made of plastic material, which may be damaged by scrubber, chemicals, etc.
- Wipe the surface with a soft damp cloth. Do not spray water directly onto the surface.
- Clean the body after removing the power plug from the outlet. Be sure no water splashes onto the power plug or outlet.
- Be careful of not dropping any chemical detergents or toilet cleaner on the main body or supply hose to avoid damage.

## 3. Extended Non-Use

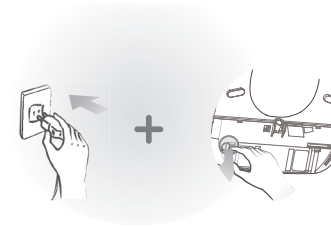

- When the bidet seat is not being used for an extended period of time, unplug the unit and drain the tank.

## 4. Draining of Tank

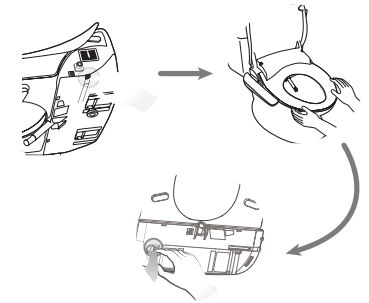



- Remove the power plug from the outlet.
- Close the water feed valve.
- Press the release button and gently pull to remove the unit from the catch plate.
- Use a flat-head screwdriver to open the drain plug.



**User settings with the remote control**

- Seat sensor “off”      ○ Seat sensor “on”      ● Regardless of on/off

No.	Function	Seat Status	Switch Operation	Description	Initial Status
1	Silent mode	●	“-” for longer than 3 seconds.	To turn on/off the operating chime sound.	ON
2	Power Off	●	“⏻” for longer than 3 seconds.	Press one of Stop, Wash, Bidet, Intensive or Dry to power on.	
3	Seat Sensor Bypass	●	“  ” for longer than 3 seconds.	Seat sensor feature will be deactivated	OFF
4	Night Light	●	“+” for longer than 3 seconds.	To turn on/off the night light.	ON
5	Factory reset	●	Press and hold the Stop button for 5 seconds.	After 3 seconds, the seat will power off. Keep holding another 2 seconds and the seat will power back on. This completes the factory reset process.	ON
6	Automatic tank draining	●	“⏻” and “  ” for longer than 3 seconds.	Automatic tank draining feature will be deactivated.	OFF

\*The unit will work without sitting on the seat if the occupied seat sensor is deactivated. (Turn off)

\*If the seat sensor is deactivated, some features cannot be controlled. (Night light on/off, silent mode on/off, and nozzle cleaning.)

**Please check the following points before requesting repair service**

Problem	Check List
Completely out of order.	<ul style="list-style-type: none"> <li>• Check if the power plug is not connected.</li> <li>• Check if the power supply or outlet has failed.</li> </ul>
Water does not spray out.	<ul style="list-style-type: none"> <li>• Check if the water supply is turned on.</li> <li>• Check if the water valve is open.</li> <li>• Check if the nozzle is blocked by foreign material.</li> <li>• Check if connection hose is bent.</li> </ul>
Water pressure is low.	<ul style="list-style-type: none"> <li>• Check if screen filter is blocked and clean if needed.</li> <li>• Check if the water pressure is set at too low level.</li> </ul>
Water is not warm enough.	<ul style="list-style-type: none"> <li>• Check if its temperature is set at off or low level, or economy mode.</li> </ul>
Seat is not warm enough.	<ul style="list-style-type: none"> <li>• Check if its temperature is set at off or low level, or economy mode.</li> </ul>
Water tank is drained intermittently.	<ul style="list-style-type: none"> <li>• Check if the automatic water draining feature activates.</li> </ul>



Please check the following table and inform the exact status when requesting repair service.

No.	Self Diagnosis	Indication
1	Water temp sensor is disconnected or not inserted	LEDs of water low + middle level blinking
2	Water temp sensor is short-circuited or overheated	LEDs of water high + middle level blinking
3	Seat temp sensor is disconnected or not inserted	LEDs of water low level blinking
4	Seat temp sensor is short-circuited or overheated	LED of water high level blinking

Item		LW-1000	
Rated Voltage		AC 120V, 60Hz	
Max. Power Consumption		870W	
Power cord length		1.2m	
Water feed method		Directly connects to water pipe	
Recommended inlet water pressure		9.95-106.7 psi	
Wash	Feed Volume	Wash	0.13-0.21 gal/min
		Bidet	0.13-0.18 gal/min
		Turbo	0.13-0.18 gal/min
		Child	0.13-0.16 gal/min
	Pressure control		5 Levels
	Temperature Control		4 Levels (off - low - middle - high)
	Heater capacity		800W
	Safety device		Water level sensor, Thermal fuse, Bi-metal, temperature sensor
Heated Seat	Temperature control		4 levels (off - low- middle - high)
	Heater capacity		55W
	Safety device		Thermal fuse
Dry	Temperature control		Room temp. ~ 122°F
	Heater capacity		250W
	Safety device		Thermal fuse, Bi-metal
Feed water temp. tolerance range		37 ~ 95°F (recommended 54 ~ 95°F)	
Usage room temp. tolerance range		37 ~ 104°F (recommended 50 ~ 95°F)	
Dimension	Elongated	18.6" (470) x 20.8" (528) x 7.0" (178)	
	Round	18.6" (470) x 19.5" (496) x 7.0" (178)	
Weight Net weight (Gross weight)	Elongated	17.4 lb (17.4)	
	Round	17.1 lb (17.2)	



- We hereby guarantee the product as follows in accordance with the regulation of consumer damage compensation.
- In case of product failure, please contact Bio Bidet
- Product warranty will be effective for one year from the date of purchase.

## **Regarding Product Warranty Regulation**

- We will repair the product free of charge in case it fails under normal operating circumstances in accordance with the user guide during the warranty period.
- Although it is within the warranty period, we will charge the repair service fee etc. (repair + parts + travel expense) if it falls under the following cases:

## **Voiding Warranty**

- Defects occurred from the user's careless handling
- Defects occurred from usage with incorrect power voltage (E.g. 220V was used to the 110V product.)
- Defects occurred from Force Majeure (fire, salt, flood, etc.)
- Failure or damage due to mishandling during operation after installed.
- Defect occurred from interior modification at user's discretion.



# Thank You



Technical Support/Customer Service  
7900 S Route 31 Crystal Lake, IL 60014  
T: 847.458.2334  
U.S. TOLL FREE: 877.339.5214

[support@biobidet.com](mailto:support@biobidet.com)  
[www.biobidet.com](http://www.biobidet.com)