

PEARL

bidet sprayer



**bioBidet**[®]
by **BEMIS**

User Manual

HSB-100
HSW-100

TABLE OF CONTENTS

PRODUCT INFORMATION

Features.....4
Parts.....5

PRODUCT INSTALLATION

Pre-Installation.....6
Installation.....7

PRODUCT OPERATION

Operation.....12
Cleaning.....13

WARRANTY

Warranty.....14

FEATURES

- High quality silver brass valve
- Magnetic Dock
- Adjustable water pressure
- 6" Comfortable handle body
- Easy D.I.Y. installation
- Ambient temperature bidet wash
- 58" Metal spiral hose
- No electricity or batteries required
- One year warranty

PARTS

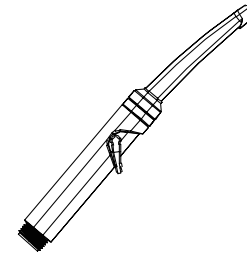

Handheld Bidet

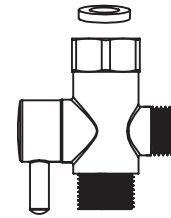

T-Valve Shutoff
(Be sure Flat Washer is inside end of T-Valve)

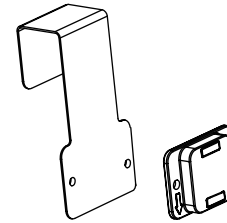

Stainless steel hook/
Magnet sprayer holder

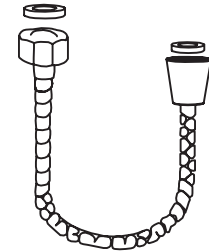

Stainless Steel
Supply Hose

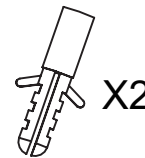

Expanding nut



short screw



expanding screw

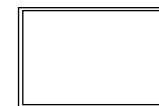

Double sides
adhesive tape

PRE-INSTALLATION

CAUTION:

Do not over tighten any connections. Over tightening connections can cause damage to the parts and cause leaking.

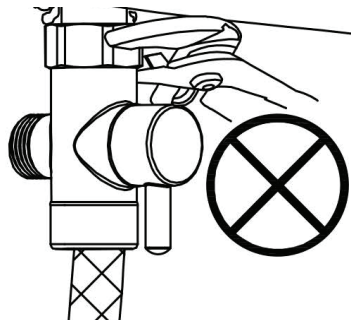
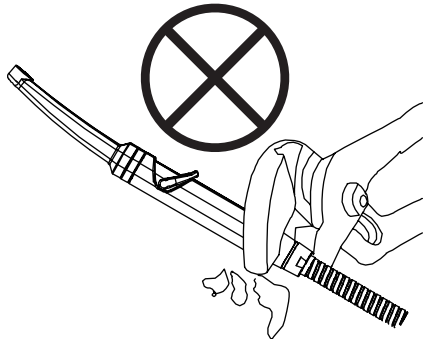

NOTICE:

Observe all local plumbing, electrical, and building codes.

When installing this unit, be sure that the water supply valve is fully turned off. Failure to do so can result in flooding and water damage.

INSTALLATION

1. Shut off the water supply to the toilet.

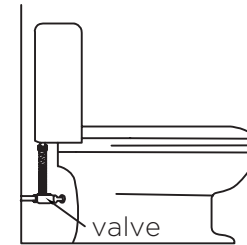

- Flush the toilet to drain all water inside the tank.

2. Disconnect the supply line from the toilet fill valve.

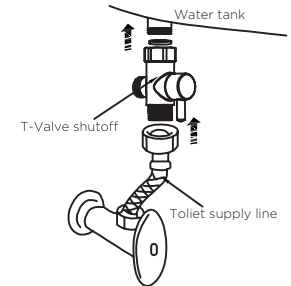

- Attach the 7/8" T-valve shutoff to the threaded fill valve on your toilet. Be sure the 7/8" flat washer is in the T-valve before installing. Position the T-valve so that the shutoff handle is facing the front of the toilet.

INSTALLATION (CONT.)

3. Reattach your existing toilet supply line.

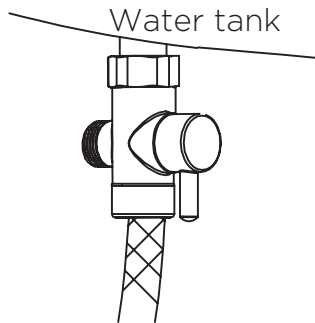

- Reattach your existing toilet supply line to the bottom of the T-valve. Be sure all connections are secure, and no leaking or water is present.

4. Remove protective plastic covers

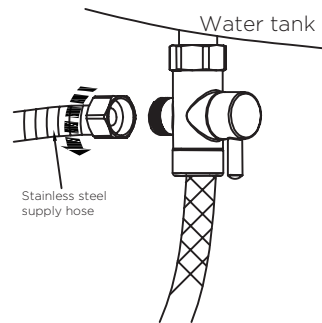

- Remove protective plastic covers on threaded caps from the ends of the 48" stainless steel supply hose. Attach the hex-head end of the hose to the T-valve.

5. Attach the Handheld Bidet to the other end of the supply hose.

- As a precaution, slide the level on the handheld bidet sprayer to "off," which is away from the sprayer head.

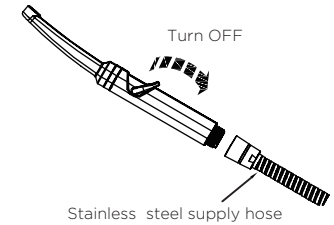

NOTICE

This device is designed for connection to a cold water source with a pressure of 20-80 psi.

INSTALLATION (CONT.)

6. Mounting Spray

Option 1: Toilet Mount

- Install the magnet sprayer holder onto the hook with the short screws like in the picture shown. Carefully remove the toilet lid and place the holder in the desired location.

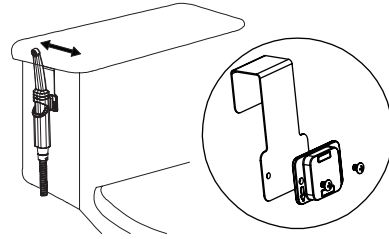

7. Turn on the water supply valve.

- Turn on the water supply valve on the back wall and check for any leaks. Use common plumbers tape if necessary on any leaking threads, reattach and test again. Carefully remove toilet lid and place holder in desired location.

Option 2: Wall mount

- Use the included screw to attach the magnet sprayer holder to the wall.
- Make sure to use an expanding nut if you are attaching to dry wall.

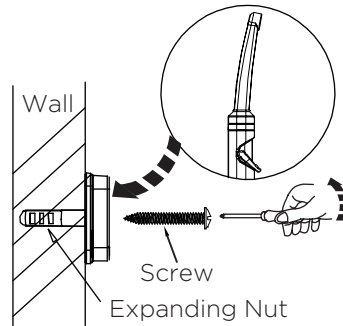

Option 3: Wall mount

- If the wall is glossy, wipe it clean and dry. Place the double sides adhesive tape on the magnet sprayer holder and firmly press to the wall.

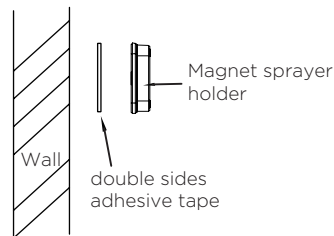

OPERATION

How To Use

- Open the T-valve to allow water to flow to the Handheld Bidet Sprayer.
- Direct the Handheld Bidet to the appropriate area and slide the lever to the “on” position.
- When finished, slide the lever to the “off” position and close the T-valve.

NOTE: THE T-VALVE MUST BE SHUT OFF AFTER EACH USE.

Failure to turn off after each use may cause flooding and water damage. BBC Innovation LLC is not responsible for damage that is caused by failure to follow this instruction.

CLEANING

Cleaning the Bidet Sprayer

Your bidet sprayer is made with a higher grade fire-retardant ABS resin. Using harsh cleaning chemicals can weaken the material causing it to damage and develop cracks.

- Clean the bidet sprayer by wiping the surface area with a damp cloth regularly.
- Do not use harsh detergents or any cleaning tools with bristles on your bidet.
- Steam cleaning is the preferred cleaning method for your bidet. For a deep chemical free clean, consider the Bio Mist Bidet Cleaner.

NOTE:

If any leaks occur, check all rubber washers and make sure all connections are tight and secure. If leaking persists, discontinue use of the unit, turn off the water source and contact support@biobidet.com.

WARRANTY

Your Bio Bidet is warranted against defects in materials or workmanship for one (1) year from the date of original purchase. Defective parts or a defective product returned to Bio Bidet will be repaired with new or comparable rebuilt parts or exchanged for a Refurbished Bio Bidet as determined by Bio Bidet in their sole discretion.

This limited warranty given by Bio Bidet covers all defects encountered in normal use of Bio Bidet, and do not apply in the following cases:

1. Loss of or damage to Bio Bidet due to abuse, misuse, tampering, mishandling, improper packaging by you, alteration and failure follow operating instructions.
2. Use of parts or supplies (other than those by Bio Bidet's dealers) that cause damage to Bio Bidet.
3. Replacement of discolored or stained parts caused by chlorine, bleach, ammonia, and other chemicals, cleaning supplies, oxidation, normal wear and tear.
4. Damage to or malfunction of the unit as a result of improper and negligent installation.
5. Any and all damages to plumbing, walls, floors, ceiling and personal properties resulting from water leaks or breakage. The product must be used at the user's own risk. Therefore, the owner hereby releases the manufacturer and distributor from any and all claims for damages where the above condition exists.

No implied warranty, including any implied warranty of merchantability or fitness or a particular purpose, applies to BBC Innovation LLC bidet after the applicable period of the express limited warranty stated above, and no other express warranty or guaranty, except as mentioned above, given by any person or entity with respect to Bio Bidet shall bind Bio Bidet, (some states and provinces do not allow limitations on how long an implied warranty, so the above limitation may not apply to you). BBC Innovation LLC shall not be liable for revenues or profits, inconvenience, expense for substitute equipment or service, or any other special, incidental or consequential damages caused by the use or misuse of, or inability to use, Bio Bidet regardless of the possibility and foresee-ability of such damages. In no event shall recovery of any kind against BBC Innovation LLC be greater in amount than the purchase price of the product and causing the alleged damage. Without limiting the foregoing, you assume all risk and liability for loss, damage, or injury to you and your property and to others and their property arising out of use or misuse of, or inability to use, the Bio Bidet not caused directly by the negligence or BBC Innovation LLC. This limited warranty shall not extend to anyone other than the original purchaser of the Bio Bidet.

Thank You



Technical Support/Customer Service
7900 S Route 31 Crystal Lake, IL 60014

T: 847.458.2334

U.S. TOLL FREE: 877.339.5214

support@biobidet.com

www.biobidet.com