

---

# BB-1200L

## USER MANUAL

**BIOBIDET<sup>®</sup>**  
*BY BEMIS*





**Questions?  
We're here to help.**

847.458.2334  
support@biobidet.com  
www.biobidet.com

Technical support and  
alternate fittings are available.

## 04

### PRODUCT INFORMATION

Important Safeguards  
Overview & Parts

## 08

### GETTING STARTED

Remote Control  
Functions & Features

## 12

### INSTALLATION

Installation Guide

## 15

### MAINTENANCE

Draining The Warm Water Tank  
Cleaning The BB-1200L  
Cleaning The Strainer  
Troubleshooting Guide  
Specifications

## 19

### WARRANTY

Warranty  
Notes

## PLEASE OBSERVE THE FOLLOWING PRECAUTIONS AND INSTRUCTIONS BEFORE INSTALLATION AND USE.

- This product must be connected to a grounded 120V GFCI (Ground Fault Circuit Interrupt) outlet. Do not connect the power cord if it is damaged or broken. Do not plug the product into a loose electric outlet.
  - It is recommended to operate this product on a separate circuit. Sharing a circuit could cause the breaker to trip or lights to flicker.
  - If it is necessary to use an extension cord, use only a three-prong extension cord plugged into a proper GFCI outlet. The marked rating of the extension cord should be equal to or greater than the electrical rating of the unit (15 amp). Consult a qualified electrician or service person if you are not sure whether the unit is properly grounded.
- Do not open this product for repair without authorization from the manufacturer. Only qualified service personnel should service this product. Do not use accessories not recommended by the manufacturer.
- Connect this product to a cold water supply line.
- Close supervision is necessary when this product is used by children, elderly, or adults with sensitive skin. A low temperature burn may occur when the skin has been in contact with an object at relatively low temperature for an extended period of time.
- If using any chemical toilet bowl cleaner, be sure to wipe up any spills that splash onto the bidet. Do not use benzene or any acid chemical detergent, as they can cause discoloration. Only neutral detergents are permitted.
- Do not plug in the power cord before connecting the water supply hose.
- Install in an area with adequate ventilation to avoid high levels of humidity which can damage the electronic components.
- Do not touch the power cord with wet hands or reach for a product that has fallen into water. Unplug immediately.
- Unplug the bidet seat when cleaning or detaching from the toilet bowl. Do not plug in until plumbing work has been completed.
- Keep the power cord away from heated surfaces to prevent a fire hazard. Keep any flammable materials away from this product at all times.

Water Does It Better®

BB-1200L

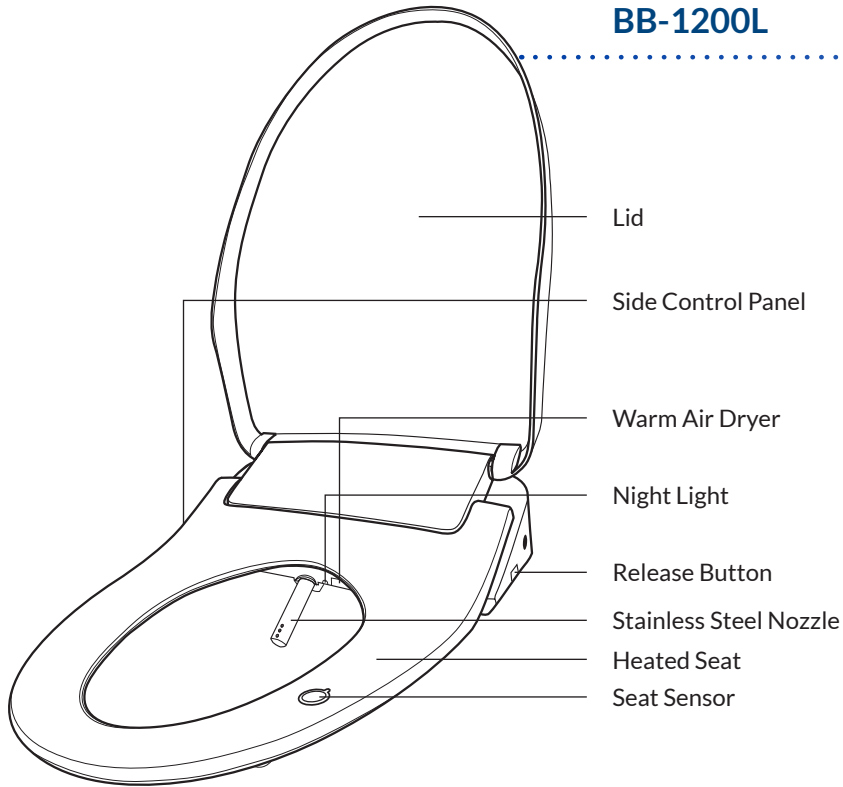

Side Control Panel

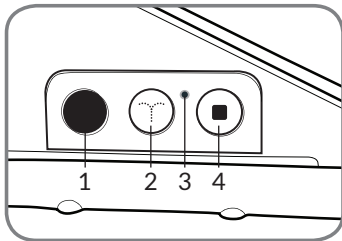

- 1. Remote Receiver
- 2. Rear Wash
- 3. Power/Eco Mode LED
- 4. Stop/Power Button  
(Hold the button for 3 seconds to power off.)

Stainless Steel Nozzle

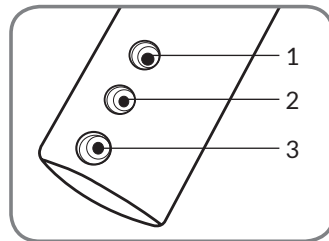

- 1. Turbo Wash
- 2. Rear Wash
- 3. Front Wash



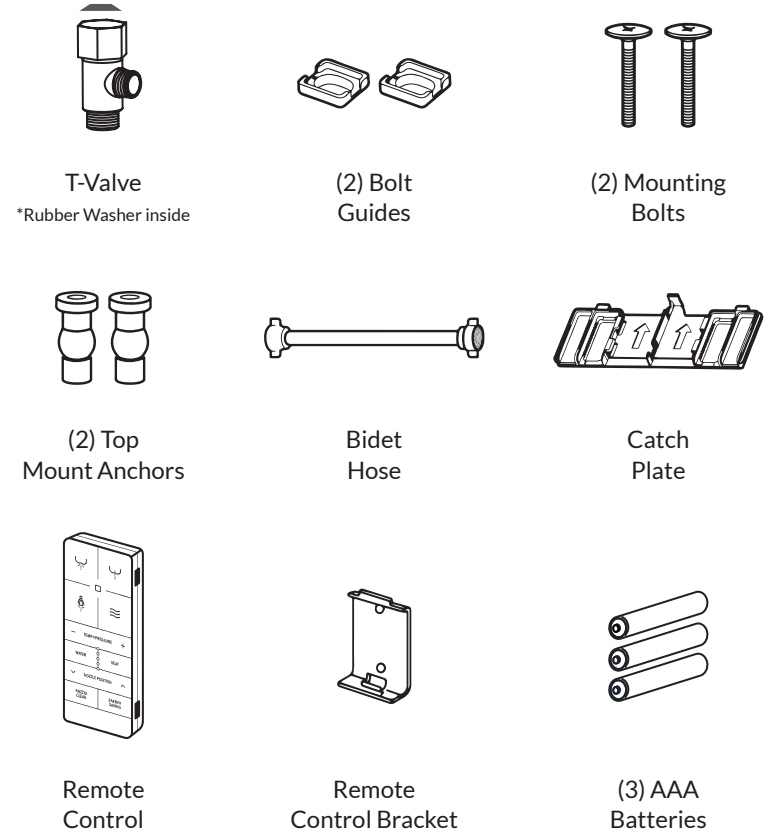



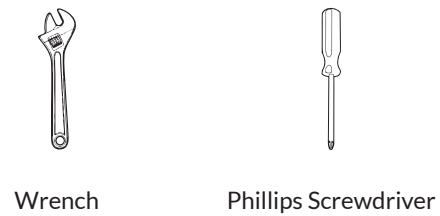

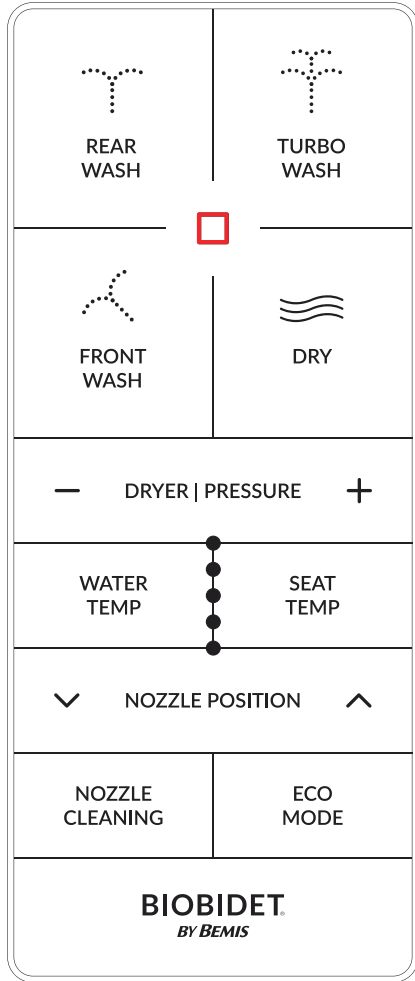

BB-1200L Parts List



Recommended Installation Tools









-  Stop Button
-  Rear Wash
-  Front Wash
-  Turbo Wash
-  Warm Air Dryer
-  Adjustable Water Pressure/  
Adjustable Dryer Temp.
-  Adjustable Water Temp.
-  Adjustable Heated Seat
-  Adjustable Nozzle Position
-  Nozzle Cleaning
-  Eco Mode

The BB-1200L is a bidet toilet seat designed for superior hygiene, comfort, and sustainability. Each use will leave you feeling clean and confident, while reducing your overall footprint.

**Sit Down On The Seat**

This product includes a built-in seat sensor that must be activated with skin contact in order to operate bidet functions.

-  **Stop Button**  
Press to stop a wash or dry function.
-  **Rear Wash**  
Press to activate the rear wash cycle, carefully crafted with the optimum cleansing angle and spray pattern. Press again to oscillate. This wash cycle will automatically turn off after 2 minutes.
-  **Front Wash**  
Press to activate the front wash cycle, which offers an alternate accommodating spray pattern. Press again to oscillate. This wash cycle will automatically turn off after 2 minutes.
-  **Turbo Wash**  
Press to activate a focused wash with higher water pressure. Press again to oscillate. This wash cycle will automatically turn off after 2 minutes.
-  **Warm Air Dryer**  
Press to activate the warm air dryer. Adjust the dryer temperature by pressing “+” and “-”. (Temperature can be adjusted up to 5 levels.)



### Adjustable Water Pressure

Press “+” or “-” during a wash cycle to adjust the water pressure to your desired level.



### Adjustable Water Temperature

Adjust the water temperature by pressing the corresponding button to cycle through 5 temperature levels.



### Adjustable Heated Seat

Adjust the heated seat by pressing the corresponding button to cycle through 5 temperature levels.

### Auto Oscillation

Press “Stop” and “^” during a wash cycle to turn automatic oscillation on/off.



### Adjustable Nozzle Position

Push the “^” or “v” during a wash cycle to adjust the nozzle position.



### Nozzle Cleaning

- This product has an automatic nozzle cleaning function that rinses the nozzle before each use.
- Press “Nozzle Cleaning” to activate a nozzle cleaning cycle that rinses the nozzle 10 times.
- Press and hold the “Rear Wash” button on the remote control for 3 seconds while the seat is unoccupied to extend the nozzle without spraying for 2 minutes. Gently clean the nozzle with a soft cloth or toothbrush. Press the “Stop” button to retract the nozzle.



### Eco Mode

Press to turn energy saving functions on/off. When enabled, eco mode will decrease temperature settings when not in use.

### Night Light

Press the “Stop” and “Turbo Wash” buttons for 3 seconds to turn the night light on/off.

### Seat Sensor

Press the “Stop” and “Nozzle Cleaning” buttons to turn the seat sensor on/off.

### Sounds On/Off

Beeping can be enabled or disabled by pressing and holding the “Stop” and “+” buttons while the seat is unoccupied.

### Pairing The Remote ID

Follow these instructions if the remote disconnects from the unit.

1. Press “Stop” and “Seat Temp” for 3 seconds. Channels will show up on the LEDs. Set desired channel with “+” and “-”. Press “Stop” to save settings.
  - Channel 1-5 - LEDs flashing  
Channel 6-10 - LEDs on
2. Press “Stop” and “Rear Wash” on the side control panel for 3 seconds. The LED will start flashing. Press “Stop” on the remote to finish the channel setting. To reset all remote settings, press “Stop” and “Front Wash” for 3 seconds.

**BEFORE INSTALLATION**

Do not plug the power cord in until installation is complete.

Please contact our service center at 847.458.2334 for alternate fittings or assistance with this process.

**1. Turn Off Water**

Turn off the water shut-off valve. Drain the toilet tank completely by flushing the toilet. Unscrew the hose connected to the toilet tank.

You may want to have a towel ready to catch any residual water.

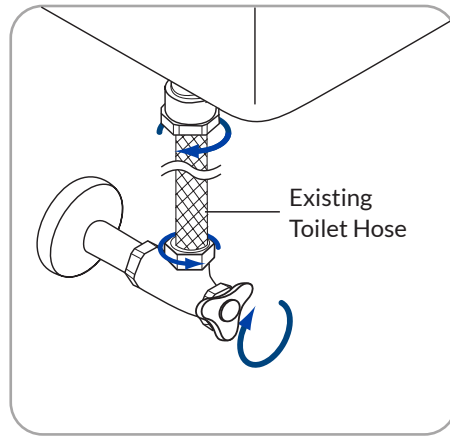

**2. Remove Toilet Seat**

Unscrew the nuts on both sides of the toilet to release the existing toilet seat from the toilet.



**3. Install Catch Plate**

Insert the top mount anchors into the toilet bolt holes. Insert the mounting bolts through the guides, catch plate, and mounting holes and into the top mount rubber anchors. Fasten with a phillips screwdriver to secure the catch plate on the toilet.

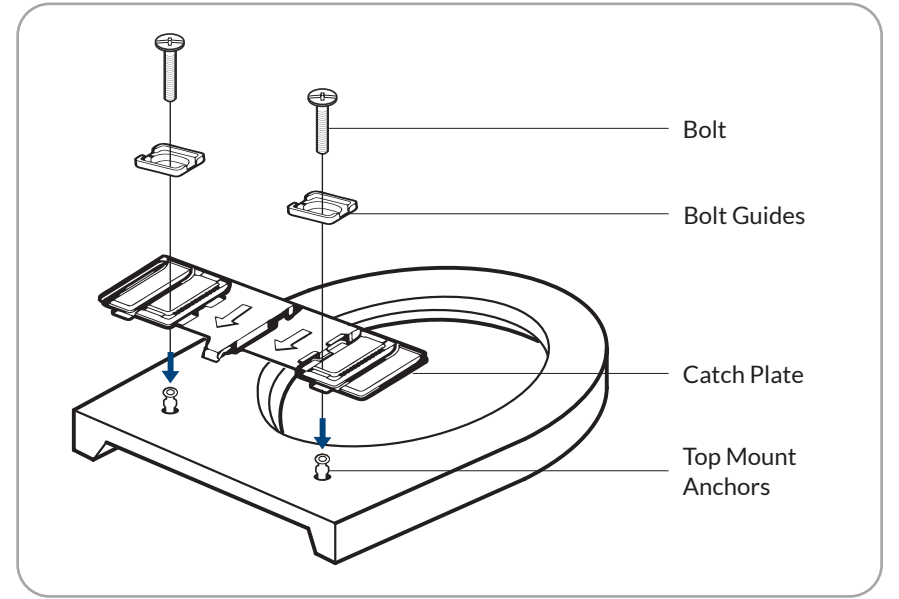

**4. Install Your BB-1200L**

Align the bidet seat with the catch plate and slide it all the way back until you hear a click.

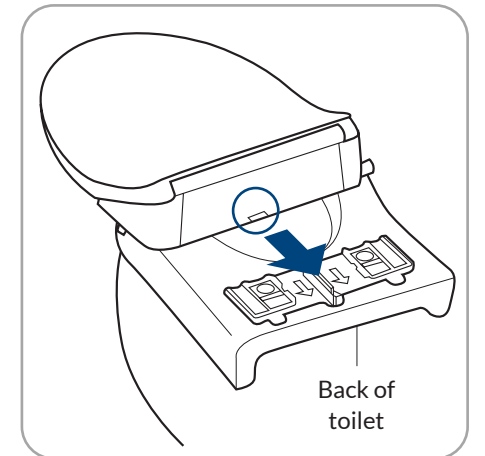

## 5. Connect the Water Hoses

1. Install the t-valve onto the toilet tank. Ensure the rubber gasket is properly seated inside the t-valve.
2. Connect your existing toilet hose to the water shut-off valve and t-valve.
3. Connect the provided bidet hose to the bidet seat and t-valve.
4. Open the water shut-off valve. Check for any leaking or dripping. Use a wrench to tighten any loose connections.

**\*Shut-off valves may vary. If supplied parts do not fit, please call 847.458.2334. Alternate fittings are available upon request.**

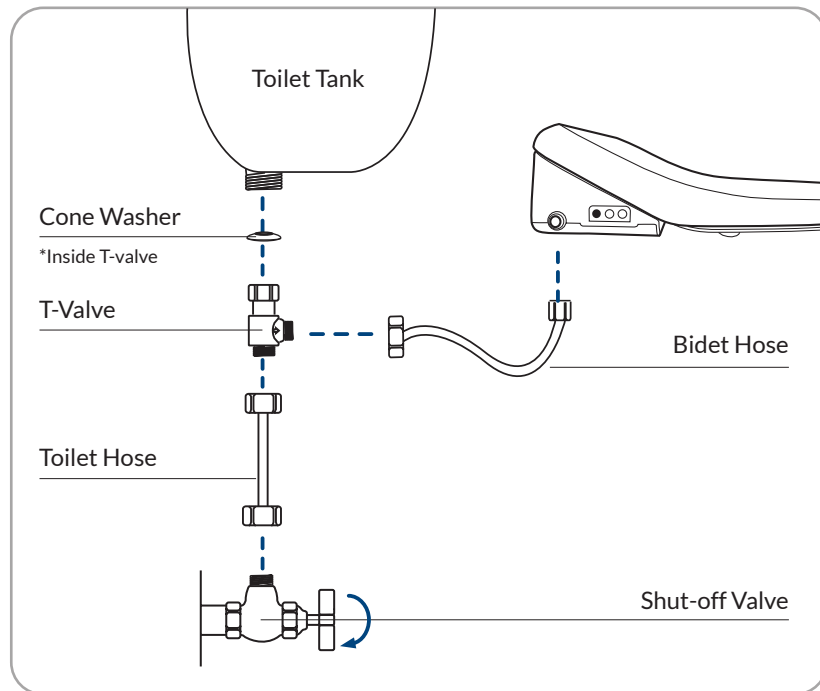

## 6. Plug It In!

Plug the power cord into a 120V power outlet. The BB-1200L will beep. Press "Rear Wash" while unseated. The water will start filling the tank and the bidet will beep. Once the tank is full, the beeping will stop.

## Draining the Warm Water Tank

If you do not intend to use this product for an extended period of time, drain the water from this product's warm water tank.

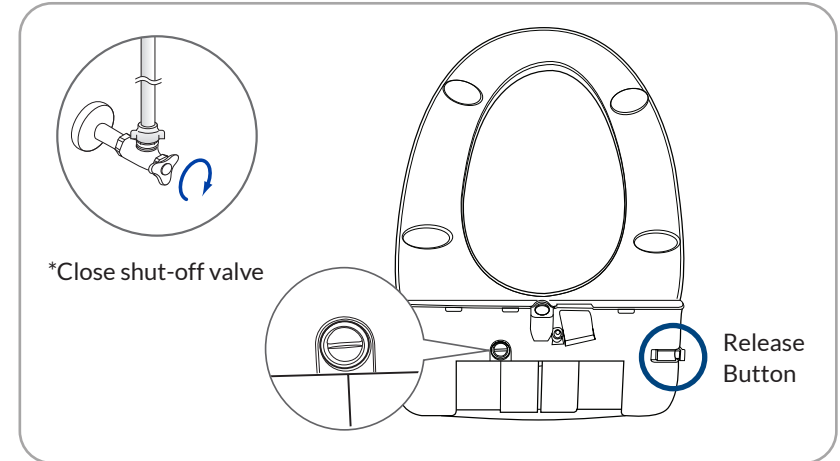

Before draining, unplug the power cord and wait 30 minutes until the unit has cooled down. Do not insert your finger into the drain hole.

1. Disconnect the power plug.
2. Close the water shut-off valve.
3. Press the release button on the right side of the bidet and pull it forward.
4. Open the drain cap located on the back and bottom of the product and drain out all the water in the tank. Beware of losing the drain bolt. Avoid placing the product in a fully upright position.



## Cleaning the BB-1200L

- When you clean this product, do not use thinner, benzene or toilet bowl cleaner, as it may cause discoloration or damage.
- Disconnect the power cord and use a wet cloth when you clean this product.

## Cleaning the Strainer

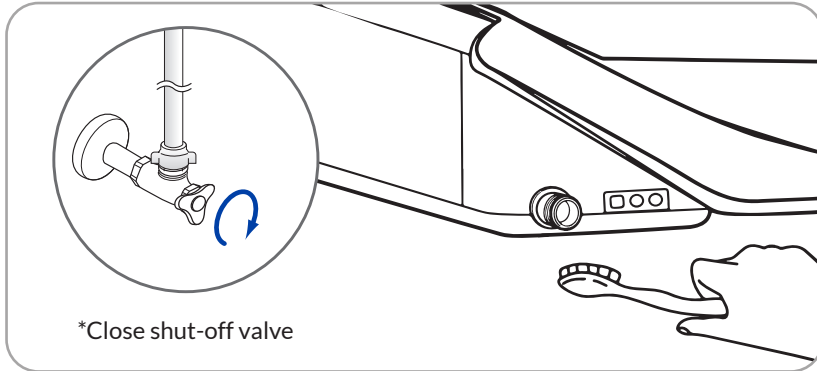

This product will not operate properly if the strainer is clogged. Please clean the strainer regularly.

1. Unplug the power cord. Close the water shut-off valve.
2. Unscrew the bidet hose from the bidet seat.
3. Clean the strainer with a small brush.
4. Re-connect the bidet hose. Open the water shut-off valve. Plug in the power cord.

| Problem                            | Check The Following                                                                                                                                                                          |
|------------------------------------|----------------------------------------------------------------------------------------------------------------------------------------------------------------------------------------------|
| Water does not spray               | <ul style="list-style-type: none"> <li>• Check if water supply is cut off.</li> <li>• Check if the strainer is clogged.</li> <li>• Ensure the seat sensor is activated.</li> </ul>           |
| The unit is not operating          | <ul style="list-style-type: none"> <li>• Check if power cord is plugged in.</li> <li>• Check the LED light on side control panel.</li> <li>• Ensure the seat sensor is activated.</li> </ul> |
| Water is leaking                   | <ul style="list-style-type: none"> <li>• Verify all connections are secure.</li> <li>• Contact customer support.</li> </ul>                                                                  |
| The water pressure is weak         | <ul style="list-style-type: none"> <li>• Check the pressure if set to low.</li> <li>• Check for any kinked hoses.</li> <li>• Check if the strainer is clogged.</li> </ul>                    |
| The heated seat is not warm enough | <ul style="list-style-type: none"> <li>• Check if the seat temperature is set to level 1.</li> </ul>                                                                                         |
| The water is not warm enough       | <ul style="list-style-type: none"> <li>• Check if the water temperature is set to level 1.</li> </ul>                                                                                        |
| The nozzle is stuck                | <ul style="list-style-type: none"> <li>• Ensure the seat sensor is activated.</li> </ul>                                                                                                     |
| The product is unstable            | <ul style="list-style-type: none"> <li>• Tighten the mounting bolts firmly.</li> </ul>                                                                                                       |
| The dryer is not working           | <ul style="list-style-type: none"> <li>• Ensure the seat sensor is activated.</li> </ul>                                                                                                     |
| The dryer has a smell              | <ul style="list-style-type: none"> <li>• The dryer may release a slight odor for the first few uses.</li> </ul>                                                                              |

| Specifications          |                           | BB-1200L                                                        |
|-------------------------|---------------------------|-----------------------------------------------------------------|
| Power Rating            |                           | 120Vac, 60Hz, 1270W                                             |
| Water Supply            | Water Supply Method       | Direct connection to waterworks                                 |
|                         | Water Pressure Range      | 0.07 ~ 0.74 MPa(0.7 ~ 7.5 kgf/cm <sup>2</sup> )                 |
| Power Cord              |                           | 4 feet                                                          |
| Wash Device             | Posterior Wash            | Max. 650 cc ± 100 cc                                            |
|                         | Feminine Wash             | Max. 650 cc ± 100 cc                                            |
|                         | Adjustable Water Pressure | 5 Levels                                                        |
|                         | Warm Water Temp           | Room Temp - Low, Normal, High                                   |
| Heated Seat             | Temperature               | Room Temp - Low, Normal, High                                   |
|                         | Heater                    | 1200 W                                                          |
|                         | Safety Devices            | Overheating preventing fuse, Seat heat temperature sensor       |
| Dryer                   | Temperature               | Room Temperature, ~131°F level 1-5                              |
|                         | Heater                    | 250 W                                                           |
|                         | Safety Devices            | Temperature fuse                                                |
| Inlet Water Temperature |                           | 41°F ~ 95°F ( 3°C~ 35°C )<br>(Recommended temp. - 50°F ~ 95°F)  |
| Ambient Temperature     |                           | 41°F ~ 104°F ( 3°C~ 40°C )<br>(Recommended temp. - 50°F ~ 95°F) |
| Dimensions              | Elongated                 | W: 18.11 in / L: 20.47 in / H: 5.31 in                          |
|                         | Round                     | W:15.43 in / L: 18.9 in / H: 5.71 in                            |
| Weight                  |                           | 7.9 lbs (Packaged: 11.4 lbs)                                    |

## 1 YEAR FULL COVERAGE WARRANTY

Bio Bidet Innovation LLC warrants its product to be free from manufacturing defects under normal use and service for a period of one (1) year from original date of purchase.

This warranty is extended only to the ORIGINAL PURCHASER.

- Bio Bidet Innovation LLC's obligations under this warranty are limited to repair or replacement, at Bio Bidet Innovation LLC's option, of products or parts found to be defective, provided that such products were properly installed and used in accordance with instructions.
- Bio Bidet Innovation LLC reserves the right to make such inspections as may be necessary in order to determine the cause of the defect.
- Bio Bidet Innovation LLC will not charge for labor or parts in connection with warranty repairs done at Bio Bidet Innovation LLC.
- Bio Bidet Innovation LLC is not responsible for the cost of removal, return, initial install, and/or re-installation of products.

This warranty does not apply to the following items:

- Damage or loss sustained in a natural calamity such as fire, earthquake, flood, thunder electrical storm, etc.
- Damage or loss resulting from any unreasonable use, misuse, abuse, negligence, or improper maintenance of the product.
- Damage or loss resulting from removal, improper repair, or modification of the product.
- Damage or loss resulting from sediments or foreign matter contained in a water system.
- Damage or loss resulting from improper installation or from installation of a unit in a harsh and/or hazardous environment.





**THANK YOU!**

10.17.23

**BIOBIDET<sup>®</sup>**  
***BY BEMIS***

**Customer Support**

**T: 847.458.2334**

**TOLL-FREE: 877.339.5214**

**7900 S IL Route 31 Crystal Lake, IL 60014**

**[support@biobidet.com](mailto:support@biobidet.com)**

**[www.biobidet.com](http://www.biobidet.com)**