

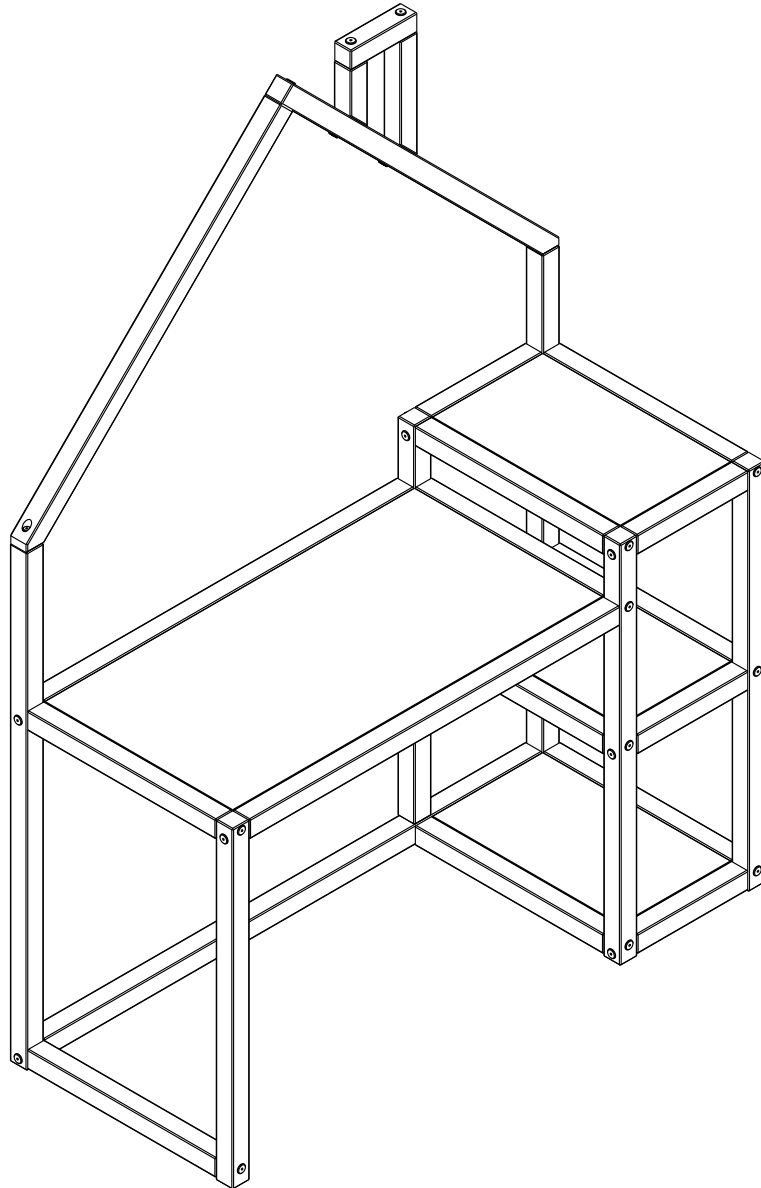

# Casita Desk



**READ ALL INSTRUCTIONS BEFORE ASSEMBLING DESK  
KEEP INSTRUCTIONS FOR FUTURE USE.  
THE ASSEMBLY OF THIS PRODUCT REQUIRES TWO ADULTS.**

P'kolino products meet or exceed US, EU, and Canadian safety standards. REG. NO. PA-27620 (CN)  
P'kolino (pee-ko-lee-no) © 2022 P'kolino, LLC. All Rights Reserved. All New Materials: Pine Wood. FSC certified. Non toxic and VOC free finish. Made in Brazil.  
Questions or comments? Please email: [customer-care@pkolino.com](mailto:customer-care@pkolino.com) Or write to: P'kolino Studio • 7300 NW 35th Ave • Miami, FL 33147, USA. August / 2022



# **WARNING:**

## **ADULT ASSEMBLY REQUIRED.**

**Product must be assembled by an adult before use.**

After assembly has been completed, all remaining materials and packaging are to be recycled according to the regulations in force and kept out of children's reach. Components left after the assembly are not intended for play.

**Failure to follow these warnings and the assembly instructions could result in serious injury or death.**



# **WARNING:**

## **California Proposition 65**

**This product can expose you to chemicals including wood dust, which is known to the State of California to cause cancer and birth defects or other reproductive harm. For more information, go to [www.p65warnings.ca.gov](http://www.p65warnings.ca.gov).**

# This Box Contains:

Casita Desk Parts:

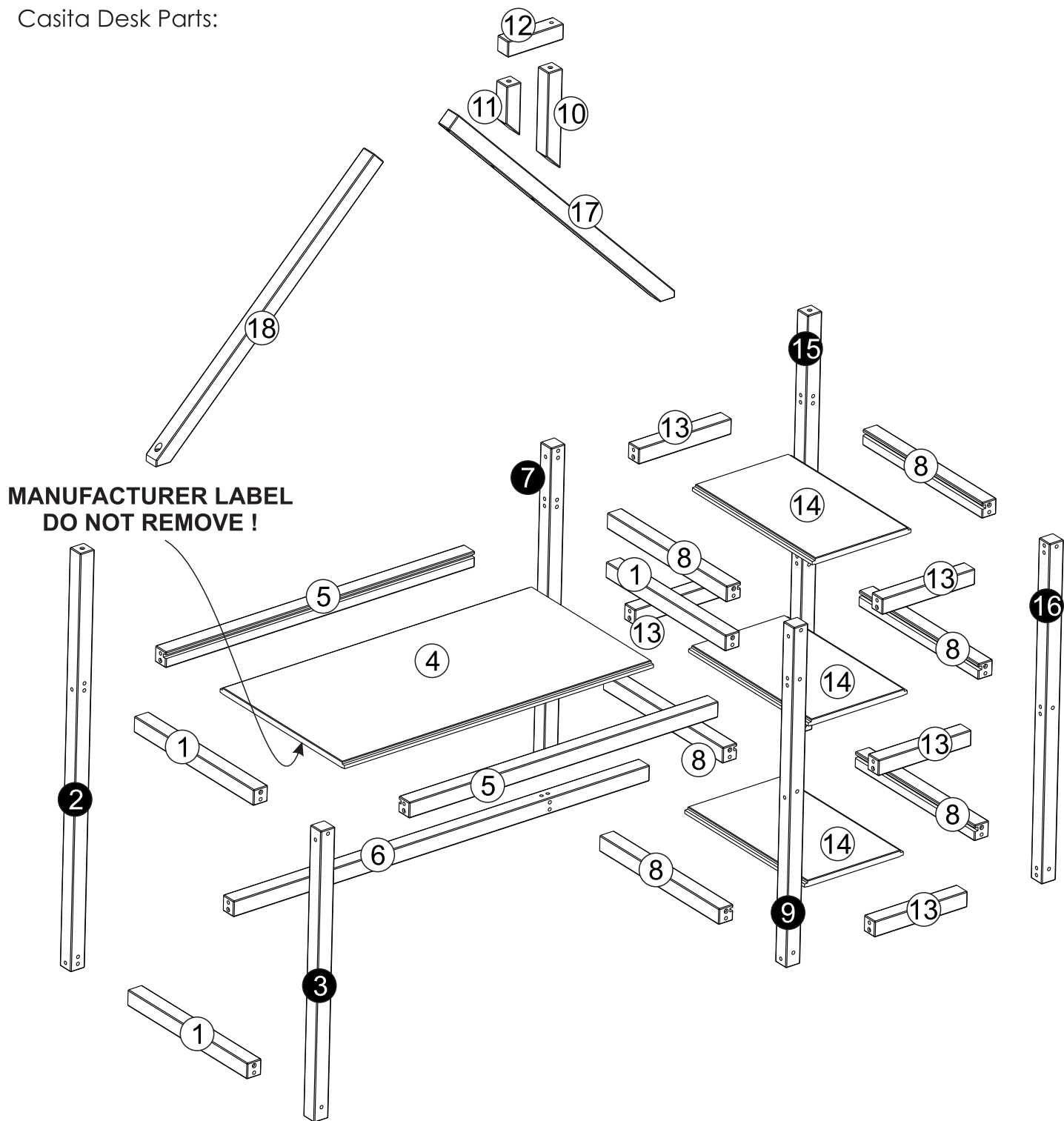

### Tools required

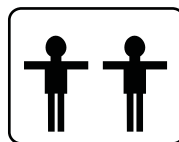
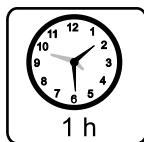
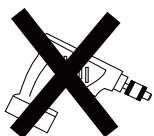
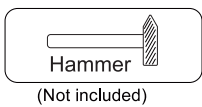
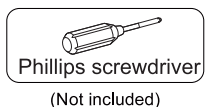

**You will need a Phillips head screwdriver and a hammer**

P'kolino products meet or exceed US, EU, and Canadian safety standards. REG. NO. PA-27620 (CN)

P'kolino (pee-ko-lee-no) © 2022 P'kolino, LLC. All Rights Reserved. All New Materials: Pine Wood. FSC certified. Non toxic and VOC free finish. Made in Brazil.

Questions or comments? Please email: [customer@pkolino.com](mailto:customer@pkolino.com) Or write to: P'kolino Studio • 7300 NW 35th Ave • Miami, FL 33147, USA. August / 2022

Identify the size and type of hardware using the illustration below:

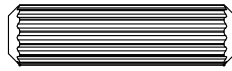

**35** - Wooden dowels  
1  $\frac{3}{16}$ " (8 x 30mm) (A)

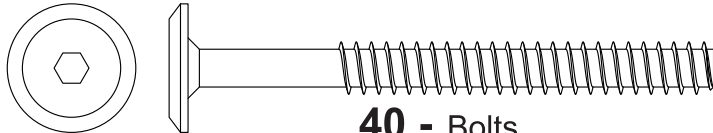

**40** - Bolts  
2  $\frac{3}{4}$ " (7 x 70mm) (B)

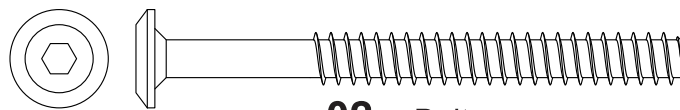

**02** - Bolts  
2  $\frac{3}{4}$ " (7 x 70mm) (C)

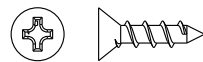

**06** - Screws  
 $\frac{9}{16}$ " (3,5 x 14mm) (D)

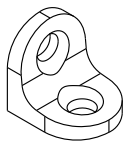

**02** - Corner Plate (E)

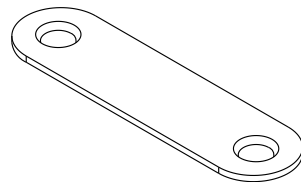



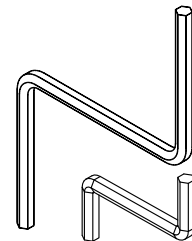

**01** - Metal Plate (F)

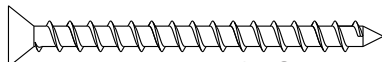

**02** - Allen wrench (G)

## Tipping Restraint Hardware

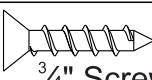
<b>W</b>  Qty <b>01</b>	<b>X</b>  Qty <b>02</b>	 Qty <b>02</b>
<b>Y</b>  Qty <b>02</b>	<b>Z</b>  Qty <b>02</b>	 Qty <b>02</b>

### FOR MISSING PARTS OR HARDWARE:

DO NOT CONTACT THE STORE WHERE YOU MADE YOUR PURCHASE.

Please contact the manufacturer directly at [customercare@pkolino.com](mailto:customercare@pkolino.com) or 888-403-8992. For customer service cases involving hardware please provide the part number.

# Assembly Instructions

## Step 1

Insert 3 wooden dowels (A) into the holes, as shown in the diagram.

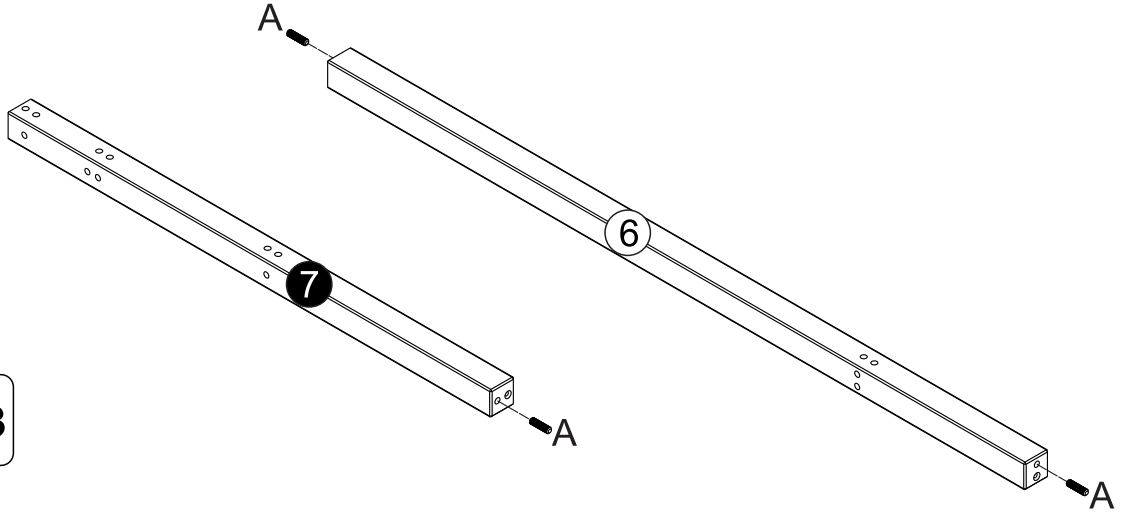
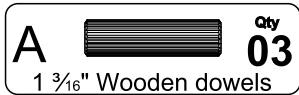
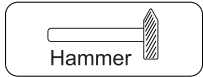

## Step 2

Attach part 7 on to part 6, with 1 bolt (B) using 1 Allen wrench (G).



PLEASE ASSEMBLE  
ON THE GROUND

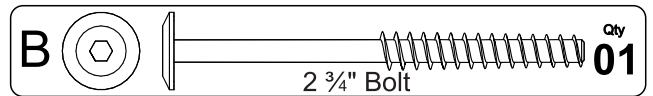
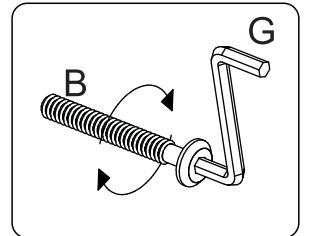
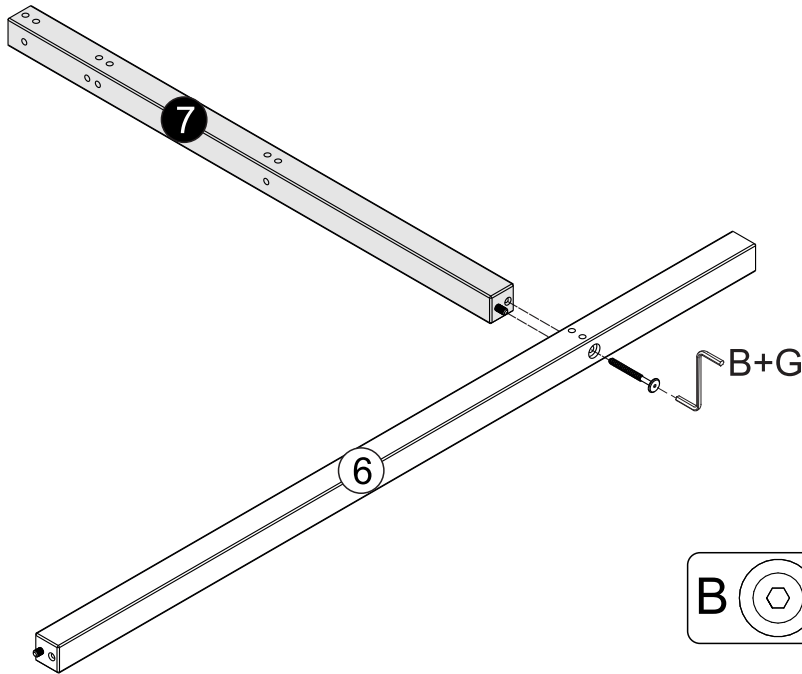

## Step 3

Insert 4 wooden dowels (A) into the holes, as shown in the diagram.



PLEASE ASSEMBLE  
ON THE GROUND

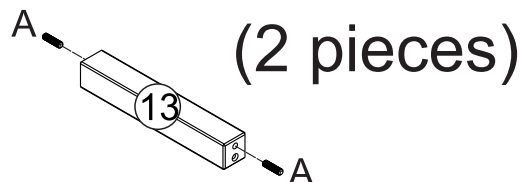
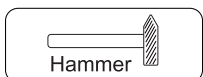

## Step 4

Attach parts **13** on to part **7**, with 2 bolts (**B**) using 1 Allen wrench (**G**).



PLEASE ASSEMBLE  
ON THE GROUND

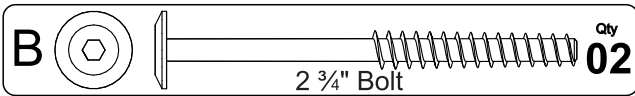
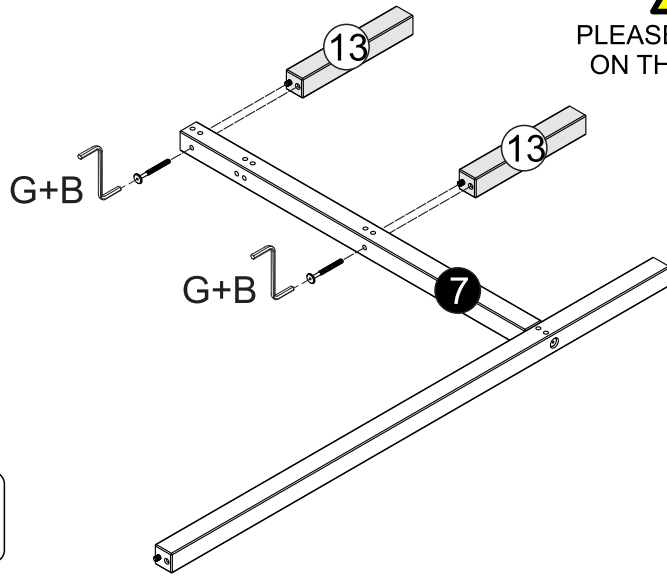
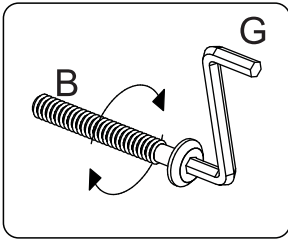

## Step 5

Attach part **15** on to parts **13** and **6**, with 3 bolts (**B**) using 1 Allen wrench (**G**).



PLEASE ASSEMBLE  
ON THE GROUND

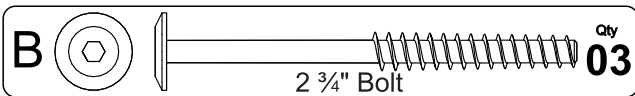
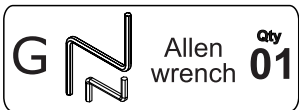
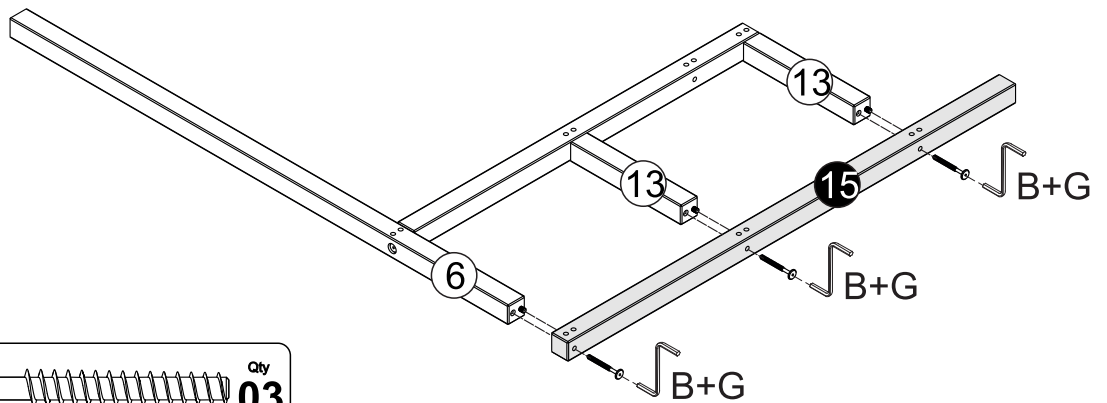
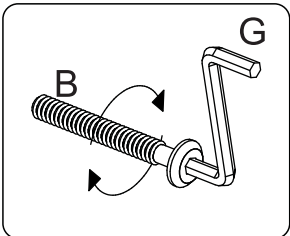

## Step 6

Insert 8 wooden dowels (**A**) into the holes, as shown in the diagram.



PLEASE ASSEMBLE  
ON THE GROUND

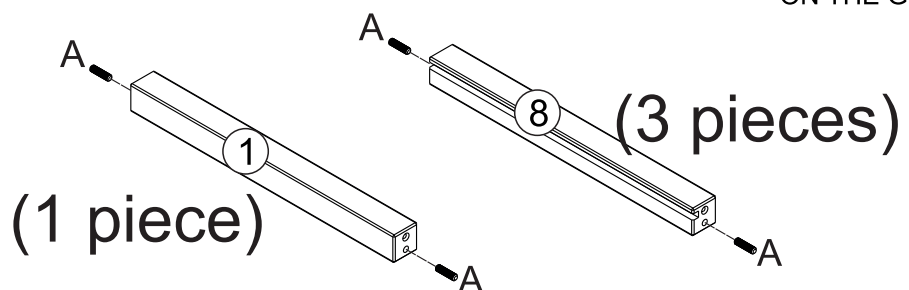
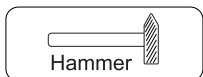

# Assembly Instructions

## Step 7

Attach parts **8** and **1** on to parts **7** and **6**, with 4 bolts (**B**) using 1 Allen wrench (**G**).

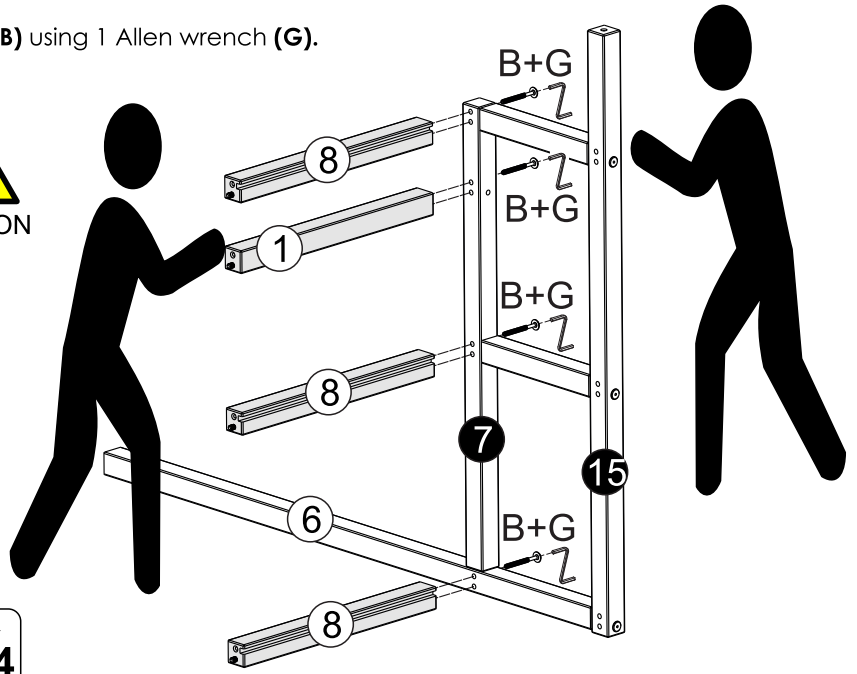
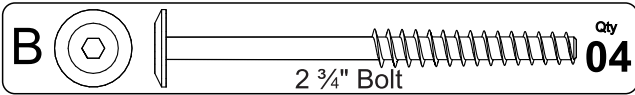
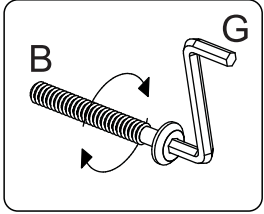
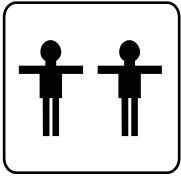

## Step 8

### Right Side

Insert 6 wooden dowels (**A**) into the holes, as shown in the diagram.

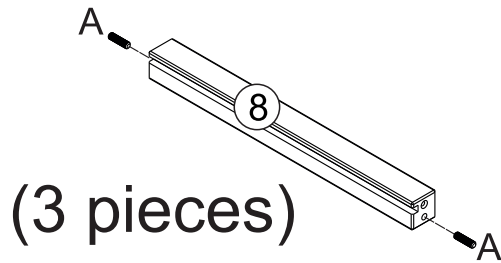
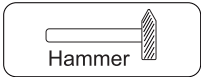

## Step 9

Attach parts **8** on to part **15**, with 3 bolts (**B**) using 1 Allen wrench (**G**).

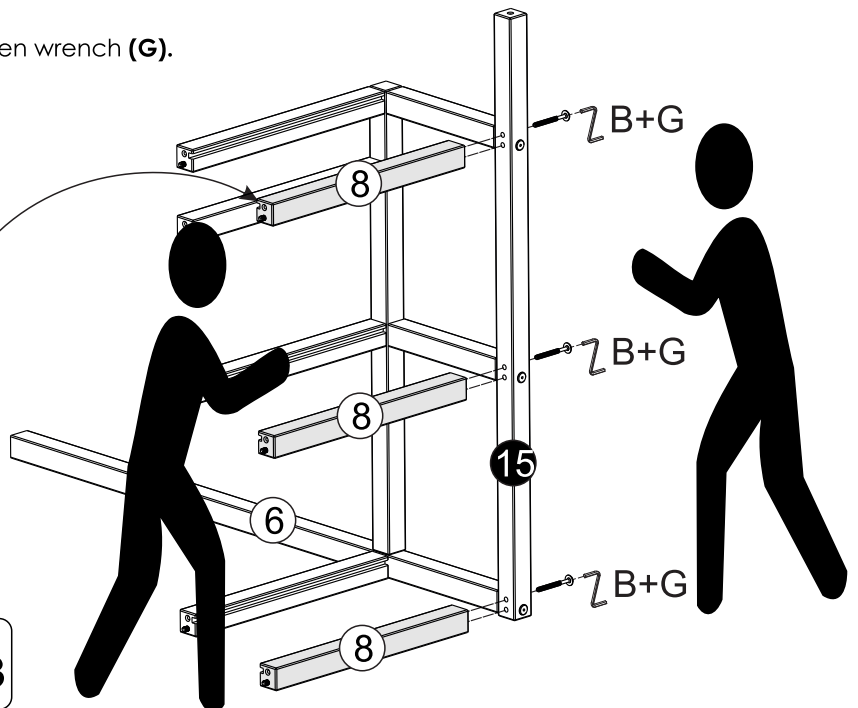
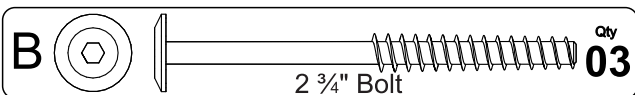
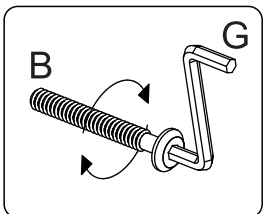
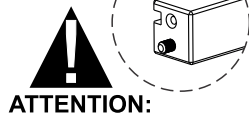
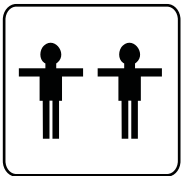

# Assembly Instructions

## Step 10

Insert parts **14** between parts **8**.

  
PLEASE ASSEMBLE  
ON THE GROUND

  
ATTENTION:

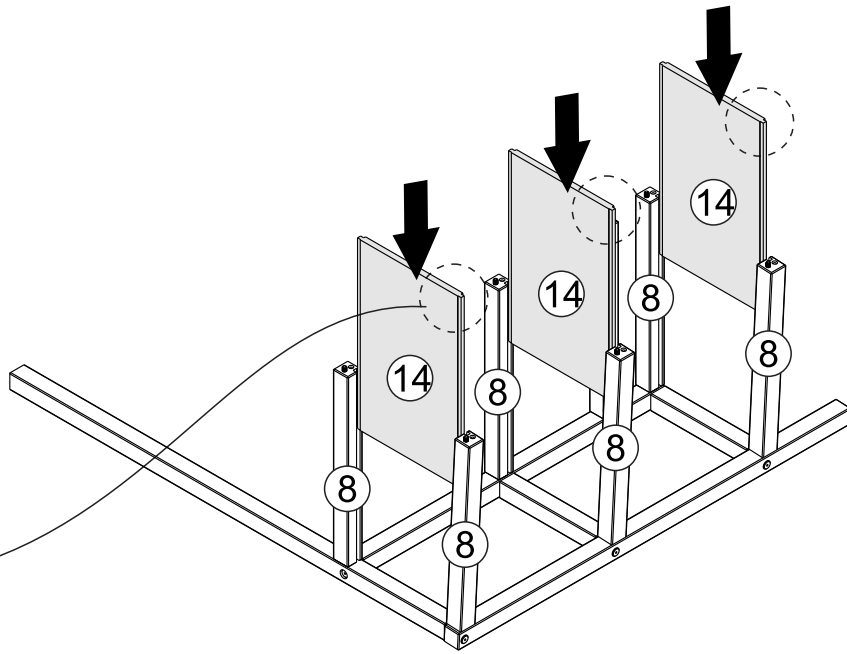

## Step 11

Insert 6 wooden dowels (**A**) into the holes, as shown in the diagram.

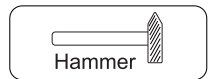
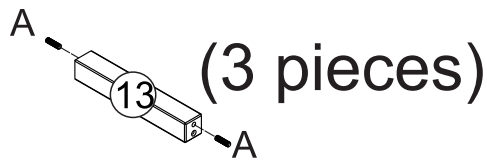

## Step 12

1 - Attach parts **13** on to part **16**, with 3 bolts (**B**) using 1 Allen wrench (**G**).

2 - Attach part **9** on to parts **13**, with 3 bolts (**B**) using 1 Allen wrench (**G**).

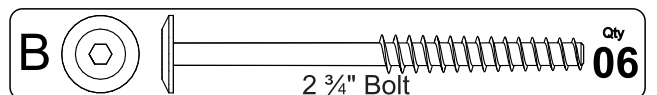
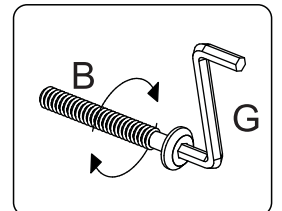
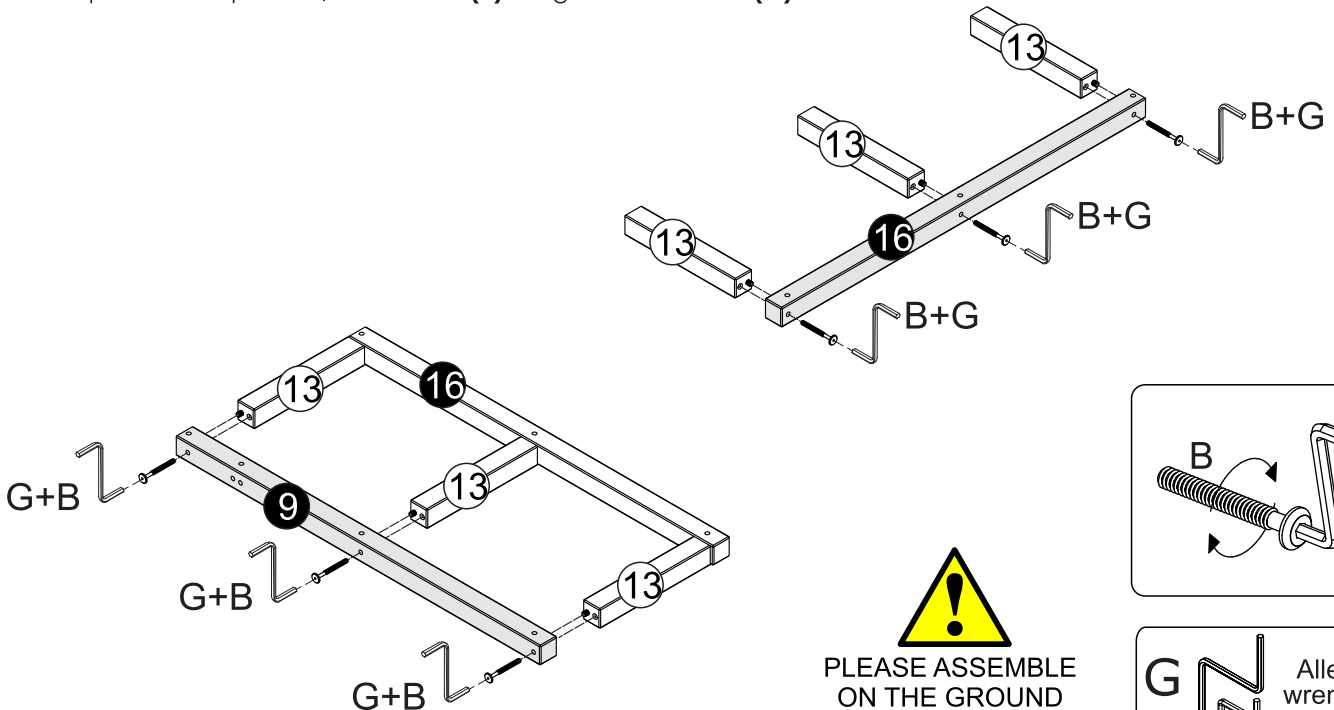



# Assembly Instructions

## Step 13

Attach parts **16** and **9**, on to parts **8** and **1**, with 7 bolts (**B**) using 1 Allen wrench (**G**).



PLEASE ASSEMBLE  
ON THE GROUND

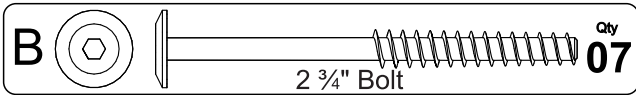
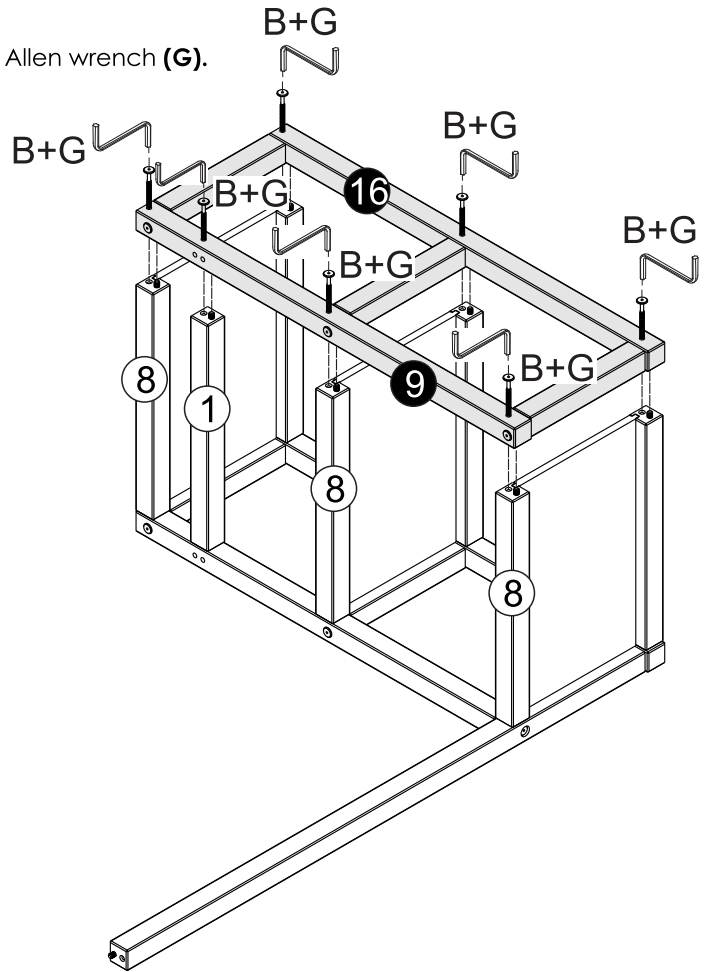
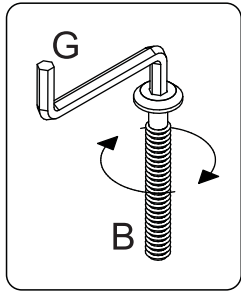

## Step 14

Insert 4 wooden dowels (**A**) into the holes, as shown in the diagram.

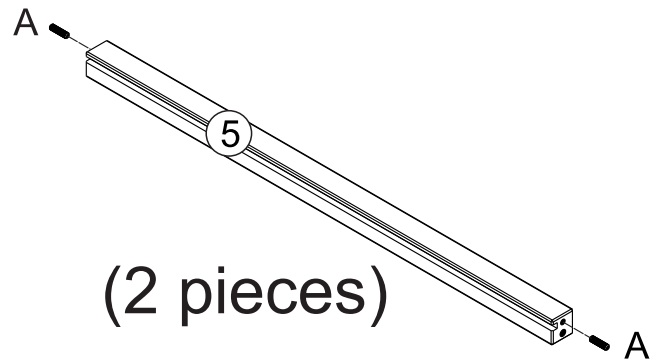
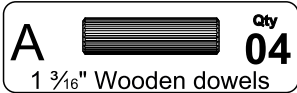
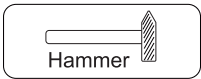

## Step 15

Attach 2 corner plate (**E**) on the part **4**, with 2 screws (**D**) using Phillips Screwdriver.

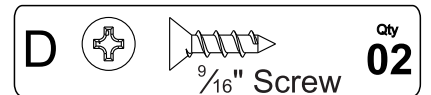
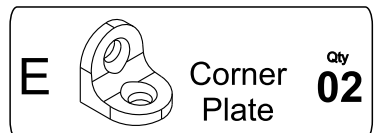
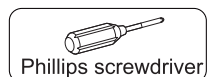
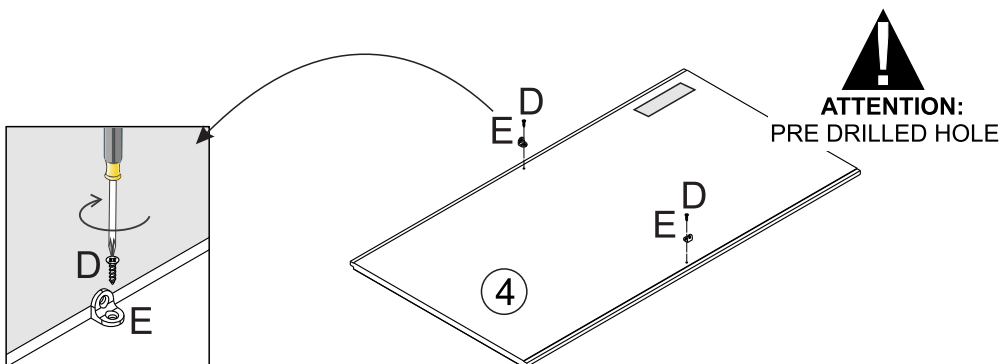

# Assembly Instructions

## Step 16

Attach parts **5** on to parts **7** and **9**, with 2 bolts (**B**) using 1 Allen wrench (**G**).

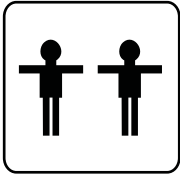

  
**ATTENTION:**

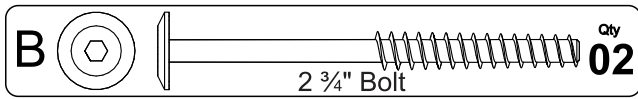
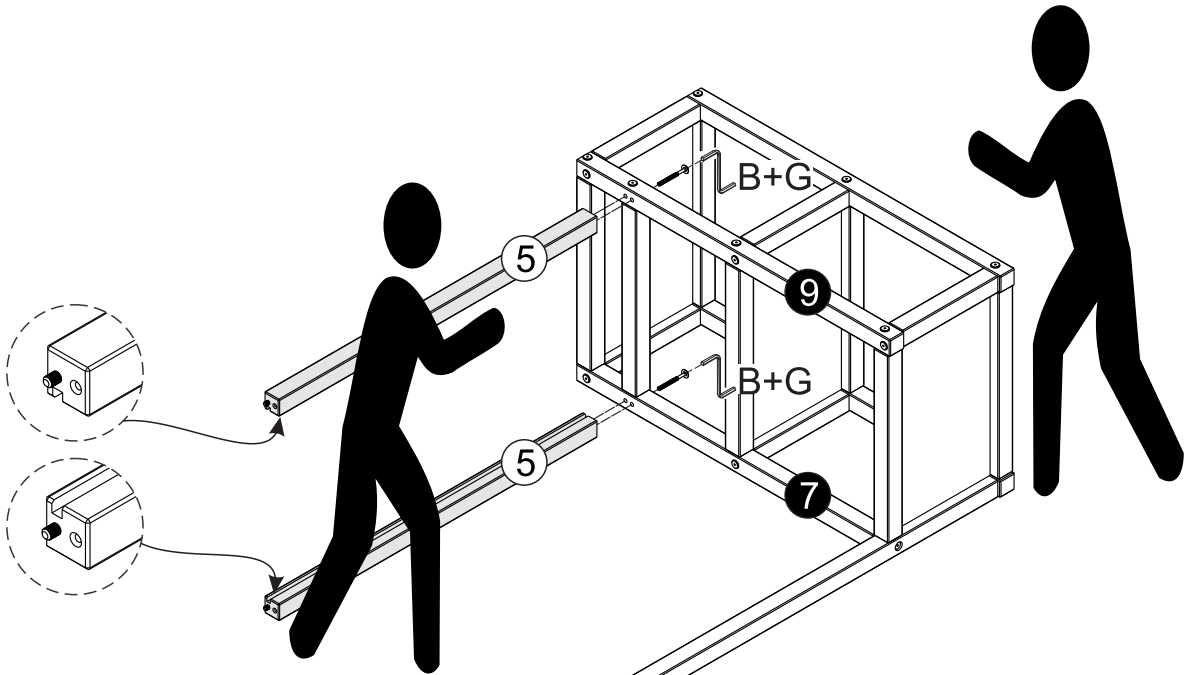

**PLEASE ASSEMBLE  
ON THE GROUND**

## Step 17

Insert part **4** between parts **5**.

**MANUFACTURER LABEL  
UNDERSIDE  
DO NOT REMOVE !**

  
**ATTENTION:**

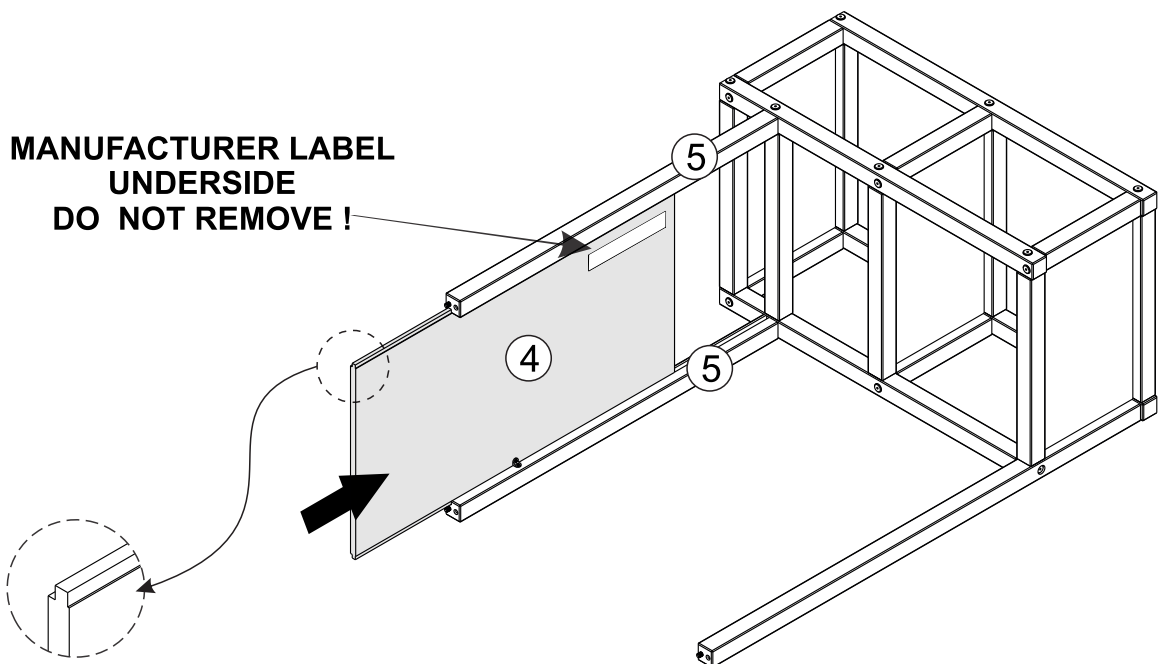

# Assembly Instructions

## Step 18

### Left Side

Insert 4 wooden dowels (A) into the holes, as shown in the diagram.

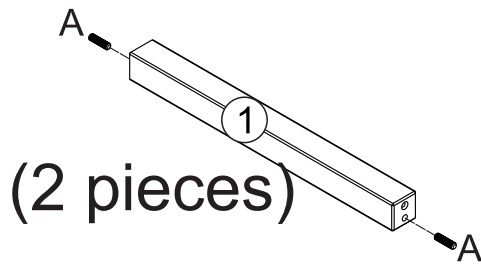
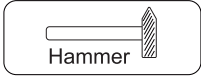

## Step 19

### Left Side

- 1 - Attach parts 1 on to part 2, with 2 bolts (B) using 1 Allen wrench (G).
- 2 - Attach part 3 on to parts 1, with 2 bolts (B) using 1 Allen wrench (G).



PLEASE ASSEMBLE  
ON THE GROUND

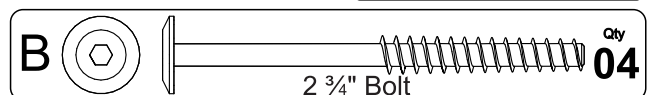
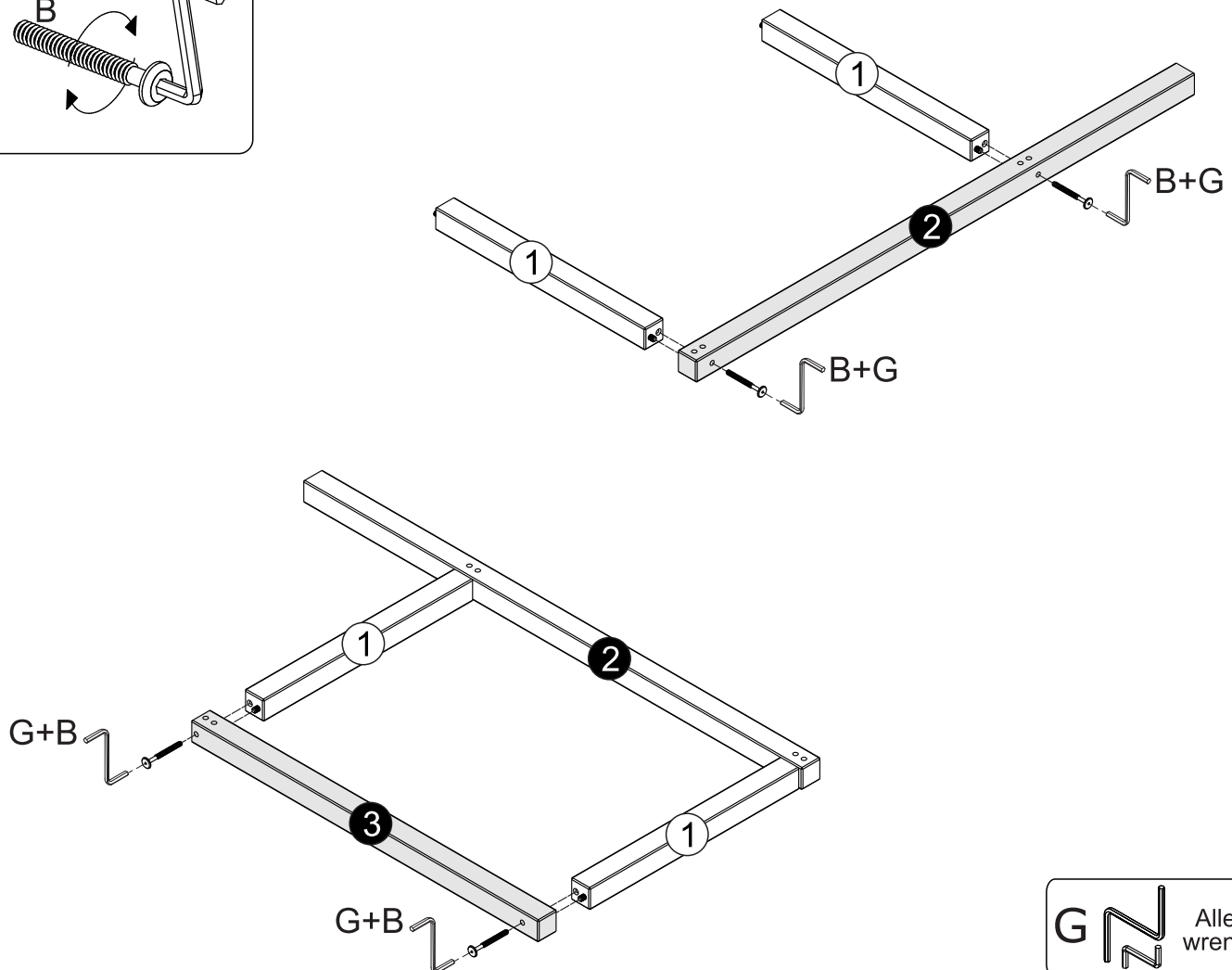
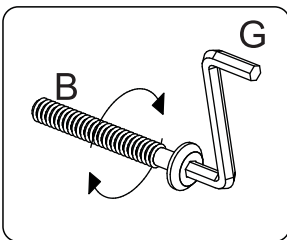

# Assembly Instructions

## Step 20

Attach parts **3** and **2** on to parts **5** and **6**, with 3 bolts (**B**) using 1 Allen wrench (**G**).

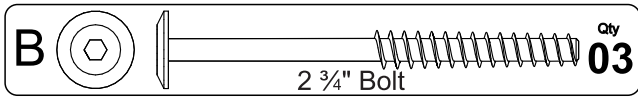
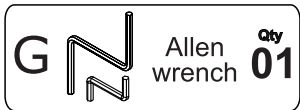
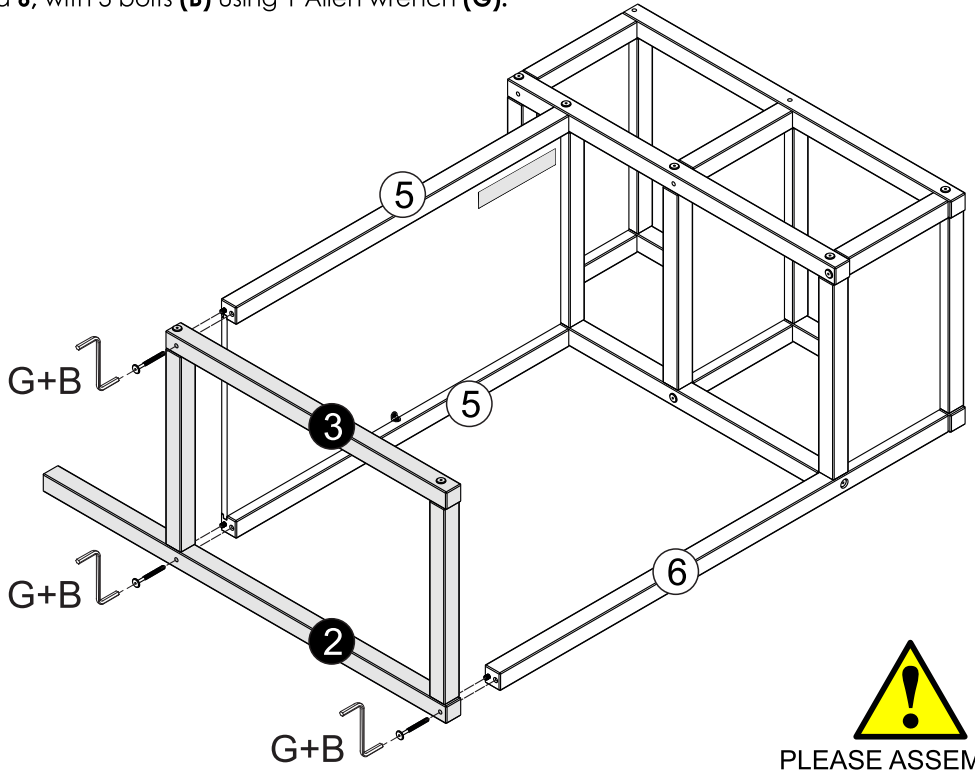
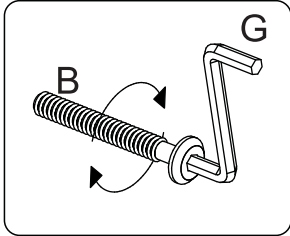

PLEASE ASSEMBLE  
ON THE GROUND

## Step 21

Attach 2 screws (**D**) on to corner plate and parts **5**, using 1 Phillips Screwdriver.

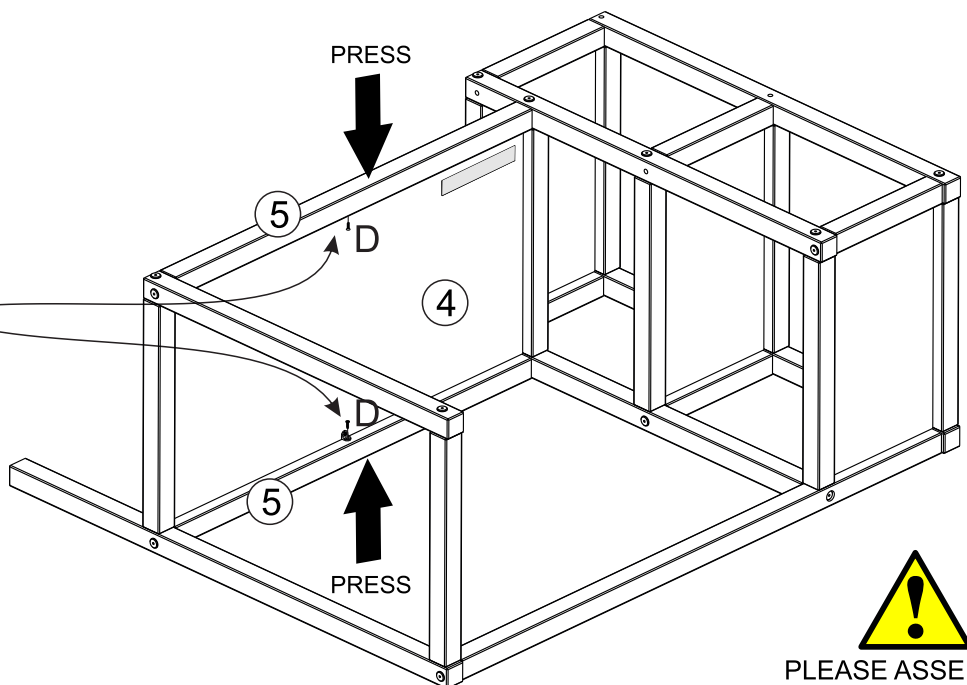
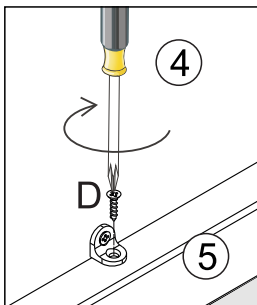

PLEASE ASSEMBLE  
ON THE GROUND

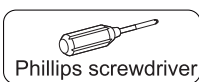
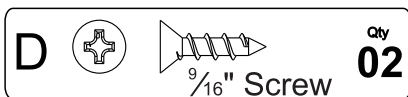

# Assembly Instructions

## Step 22

Attach part **18** on to part **17**, with 1 bolt (**B**), using 1 Allen wrench (**G**).



PLEASE ASSEMBLE  
ON THE GROUND

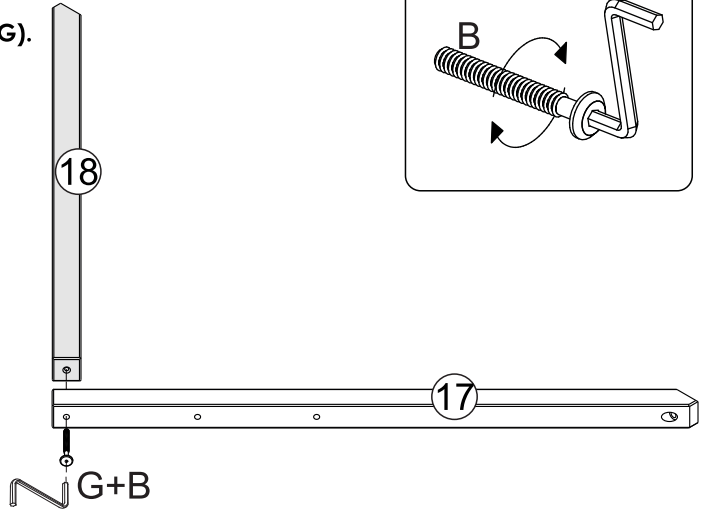
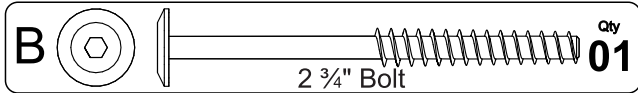
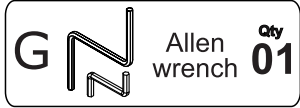

## Step 23

Attach part **12** on to parts **11** and **10**, with 2 bolts (**B**) using 1 Allen wrench (**G**).



PLEASE ASSEMBLE  
ON THE GROUND

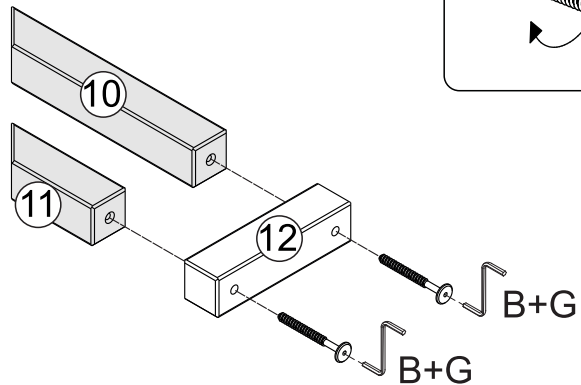
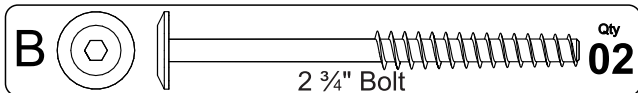
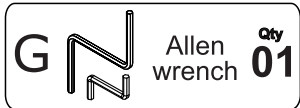

## Step 24

Attach part **17** on the parts **11** and **10**, with 2 bolts (**B**) using 1 Allen wrench (**G**).



PLEASE ASSEMBLE  
ON THE GROUND

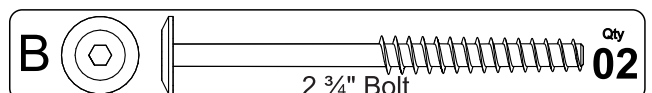
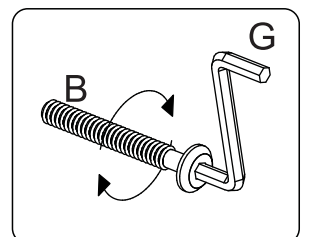
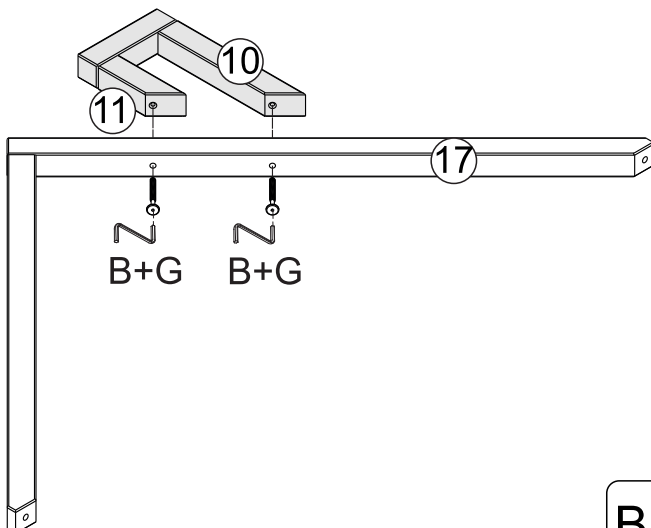

# Assembly Instructions

## Step 25

Attach parts **17** and **18** on to parts **15** and **2**, with 2 bolts **(C)** using 1 Allen wrench **(G)**.



### ATTENTION:

This step you can choose which side the chimney will be assembled, on the right or on the left side.

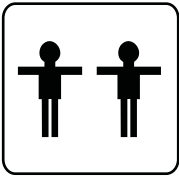

OPTIONAL  
CHIMNEY  
RIGHT SIDE

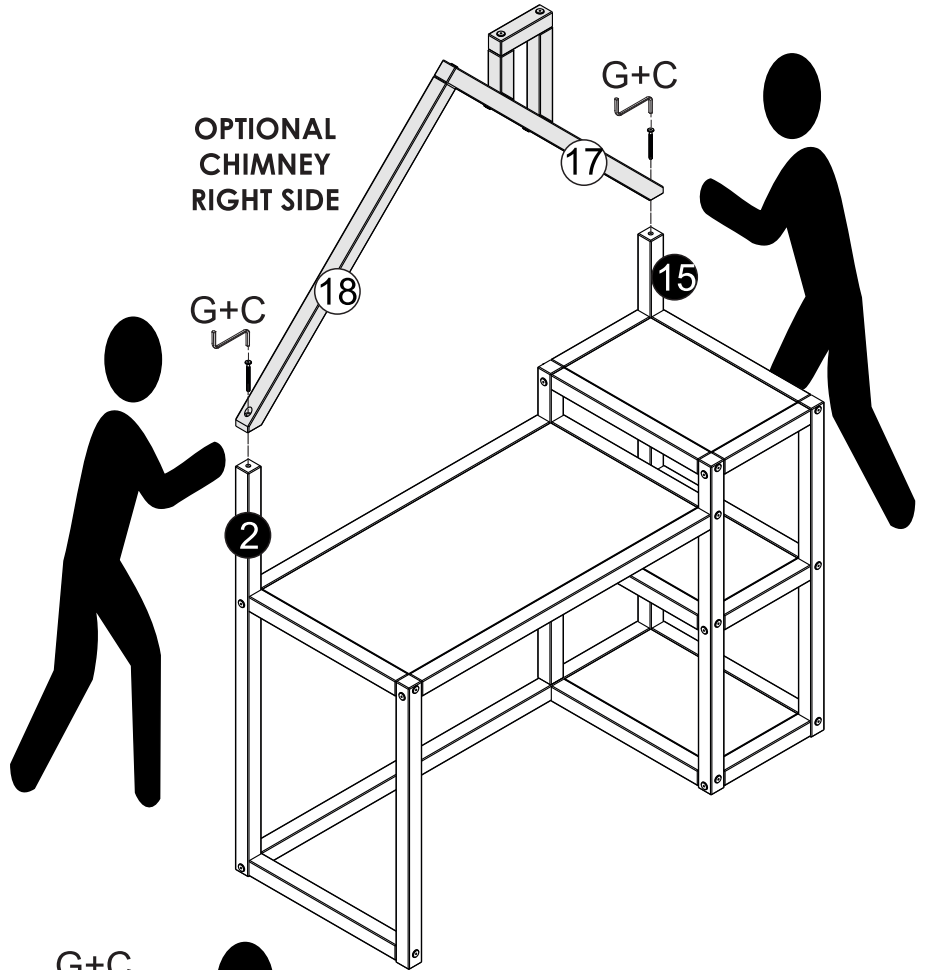

OPTIONAL  
CHIMNEY  
LEFT SIDE

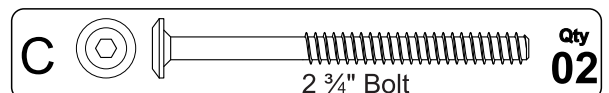
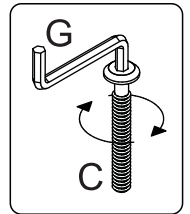
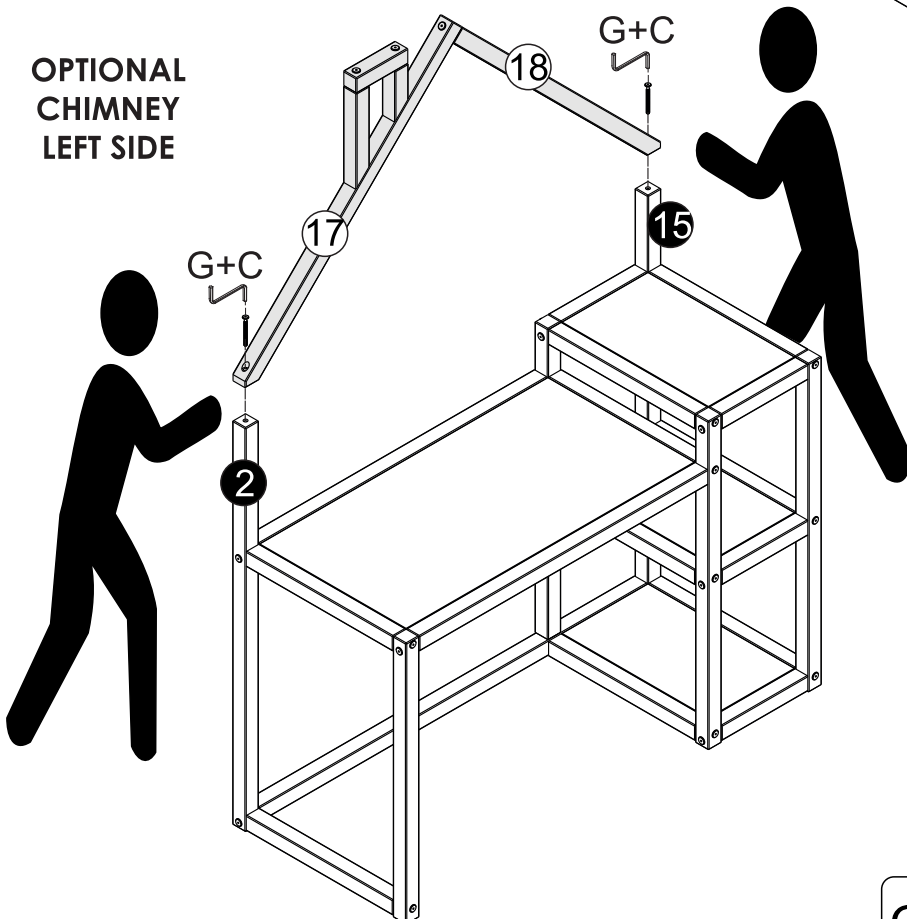

# Assembly Instructions

## Step 26

- 1 - Insert the metal plate (F) between parts 17 and 18.
- 2 - Attach the metal plate (F) with 2 screws (D) using 1 Phillips Screwdriver.

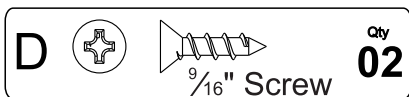
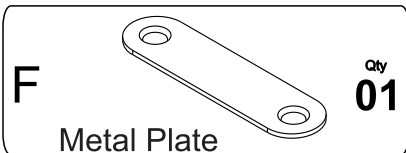
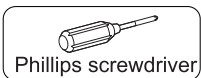
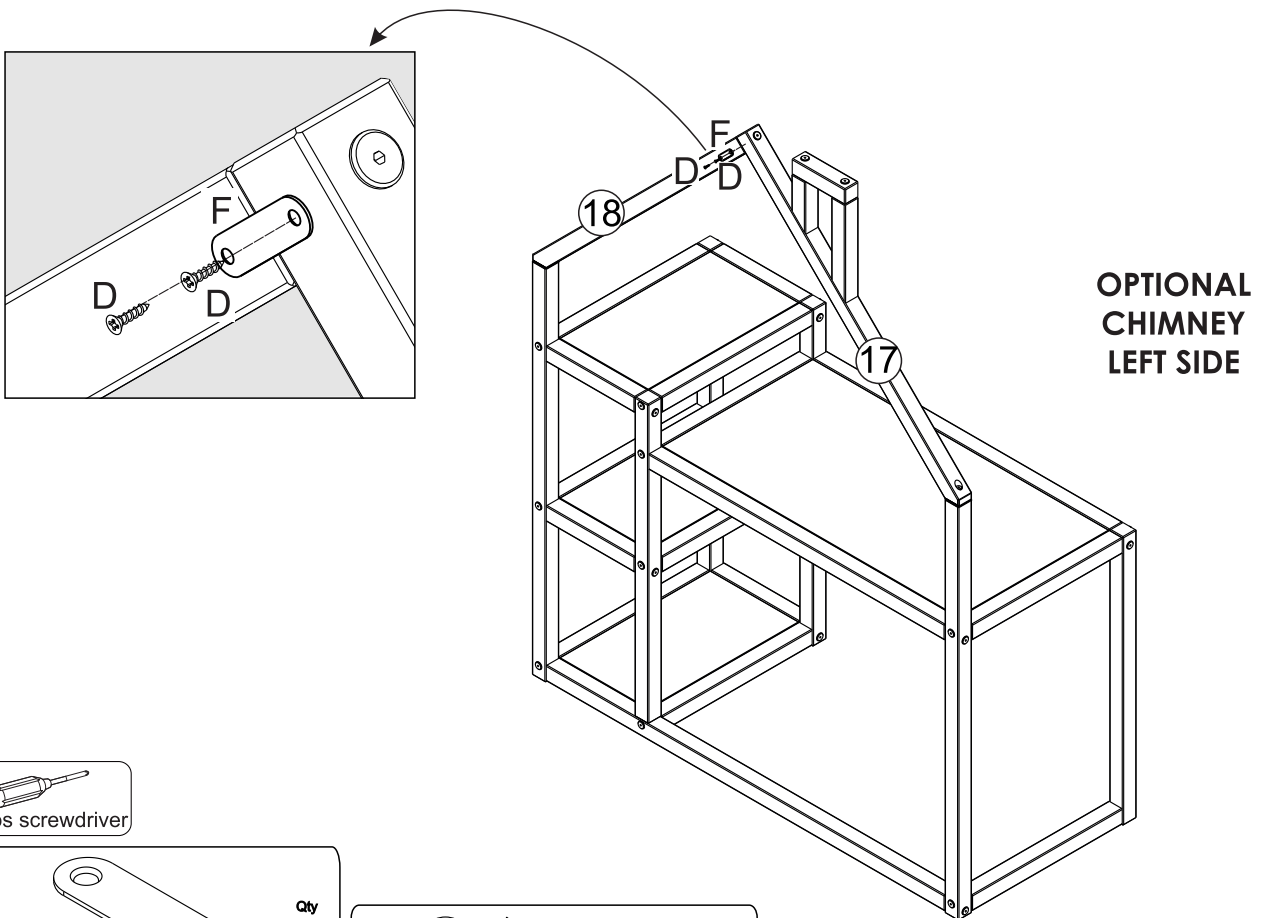
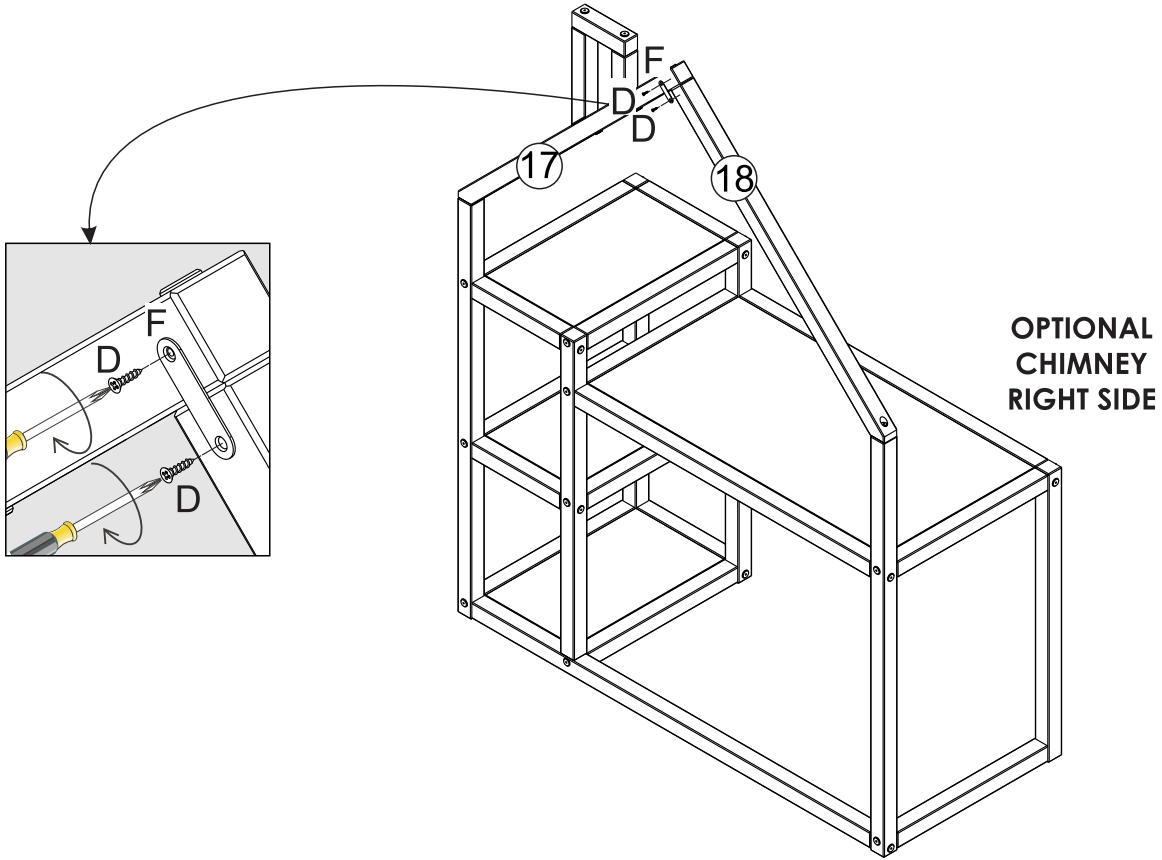

# Assembly Instructions

## Step 27

- 1 - Attach the Plastic Bracket (Y) on the wall stud with 2 screws (X), using 1 Phillips Screwdriver.
- 2 - Attach the Plastic Bracket (Y) on the bookcase with 2 screws (Z), using 1 Phillips Screwdriver.

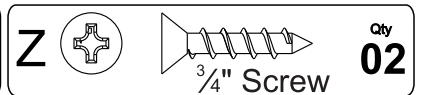
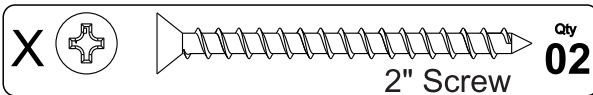
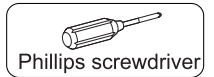
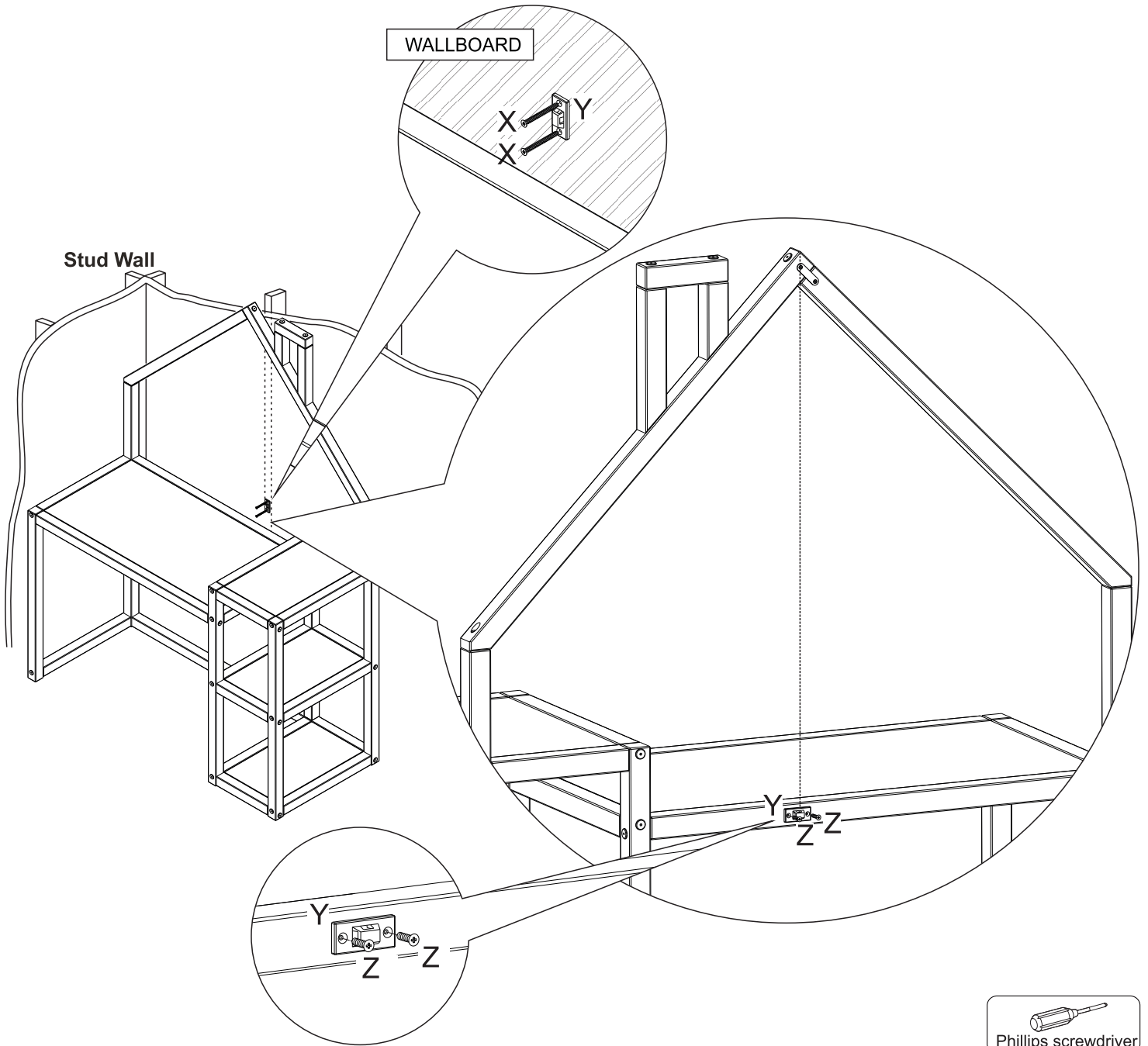

## Step 28

Using the Nylon Strap (W) attach the bookcase to the wall stud.

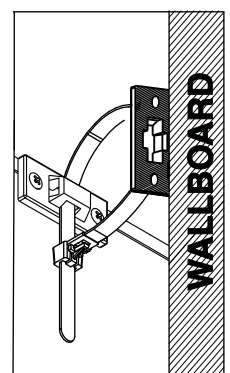
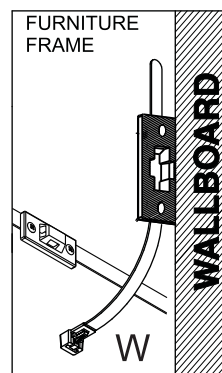
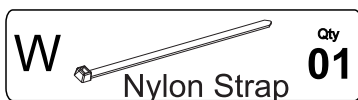



# WARNING

Serious or fatal crushing injuries can occur from furniture tip over. To help prevent tip over:

- \* Place heaviest items in the lowest drawers.
- \* Do not set TVs or other heavy objects on top of this product.
- \* Never allow children to climb or hang on drawers, doors, or shelves.
- \* Never open more than one drawer at a time.

Use of tip-over restraints may only reduce, but not eliminate, the risk of tip over.

## Tipping Restraint Instructions

### Step 1

- \* This tip restraint must be attached to a Wall Stud using the 2" screw (X) enclosed.
- \* When properly installed, this hardware can provide protection against the unexpected tipping of furniture.
- \* Attach one of the mounting brackets (Y) securely to the back top edge of the unit using the short screw (Z).
- \* Place the other bracket on the wall over a wall stud and 2 inches below the mounting bracket secured to the back of your unit. Attach to the wall stud using the 2" screw (X) provided, through the bracket hole.
- \* Place the unit to the bracket on the back edge of unit is in line with the bracket on the wall.

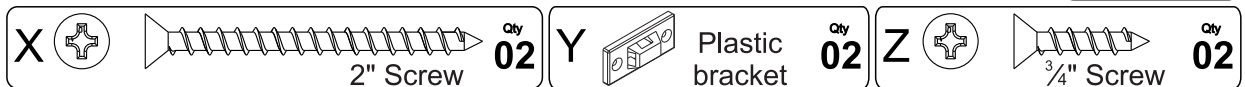
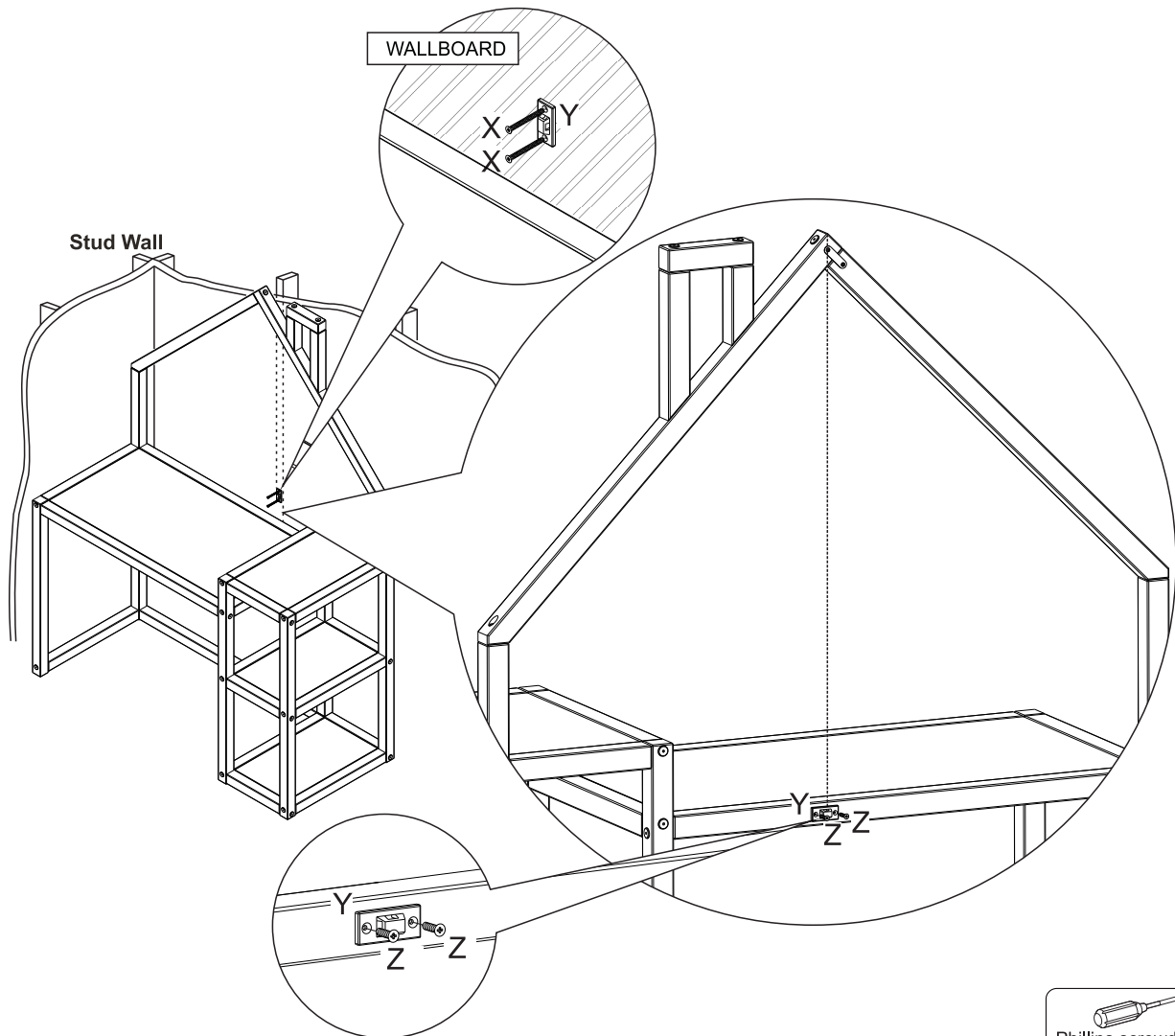

### Step 2

- \* Lace the end of the nylon restraint strap (W) through each bracket. Bring both ends together and slide the beaded end of the strap through the keyhole shaped slot on the other end. Pull down on the beaded end until it snap-locks into the keyhole.
- \* Check to make sure the strap is securely laced and locked to the brackets.

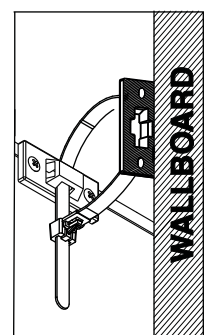
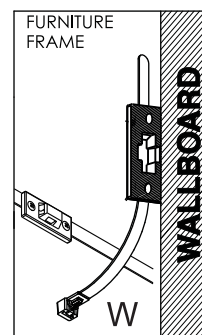

## **Return Policy:**

- For products purchased through our retail partners please contact them for resolution prior to contacting P'kolino.
- At P'kolino it is our commitment to improve play at home with products that are playfully-stylish and functionally-smart. That means, we want you and the child(ren) to love the way our products look and work. If within 10 days of receipt or your product you are not satisfied you may return it for a refund of the merchandise value.
- Our products and packaging have been designed to withstand standard delivery methods, however, please inspect your product upon receipt for damage to the packaging as products damaged during shipping are subject to exchange or refund. If product has been visibly damaged it is recommended that you refuse the delivery by the carrier. Notify us of the shipment rejection and upon receipt of the rejected shipment we will send you a replacement at no charge.
- To return your product, contact the retailer your purchased your product from. For products with visible wear or that are not properly repackaged will incur a restocking fee of 10%. Please follow assembly, use and care instructions carefully as we will not accept returns on products damaged due to improper assembly, altered or modified products, or on items damaged from normal, excessive or unintended use. Return shipping expenses, unless otherwise specifically stated by P'kolino, will be the customers expense.
- If you have questions regarding our policy please contact us at [customercare@pkolino.com](mailto:customercare@pkolino.com) or 888-403-8992.

## **Warranty:**

- P'kolino products are guaranteed to be free from defects in material and workmanship under normal and intended use for a period of 30 days from the date of your purchase.

## **Replacement/Credit:**

- If our product fails to meet our warranty during the warranty period, we will, at our option, replace the product or provide you with a replacement of comparable value.

## **What Our Limited Warranty Does Not Cover:**

- We offer this limited warranty only when the product is used by the original end-user customer. We offer no other warranty. Additionally, while our warranty is excellent, there are other limits to it. We offer NO WARRANTY in cases of damage in transit, inadequate care, abuse, abnormal use, misuse, accidents, normal wear and tear, damage due to environmental or natural elements, failure to follow product instructions, immersion in water (except for products specifically identified by us in writing as intended for water use), or improper storage or maintenance of the products.

## **Limitation on Damages:**

- IN NO EVENT SHALL P'KOLINO, LLC BE LIABLE FOR INCIDENTAL, COMPENSATORY, PUNITIVE, CONSEQUENTIAL, INDIRECT, SPECIAL OR OTHER DAMAGES. OUR AGGREGATE LIABILITY WITH RESPECT TO DEFECTIVE PRODUCTS IS LIMITED TO THE MONIES PAID TO US FOR THE DEFECTIVE GOOD.

Some states and countries do not allow the exclusion or limitation of incidental, consequential or other damages, so the above limitation or exclusion may not apply to you. This warranty gives you specific legal rights, and you may also have other rights which vary based on state, province or country.

## **Contact Information**

Please feel free to contact us at the address listed below

P'kolino LLC • 7300 NW 35th Avenue • Miami, FL 33147 • USA

# CARE AND MAINTENANCE:

## **MAINTENANCE:**

- Our furniture is designed to be low maintenance, however misuse, irregular use, or improper assembly can result in product malfunction. Regularly check the stability. If pieces feel loose or wobbly tighten all screws immediately.
- To store, review Assembly Instructions and reverse the steps to disassemble.
- Use only provided hardware to assemble and maintain assembly.

## **CARE:**

- To clean use a soft, lint free rag similar to a cloth diaper and wipe away dust regularly. If necessary dampen cloth slightly with warm water and gently rub away spots. Dry thoroughly.
  - Do not use a bleach solution.
  - Do not submerge or allow to lie in standing water.
  - Do not use a sponge or harsh abrasive.
  - Do not use all purpose cleaners or harsh detergents.
  - Do not use Pine Oil cleaners or abrasive household cleaners.
  - Do not use heat or hot water.

## **ABOUT WOOD AND FINISH:**

This product has been carefully crafted of MDF, solid pine wood and/or pine veneers. These materials derive from plantations, a renewable and well managed forest, therefore, not endangering the environment. The highest quality standards have been implemented to assure a sturdy and reliable product. Due to the natural variances in the graining of wood, you may notice subtle differences in the shading and tone of the color stain, warp, holes, wood knots and also small cracks. This is not a defect. But rather a result of the natural beauty of the wood itself.

**PLEASE REGISTER THIS PRODUCT AT: [WWW.PKOLINO.COM/REGISTER](http://WWW.PKOLINO.COM/REGISTER)**

**California 93120 compliant for formaldehyde Phase 2 TPC-AQCARB-03**