

PUFP Square Floor Boxes

CATALOG #	DESCRIPTION
PUFP-SQ-BR	Brass pop up floor plate assembly, with 15 AMP (TR) duplex power receptacle
PUFP-SQ-BR-GFI	Brass pop up floor plate assembly, with 20 AMP (TR) GFI receptacle
PUFP-SQ-BR-USB	Brass pop up floor plate assembly, with 15 AMP (TR) duplex power/ 2USB receptacle
PUFP-SQ-DB	Dark Bronze pop up floor plate assembly, with 15 AMP (TR) duplex power receptacle
PUFP-SQ-DB-GFI	Dark Bronze pop up floor plate assembly, with 20 AMP (TR) GFI receptacle
PUFP-SQ-DB-USB	Dark Bronze pop up floor plate assembly, with 15 AMP (TR) duplex power/ 2USB receptacle
PUFP-SQ-SS	Stainless Steel pop up floor plate assembly, with 15 AMP (TR) duplex power receptacle
PUFP-SQ-SS-GFI	Stainless Steel pop up floor plate assembly, with 20 AMP (TR) GFI receptacle
PUFP-SQ-SS-USB	Stainless Steel pop up floor plate assembly, with 15 AMP (TR) duplex power/ 2USB receptacle

▶▶▶ All floor plates 4 3/4 W x 4 3/4 L x 3 5/8 H and include PUFP-WB box

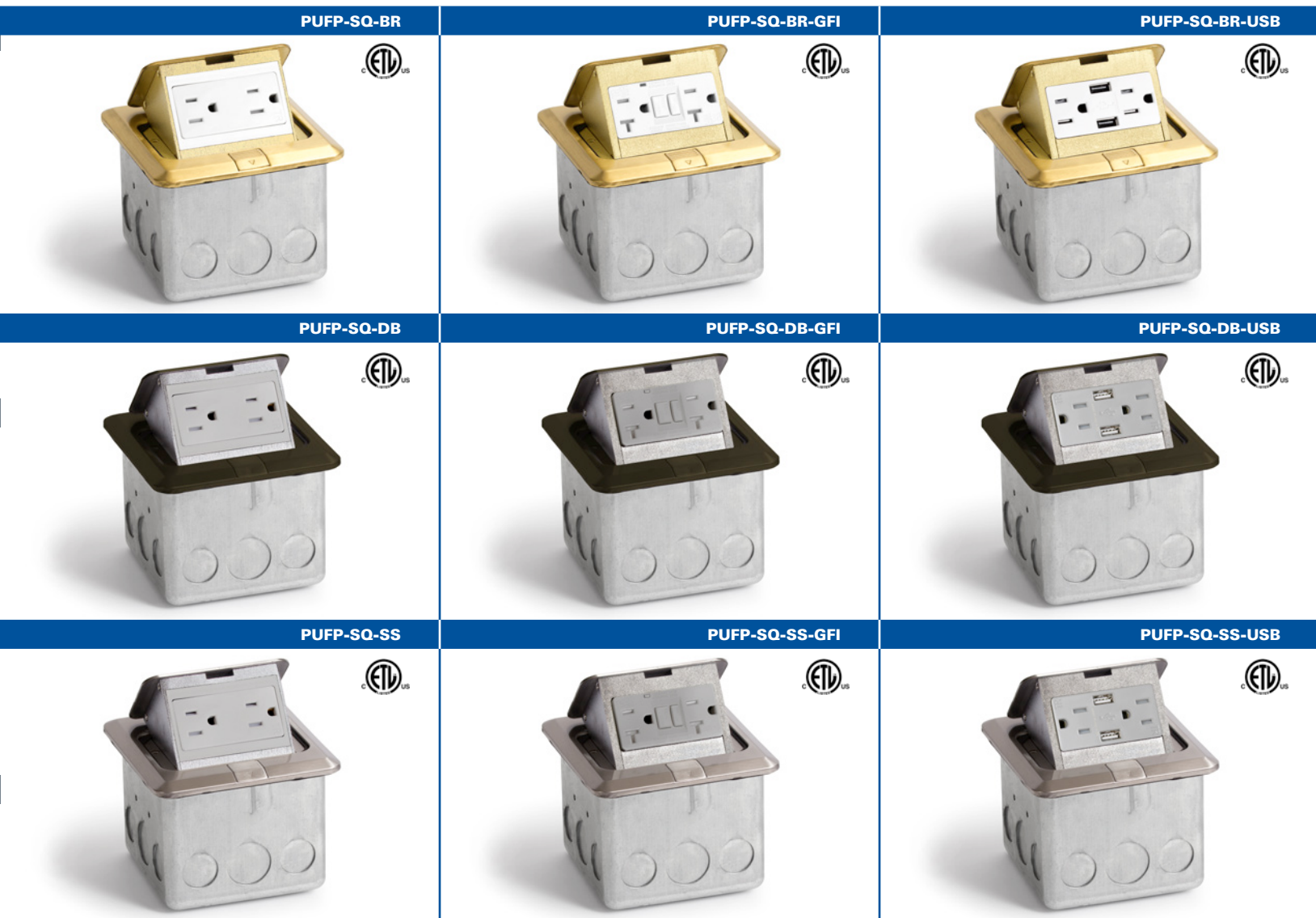

FEATURES & BENEFITS

- **UL recognized** 498, 514A, 943, 1059, and NEC 210.52(C). **CUL recognized** 22.2 #'s 42, 158, and 18.1-04.
- **Receptacles:** GFI – UL Listed E473428
2USB – UL Listed E491706
- All PUFP styles supplied with **tamper resistant** receptacles
- **Pops out** when in use
- **Hides in the box** when not in use
- For **residential or commercial** applications
- Installs in **wood floors**
- **Scrub water tight** construction



Conforms to UL STD.514A and 498;
 Certified to CSA STD.C22.2.; No.18.1-04 and
 42-M1984; LEW ELECTRIC FITTINGS CO

PUFP Covers and Boxes

CATALOG #	DESCRIPTION
PUFP-B	6" Brass pop up floor plate with 15 AMP (TR) GFI receptacle
PUFP-BC	6" Brass pop up floor plate with 6 port Comm./Data device (max 3 CAT6 jacks)
PUFP-BD	6" Brass pop up floor plate with 15 AMP (TR) decora receptacle
PUFP-S	6" Stainless Steel pop up floor plate with 15 AMP (TR) GFI receptacle
PUFP-SC	6" Stainless Steel pop up floor plate with 6 port Comm./Data device (max 3 CAT6 jacks)
PUFP-SD	6" Stainless Steel pop up floor plate with 15 AMP (TR) decora receptacle
PUFP-LRA	Leveling ring for PUFP plates

CATALOG #	DESCRIPTION	DIMENSIONS	
		A	B
PUFP-HB	Concrete box for PUFP plates	4 5/16"	3 1/4"
PUFP-PB	Poly-Box for PUFP series covers	4 7/8"	4 3/4"
PUFP-WB	Wood floor box for PUFP plates	3 7/8"	3 1/8"
FB	PVC floor box (must use in conjunction with PUFP-LRA to mount cover); box UL listed #514C	5"	6"

PUFP-B



PUFP-BC



PUFP-BD



FEATURES & BENEFITS

- **UL recognized** 498, 514A, 943, 1059, and NEC 210.52(C).
CUL recognized 22.2 #'s 42, 158, and 18.1-04.
- **Pops out** when in use
- **Hides in the box** when not in use
- For **residential or commercial** applications
- Installs in **concrete or wood** floors
- **Scrub water tight** construction
- All PUFP style supplied with **tamper resistant** receptacles
- **Receptacles:** GFI – UL Listed E473428
Decora – UL Listed E309821

PUFP-S



PUFP-SC



PUFP-SD



Conforms to UL STD.514A and 498;
Certified to CSA STD.C22.2.; No.18.1-04 and
42-M1984; LEW ELECTRIC FITTINGS CO

PUFP-LRA



PUFP-HB

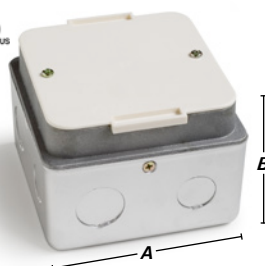

PUFP-PB



PUFP-WB



FB

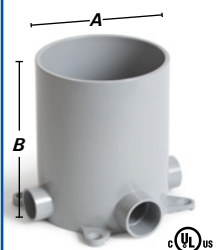

RCFB Boxes and Covers (Subfloor installation)

»»»» For Replacement Plugs, see page 49

RCFB-1

RCFB-1: Recessed hybrid one gang floor box (Standard duplex receptacle only, cannot accommodate decora/GFI style receptacle)



Includes One RRP-2-PQ Quad Port

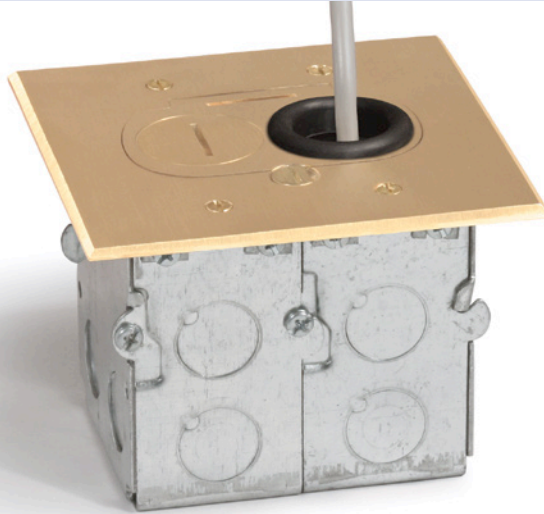

Width	5"	Height	4"
Length	5"	Interior Capacity	36 Cu. In.



Finish Options

 Brass » RCFB-1	 Aluminum » RCFB-1-A	 Dark Bronze » RCFB-1-DB
--	---	---

REPLACEMENT COVER FOR RCFB-1



Replacement Cover

 Brass » RCFB-1-BP	 Aluminum » RCFB-1-AP
 Dark Bronze » RCFB-1-DBP	

RCFB-2

RCFB-2: Recessed hybrid two gang floor box (Standard duplex receptacle only, cannot accommodate decora/GFI style receptacle)



Includes One RRP-2-PQ Quad Port

Width	5 1/16"	Height	4"
Length	8 5/8"	Interior Capacity	72 Cu. In.



Finish Options

 Brass » RCFB-2	 Aluminum » RCFB-2-A	 Dark Bronze » RCFB-2-DB
--	---	---

REPLACEMENT COVER FOR RCFB-2



Replacement Cover

 Brass » RCFB-2-BP	 Aluminum » RCFB-2-AP
 Dark Bronze » RCFB-2-DBP	

RCFB-1 & RCFB-2: UL & NEMA

- Box UL #E345966
- Tamper resistant receptacle UL #309821 (duplex)

RCFB-1 & RCFB-2: FEATURES & BENEFITS

- Water tight close up plugs
- Rubber grommets provided for wire protection

Plastic Boxes and Covers (Finished floor installation)

CATALOG #	DESCRIPTION	DIMENSIONS		INTERIOR CAPACITY
		A	B	
PBR-1	Round plastic box with 15 AMP (TR) duplex receptacle* included	4 3/8"	3 1/8"	20 Cu. In.
PBR1-FPA	Round plastic box kit with PBR-FPA Aluminum flip cover & 15 AMP (TR) receptacle*	5 1/16"	3 1/4"	20 Cu. In.
PBR-FPA	Aluminum flip cover for PBR-1	Diameter: 5 1/16"		
PBR1-FPB	Round plastic box kit with PBR-FPB Brass flip cover & 15 AMP (TR) receptacle*	5 1/16"	3 1/4"	20 Cu. In.
PBR-FPB	Brass flip cover for PBR-1	Diameter: 5 1/16"		
PBR1-FPDB	Round plastic box kit with PBR-FPDB Dark Bronze flip cover & 15 AMP (TR) receptacle*	5 1/16"	3 1/4"	20 Cu. In.
PBR-FPDB	Dark Bronze flip cover for PBR-1	Diameter: 5 1/16"		
PBR1-SPA	Round plastic box kit with PBR-SPA Aluminum screw cover & 15 AMP (TR) receptacle*	5 1/16"	3 1/4"	20 Cu. In.
PBR-SPA	Aluminum screw cover for PBR-1	Diameter: 5 1/16"		
PBR1-SPB	Round plastic box kit with PBR-SPB Brass screw cover & 15 AMP (TR) receptacle*	5 1/16"	3 1/4"	20 Cu. In.
PBR-SPB	Brass screw cover for PBR-1	Diameter: 5 1/16"		
PBR1-SPDB	Round plastic box kit with PBR-SPDB Dark Bronze screw cover & 15 AMP (TR) receptacle*	5 1/16"	3 1/4"	20 Cu. In.
PBR-SPDB	Dark Bronze screw cover for PBR-1	Diameter: 5 1/16"		

>>>> For Replacement Plugs, see page 49

* Standard duplex receptacle only, cannot accommodate decora/GFI style receptacle

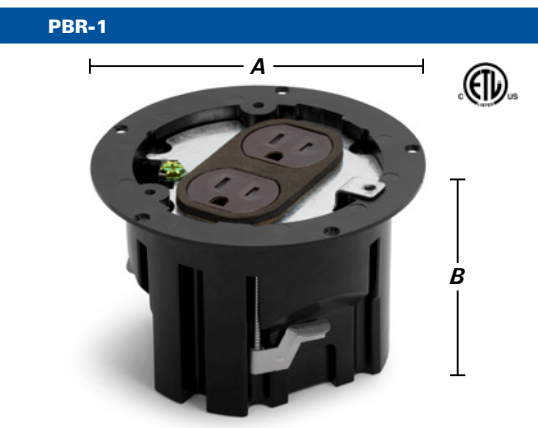

FEATURES & BENEFITS

- **Lightweight** polymer construction
- Options include **choice of metal covers** (aluminum, brass or dark bronze) and **closure style** (flip lid or screw plug)
- **Economical savings** over cast iron & stamped metal floor box assemblies
- **Ease of installation**
- **Adjustable wing clamps** for added installation support

Finished floor installation

ETL LISTED US
Intertek
4004534

- Conforms to UL514C
- ETL listing #4004534

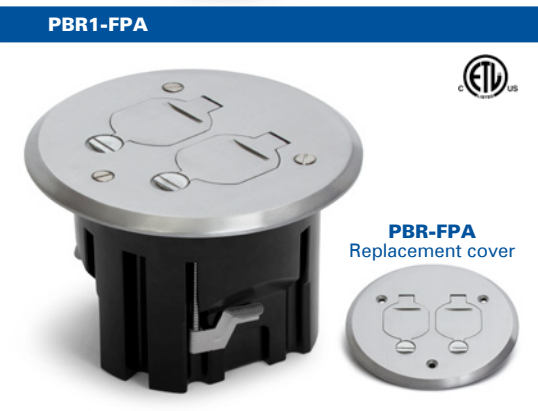
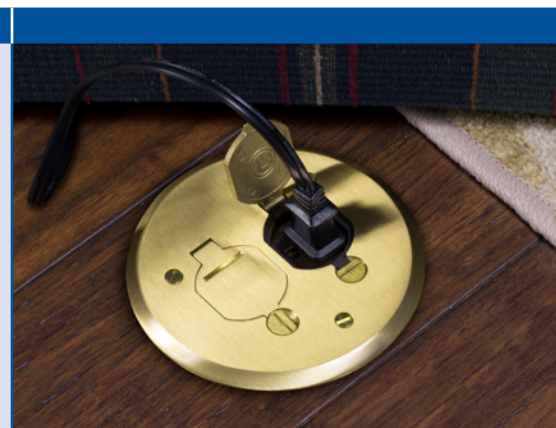

Plastic Boxes and Covers (Finished floor installation)

CATALOG #	DESCRIPTION	DIMENSIONS			INTERIOR CAPACITY
		L	W	H	
1101-PB	Single gang plastic box with 15 AMP (TR) duplex receptacle* included	4 3/4"	3 1/8"	3 3/8"	22.5 Cu. In.
PB1-FPA	Single gang plastic box kit with RRP-2-FPA Aluminum flip cover & 15 AMP (TR) receptacle*	5 1/8"	3 1/2"	3 5/8"	22.5 Cu. In.
RRP-2-FPA	Aluminum flip cover for 1101-PB	5 1/8"	3 1/2"		
PB1-FPB	Single gang plastic box kit with RRP-2-FPB Brass flip cover & 15 AMP (TR) receptacle*	5 1/8"	3 1/2"	3 5/8"	22.5 Cu. In.
RRP-2-FPB	Brass flip cover for 1101-PB	5 1/8"	3 1/2"		
PB1-SPA	Single gang plastic box kit with RRP-2-SPA Aluminum screw cover & 15 AMP (TR) receptacle*	5 1/8"	3 1/2"	3 5/8"	22.5 Cu. In.
RRP-2-SPA	Aluminum screw cover for 1101-PB	5 1/8"	3 1/2"		
PB1-SPB	Single gang plastic box kit with RRP-2-SPB Brass screw cover & 15 AMP (TR) receptacle*	5 1/8"	3 1/2"	3 5/8"	22.5 Cu. In.
RRP-2-SPB	Brass screw cover for 1101-PB	5 1/8"	3 1/2"		

>>>> For Replacement Plugs, see page 49

* Standard duplex receptacle only, cannot accommodate decora/GFI style receptacle

1101-PB



FEATURES & BENEFITS

- **Lightweight** polymer construction
- Options include **choice of metal covers** (aluminum or brass) and **closure style** (flip lid or screw plug)
- **Economical savings** over cast iron & stamped metal floor box assemblies
- **Ease of installation**
- **Adjustable wing clamps** for added installation support



- **Conforms to UL514C**
- **ETL listing #4004534**

Finished floor installation



PB1-FPA



RRP-2-FPA
Replacement cover



PB1-FPB



RRP-2-FPB
Replacement cover



PB1-SPA



RRP-2-SPA
Replacement cover



PB1-SPB



RRP-2-SPB
Replacement cover



Plastic Boxes and Covers (Finished floor installation)

CATALOG #	DESCRIPTION	DIMENSIONS			INTERIOR CAPACITY
		L	W	H	
1102-PB	Two gang plastic box with (2) 15 AMP (TR) duplex receptacles* included	4 3/4"	4 3/4"	3 5/8"	45 Cu. In.
PB2-FPA ①	Two gang plastic box kit with RRP-4-FPA Aluminum flip cover & 2 15 AMP (TR) receptacles*	5"	5"	3 5/8"	45 Cu. In.
RRP-4-FPA	Aluminum flip cover for 1102-PB	5"	5"		
PB2-FPB ①	Two gang plastic box kit with RRP-4-FPB Brass flip cover & 2 15 AMP (TR) receptacles*	5"	5"	3 5/8"	45 Cu. In.
RRP-4-FPB	Brass flip cover for 1102-PB	5"	5"		
PB2-SPA ①	Two gang plastic box kit with RRP-4-SPA Aluminum screw cover & 2 15 AMP (TR) receptacles*	5"	5"	3 5/8"	45 Cu. In.
RRP-4-SPA	Aluminum screw cover for 1102-PB	5"	5"		
PB2-SPB ①	Two gang plastic box kit with RRP-4-SPB Brass flip cover & 2 15 AMP (TR) receptacles*	5"	5"	3 5/8"	45 Cu. In.
RRP-4-SPB	Brass screw cover for 1102-PB	5"	5"		

① Also includes one RRP-2-PQ quad port

* Standard duplex receptacle only, cannot accommodate decora/GFI style receptacle

>>>> For Replacement Plugs, see page 49

1102-PB



FEATURES & BENEFITS

- **Lightweight** polymer construction
- Options include **choice of metal covers** (aluminum or brass) and **closure style** (flip lid or screw plug)
- **Economical savings** over cast iron & stamped metal floor box assemblies
- **Ease of installation**
- **Adjustable wing clamps** for added installation support
- **Partitions are removable**



Intertek
4004534

- **Conforms to UL514C**
- **ETL listing #4004534**

Finished floor installation

PB2-FPA (Includes RRP-2-PQ Quad Port, max 2 CAT6 jacks)



PB2-FPB (Includes RRP-2-PQ Quad Port, max 2 CAT6 jacks)



PB2-SPA (Includes RRP-2-PQ Quad Port, max 2 CAT6 jacks)



PB2-SPB (Includes RRP-2-PQ Quad Port, max 2 CAT6 jacks)



Plastic Boxes and Covers (Finished floor installation)

CATALOG #	DESCRIPTION	DIMENSIONS			INTERIOR CAPACITY
		L	W	H	
1103-PB	Three gang plastic box with (3) 15 AMP (TR) duplex receptacles* included	4 3/4"	6 5/8"	3 3/8"	64 Cu. In.
PB3-FPA ①	Three gang plastic box kit with RRP-6-FPA Aluminum flip cover & 3 15 AMP (TR) receptacles*	5 1/8"	6 15/16"	3 5/8"	64 Cu. In.
RRP-6-FPA	Aluminum flip cover for 1103-PB	5 1/8"	6 15/16"		
PB3-FPB ①	Three gang plastic box kit with RRP-6-FPB Brass flip cover & 3 15 AMP (TR) receptacles*	5 1/8"	6 15/16"	3 5/8"	64 Cu. In.
RRP-6-FPB	Brass flip cover for 1103-PB	5 1/8"	6 15/16"		
PB3-SPA ①	Three gang plastic box kit with RRP-6-SPA Aluminum screw cover & 3 15 AMP (TR) receptacles*	5 1/8"	6 15/16"	3 5/8"	64 Cu. In.
RRP-6-SPA	Aluminum screw cover for 1103-PB	5 1/8"	6 15/16"		
PB3-SPB ①	Three gang plastic box kit with RRP-6-SPB Brass flip cover & 3 15 AMP (TR) receptacles*	5 1/8"	6 15/16"	3 5/8"	64 Cu. In.
RRP-6-SPB	Brass screw cover for 1103-PB	5 1/8"	6 15/16"		

① Also includes one RRP-2-PQ quad port

*Standard duplex receptacle only, cannot accommodate decora/GFI style receptacle

»»»» For Replacement Plugs, see page 49

1103-PB



FEATURES & BENEFITS

- **Lightweight** polymer construction
- Options include **choice of metal covers** (aluminum or brass) and **closure style** (flip lid or screw plug)
- **Economical savings** over cast iron & stamped metal floor box assemblies
- **Ease of installation**
- **Adjustable wing clamps** for added installation support
- **Partitions are removable**



Intertek
4004534

- **Conforms to UL514C**
- **ETL listing #4004534**

Finished floor installation

PB3-FPA (Includes RRP-2-PQ Quad Port, max 2 CAT6 jacks)

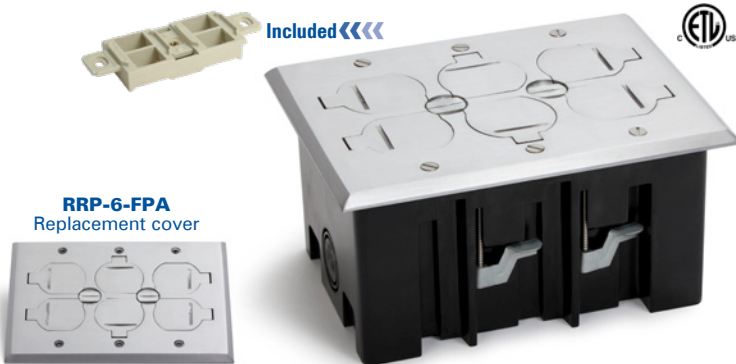

PB3-FPB (Includes RRP-2-PQ Quad Port, max 2 CAT6 jacks)

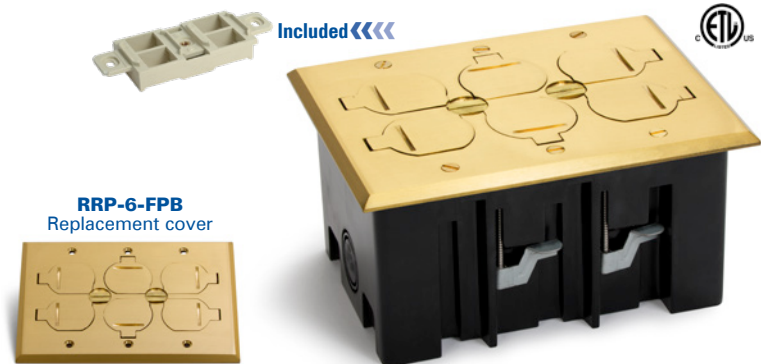

PB3-SPA (Includes RRP-2-PQ Quad Port, max 2 CAT6 jacks)



PB3-SPB (Includes RRP-2-PQ Quad Port, max 2 CAT6 jacks)



Residential Floor Boxes

LEW ELECTRIC FITTINGS COMPANY
For more information, call 877-537-2019
www.lewelectric.com

26 >>>>> PUPF Series | RCFB Series | Plastic Box Series | RRP Series | SWB Series | 812 Series



SWB Boxes and Covers (Subfloor installation)

>>>> For Replacement Plugs, see page 49

SWB-1-BP

SWB-1-BP: Plated recessed floor plate assembly (single receptacle with box); includes 15 AMP (TR) receptacle.

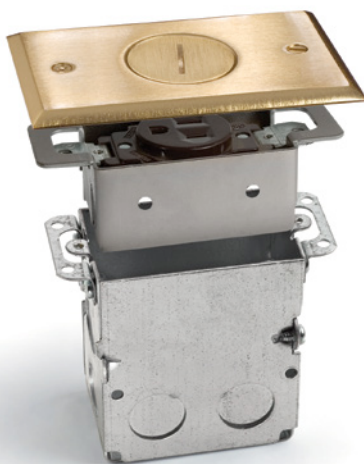

Width	2 13/16"	Finish Options
Length	4 5/8"	Brass Plated » SWB-1-BP
Height	4"	◀ NEW Summer 2022 Dark Bronze Plated » SWB-1-DBP
Interior Capacity	18 Cu. In.	Nickel Plated » SWB-1-NP

Replacement Cover
Brass Plated » RRP-1-BPR
Dark Bronze Plated » RRP-1-DBR
Nickel Plated » RRP-1-NPR

SWB-2

SWB-2: Recessed floor plate assembly (duplex receptacle with box); includes 15 AMP (TR) receptacle (Standard duplex receptacle only, cannot accommodate decora/GFI style receptacle)

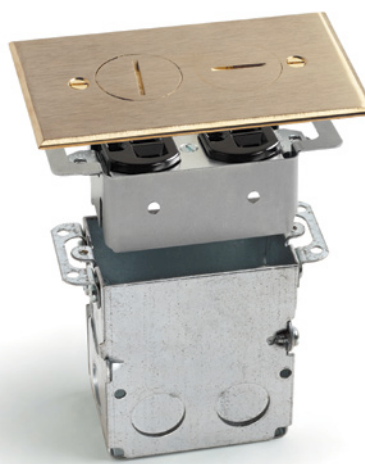

Width	2 7/8"	Finish Options
Length	5"	Brass » SWB-2
Height	4"	Aluminum » SWB-2-A
Interior Capacity	18 Cu. In.	◀ NEW Summer 2022 Dark Bronze » SWB-2-DB
		Nickel Silver » SWB-2-NS

Replacement Cover
Brass » RRP-2-BR
Aluminum » RRP-2-AR
Dark Bronze » RRP-2-DBR
Nickel Silver » RRP-2-NSR

SWB-2-T

SWB-2-T: Recessed floor plate assembly (Comm./Data with box); RRP-2-PQ quad port included

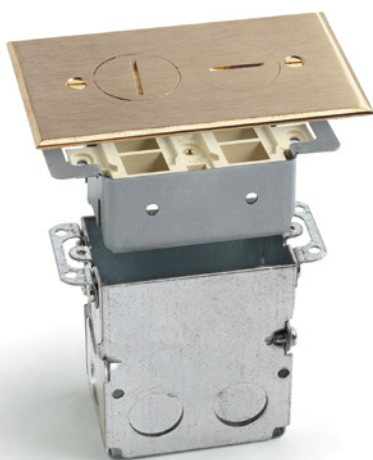

Width	2 7/8"	Finish Options
Length	5"	Brass » SWB-2-T
Height	4"	Aluminum » SWB-2-A-T
Interior Capacity	18 Cu. In.	◀ NEW Summer 2022 Dark Bronze » SWB-2-DB-T
		Nickel Silver » SWB-2-NS-T

Replacement Cover
Brass » RRP-2-BR
Aluminum » RRP-2-AR
Dark Bronze » RRP-2-DBR
Nickel Silver » RRP-2-NSR

SWB-2-LR

SWB-2-LR: Recessed floor plate flip lid assembly (duplex receptacle with box); includes 15 AMP (TR) receptacle (Standard duplex receptacle only, cannot accommodate decora/GFI style receptacle)



Width	2 7/8"	Finish Options
Length	5"	Brass » SWB-2-LR
Height	4"	Aluminum » SWB-2-LR-A
Interior Capacity	18 Cu. In.	◀ NEW Summer 2022 Dark Bronze » SWB-2-LR-DB

Replacement Cover
Brass » RRP-2-LRR
Aluminum » RRP-2-LR-AR
Dark Bronze » RRP-2-LR-DBR

SWB-2-LR-T

SWB-2-LR-T: Recessed floor plate flip lid assembly (Comm./Data with box); RRP-2-PQ quad port included



Width	2 7/8"	Finish Options
Length	5"	Brass » SWB-2-LR-T
Height	4"	Aluminum » SWB-2-LR-A-T
Interior Capacity	18 Cu. In.	◀ NEW Summer 2022 Dark Bronze » SWB-2-LR-DB-T

Replacement Cover
Brass » RRP-2-LRR
Aluminum » RRP-2-LR-AR
Dark Bronze » RRP-2-LR-DBR

SWB: UL & NEMA RECOGNITION

- Box UL #E345966
- Meets NEMA WD1-1983 heavy duty requirement for display receptacle
- All receptacles tamper resistant; UL listing #E309821 (duplex); E237396 (single)

SWB: FEATURES & BENEFITS

- Water tight assembly
- 1/2" Conduit knockouts
- Adjustable up to 3/4" to accommodate any floor

Subfloor installation

SWB Boxes and Covers (Subfloor installation)

>>>> For Replacement Plugs, see page 49

SWB-4: Two gang, divided, recessed floor plate assembly with screw plug cover. Includes 2 15 AMP (TR) receptacles. *One RRP-2-PQ quad port also included.* (Standard duplex receptacle only, cannot accommodate decora/GFI style receptacle)

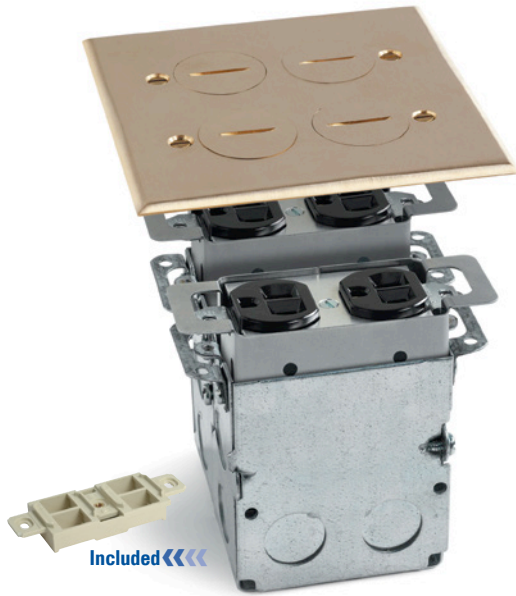

Width
5"
Length
5"
Height
4"

Finish Options

Brass » SWB-4

Aluminum » SWB-4-A

◀ NEW Summer 2022
 Dark Bronze » SWB-4-DB

Replacement Cover

Brass » RRP-4-BP

Aluminum » RRP-4-AP

Dark Bronze » RRP-4-DBP

SWB-4-LR: Two gang, divided, recessed floor plate assembly with flip lid cover. Includes 2 15 AMP (TR) receptacles. *One RRP-2-PQ quad port also included.* (Standard duplex receptacle only, cannot accommodate decora/GFI style receptacle)

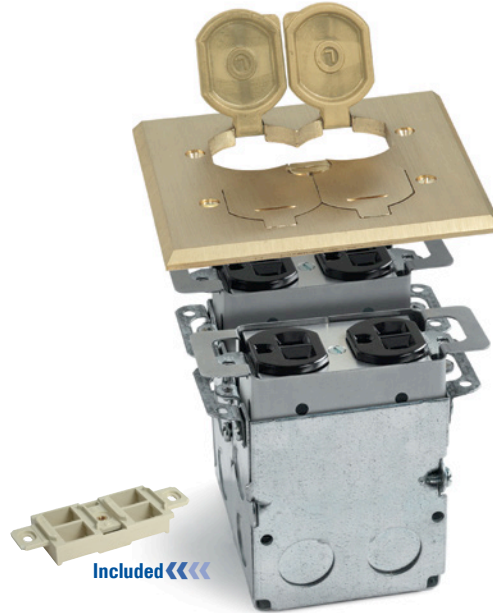

Width
5"
Length
5"
Height
4"

Finish Options

Brass » SWB-4-LR

Aluminum » SWB-4-LR-A

◀ NEW Summer 2022
 Aluminum » SWB-4-LR-DB

Replacement Cover

Brass » RRP-4-BP-LR

Aluminum » RRP-4-AP-LR

Dark Bronze » RRP-4-DBP-LR

SWB-6: Three gang, divided, recessed floor plate assembly with screw plug cover. Includes 3 15 AMP (TR) receptacles. *One RRP-2-PQ quad port also included.* (Standard duplex receptacle only, cannot accommodate decora/GFI style receptacle)



Width
5"
Length
6 7/8"
Height
4"

Finish Options

Brass » SWB-6

Aluminum » SWB-6-A

Replacement Cover

Brass » RRP-6-BP

Aluminum » RRP-6-AP

SWB-6-LR: Three gang, divided, recessed floor plate assembly with flip lid cover. Includes 3 15 AMP (TR) receptacles. *One RRP-2-PQ quad port also included.* (Standard duplex receptacle only, cannot accommodate decora/GFI style receptacle)



Width
5"
Length
6 7/8"
Height
4"

Finish Options

Brass » SWB-6-LR

Aluminum » SWB-6-LR-A

Replacement Cover

Brass » RRP-6-BP-LR

Aluminum » RRP-6-AP-LR

SWB-4 & SWB-6: UL & NEMA RECOGNITION

- Box UL #E345966
- Meets NEMA WD1-1983 heavy duty requirement for display receptacle
- All receptacles tamper resistant; UL listing #E309821 (duplex); E237396 (single)

SWB-4 & SWB-6: FEATURES & BENEFITS

- **Water tight** assembly
- 1/2" Conduit **knockouts**
- **Adjustable** up to 3/4" to accommodate any floor
- **Partitions are removable**

Subfloor installation

812 Boxes (Concrete or wood floor)

>>>> 812 Series UL listing #514A,
#498 and CUL recognized 22.2 #18.1-04
>>>> UL listed receptacle #E309821
>>>> For Replacement Plugs, see page 49

812

812: Cast iron round floor box with duplex receptacle (Does not include cover)
(Standard duplex receptacle only, cannot accommodate decora/GFI style receptacle)

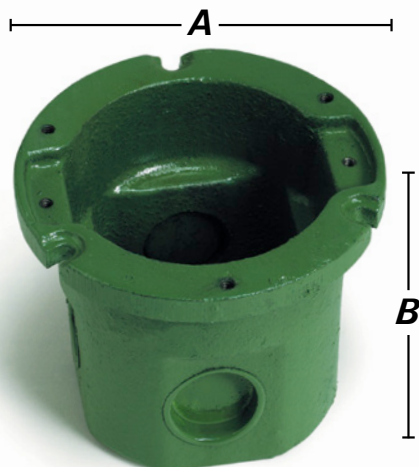



Width (A)	4"
Height (B)	3"
Conduit Openings	Sides (2)- $\frac{3}{4}$ " & (2)- $\frac{1}{2}$ " Bottom (2)- $\frac{1}{2}$ "
Interior Capacity	14.5 Cu. In.

812-DFB

812-DFB: Floor box furnished with 523-DP Cover & 15 AMP (TR) duplex receptacle
(Standard duplex receptacle only, cannot accommodate decora/GFI style receptacle)

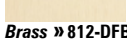

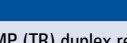
Width (A)	4"
Height (B)	3 $\frac{1}{8}$ "
Conduit Openings	Sides (2)- $\frac{3}{4}$ " & (2)- $\frac{1}{2}$ " Bottom (2)- $\frac{1}{2}$ "
Interior Capacity	14.5 Cu. In.
Finish Options	 Brass » 812-DFB  Aluminum » 812-DFB-A  Dark Bronze » 812-DFB-DB  Nickel Silver » 812-DFB-NS

812-DFB-W/524

812-DFB-W/524: Floor box furnished with 524 Brass Cover and tel. jack



Width (A)	4"
Height (B)	3 $\frac{1}{8}$ "
Conduit Openings	Sides (2)- $\frac{3}{4}$ " & (2)- $\frac{1}{2}$ " Bottom (2)- $\frac{1}{2}$ "
Interior Capacity	14.5 Cu. In.

Includes: 40201-001 – Ivory telephone jack for 812 series





Finish Options	 Brass » 812-DFB-W/524
-----------------------	--

812-DFB-LR

812-DFB-LR: Floor box furnished with DFB-LR Cover & 15 AMP (TR) duplex receptacle
(Standard duplex receptacle only, cannot accommodate decora/GFI style receptacle)

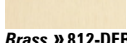



Width (A)	4"
Height (B)	3 $\frac{5}{8}$ "
Conduit Openings	Sides (2)- $\frac{3}{4}$ " & (2)- $\frac{1}{2}$ " Bottom (2)- $\frac{1}{2}$ "
Interior Capacity	14.5 Cu. In.
Finish Options	 Brass » 812-DFB-LR  Aluminum » 812-DFB-LR-A  Dark Bronze » 812-DFB-LR-DB

812-DFB-W/DFB-1

812-DFB-W/DFB-1: Floor box furnished with DFB-1 Cover & 15 AMP (TR) duplex receptacle
(Standard duplex receptacle only, cannot accommodate decora/GFI style receptacle)



Width (A)	4"
Height (B)	3 $\frac{5}{8}$ "
Conduit Openings	Sides (2)- $\frac{3}{4}$ " & (2)- $\frac{1}{2}$ " Bottom (2)- $\frac{1}{2}$ "
Interior Capacity	14.5 Cu. In.
Finish Options	 Brass » 812-DFB-W/DFB-1  Aluminum » 812-DFB-W/DFB-1-A  Dark Bronze » 812-DFB-W/DFB-1-DB

812 Covers and Flanges

1 Standard duplex receptacle only, cannot accommodate decora/GFI style receptacle
 >>>> Marked cULus are UL listed 498
 >>>> For Replacement Plugs, see page 49

523-DP

523-DP: 4" cover (1/8" thick) with (2) 1 1/2" screw plugs for duplex 1



Finish Options

 cULus	 cULus
Brass » 523-DP	Aluminum » 523-DP-A
	 cULus
Dark Bronze » 523-DP-DB	Nickel Silver » 523-DP-NS

524

524: 4" cover (1/8" thick) with 2"–1/2" combo plug for Comm./Data



Finish Options

 cULus
Brass » 524

DFB-LR

DFB-LR: 4" dual hinged cover (1/4" thick) for duplex 1

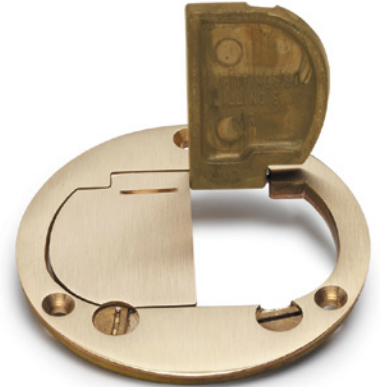

Finish Options

 cULus	 cULus	 NEW Summer 2022
Brass » DFB-LR	Aluminum » DFB-LR-A	Dark Bronze » DFB-LR-DB

DFB-1

DFB-1: 4" hinged cover (1/4" thick) for duplex 1



Finish Options





 cULus		
Brass » DFB-1	Aluminum » DFB-1-A	Dark Bronze » DFB-1-DB

SCF-1

SCF-1: 5 1/4" flange

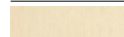

Finish Options

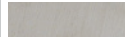

 cULus		 NEW Summer 2022
Brass » SCF-1	Aluminum » SCF-1-A	Dark Bronze » SCF-1-DB
		
Clear Plastic » SCF-1-CP	Nickel Silver » SCF-1-NS	

TCP-1

TCP-1: 5 3/4" flanged cover, with 2"–1/2" combo plug for Comm./Data. or single receptacle



Finish Options





 cULus	
Brass » TCP-1	Nickel Silver » TCP-1-NS
Brass » TCP-1-3/4"	
Brass » TCP-1-1"	

TCP-2

TCP-2: 5 3/4" flanged cover, with (2) 1 1/2" screw plugs for duplex power or Comm./Data 1



Finish Options

 cULus	 cULus
Brass » TCP-2	Aluminum » TCP-2-A
	
Dark Bronze » TCP-2-DB	Nickel Silver » TCP-2-NS

TCP-2-LR

TCP-2-LR: 5 3/4" Seamless flanged cover, with dual flip lid and duplex mounting plate 1



Finish Options

 cULus	 cULus
Brass » TCP-2-LR	Aluminum » TCP-2-LR-A
	
Dark Bronze » TCP-2-LR-DB	

TCP-GR1

TCP-GR1: Brass goof ring for the 812 series; O.D. 7 1/2", I.D. 4"

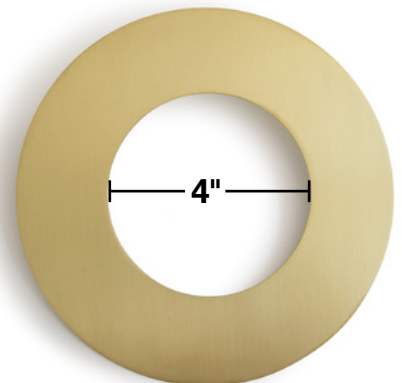

OUTDOOR Floor Box

CATALOG #	DESCRIPTION
OB-1-SP	Outdoor floor box with Stainless Steel cover; Push Button Open ; Includes 20 AMP WR/TR GFI receptacle; Fully IP66 rated water proof (<i>when in closed position</i>). Includes wrench for inside wire connections.
OB-1-SH	Outdoor floor box with Stainless Steel cover; Hex Key Open ; Includes 20 AMP WR/TR GFI receptacle; Fully IP66 rated water proof (<i>when in closed position</i>). Includes wrench for inside wire connections.
OB-1-SP-6PORT ①	Outdoor floor box for Comm./Data with Stainless Steel cover: Push Button Open ; Fully IP66 rated water proof (<i>when in closed position</i>). Includes wrench for inside wire connections.
OB-1-SH-6PORT ①	Outdoor floor box for Comm./Data with Stainless Steel cover: Hex Key Open ; Fully IP66 rated water proof (<i>when in closed position</i>). Includes wrench for inside wire connections.

>>>> ① Max 3 CAT6 jacks per six port

OB-1-SP

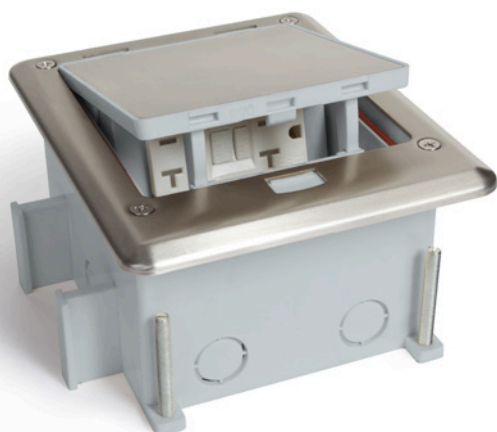

OB-1-SH

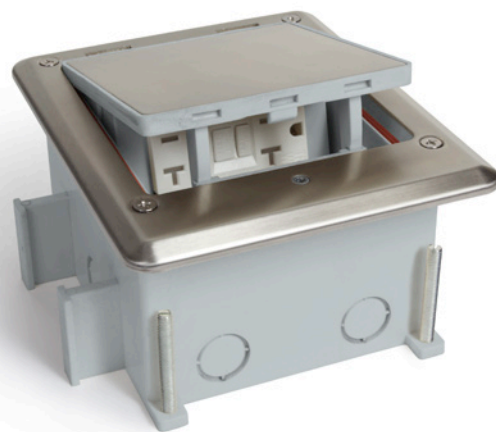

OB-1-SP-6PORT

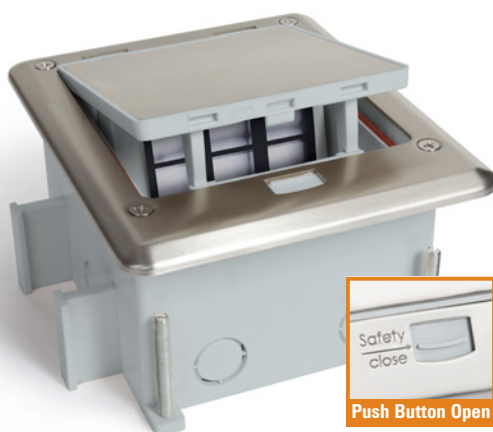

OB-1-SH-6PORT

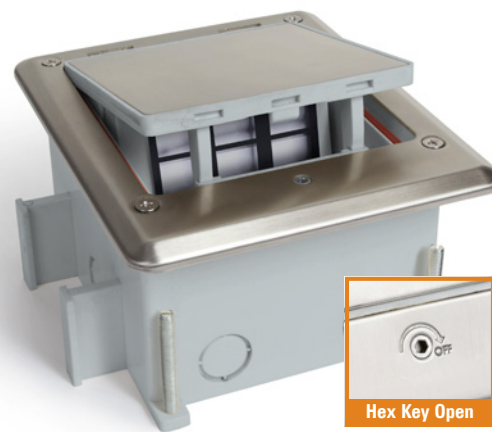

BOX SPECIFICATIONS

- Cover is 6 7/8" L x 5 1/16" W
- Overall height with box and extension ring is 6 1/2"
- Minimum depth can be adjusted upwards of 1 3/4"
- Box dimensions are 5 1/4" L x 4 3/4" W (the cover hangs over more on one side of the box than the other)
- Cover screws are M-4 metric size



FEATURES & BENEFITS

- **Intertek IP66 RATED** BOX (when in closed position)
- **Receptacle:** GFI – UL Listed E473428
- **Tamper Proof opening** (with hex key option)
- **Gangable**
- Includes **weather resistant** U.L. listed receptacle
- **Patent protected**
- **Stainless Steel #316:** increases general corrosion resistance, improves resistance to pitting from chloride ion solutions, and provides increased strength at elevated temperatures.

OUTDOOR *Countertop Box*

CATALOG #	DESCRIPTION
OB-2-CT-SP	Countertop box for covered outdoor kitchens, with Stainless Steel cover; Push Button Open ; Includes 20 AMP WR/TR GFI receptacle; Fully IP66 rated water proof (<i>when in closed position</i>). Includes nine foot 20 amp power cord.

OB-2-CT-SP

FEATURES & BENEFITS



CONFORMS TO UL STD.962A AND 943
 CERTIFIED TO CSA STD.C22.2#308 AND 144.1

- **Intertek IP66 RATED** BOX (when in closed position)
- **Receptacle:** GFI – UL Listed E473428
- Includes **weather resistant/tamper proof** U.L. listed receptacle
- **Stainless Steel #316:** increases general corrosion resistance, improves resistance to pitting from chloride ion solutions, and provides increased strength at elevated temperatures.
- Includes **nine foot 20 amp power cord**

BOX SPECIFICATIONS

- **Cover Dimensions:** 6.8125" L x 5.625" W



PVC Box & Accessories

CATALOG #	DESCRIPTION	DIMENSIONS		INTERIOR CAPACITY
		A	B	
FB	Round PVC box with (2) 3/4" hubs, (2) 1" hubs, (2) 3/4" reducers, (4) 1/2" reducers, ADAPTER RING NOT INCLUDED.	5"	6"	90 Cu. In. (15.5/In.)
FBKIT	Round PVC box with (2) 3/4" hubs, (2) 1" hubs, (2) 3/4" reducers, (4) 1/2" reducers, ADAPTER RING INCLUDED.	5"	6"	90 Cu. In. (15.5/In.)
CATALOG #	DESCRIPTION			
FB-DIV	Divider for FB & FBKIT floor boxes			
LRA-U	Leveling ring for FB & FBKIT			
PUFP-LRA	Leveling ring for PUFP plates			

>>>> UL listing #514C

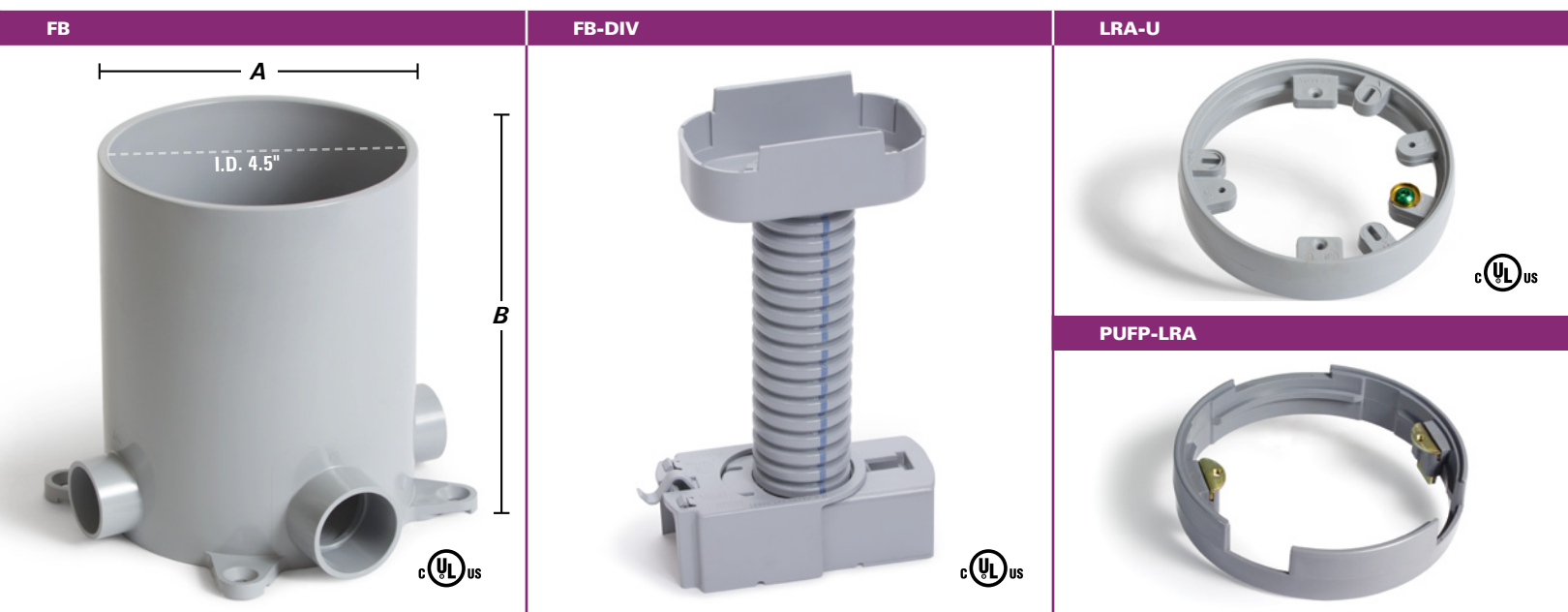

Non-Metallic Covers

CATALOG #	DESCRIPTION
PFC-B	5 3/4" Brown plastic flanged cover with single flip lid. Includes mounting plates and gaskets for duplex receptacle, GFI/decora receptacle and single receptacle/Data.
PFC-E	5 3/4" Ebony plastic flanged cover with single flip lid. Includes mounting plates and gaskets for duplex receptacle, GFI/decora receptacle and single receptacle/Data.
PFC-G	5 3/4" Gold plastic flanged cover with single flip lid. Includes mounting plates and gaskets for duplex receptacle, GFI/decora receptacle and single receptacle/Data.
PFC-S	5 3/4" Gray plastic flanged cover with single flip lid. Includes mounting plates and gaskets for duplex receptacle, GFI/decora receptacle and single receptacle/Data.
PFC-T	5 3/4" Tan plastic flanged cover with single flip lid. Includes mounting plates and gaskets for duplex receptacle, GFI/decora receptacle and single receptacle/Data.

>>>> All covers listed above: UL listing #514C

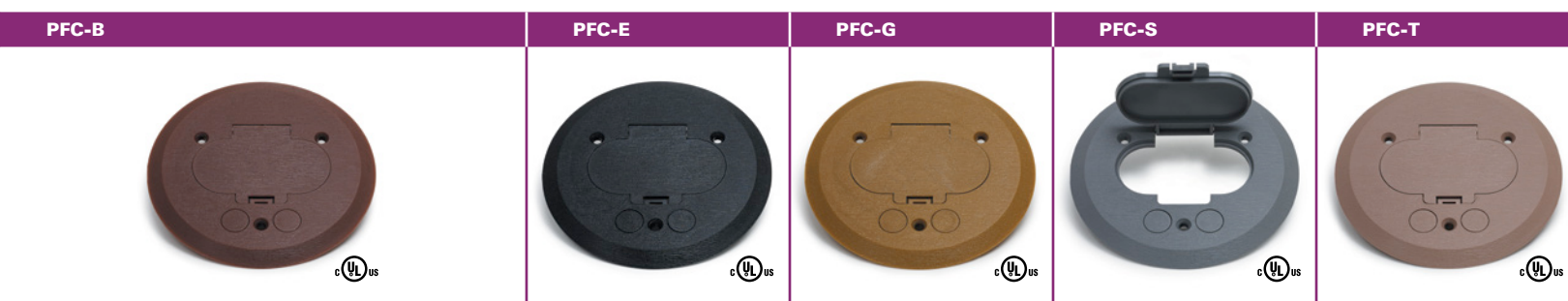

PVC Metal Covers

»»»» For Replacement Plugs, see page 49

CATALOG #	DESCRIPTION
PUFP-B ①	6" Brass pop up floor plate with with 15 AMP (TR) GFI receptacle
PUFP-BC ①	6" Brass pop up floor plate with 6 port Comm./Data device (max 3 CAT6 jacks)
PUFP-BD ①	6" Brass pop up floor plate with 15 AMP (TR) decora receptacle
PUFP-S ①	6" Stainless Steel pop up floor plate with with 15 AMP (TR) GFI receptacle
PUFP-SC ①	6" Stainless Steel pop up floor plate with 6 port Comm./Data device (max 3 CAT6 jacks)
PUFP-SD ①	6" Stainless Steel pop up floor plate with 15 AMP (TR) decora receptacle

»»»» ① Requires PUFP-LRA to mount to FB box

»»»» UL recognized components: PUFP series UL recognized 498, ETL listed P63; TCP series marked cULus are UL listed 498

PUFP-B	PUFP-BC	PUFP-BD
		
PUFP-S	PUFP-SC	PUFP-SD
		

TCP-1: 5 3/4" flanged cover, with 2" - 1/2" combo plug for Comm./Data. or single receptacle
OPTIONS: -3/4" for 2" - 3/4" combo plug for Comm./Data. or single receptacle
 -1" for 2" - 1" combo plug for Comm./Data. or single receptacle

Finish Options

- Brass » TCP-1 cULus
- Brass » TCP-1-3/4"
- Brass » TCP-1-1"
- Nickel Silver » TCP-1-NS



TCP-1-PC: 5 3/4" Brass flanged cover, with 2" - 1/2" combo plug for Comm./Data. or single recept., & (2) 1/2" plugs for Comm./Data

Finish Options

- Brass » TCP-1-PC cULus



TCP-2-PC: 5 3/4" flanged cover, with (2) 1 1/2" screw plugs for duplex power or Comm./Data., & (2) 1/2" plugs for Comm./Data

Finish Options

- Brass » TCP-2-PC cULus
- Aluminum » TCP-2-PC-A



TCP-2: 5 3/4" flanged cover, with (2) 1 1/2", screw plugs for duplex power or Comm./Data

Finish Options

- Brass » TCP-2 cULus
- Aluminum » TCP-2-A cULus
- Dark Bronze » TCP-2-DB
- Nickel Silver » TCP-2-NS



TCP-2-LR: 5 3/4" Seamless flanged cover, with dual flip lid and duplex mounting plate

Finish Options

- Brass » TCP-2-LR cULus
- Aluminum » TCP-2-LR-A cULus
- Dark Bronze » TCP-2-LR-DB



Commercial Floor Boxes

LEW ELECTRIC FITTINGS COMPANY
For more information, call 877-537-2019
www.lewelectric.com

36 >>>>> Access Boxes | 1101 Rectangular Boxes | 32 Round Boxes | Poke-Through/In-Slab | Nozzles



ACCESS FLOOR BOXES:
A great solution for the 2017 NEC
meeting room requirements

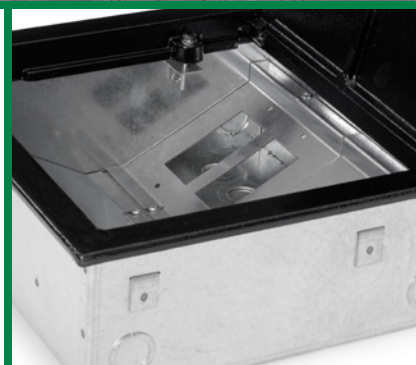
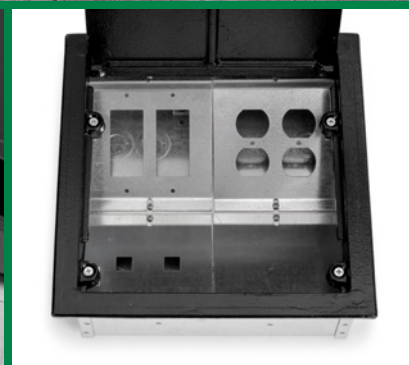

ACCESS Floor boxes

RF9C & RF10C
 CSA #79115

THE CF9C SERIES BOX is a dual service floor box for use with conduit in a **poured concrete floor**. The box is constructed of 16 ga. galvanized steel and comes complete with 1/4" cast aluminum cover assembly. Boxes are shipped with disposable sheet metal cover to protect box during concrete pour. Box supplied with two 1/2-3/4" combination conduit knockouts each end for conduit feed and complete with four adjustable legs for pre-pour adjustment. Standard boxes supplied with power plates and data/communication plates punched to accept specified devices (see below).

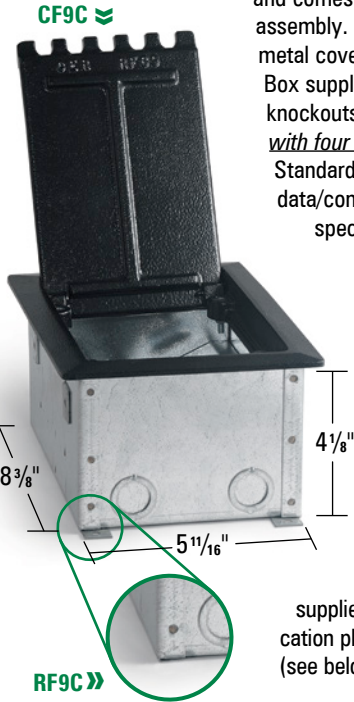

THE RF9C SERIES BOX is a dual service **raised floor box**. The box is constructed of 16 Ga. Galvanized steel and is supplied complete with 1/4" cast aluminum cover assembly. Box supplied with two 1/2-3/4" combination conduit knockouts at each end (does not include 4 adjustable legs). RF9 series access floor boxes are constructed with multiple compartments to suit application. Standard boxes supplied with power plates and data/communication plates punched to accept specified devices (see below).

THE CF10C SERIES BOX is a large capacity dual service floor box for use with conduit in a **poured concrete floor**. The box is constructed of 16 ga. galvanized steel and comes complete with a 1/4" cast aluminum cover assembly. Boxes are shipped with disposable sheet metal cover to protect box during concrete pour. Box supplied with two 1/2-3/4" combination conduit knockouts each end for conduit feed and complete with four adjustable legs for pre-pour adjustment. Standard boxes supplied with power plates and data/communication plates punched to accept specified devices (see below).

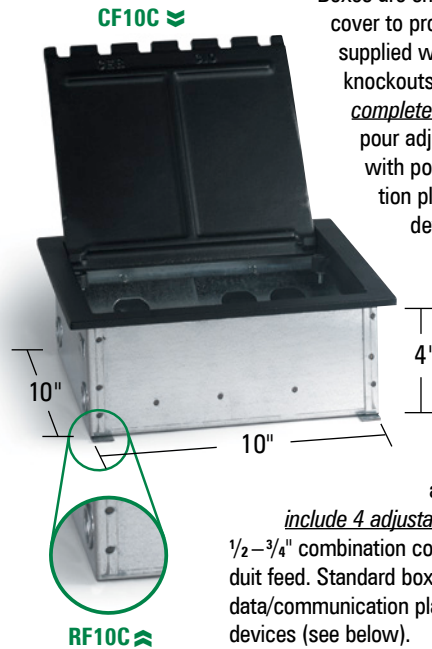

THE RF10C SERIES BOX is a large capacity dual service floor box for use in a **raised floor**. The box is constructed of 16 ga. galvanized steel and comes complete with 1/4" cast aluminum cover assembly (does not include 4 adjustable legs). Box supplied with two 1/2-3/4" combination conduit knockouts each end for conduit feed. Standard boxes supplied with power plates and data/communication plates punched to accept specified devices (see below).

Power Device Plate Specifications

Receptacles are not normally supplied with boxes, contact factory for pricing with details of any receptacles that are required to be supplied with boxes.

- | | |
|---------------------------|-------------------------|
| 1 = 1 std duplex cut out | 3 = 1 "Decora" cut out |
| 2 = 2 std duplex cut outs | 4 = 2 "Decora" cut outs |

Note: Decora cut outs measure 1.3125" x 2.66"

Tel/Data Device Plate Specifications

Receptacles are not normally supplied with boxes, contact factory for pricing with details of any receptacles that are required to be supplied with boxes.

- | | | |
|-------------------------|-----------------------|-----------------------|
| A = 1 "Decora" cut out | C = 1 "RJ45" cut out | E = 3 "RJ45" cut outs |
| B = 2 "Decora" cut outs | D = 2 "RJ45" cut outs | F = 4 "RJ45" cut outs |

Note: Decora cut outs measure 1.3125" x 2.66"; RJ45 cut outs measure .765" x .585"

Power Device Plate Specifications

Receptacles are not normally supplied with boxes, contact factory for pricing with details of any receptacles that are required to be supplied with boxes.

- | | |
|---------------------------|---------------------------|
| 1 = 1 std duplex cut out | 5 = 3 std duplex cut outs |
| 2 = 2 std duplex cut outs | 6 = 4 std duplex cut outs |
| 3 = 1 "Decora" cut out | 7 = 3 "Decora" cut outs |
| 4 = 2 "Decora" cut outs | 8 = 4 "Decora" cut outs |

Note: Decora cut outs measure 1.3125" x 2.66"

Tel/Data Device Plate Specifications

Receptacles are not normally supplied with boxes, contact factory for pricing with details of any receptacles that are required to be supplied with boxes.

- | | | |
|-------------------------|-----------------------|-------------------------|
| A = 1 "Decora" cut out | E = 3 "RJ45" cut outs | J = 7 "RJ45" cut outs |
| B = 2 "Decora" cut outs | F = 4 "RJ45" cut outs | K = 8 "RJ45" cut outs |
| C = 1 "RJ45" cut out | G = 5 "RJ45" cut outs | M = 3 "Decora" cut outs |
| D = 2 "RJ45" cut outs | H = 6 "RJ45" cut outs | P = 4 "Decora" cut outs |

Note: Decora cut outs measure 1.3125" x 2.66"; RJ45 cut outs measure .765" x .585"

Standard Ordering Specifications

- Specify **box type** [CF9C]
- Specify **power device plate** [ex. CF9C2 = 2 std duplex cut outs.]
- Specify **Tel/Data device plates** [ex. CF9C2C = 2 std duplex cut outs for power, 1 RJ45 for Tel/Data.]
- Standard lid color is Black** [ex. CF9C2C-BLK]
Add -ALU for Aluminum lid (special order)

Standard Ordering Specifications

- Specify **box type** [CF10C]
- Specify **power device plate** [e.g. CF10C6 = 4 std duplex cut outs.]
- Specify **Tel/Data device plates** [e.g. CF10C6BD = 4 duplex cut outs for power, 2 Decora & 2 RJ45 for Tel/Data.]
- Standard lid color is Black** [ex. CF10C6BD-BLK]
Add -ALU for Aluminum lid (special order)

1101 Rectangular Boxes—Covers & Flanges

CATALOG #	DESCRIPTION	LENGTH	WIDTH	HEIGHT	VOLUME
1101-SMB	One gang, deep stamped steel floor box	6 1/16"	4 13/16"	3 1/4"	50.3 Cu. In.
1102-SMB	Two gang, deep stamped steel floor box	9 3/16"	4 13/16"	3 13/16"	48.5 Cu. In. per gang
1103-SMB	Three gang, deep stamped steel floor box	12 3/8"	4 13/16"	3 1/4"	38.3 Cu. In. per gang
SH-1101-SMB	One gang, shallow stamped steel floor box	6 1/16"	4 13/16"	2 5/16"	31.5 Cu. In.
SH-1102-SMB	Two gang, shallow stamped steel floor box	9 3/16"	4 13/16"	2 5/16"	33.5 Cu. In. per gang
SH-1103-SMB	Three gang, shallow stamped steel floor box	12 3/8"	4 13/16"	2 11/16"	25.5 Cu. In. per gang
1101-DBE ① ②	One gang, brass frame	4 5/16"	3 11/32"	5/8"	xxxxx
1102-DBE ① ②	Two gang, brass frame	6 3/8"	4 3/8"	5/8"	xxxxx
1103-DBE ① ②	Three gang, brass frame	9 5/16"	4 5/16"	5/8"	xxxxx

① Add -A for Aluminum tile frame; ② Add -B for Brass tile frame

>>>> All boxes UL listing #514A

>>>> Tile frames not included with stamped steel floor box. All tile frames 5/8" overall height

>>>> All boxes pre-pour adjustment of 2 1/4" and after pour adjustment 1/2"

>>>> All boxes include a concrete cap

>>>> Knockouts: *Deep* – Sides and Bottom: 3/4", 1", 1 1/4"; *Shallow* – Sides: 1/2" and 3/4"; Bottom: 3/4", 1" and 1 1/4"

1101-SMB

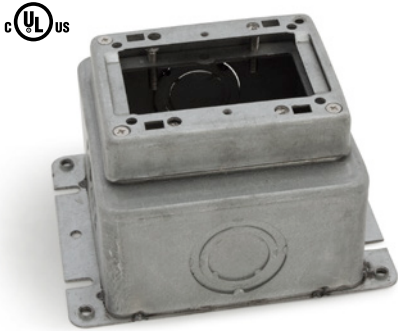

SH-1101-SMB

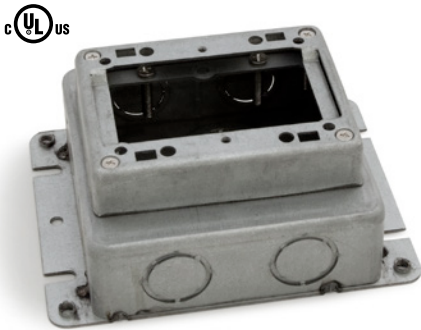

1101-DBE-B

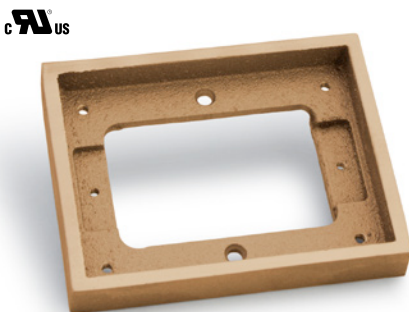

1102-SMB



SH-1102-SMB

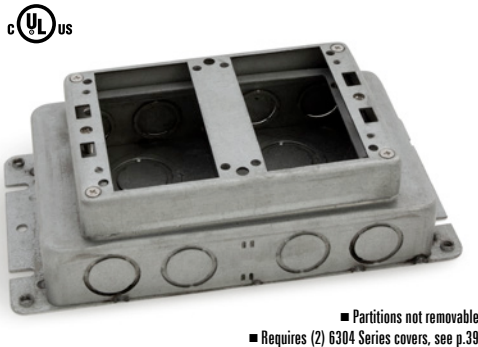

1102-DBE-A

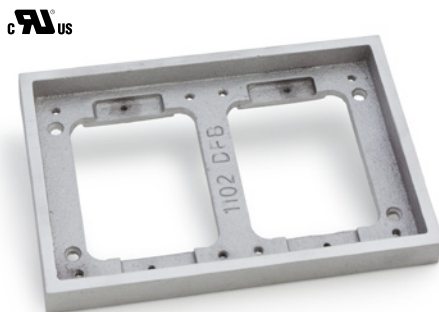

1103-SMB



SH-1103-SMB

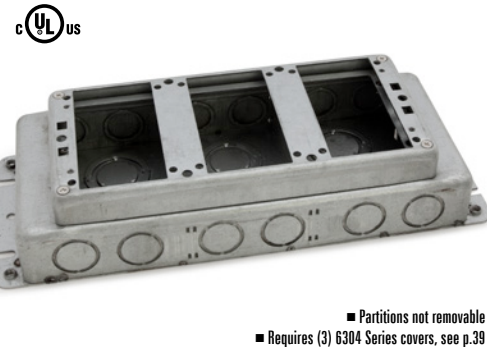

1103-DBE-B

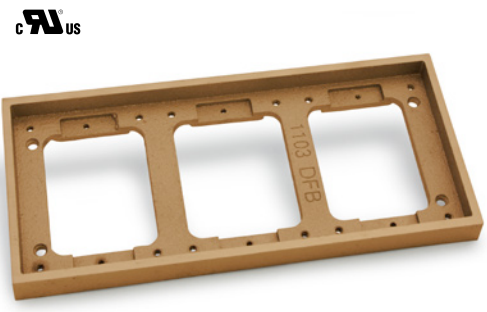

1101 Rectangular Boxes—Covers & Flanges

»»»» For Replacement Plugs, see page 49

6304-DFB-1

6304-DFB-1: Hinged 2 7/8" x 3 7/8" cover (1/4" thick) for duplex

OPTIONS: -TEL for Comm./Data
 -GFI for GFI or decora receptacle



Finish Options

 
 Brass » 6304-DFB-1
 Brass » 6304-DFB-1-TEL
 Brass » 6304-DFB-1-GFI

 
 Aluminum » 6304-DFB-1-A
 Aluminum » 6304-DFB-1-TEL-A
 Aluminum » 6304-DFB-1-GFI-A

6304-DFB-LR

6304-DFB-LR: Dual hinged 2 7/8" x 3 7/8" cover (1/4" thick) for duplex

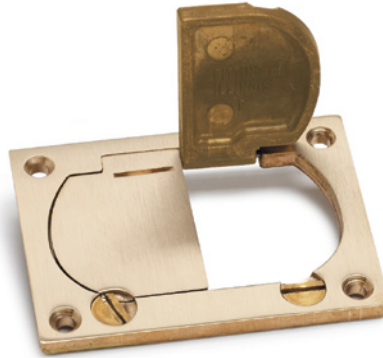

Finish Options

 
 Brass » 6304-DFB-LR

 Aluminum » 6304-DFB-LR-A

6304-DP

6304-DP: 2 7/8" x 3 7/8" cover (1/8" thick) with (2) 1 1/2" screw plugs for duplex



Finish Options

 
 Brass » 6304-DP

 Aluminum » 6304-DP-A

6304-S

6304-S: 2 7/8" x 3 7/8" cover (1/8" thick) with 2"–1/2" combo plug for Comm./Data



Finish Options

 
 Brass » 6304-S

 Aluminum » 6304-S-A

6304-S-3/4

6304-S-3/4: Brass, 2 7/8" x 3 7/8" cover (1/8" thick) with 2"–3/4" combo plug for Comm./Data



Finish Options

 Brass » 6304-S-3/4

6304-S-1

6304-S-1: Brass, 2 7/8" x 3 7/8" cover (1/8" thick) with 2"–1" combo plug for Comm./Data



Finish Options

 Brass » 6304-S-1

CF-1101-DFB

CF-1101-DFB: Single gang carpet flange, 5 1/32" x 6 1/4"



Finish Options

 Brass » CF-1101-DFB

 Aluminum » CF-1101-DFB-A

CF-1102-DFB

CF-1102-DFB: Two gang carpet flange, 6 1/4" x 8 1/4"



Finish Options

 Brass » CF-1102-DFB

 Aluminum » CF-1102-DFB-A

CF-1103-DFB

CF-1103-DFB: Three gang Brass carpet flange, 6 1/4" x 11 1/8"



Finish Options

 Brass » CF-1103-DFB

 Aluminum » CF-1103-DFB-A

1101 Rectangular Boxes—Fully Adjustable

CATALOG #	DESCRIPTION	DIMENSIONS			ADJUST AFTER	INTERIOR CAPACITY	CONDUIT OPENINGS	MAX TAP
		H	L	W				
1101-58 ①	Deep, single gang cast box <i>Fully adjustable</i>	3 3/4"	4 1/4"	3 3/8"	3/8"	13 Cu. In. (Min)	Sides (4) 3/4"	1 1/4"
1102-58 ①	Deep, two gang cast box (partitioned—removable), <i>Fully adjustable</i>	3 3/4"	6 3/8"	4 3/8"	3/8"	26 Cu. In. (Min) (13 Cu. In./Gang)	Sides (6) 3/4"	1 1/4"
1103-58 ①	Deep, three gang cast box (partitioned—removable), <i>Fully adjustable</i>	3 3/4"	9 1/4"	4 5/16"	3/8"	40 Cu. In. (Min) (13 Cu. In./Gang)	Sides (8) 3/4"	1 1/4"

① Add -A for Aluminum finish

>>>> All boxes UL listing #514A, #498

>>>> All boxes include a concrete cap

1101-58

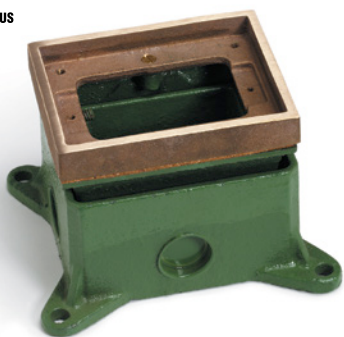

1102-58-A

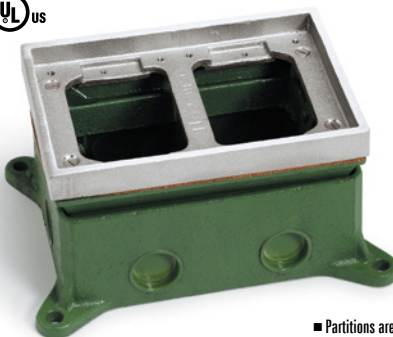

■ Partitions are removable
■ Requires (2) 6304 Series covers, see p.41

1103-58



■ Partitions are removable
■ Requires (3) 6304 Series covers, see p.41

1101 Rectangular Boxes—Semi Adjustable

CATALOG #	DESCRIPTION	DIMENSIONS			ADJUST BEFORE	INTERIOR CAPACITY	CONDUIT OPENINGS	MAX TAP
		H	L	W				
SH-6262-58 ①	Shallow, two gang cast box (partitioned—removable), <i>Semi adjustable</i>	2 1/4"	6 3/8"	4 3/8"	1"	25 Cu. In. (12.5 Cu. In./Gang)	Sides (6) 3/4"	1"
SH-6263-58 ①	Shallow, three gang cast box (partitioned—removable), <i>Semi adjustable</i>	2 1/4"	9 1/4"	4 5/16"	1"	50 Cu. In. (16.5 Cu. In./Gang)	Sides (8) 3/4"	1"

① Add -A for Aluminum finish

>>>> All boxes UL listing #514A, #498

>>>> All boxes include a concrete cap

SH-6262-58-A

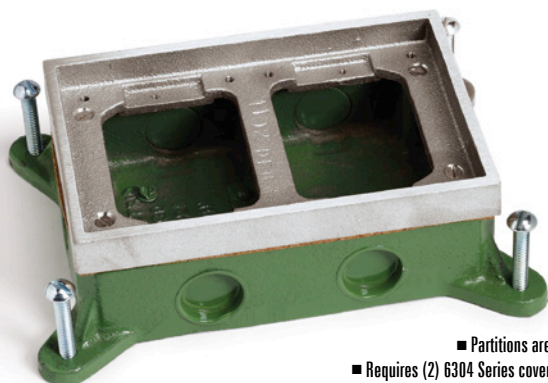

■ Partitions are removable
■ Requires (2) 6304 Series covers, see p.41

SH-6263-58

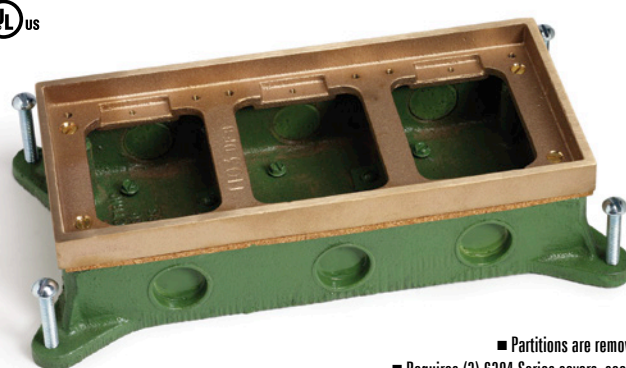

■ Partitions are removable
■ Requires (3) 6304 Series covers, see p.41

1101 Rectangular Boxes—Covers & Flanges

»»»» For Replacement Plugs, see page 49

6304-DFB-1

6304-DFB-1: Hinged 2 7/8" x 3 7/8" cover (1/4" thick) for duplex

OPTIONS: -TEL for Comm./Data
 -GFI for GFI or Decora receptacle



Finish Options

 
 Brass » 6304-DFB-1
 Brass » 6304-DFB-1-TEL
 Brass » 6304-DFB-1-GFI

 
 Aluminum » 6304-DFB-1-A
 Aluminum » 6304-DFB-1-TEL-A
 Aluminum » 6304-DFB-1-GFI-A

6304-DFB-LR

6304-DFB-LR: Dual hinged 2 7/8" x 3 7/8" cover (1/4" thick) for duplex

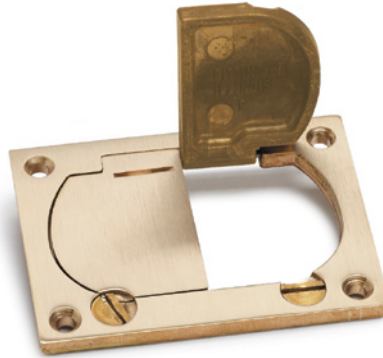

Finish Options

 
 Brass » 6304-DFB-LR

 Aluminum » 6304-DFB-LR-A

6304-DP

6304-DP: 2 7/8" x 3 7/8" cover (1/8" thick) with (2) 1 1/2" screw plugs for duplex



Finish Options

 
 Brass » 6304-DP

 Aluminum » 6304-DP-A

6304-S

6304-S: 2 7/8" x 3 7/8" cover (1/8" thick) with 2"–1/2" combo plug for Comm./Data



Finish Options

 
 Brass » 6304-S

 Aluminum » 6304-S-A

6304-S-3/4

6304-S-3/4: Brass, 2 7/8" x 3 7/8" cover (1/8" thick) with 2"–3/4" combo plug for Comm./Data



Finish Options

 Brass » 6304-S-3/4

6304-S-1

6304-S-1: Brass, 2 7/8" x 3 7/8" cover (1/8" thick) with 2"–1" combo plug for Comm./Data



Finish Options

 Brass » 6304-S-1

CF-1101-DFB

CF-1101-DFB: Single gang carpet flange, 5 1/32" x 6 1/4"

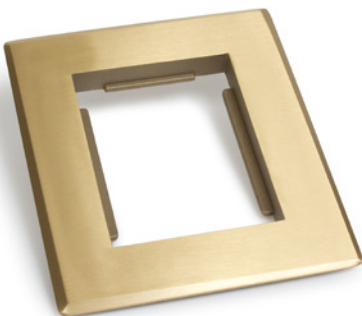

Finish Options

 Brass » CF-1101-DFB

 Aluminum » CF-1101-DFB-A

CF-1102-DFB

CF-1102-DFB: Two gang carpet flange, 6 1/4" x 8 1/4"



Finish Options

 Brass » CF-1102-DFB

 Aluminum » CF-1102-DFB-A

CF-1103-DFB

CF-1103-DFB: Three gang Brass carpet flange, 6 1/4" x 11 1/8"



Finish Options

 Brass » CF-1103-DFB

 Aluminum » CF-1103-DFB-A

32 Round Boxes, Adjustable

CATALOG #	DESCRIPTION	DIMENSIONS		ADJUST BEFORE	ADJUST AFTER	INTERIOR CAPACITY	CONDUIT OPENINGS	MAX TAP
		A	B					
532-SB-58 ①	Shallow, cast box, fully adjustable	4 1/4"	3 5/16"	X	3/8"	14.1 Cu. In.	Sides (4) 3/4"	1 1/4"
532-SMB	Deep Stamped Steel, fully adjustable	4 11/16"	3 3/4"	2 1/4"	1/2"	57 Cu. In.	1/2", 3/4", 1", 1 1/4"	none
532-SMB-SB ③	Shallow, Stamped Steel, fully adjustable	4 11/16"	2 13/16"	2 1/4"	1/2"	43.8 Cu. In.	Sides (6) 1/2", (4) 3/4" Bottom (3) 1/2", (2) 3/4"	none
CATALOG #	DESCRIPTION	DIMENSIONS		ADJUST BEFORE	ADJUST AFTER	INTERIOR CAPACITY	CONDUIT OPENINGS	MAX TAP
		A	B					
332-58 ①	Shallow, cast box, semi adjustable	4 1/4"	2 1/8"	1"	X	12 Cu. In.	Sides (4) 3/4"	1"
MW-332-58 ①	Core drill cast box, semi adjustable	4 1/4"	2 1/8"	1/2"	X	12 Cu. In.	Sides (4) 3/4" ②	1"

① Add -A for Aluminum finish; ② additional 3/4" conduit opening in bottom of box;

③ additional 3/4" (2) & 1/2" (2) conduit openings in bottom

>>>> All boxes UL listing #514A, #498

>>>> All boxes: Single service only (power or data)

532-SB-58



532-SMB

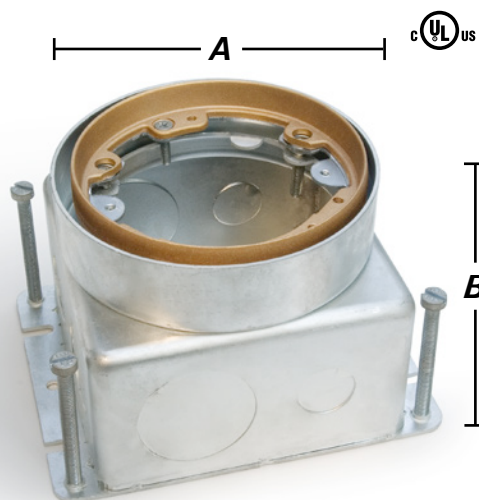

532-SMB-SB

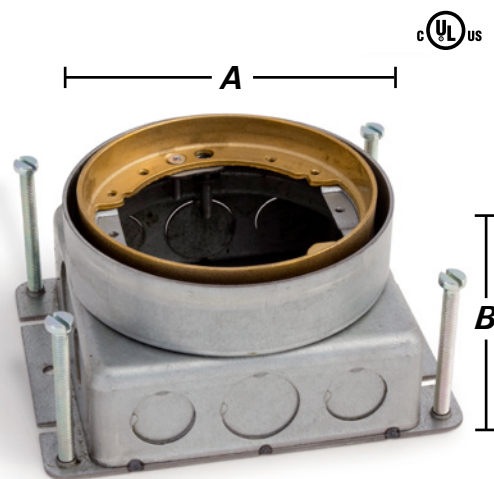

332-58

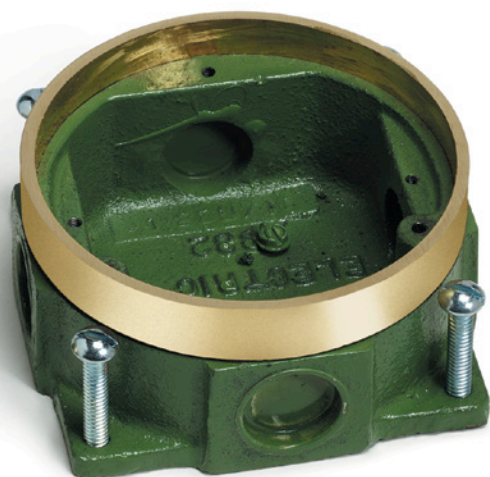

MW-332-58



32 Round Box Covers

>>>> Marked cULus are UL listed 498
 >>>> For Replacement Plugs, see page 49

523-DP

523-DP: 4" cover (1/8" thick) with (2) 1 1/2" screw plugs for duplex



Finish Options

 cULus Brass » 523-DP	 cULus Aluminum » 523-DP-A
 cULus Dark Bronze » 523-DP-DB	 cULus Nickel Silver » 523-DP-NS

524

524: 4" cover (1/8" thick) with 2" - 1/2" combo plug for Comm./Data



Finish Options

 cULus Brass » 524
--

DFB-LR

DFB-LR: 4" dual hinged cover (1/4" thick) for duplex

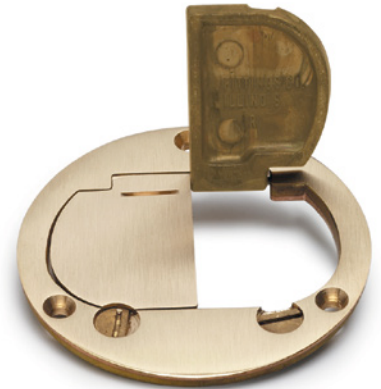

Finish Options

 cULus Brass » DFB-LR	 cULus Aluminum » DFB-LR-A	 cULus Dark Bronze » DFB-LR-DB
---	--	--

DFB-1

DFB-1: 4" hinged cover (1/4" thick) for duplex



Finish Options





 cULus Brass » DFB-1	 cULus Aluminum » DFB-1-A	 cULus Dark Bronze » DFB-1-DB
---	---	---

SCF-1

SCF-1: 5 1/4" flange

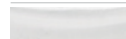

Finish Options

 cULus Brass » SCF-1	 cULus Aluminum » SCF-1-A	 cULus Dark Bronze » SCF-1-DB
 cULus Clear Plastic » SCF-1-CP	 cULus Nickel Silver » SCF-1-NS	

TCP-1

TCP-1: 5 3/4" flanged cover, with 2" - 1/2" combo plug for Comm./Data. or single receptacle



Finish Options





 cULus Brass » TCP-1	 cULus Nickel Silver » TCP-1-NS
--	---

TCP-2

TCP-2: 5 3/4" flanged cover, with (2) 1 1/2" screw plugs for duplex power or Comm./Data

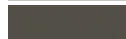

Finish Options



 cULus Brass » TCP-2	 cULus Aluminum » TCP-2-A
 cULus Dark Bronze » TCP-2-DB	 cULus Nickel Silver » TCP-2-NS

TCP-2-LR

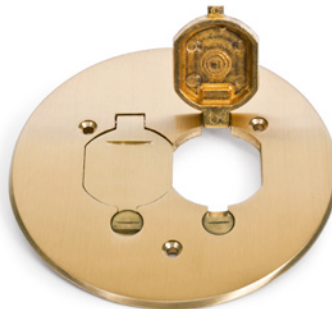
TCP-2-LR: 5 3/4" Seamless flanged cover, with dual flip lid and duplex mounting plate

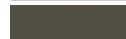

Finish Options

 cULus Brass » TCP-2-LR	 cULus Aluminum » TCP-2-LR-A
 cULus Dark Bronze » TCP-2-LR-DB	

TCP-GR1

TCP-GR1: Brass goof ring for the 32 series; O.D. 7 1/2", I.D. 4"

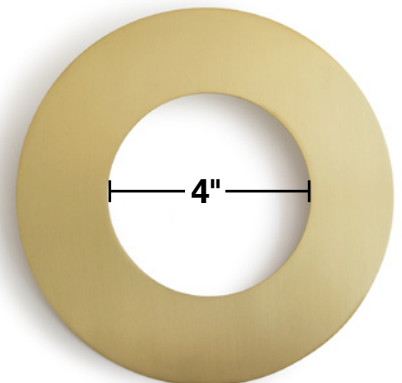

POKE-THROUGH (MOI4)

FEATURES & BENEFITS

- **Totally enclosed and partitioned compartments** for Power / Voice / Data in one unit
- **4 to 10 jacks** for Voice and Data in one unit
- **Threaded conduit openings** reduce the risk of tampering (or need for access to connections) in ceiling space below
- **Completely flush** with 1/4" carpet or other flooring
- Finish available in **Stainless Steel, Brass or Black**
- **Fast, simple installation** (locknut eliminates need for concrete anchors)
- Can be **installed through floor before or after carpet installation**

UL LISTINGS (POKE-THROUGH ONLY)

- » CSA #: 212271
- » Units are UL 514C scrub tested and approved
- » Meets all UL standards required for the U.S.
- » Two-hour fire rating for both the U.S. and Canada



IN-SLAB (MOI-SLB)

FEATURES & BENEFITS

- **Totally enclosed and partitioned compartments** for Power / Voice / Data in one unit
- **4 to 10 jacks** for Voice and Data in one unit
- **Completely flush** with 1/4" carpet or other flooring
- Finish available in **Stainless Steel, Brass or Black**
- Slab Unit can be **poured into slab** for Slab-On-Grade construction

UL LISTINGS (IN-SLAB ONLY)

- » CSA #: 212271
- » Units are UL 514C scrub tested and approved
- » Meets all UL standards required for the U.S.

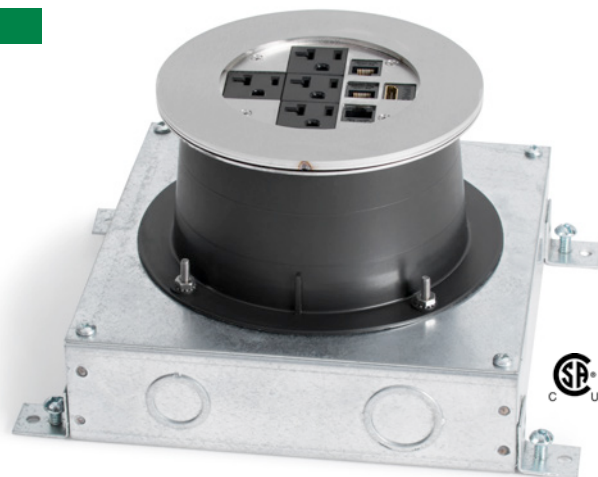

COVER OPTIONS



HOW TO ORDER

STEP 1 » Choose Poke-Through (MOI4) or In-Slab (MOI-SLB)



STEP 2 » Choose Configuration *

*Configuration does not include communication components

	COMM10 » Ten communication openings
	DP1 » Decora receptacle
	DP1-COMM4 » Decora receptacle & (4) communication openings
	PASS-THROUGH » 2.5" trade size circular opening
	PWR2-COMM4 » (2) single receptacle & (4) communication openings
	PWR2-COMM4-DB15 » (2) single receptacle & (4) communication openings & (1) DB-15 opening

	PWR2-COMM5 » (2) single receptacle & (5) communication openings
	PWR2-COMM6 » (2) single receptacle & (6) communication openings
	PWR4 » (4) single receptacle
	PWR4-COMM4 » (4) single receptacle & (4) communication openings
	SYS-COMM » Systems furniture communication-power & comm cabling
	AV-COMM4 » (1) Decora opening for CI-5BWPA & (4) communication openings

EXAMPLE: For Poke-Through » MOI4-COMM10; For In-Slab » MOI-SLB-COMM10

STEP 3 » Choose Cover Finish

	Stainless Steel Add: -SS
	Brass Add: -BR
	Black Add: -BK

Cover Types: Drop Cover Threaded Coin Threaded Security Articulated Hinged Cover Articulated Hinged Cover ¼ Turn
--

STEP 4 » Choose Cover Type

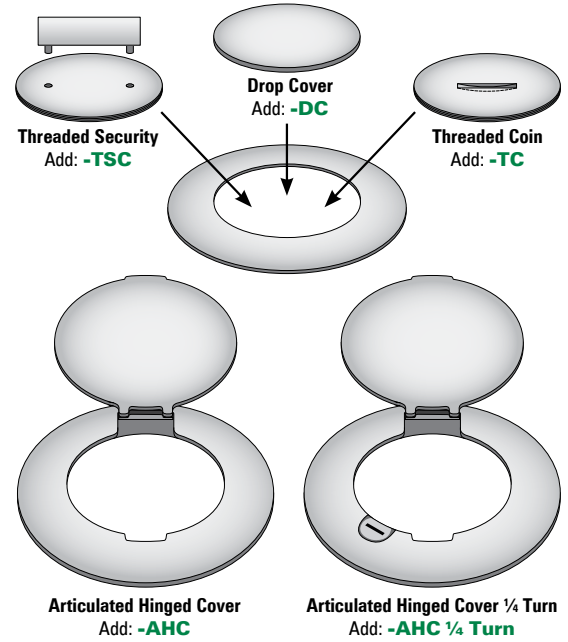

STEP 5 » Specify Slab Thickness

» Must specify when ordering to achieve proper collar size of threaded pipe

EXAMPLE

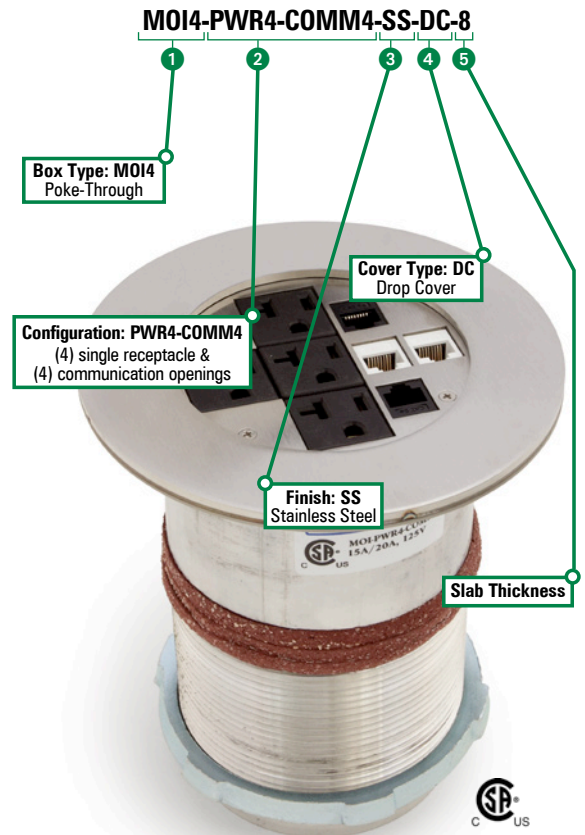

RECESSED POKE-THROUGH (MOI4-REC)

FEATURES & BENEFITS

- **Totally enclosed and partitioned compartments** for Power / Voice / Data in one unit
- **4 to 10 jacks** for Voice and Data in one unit
- **Threaded conduit openings** reduce the risk of tampering (or need for access to connections) in ceiling space below
- **Completely flush** with 1/4" carpet or other flooring
- **Fast, simple installation** (locknut eliminates need for concrete anchors)
- Can be **installed through floor before or after carpet installation**
- Recessed configuration allows for **cover to be closed while in use**

UL LISTINGS (POKE-THROUGH ONLY)

- » CSA #: 212271
- » Meets all UL standards required for the U.S.
- » Two-hour fire rating for both the U.S. and Canada

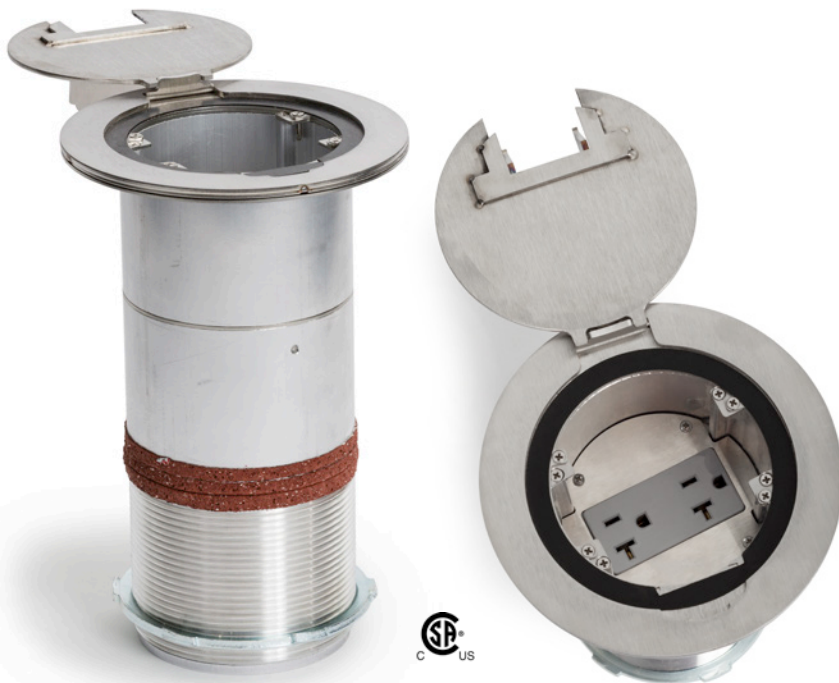

RECESSED IN-SLAB (MOI-SLB-REC)

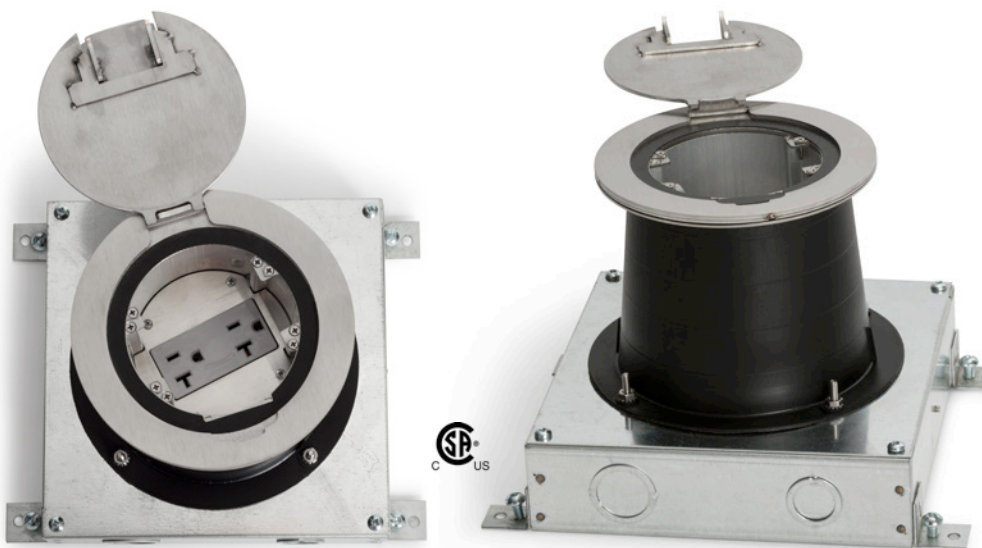

FEATURES & BENEFITS

- **Totally enclosed and partitioned compartments** for Power / Voice / Data in one unit
- **4 to 10 jacks** for Voice and Data in one unit
- **Completely flush** with 1/4" carpet or other flooring
- Slab Unit can be **poured into slab** for Slab-On-Grade construction
- Recessed configuration allows for **cover to be closed while in use**

UL LISTINGS (IN-SLAB ONLY)

- » CSA #: 212271
- » Meets all UL standards required for the U.S.

COVER

Articulated Hinged Cover – Cable Exit Door (AHC-CED) Cover

- » Outer ring diameter = 6"
- » Inner ring diameter = 4.4"
- » Color options: ■ Stainless Steel
■ Brass
■ Black



Articulated Hinged Cover with Cable Exit Door (Stainless Steel shown)

HOW TO ORDER

STEP 1 » Choose Recessed Poke-Through (MOI4-REC) or Recessed In-Slab (MOI-SLB-REC)



STEP 2 » Choose Cover Finish (AHC-CED Cover only for MOI4-REC and MOI-SLB-REC)

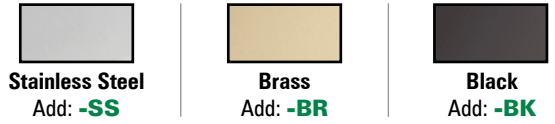

STEP 3 » Specify Slab Thickness

» Must specify when ordering to achieve proper collar size of threaded pipe
 ** Minimum slab thickness for Recessed (MOI4-REC or MOI-SLB-REC) is 6 inches

EXAMPLE



STEP 4 » Choose Configuration *

**Configuration does not include communication components*

	COMM10 » Ten communication openings		PWR2-COMM5 » (2) single receptacle & (5) communication openings
	DP1 » Decora receptacle		PWR2-COMM6 » (2) single receptacle & (6) communication openings
	DP1-COMM4 » Decora receptacle & (4) communication openings		PWR4 » (4) single receptacle
	PASS-THROUGH » 2.5" trade size circular opening		PWR4-COMM4 » (4) single receptacle & (4) communication openings
	PWR2-COMM4 » (2) single receptacle & (4) communication openings		SYS-COMM » Systems furniture communication-power & comm cabling
	PWR2-COMM4-DB15 » (2) single receptacle & (4) communication openings & (1) DB-15 opening		AV-COMM4 » (1) Decora opening for CI-5BWPA & (4) communication openings

EXAMPLE:

For Recessed Poke Through » MOI4-REC-COMM10
 For Recessed In-Slab » MOI-SLB-REC-COMM10



NOZZLES *FDN-250-A*

CATALOG #	DESCRIPTION	DIMENSIONS			STANDARD OPENINGS
		H	L	D	
FDN-250-A	Aluminum floor nozzle (Sand Casted Aluminum)	2 7/8"	4"	2 7/8"	3/4" (Also available in 1/2" or 1", please specify)
203-A ①	Blank nozzle plate				
204-A ①	Nozzle plate for duplex receptacle				
206-A ①	Nozzle plate for single receptacle or cable				
207-A ①	Nozzle plate for GFI receptacle				

① Each Floor Nozzle requires two plates.

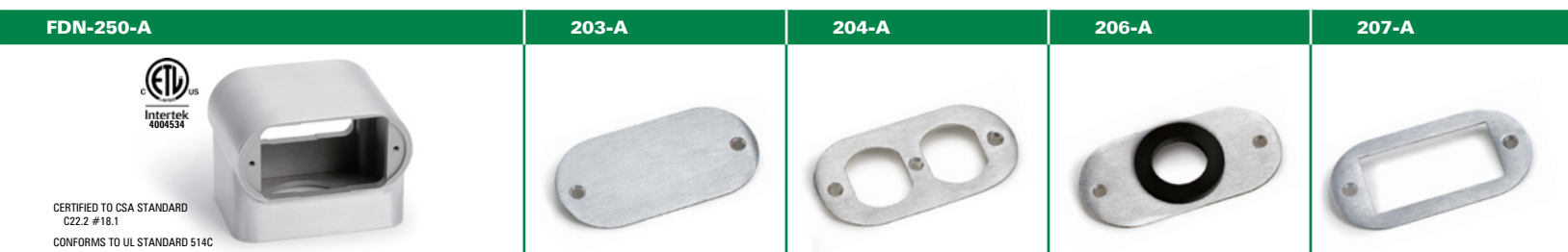

FDN-200-A

CATALOG #	DESCRIPTION	DIMENSIONS			STANDARD OPENINGS
		H	L	D	
FDN-200-A	Aluminum floor nozzle with partition (Die Cast Aluminum)	3"	4 3/4"	4 1/4"	(2) 3/4" (Threaded)
203-A ①	Blank nozzle plate				
204-A ①	Nozzle plate for duplex receptacle				
206-A ①	Nozzle plate for single receptacle or cable				
207-A ①	Nozzle plate for GFI receptacle				

① Each Floor Nozzle requires two plates.



FDN-100-A

CATALOG #	DESCRIPTION	DIMENSIONS			STANDARD OPENINGS
		H	L	D	
FDN-100-A	Aluminum floor nozzle (Die Cast Aluminum) for up to (4) duplex receptacles (not included)	4 3/4"	4 1/4"	4 1/4"	1"
110-A ①	Nozzle plate will accommodate (2) duplex receptacles				
111-A ①	Nozzle plate will accommodate 30-50 AMP receptacle (Internal diameter is 2 1/2")				
112-A ①	Blank nozzle plate				
113-A ①	Nozzle plate will accommodate (2) GFI receptacles				

① Each Floor Nozzle requires two plates.



Replacement Plugs

Product photos not to scale

6410-1/2

6410-1/2: 2"-1/2" combination plug

FITS COVERS:
 6304-S
 524
 TCP-1



Finish Options

Brass » 6410-1/2 Aluminum » 6410-1/2-A

6410-3/4

6410-3/4: Brass 2"-3/4" combination plug

FITS COVERS:
 6304-S-3/4"
 524-3/4



Finish Options

Brass » 6410-3/4

6410-1

6410-1: Brass 2"-1" combination plug

FITS COVERS:
 6304-S-1"
 524-1"



Finish Options

Brass » 6410-1

6208

6208: 1/2" close up plug

FITS COVERS:
 6304-S
 524
 TCP-1



Finish Options

Brass » 6208 Aluminum » 6208-A

6210

6210: 3/4" close up plug

FITS COVERS:
 6304-S-3/4"
 524-3/4



Finish Options

Brass » 6210

6211

6211: 1" close up plug

FITS COVERS:
 6304-S-1"
 524-1"



Finish Options

Brass » 6211

6212

6212: 1 1/4" close up plug

FITS COVERS:
 RRP/SWB-2 or -4



Finish Options

Brass » 6212 Aluminum » 6212-A
 Nickel Silver » 6212-NS

6213

6213: 1 1/2" close up plug (duplex covers)

FITS COVERS:
 523-DP (812)
 6304-DP (1101)
 TCP-2



Finish Options

Brass » 6213 Aluminum » 6213-A
 Dark Bronze » 6213-DB Nickel Silver » 6213-NS

6213-BP

6213-BP: Plated 1 1/2" close up plug (for RRP-1-BP & SWB-1-BP **ONLY**)

FITS COVERS:
 RRP-1-BP
 SWB-1-BP



Finish Options

Brass Plated » 6213-BP Nickel Plated » 6213-NP
 Dark Bronze Plated » 6213-DBP

6214

6214: 1 1/4" plug for RCFB series

FITS COVERS:
 RCFB-1
 RCFB-2



Finish Options

Brass » 6214 Aluminum » 6214-A
 Dark Bronze » 6214-DB

6215

6215: 1 1/2" close up plug

FITS COVERS:
 PBR-SPB
 RRP-2-SPB
 RRP-4-SPB
 RRP-6-SPB



Finish Options

Brass » 6215 Aluminum » 6215-A
 Dark Bronze » 6215-DB

LEW ELECTRIC FITTINGS COMPANY

1626 Tobacco Rd.
 Augusta, GA 30906

Ph: 877-537-2019

www.lewelectric.com