

SPACEWALKER II



1/4 Scale



Craftman's Kit
SIGRC59

BUILDING AND FLYING INSTRUCTIONS

Sig Mfg. Co., Inc....401-7 South Front Street....Montezuma, Iowa 50171

The Spacewalker II Story

In 1986, inspired by the classic PT-19 and Ryan military trainers of WWII, North Carolina EAA member Jesse Anglin designed and built an open-cockpit, low-wing, single-place airplane for his own personal sport flying. To make it more economical to fly, he sized it around a Continental 65 h.p. engine. Jesse always said that his new airplane gave him the feeling of being in open space, almost as if he was flying without an airplane, and that's why he named it Spacewalker. In the years since then, the single-place Spacewalker has attracted a lot of attention from both homebuilders and R/C modelers alike.

Two of the first full-scale Spacewalkers to take to the air after Jesse's own, were built by Sig Mfg. executives Hazel Sig and Maxey Hester. As Hazel and Maxey flew around the country in their single-place Spacewalkers, they got the same question everywhere they went, "What about a two-place version?"

With that in mind, Jesse went back to the drawing board and designed the Spacewalker II. The new two-place airplane featured the same general construction as the original, with a welded steel tube fuselage and a wood wing. To accommodate the extra passenger, Jesse added 13 inches to the overall fuselage length, and extended the wingspan 24 inches longer than the single-place.

Maxey and Hazel built the first prototype Spacewalker II in the Sig factory, using a 65 h.p. Continental for power. In order to get it ready for the rapidly approaching 1990 Sun-N-Fun Fly-In in Lakeland, Florida, they sparyed on a quick and simple red and white paint scheme. Then with only a few hours on the aircraft, Jesse came to Montezuma to fly it down to Florida, flying in formation with Hazel and Maxey in their two single-piece Spacewalkers. You can read all about their trip to Sun-N-Fun in the September 1990 issue of "Kitplanes" magazine, and in the July 1990 issue of "Sport Aviation" magazine.

In the winter of 1991, Maxey brought the Spacewalker II back into the Sig factory to install a 100 h.p. Continental 0-200 engine for better performance. At the same time, the simple red/white color scheme was removed and the more familiar yellow and red Spacewalker-style color scheme was put on.

Unable to keep up with the demand for plans for his two popular designs, Jesse Anglin sold all of his rights and interest in the Spacewalker and Spacewalker II in September of 1991 to Rick Warner of Tampa, Florida. For futher information on either of these full-scale homebuilt aircraft contact:

WARNER AEROCRAFT
7801 N. Armenia Ave.
Tampa, Florida 33604.

COMPLETE KIT PARTS LIST

COMPLETE KIT PARTS LIST				
Die-Cut Balsa Sheets				
2	3/32"x4"x18" W-1 Wing Ribs Sheet #5	4	3/32"x4"x18" W-2 Wing Ribs Sheet #4	7 3/32"x4"x18" W-3 Wing Ribs Sheet #3
1	3/32"x3"x18" F-1, F-2, F-3 Formers Sheet #6	1	3/32"x3"x18" F-4, F-5, F-6A Formers Sheet #7	1 1/8"x3"x12" FS-1 Sheet #1
Sheet Balsa				
4	3/32"x1-1/2"x21" Top Wing & Aileron Sheeting, Wing Aileron cutout Sheeting	4	3/32"x2-1/2"x42" Wing Leading Edge Sheeting & Servo Bay Sheeting	4 3/32"x3"x30" Wing Center Sheeting & Top Deck Side Sheeting
24	3/32"x3-5/16"x1-3/4" Spar Webs	2	1/8"x1-1/2"x21" Aileron Leading Edge	1 3/16"x6"x4" Landing Gear Fill-In
Stick Balsa				
1	3/32"x1/8"x18" Top Main Spar Spacers	16	3/32"x1/4"x30" Cap Strips	4 3/32"x1/2"x21" Bottom Wing & Aileron Sheeting
4	1/8"x3/16"x21" Aileron Spars	7	1/8"x3/16"x36" Balsa Fill Straps	7 1/8"x1/4"x36" Top Stringers, Side Stringers
2	1/8"x3/4"x42" Leading Edge	12	3/16"x3/16"x30" Main Frame, Braces for Fin & Servo Mount Plate	4 3/16"x3/16"x42" Forward Spars Top & Bottom
2	3/16"x3/4"x42" Leading Edge Cap	2	1/4"x1/4"x24" Front Top Stringers	3 5/16"x5/16"x30" Tail Surface Ribs
2	5/16"x1"x2-5/8" Trailing Edge Support	1	1/2" Triangle x 6" Braces for Rear L.G. Blocks	1 3/4" Triangle x 24" Braces for Firewall and PW
Silkscreened Balsa				
1	3/16"x3"x42" WS-1, WS-2, WS-3 & WS-4 Sheet #9	1	5/16"x3"x24" All Rudder, Stab, Elevator, and Fin Parts Sheet #8	
Block Balsa				
1	3/8"x1-1/8"x6-1/2" Trailing Edge Fill-In Block	2	1/2"x2-3/4"x7/8" Landing Gear Support Blocks	
Hardwood				
1	5/16"x3/4"x1-1/8" Basswood Control Horn Mount	2	3/4"x3/4"x1-1/2" Basswood Wing Hold Down Block	1 3/8"x3/8"x12" Basswood Servo Rails
2	3/8"x3/4"x3" Basswood Front L.G. Blocks Grooved	2	3/16" dia. x 2-1/2" Birch Dowels Pushrod Ends	2 1/4" dia. x 1-1/4" Birch Dowels Wing Hold Down Dowels
Spruce				
1	1/8"x1/2"x14" Hatch Cover Support	5	3/16"x3/16"x36" Fuselage Main Frame	1 1/4"x1/2"x6" Tiller Bar Mount
1	5/16"x5/16"x5" Elevator Joiner			6 1/4"x1/2"x40" Main Spars, Spar Doublers
Die-Cut Poplar Plywood (Lite Ply)				
2	1/8"x6-7/8"x26" PS-1, PS-2	1	1/8"x6-7/8"x24" PT-1	1 1/8"x8"x13-3/4" F-6, F-7, F-8, F-9, F-10, Servo Mount Plate, G-1, TWM, PB-1, Wing Saddle Carving Guage, Dihedral Guage
				2 1/8"x8"x13-3/4" W-1A, PF, W-3A, WTP, SW-1, SW-2, SW-3, SW-4

Die-Cut Birch Plywood							
1	1/16"x8"x8" Wheel Pant Mount Plate, Front & Rear Instrument Panels	1	3/32"x6"x9" Hatch Covers, L.G. Mounts, PW, Wing Hold-Down Plates	2	5/32"x8"x8" F-1	1	5/32"x3"x13-1/2" DB-1, DB-2
Sawn Plywood							
2	1/64"x7/8"x36" Birch Plywood Wing Straps						
Wire Parts							
1	3/32" dia. x 8" Straight Wire for Servo End of Elevator Pushrod	1	1/8" dia. x 6-3/4" Formed Top Shock Strut Wire	1	1/8" dia. x 15-11/16" Formed Bottom Shock Strut Wire	1	3/16" dia. x 22" Formed Front Main L.G. Wire
1	3/16" dia. x 19-5/8" Formed Rear Main L.G. Wire						
Plastic Parts							
1	Left Dummy Engine Cylinders	1	Right Dummy Engine Cylinders	1	Cylinder Shrouds, Fuel Cap Cover, Shock Springs, Compass	2	Wheel Pant Halves (Left-Hand)
2	Wheel Pant Halves (Right-Hand)	1	Left Wingtip	1	Right Wingtip	1	Cowling Half (Left-Hand)
1	Cowling Half (Right-Hand)	1	.030x5/16"x17" ABS Cowl Joiner Strip				
Miscellaneous Parts							
2	.030x5"x12" Clear Plastic Windshields	1	1/2" dia. x3" White Foam Cockpit Coaming, Grooved	1	3/32" wide x7" Cockpit Lacing	1	32" Long Fiberglass Pushrod Shaft (for elevator)
1	9-1/4"x12" 6oz Fiberglass Cloth (for Landing Gear)	1	2"x30" Fiberglass Tape (for Wing Joint)	1	.130 o.d. x20" Nylon Tubing (for Rudder Cable Guides, Throttle Pushrod)	1	1/16"x20" Steel Cable (for Throttle Pushrod)
1	Full-Size Plans Plate 1	1	Full-Size Plans Plate 2	1	Full-Size Plans Plate 3	1	Instruction Book
1	Decal Sheet	2	3/1/2"x21" White Offset Paper for Servo Leads	3	8-1/2"x11" 3-View Drawings		
Hardware Pack							
12	#2x3/8" Sheet Metal Screws (for Tail Brace Wires, Servo Hatch Covers)	2	#2x3/4" Sheet Metal Screws (for Elevator Horn)	4	#4x3/8" Sheet Metal Screws (for Wheel Pant Mounts)	8	#4x1/2" Sheet Metal Screws (for L.G. Straps)
6	2-56 x 1/2" Mounting Bolts (for Tail Brace Wires, Rudder Horn)	4	4-40 x 3/16" Mounting Bolts (for Aileron Servo Mounts)	1	6-32 x 1" Mounting Bolt (for Tiller Bar)	6	4-40 x 1/2" Self-Tapping Bolts (for Cowling)
2	6-32 x 3/8" Socket Head Bolts (for Wheel Pant Mounts)	4	10-32 X 1" Socket Head Bolts (for Engine Mount)	6	2-56 Hex Nuts (for Tail Brace Wires, Rudder Horn)	4	4-40 Blind Nuts (for Aileron Servo Mounts)
4	10-32 Blind Nuts (for Engine Mount)	6	4-40 Brass Threaded Inserts (for Cowling)	1	6-32 Aircraft Lock Nut (for Tiller Bar)	4	#3 Flat Metal Washers (for Aileron Mount)
2	#6 Flat Metal Washers (for Tiller Bar)	6	#8 Flat Metal Washers (for Wheel Spacers)	2	1/4"x20"x1" Nylon Wing Bolts	15	Hinges
15	#28 Steel Pins (for Hinges)	3	2-56 Threaded Couplers (2 Rudder, 1 Throttle)	3	2-56 Nylon R/C Links (2 Rudder, 1 Throttle)	1	2-56 Solder Link (for Throttle)
4	4-40 x 8" Threaded Rod (1 Elevator, 1 Rudder, 2 Ailerons)	4	4-40 Metal R/C Links (1 Elevator, 1 Rudder, 2 Ailerons)	4	4-40 Solder Links (1 Elevator, 1 Rudder, 2 Ailerons)	1	Large Righthand Nylon Control Horn (for elevator)
2	Molded Nylon 90 deg. Bellcranks (for Aileron Control Horns)	4	Large Molded Nylon Landing Gear Retaining Straps	2	3/16" I.D. Molded Nylon Wheel Pant Mounts with Brass Inserts	1	Molded Nylon Heavy-Duty Rudder Control Horn
1	Molded Nylon Heavy-Duty Tiller Bar	1	.027 x 200" roll Steel Cable (for Rudder Control and Tail Brace Wires)	1	21" roll Soft Copper Wire (for wrapping Landing GearWire)	2	3/16" Wheel Collars (for Main Landing Gear)
2	6-32 x 1/8" Headless Set Screws (for Wheel Collars)	14	Steel Brace Wire Attach Tabs	10	3/32" o.d. x 1.2" Aluminum Tubing (for Tail Brace Wires)		
Tail Wheel Assembly							
1	#1 Formed Steel Leaf Spring	1	#2 Formed Steel Leaf Spring	1	3/32" dia. x 3-1/8" Formed Tailwheel Wire	1	Molded Nylon Tailwheel Bearing 3/32" hole
1	Molded Nylon Tailwheel Steering Arm	2	6-32 x 1/2" Mounting Bolts	2	6-32 Square Anchor Nuts	2	4-40 x 3/8" Mounting Bolts
2	4-40 Aircraft Lock Nuts	1	4-40 x 3/16" Set Screw	2	3/32" Wheel Collar	2	C.B. #5511 Steering Springs
2	#2 Flat Washers	1	4-40 Headless Set Screw				

GLUES

There are many different glues available today for model construction that it can be confusing to even the experienced modeler. To simplify matters, most glues can be classified as one of four basic types:

1. Fast cyanoacrylate adhesives (abbreviated as C/A) such as Sig CA, Hot Stuff, Jet etc.
2. Easy to use water-based wood glues such as Sig-Bond (yellow) and Sig Super-Weld (white).
3. Super strong (but heavier) two-part epoxy glues such as Sig Kwik-Set (5 minute cure) and Sig Epoxy (3 hour cure).
4. Traditional solvent-base model cements such as Sig-Ment.

Each of these types has different characteristics and advantages. Often times, the choice of which type to use is strictly a matter of personal preference based on your experience with a previous model. To help speed up assembly, C/A glue is recommended for general construction. You should also have on hand some epoxy (both 5 min. and slow dry) and Sig-Bond because these glues are called out in several places in these instructions.

Sig CA, like most brands of cyanoacrylates, come in three viscosities- thin, medium, and thick. An accelerator spray and debonder are also available and are described below.

- **Sig CA Thin** - Watery consistency, thin CA should only be used when the two parts to be joined are in perfect contact with zero gap. Capillary action pulls this glue deep into the wood resulting in a very strong bond and it dries in just a few seconds. Thin CA can be used to tack assemblies together, but these joints should be glued again later with medium or thick CA.
- **Sig CA Medium** - Our medium thickness CA is excellent for almost any step during construction. The extra thickness allows the glue to fill small gaps, but it does dry a little slower than a thin CA. If you want only one type of C/A, use medium thickness.
- **Sig CA Slow** - This thickest formula is good for filling large gaps and building up strong fillets at joints requiring extra strength. It also dries slow enough to allow you to apply it to one part and position it on another before it dries. (With the thin and medium C/A's, the parts must be in contact and positioned correctly before glue application.) This feature is useful when laminating large sheeted areas like a fuselage side and a fuselage doubler.
- **Sig Kwik-Shot Accelerator** - Spraying accelerator on CA (any thickness) will cure it almost instantly. Although CA is fast, it's sometimes nice to speed it up even more.
- **Debonder** - This can be used to separate parts, but you'll probably use it for unsticking your fingers more than anything else!

CAUTION: Some people have experienced allergic reactions when exposed to epoxy or cyanoacrylate glues. This is very rare. However, it is extremely important that such glues, and also paints, thinners and solvents, be used with adequate ventilation to carry fumes away.

NOTES BEFORE BEGINNING CONSTRUCTION

Any references to right or left refers to your right or left as if you were seated in the cockpit.

To build good flying models, you need a good straight building board. Crooked models don't fly well! The building board can be a table, a workbench, a reject "door core" from the lumber yard, or whatever- as long as it is perfectly flat and untwisted. A 2ft.x6ft. board is recommended for the Spacewalker II.

Cover the top surface of the building board with a piece of celotex-type wall board or foam board, into which pins can be easily pushed. Don't hesitate to use plenty of pins during assembly to hold drying parts in their correct position.

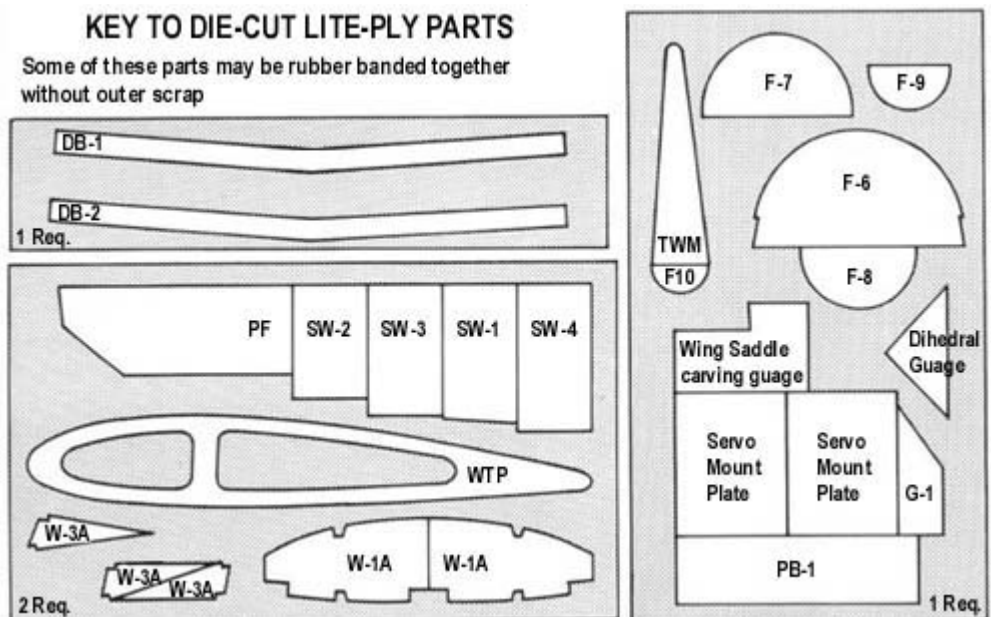

When pinning or gluing parts directly over the full-size plans, cover the plan with wax paper or plastic kitchen wrap to prevent gluing the parts to the plans.

The balsa die-cut parts have identification numbers printed on them. The plywood die-cut parts do not. Use the "Key to Plywood Parts" to mark the identification numbers on the corresponding plywood parts.

Leave all the die-cut parts in the sheets until needed for construction. Remove pieces from the sheets carefully. If difficulty is encountered, do not force the part from the sheet. Use a modeling knife to cut it free.

All of the other kit parts can be identified by the "Complete Kit Parts List".

Sort the different sizes of sticks and sheets into individual piles to avoid confusion during building. Cut all long pieces of balsa first, followed by medium lengths, before cutting up any full length strips into short pieces.

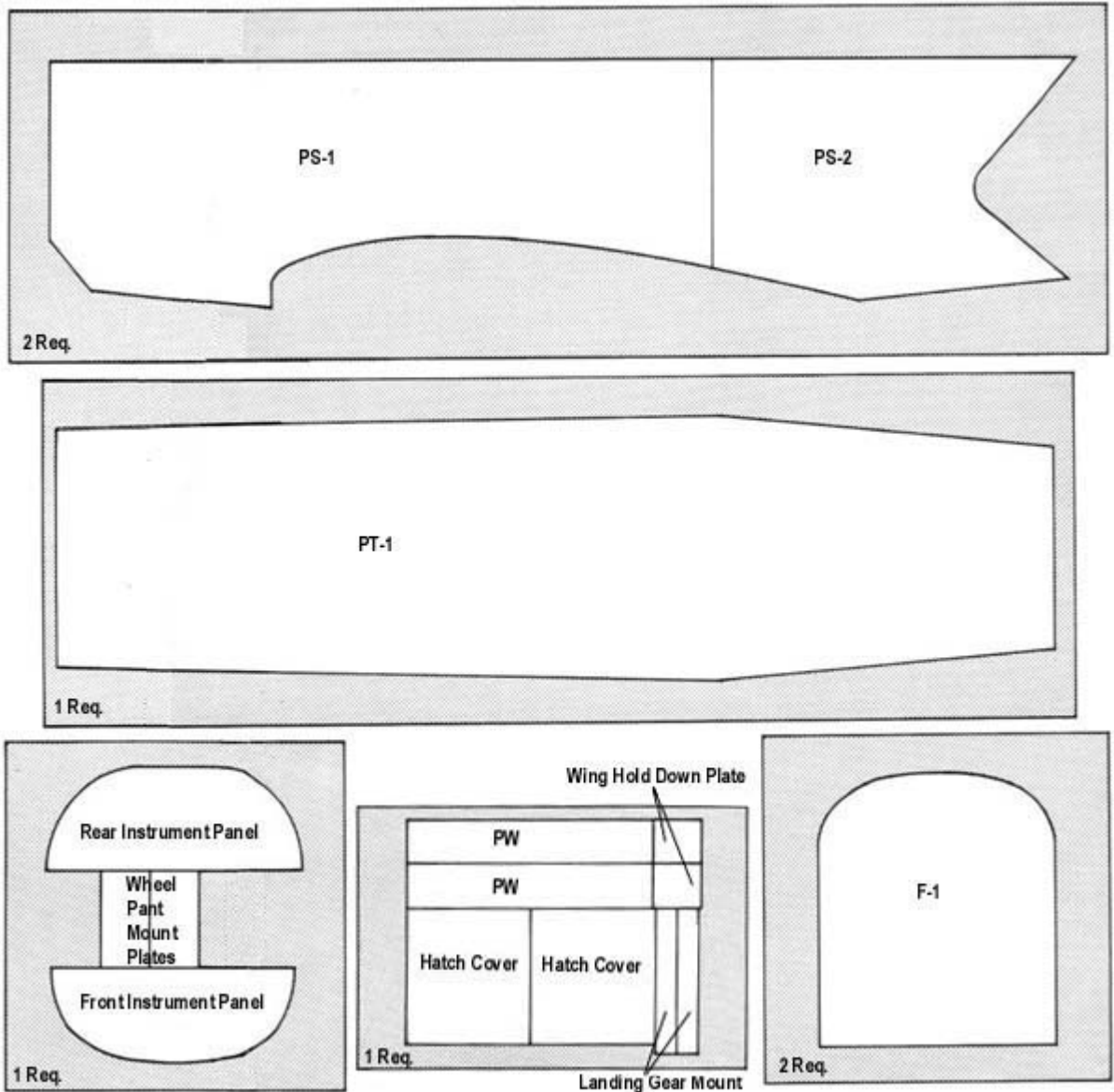

YOU CAN'T GET ALONG WITHOUT A GOOD SANDING BLOCK

An assortment of different size sanding blocks are indispensable tools for model construction. A good general purpose block can be made by wrapping a 9"x11" sheet of sandpaper around a piece of hardwood or plywood. Use three screws along one edge to hold the overlapped ends of the sandpaper. Put 80-grit paper on the block during general construction. Switch to 220-grit paper for final finish sanding just before covering.

Another handy block can be made by gluing sandpaper onto a 24" or 36" long piece of aluminum channel stock. Most hardware stores carry a rack of aluminum in various sizes and shapes. This long block is very useful for sanding leading and trailing edges accurately.

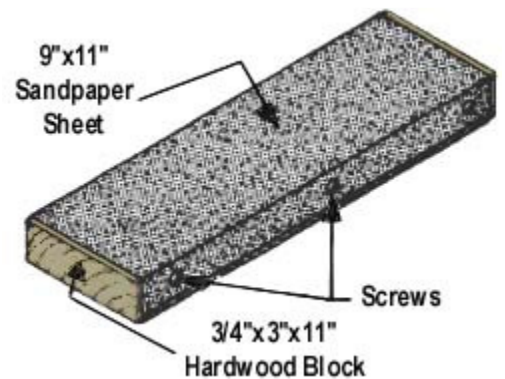

ABOUT THE BUILDING SEQUENCE

The quickest and most efficient way to complete a model is to work on several pieces at the same time. While the glue is drying on one section, you can start on or proceed with another part. Work can even go forward on several sections of the same assembly at the same time, such as the front and rear sections of the fuselage.

Keep in mind that the numbering sequence used in these instructions was chosen as the best way to explain the building of each major component and is not intended to be followed exact one-two-three fashion. Start on the wing at No.1 and after doing as many steps as is convenient, flip over to "Fuselage Construction" and do a step or two or three, then over to "Tail Assembly" and so forth. You will, of course, arrive at points where you can go no farther until another component is available. For example, you need a nearly completed wing before the fuselage can be entirely completed. Plan ahead! Read the instructions completely and study the full size plans before beginning construction.

RADIO REQUIREMENTS

You will need at least a four-channel radio system for your Spacewalker II to operate the ailerons, elevator, rudder and throttle. Heavy-duty servos with at least 60oz./in. of torque are required for all of the flight controls. Also, use a receiver battery with at least a 1000 mAH capacity to power those servos for a safe amount of time. Be certain that your radio system's frequency is approved for use in R/C model aircraft. Using a frequency assigned to R/C model cars not only endangers your model to interference from model car drivers (who may not be in sight), it also is against the law.

ABOUT PRINTED WOOD PARTS

To answer the question we are sometimes asked - no, we do not print parts on wood to save money. It is actually more expensive to print the parts using a silk screen press than it is to run an equivalent sheet through our automatic feed die cutting machine. If we hand-sawed the parts it would be even more expensive and the labor cost would have to be added to the kit price. We believe that most modelers would rather cut their own out and save the cost. Since there are not many thick parts in our average kit, it really doesn't consume a lot of the total building time for the builder to do the parts.

WING CONSTRUCTION

Wing Subassemblies

Before beginning construction on the wing, there are a number of subassemblies that should be built and set aside until needed. This is done to avoid interruptions during the flow of the wing construction.

- Cut four 1/4"x1/2"x19-1/4" spruce spar doublers from two of the 1/4"x1/2"x40" spruce sticks provided with the kit.
 - The main spar assemblies are built by laminating a 1/4"x1/2"x40" spruce main spar with a spar doubler (from part a of this step). Build four main spar assemblies using a thin film of slow-drying epoxy to join each laminate. It is very important that the main spar assemblies be kept perfectly straight while drying. Any bends or twists built in now are there to stay.
- Join two die-cut 1/8" lite-ply W-1A sub-ribs to two W-1 ribs, being certain to make one left and one right. These subassemblies will serve as the two center ribs in the wing center section. The remaining two W-1A sub-ribs are not installed until the wing has been fitted to the fuselage.
- Use scrap pieces of 1/16" balsa to join four W-3A sub-ribs to four W-3 wing ribs, being certain to make two left-hand and two right-hand. These subassemblies are used at the inboard and outboard ends of each aileron.



Wing Construction

The wing is built in two halves, which are joined later to complete the wing. Pin down the plan on your building board and cover it with wax paper.

4.
 - a. Pin down one of the laminated spruce main spar assemblies over the plans, being careful to position the outboard end of the spar doubler correctly.
 - b. Glue and pin all of the 3/32" balsa wing ribs into position except for the W-1/W-1A subassembly at the wing center. Be sure to use the wing rib subassemblies that you prepared earlier in step 3.

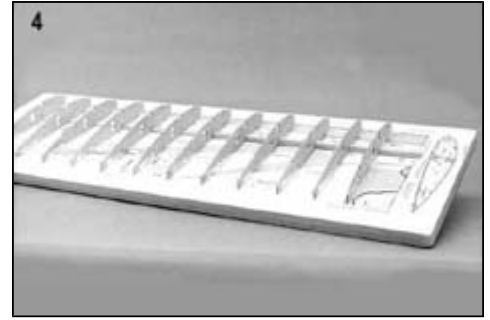

5. Glue another laminated spruce main spar assembly to tops of the ribs. Use a builder's triangle to make certain each rib is vertical.
6. Locate the die-cut 1/8" lie-ply dihedral gauge. Position the W-1/W-1A wing rib assembly in its position on the plans using the die-cut lite-ply dihedral gauge to insure that it is at the proper angle. Glue the rib assembly to the spars.

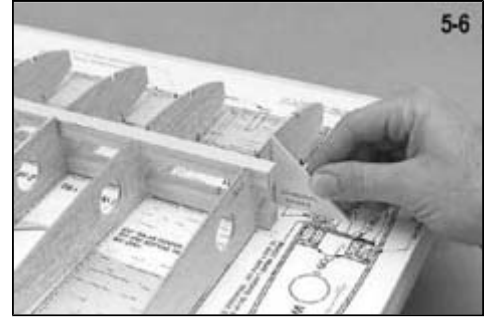

7. Glue a 3/16" sq. x 42" balsa forward spar in place on top of the ribs.
8. Glue the 1/8" x 3/4" x 42" balsa leading edge in place at the front of the ribs.

9. Glue in two 3/16" x 3/8" x 42" balsa rear spars. You will have to slide the bottom spar under the ribs and lift it in position.

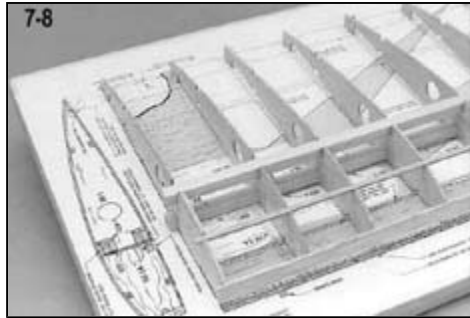

10. Attach a 3/32" x 1" x 42" balsa trailing edge sheet in place on top of the wing ribs. Careful! Make sure that the back edge of the sheet is in the right place, directly above the trailing edge on the drawing.

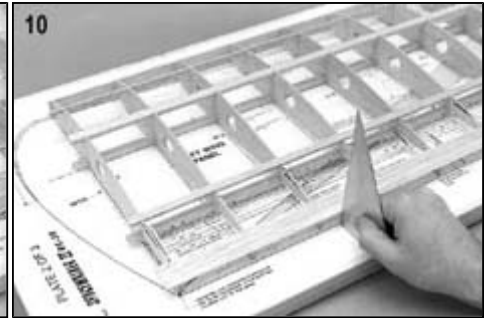

11. Trim and glue all of the spar webs on the front side of the main spars. SW-1, SW-2, SW-3, and SW-4 are all die-cut lite-ply; the remaining spar webs are 3/32" x 3-5/16" x 1-3/4" pre-cut balsa. (No spar webs should be installed on the backside of the spars now because you will need to get at the pins in the bottom spar when it is time to remove the wing from the building board.)

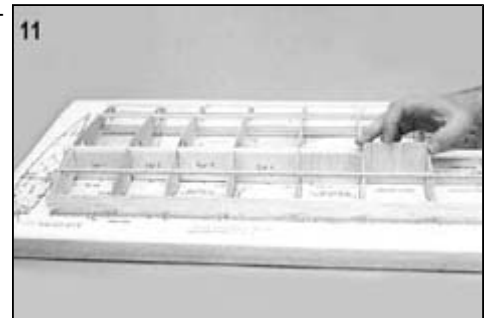

12.
 - a. Sand the top of the leading edge to the contour of the ribs. Be careful to avoid sanding the ribs and changing their shape.
 - b. The leading edge is sheathed with 3/32" x 2-1/2" x 42" balsa. The sheathing should overlap onto the forward spar only halfway. Start gluing at the spar and work forward to the leading edge, pinning or taping the sheet in place as you go. There will be excess sheathing forward of the leading edge to carve and sand later.

13. Fill the gap on the tops of the W-2 and W-3 wing ribs above the spar with spacers made from short lengths of 3/32" x 1/8" x 18" balsa. The spacers on top of the W-1 ribs will be added later. When dry, sand the spacers even with the tops of the ribs.



14. Cut two 1/8" x 3/16" x 21" balsa aileron spars to the correct length and glue them to the wing, one on top and one on the bottom.

15. Use a 3/32" x 1-1/2" balsa sheet for the top aileron sheathing. Glue this sheet to the top of the wing as shown. This sheet will eventually be sliced down its length when the aileron is cut from the wing.

16. Glue the 3/32" x 1/4" balsa capstrips to the tops of the wing ribs and aileron ribs as indicated on the plan.

17. A paper tube to pass the servo leads is made from the 3-1/2"x21" sheet of paper provided. Roll the paper, insert it through the rib holes, and glue it to the ribs. When dry, remove the wing from the building board.

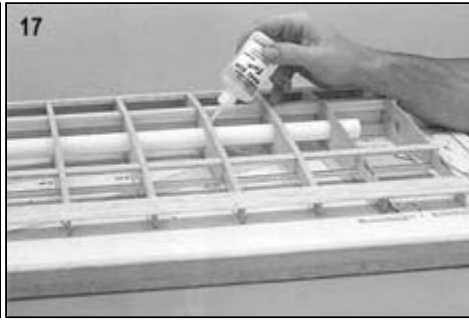
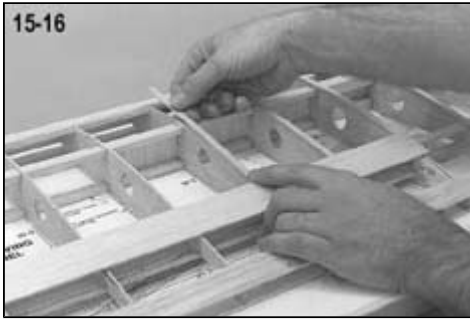

BUILDER'S TIP

Now is a good time to look over your basic wing structure for any joints that may need another coat of glue. In particular, inspect the bond at all the rib/spar/web joints.

18. Glue in the remaining seven balsa spar webs to the back of the main spar.

- 19.
- Carefully cut away all of the rib alignment tabs, then sand the bottom of the ribs and the rear edge of the trailing edge sheeting to the airfoil shape.
 - Glue the 3/32"x1"x42" balsa trailing edge sheeting to the bottom of the wing. Use epoxy glue where the bottom sheeting joins the top sheeting. The epoxy will not warp the trailing edge (as water-based glues might) and will strengthen the sharp edge so that it is not easily damaged.

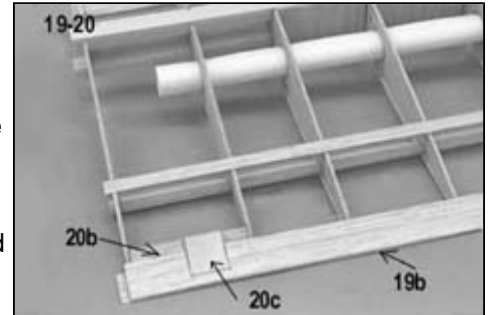

- 20.
- Notch the bottom trailing edge sheeting in the position shown on the plan for the die-cut 3/32" plywood wing hold-down plate.
 - Cut the 3/8"x1-1/8" special-cut balsa trailing edge fill-in block to fit between the W-1 ribs and glue it in place.
 - Glue the wing hold-down plate to the fill-in block at the notch that you made in "part a" of this step.

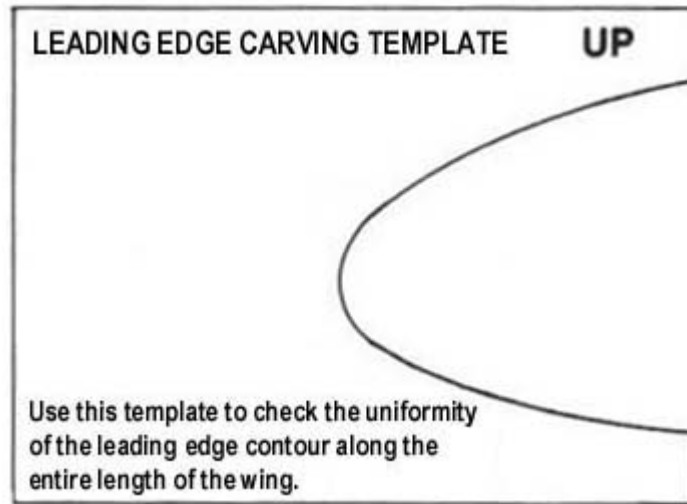

- 21.
- Add the 3/16" sq. balsa forward bottom spar.
 - Sand the leading edge to the bottom contour of the wing as you did in step 12.
 - Cut a 3/32"x2-1/2"x42" balsa sheet to a length of 36". Save the scrap for step 23c.
 - Glue the 3/32"x2"x38" balsa bottom leading edge sheeting in place in the same manner as the top leading edge sheeting. Notice that the sheeting will end up about an inch short of the wing center. Later the sheeting will be cut away even further.

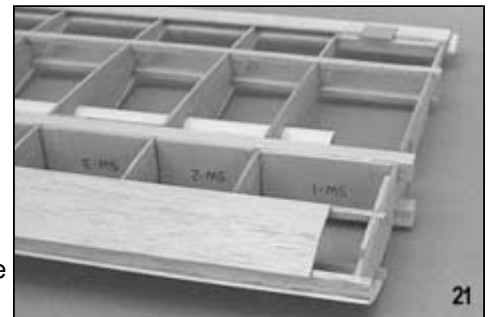

- 22.
- When dry, trim the excess top and bottom sheeting flush with the front of the leading edge.
 - Glue the 3/16"x3/4"x42" balsa leading edge cap to the front of the wing. Use tape or pins to hold the leading edge cap flat. Let dry.
 - Carve and sand the leading edge cap to the shape shown on the plans. Take your time with this step and try to keep the shape uniform along the entire leading edge. Cut out the Leading Edge Carving Guide and glue it to scrap balsa or light cardboard to check the shape at random spots along the leading edge.

23. a. Add the 3/32"x1/2"x21" balsa bottom wing sheeting.
 b. Add the 3/32"x1/2"x21" balsa bottom aileron sheeting.
 c. Use the piece of 3/32"x2" balsa sheet from step 21c for the servo bay sheeting. Make the pushrod exit cutout as shown on the plan, then glue this sheeting to the bottom wing surface only.
 d. Glue in all the 3/32"x1/4" balsa capstrips on the wing bottom.

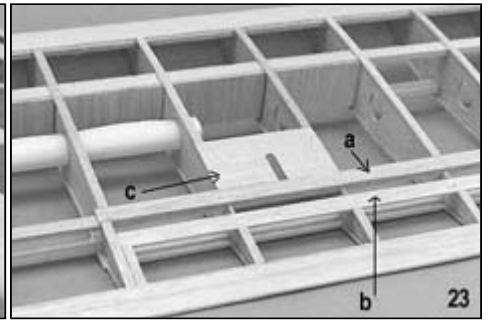
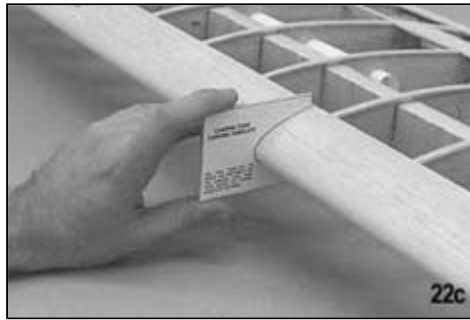

BUILDER'S TIP

Check to make sure that your servo will work with the pushrod exit cutout that is shown on the plans. We used Airtronics #94732 servos and these cutouts worked well. Depending on the size of your servos, you may need to move the cutout right or left of center. Remember to reposition the W-3A rib to line up the control horn with the pushrod exit cutout.

24. a. Cut two 1/8"x1/2"x3-1/4" spruce hatch cover supports from the 14" spruce stick provided.
 b. Glue in the rear support so that it fits under the edges of the capstrips and overlaps the forward edge of the servo bay sheeting by 1/4". The forward support is glued to the back of the balsa spar web with its ends under the edges of the capstrips.
 c. Trim a die-cut 3/32" plywood hatch cover to fit between the capstrips. While holding the hatch cover in place, glue a 3/32"x1/4" balsa strip to the front edge of the forward spruce support to give the covering material a place to attach. Don't glue the hatch cover!
 d. Drill 1/16" dia. holes through the corners of the hatch cover into the hatch supports. Remove the hatch cover, then redrill the holes in the hatch cover with a 3/32" drill bit. The hatch cover is held on with four #2 x 3/8" sheet metal screws. Be sure to mark each cover so you can tell later which hatch goes with which wing!
25. Saw out the aileron using a razor saw to cut through the ribs. Exactly where you cut is not critical as long as it's somewhere between the rear spars and the aileron spars. Cut through W-3 rib on the outboard end of the aileron, then remove and discard the part remaining attached to the aileron. Use a sharp modeling knife to cut the top aileron sheeting and temporary spacers on the inboard end.

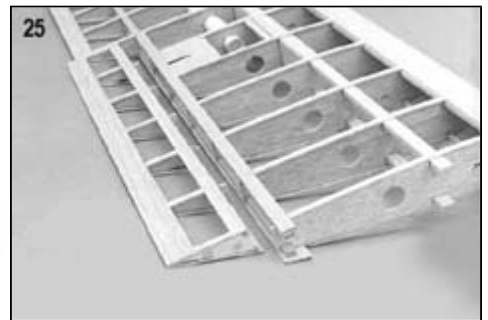
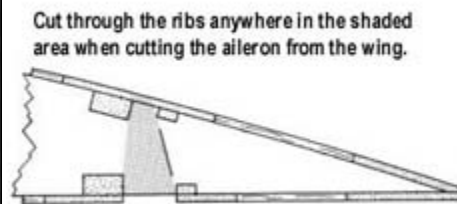
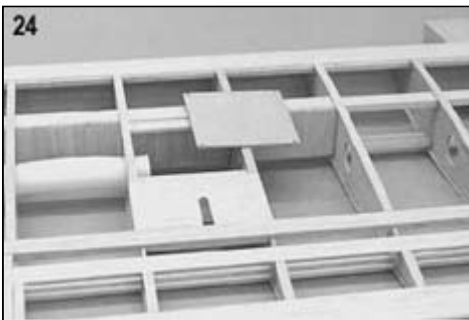

26. a. Trim and sand the back of the wing cutout until the ribs are even with the rear spars. Use a long sanding block to sand just enough to make the back edge flat, as shown.
 b. Sheet the back of the wing cutout with 3/32"x1-1/2"x21" balsa, cut to length. When dry, trim the sheeting to airfoil contour.
27. a. Sand the outboard end of the wing bringing all spars, leading edge and trailing edge flush with the end rib.
 b. Glue the die-cut lite-ply WTR wingtip rib to the end of the wing.
 c. The ABS wingtip can be glued to the wing using CA. Be sure to clean and lightly sand the inside of the ABS where the glue will come in contact. Notice that the wingtip overlaps only onto WTR when glued in place. Also notice that WTR does not extend all the way back to the rear point of the wingtip. The small gap that remains can be left as is or filled with scrap balsa or model filler.
 d. Feather the wingtip into the wing using model filler.

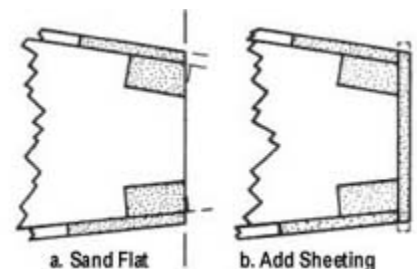

28.
 - a. Trim and sand the front of the aileron in line with the angled, die-cut slits in the ribs.
 - b. Add the 1/8"x1-1/2"x21" balsa aileron leading edge.
 - c. When dry, sand the aileron leading edge to shape.
 - d. Sand each end of the aileron flat.

29.
 - a. Glue in the W-3A aileron rib in the position shown on the plans. The aileron rib may need some trimming to slip into place.
 - b. The aileron control horn is actually a 90 deg. bellcrank. Cut a slot in the aileron leading edge, just large enough for one arm of the horn, then epoxy the horn firmly in place on the W-3A rib. See the "Wing Rib Cross Section" on the plan to see exactly how the horn is positioned.

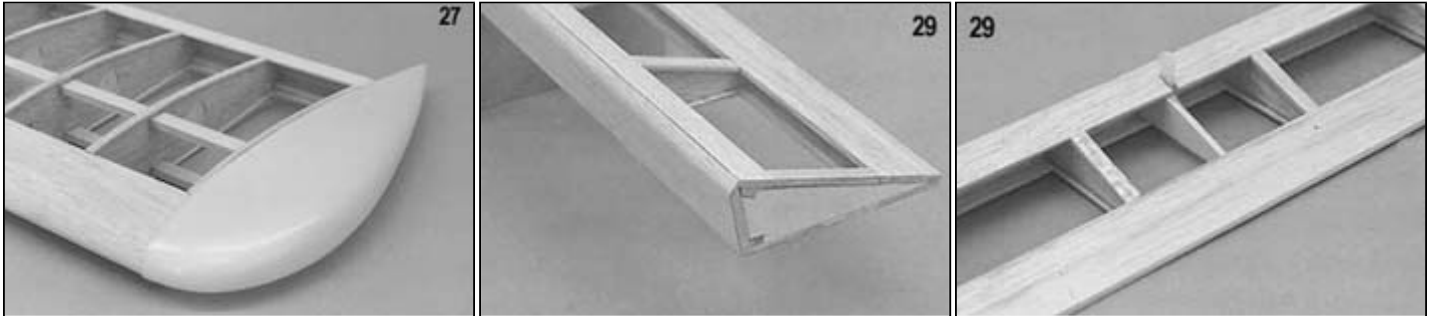

30. Cut hinge slots in the aileron leading edge and the wing cutout to accommodate the nylon hinges. Use four hinges per aileron, in the positions shown on the plans. Trial fit the hinges and aileron on the wing, without glue, to check for smooth operation and proper fit. If there is any mismatch or binding, alter the slots as necessary to correct. Notice that the aileron should be positioned on the wing so that it has equal gap, about 1/8" at each end. The gap at the leading edge should be 1/16" or smaller. The hinges should not be glued in place until after the wing and aileron have been covered.

AILERON CONTROL HORN POSITION

By placing the control horn aft of the hinge line, the aileron will automatically have differential movement, that is, it will hinge slightly further up than down. The further aft of the horn, the more "differential". On an airplane like the Spacewalker II, differential ailerons improve the quality of the turns in flight. We recommend that you use the horn position shown here.

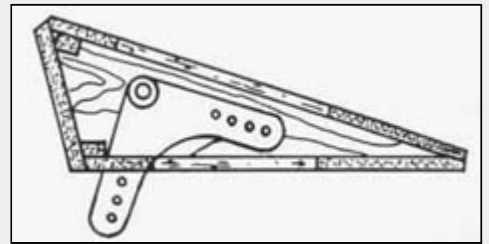

31. Repeat steps 4 through 30 for the other wing half.

Joining The Wing Halves

32.
 - a. Sand the inboard ends of the wing halves bringing the spar leading edges, and the trailing edges flush with the end ribs. Trial fit the two halves together with the die-cut 5/32" plywood BD-1 and DB-2 dihedral braces. The center ribs should meet flush when the dihedral braces are clamped in place temporarily. The long dihedral braces will automatically set the proper dihedral.
 - b. Use slow-drying epoxy glue to join the halves. DB-1 and DB-2 together. Hold everything in place with clamps until dry. Try for good joints and don't be stingy with the glue during this step! Before it dries, double check that the two halves are aligned perfectly with each other.

33.
 - a. Add the 3/32"x1/8" balsa spacers to the top spar notches on the four W-1 wing ribs. When dry, sand the spacers even with the tops of the ribs.
 - b. Install the top center sheeting using pieces cut from the 3/32"x3" balsa sheet provided. Don't sheet the bottom yet.
 - c. Make small cutouts in the top center sheeting to pass the wires through.



Refer now to the Fuselage Instructions, step 67, before proceeding.

Several steps in the fuselage instructions actually involve work on the wing. Fuselage construction must be completed through step 73 before continuing in this section.

- 34.
- Trim the two center W-1 ribs for the rear landing gear blocks, using the W-1A ribs as guides.
 - Fit the basswood rear landing gear blocks to the wing by beveling the ends to match at the center where they meet. Glue the blocks in place.
 - Reinforce each rear l.g. block with short lengths of 1/2" balsa triangle stock glued to the top of the blocks and SW-1.
 - Add the die-cut 3/32"x1/2"x3-3/8" plywood l.g. mount plate to the wing. These plates provide a solid base for the nylon l.g. straps, and should be flush with the surface of the rear l.g. blocks. See the "WING RIB CROSS SECTION at W-1" for more clarity on their position.



- 35.
- Carefully trim the wing leading edge flush with the support blocks to make a seat for the front landing gear block.
 - Cut away the exposed portion of the two center W-1 ribs so that they are even with the front notches in the W-1A sub-ribs.
 - Trim the front landing gear blocks so that their inner ends meet at the center with the proper dihedral angle and the outer ends are flush with the W-1A sub-ribs. The l.g. blocks must sit firmly in the W-1A front notches and should also sit flat against the support blocks and leading edge. Epoxy the blocks in place, being sure to use plenty of glue.
- 36.
- Cut out the bottom center sheeting that fits between the front l.g. blocks and the rear l.g. blocks out of 3/32"x3" balsa provided. Glue it in place.
 - Add the 3/32" balsa center sheeting to the bottom of the wing from the main spar back to the trailing edge.
 - Glue scraps of 3/32" balsa to the sides of W-1A sub-ribs to finish off the bottom center sheeting.
37. Cut two 14" strips from the two inch wide fiberglass tape material provided. Apply the strips to the top and bottom of the wing center joint using slow drying epoxy. You should cut the bottom strip into two pieces to avoid the slots for the landing gear wires.

To apply the strips:

- Coat the wing center with slow-drying epoxy.
- Lay the fiberglass strip on the top of the glue.
- Holding one end of the strip so it won't move, "squeegee" the glue through the tape with a small paddle to smooth the tape and remove the excess glue.
- When dry, sand lightly to remove any rough spots, being careful not to sand into the fiberglass tape itself.



TAIL ASSEMBLY

Before beginning construction on the tail surfaces, carefully cut out all of the "S", "E", and "R" parts from the 5/16" printed balsa sheet. A jig saw works best for cutting these out. Cut just outside the lines, leaving all of the lines on the parts. When fitting the parts in the structure, use a sanding block to bring the edges to an exact fit. Pin the plans to the building board and cover them with waxed paper.

Stabilizer and Elevator

- 38.
- Pin the 5/16"x1/2" balsa stabilizer trailing edge in place over the plans.
 - Cut the stabilizer leading edges from a piece of 5/16"x1/2"x30" balsa. Pin the leading edges in place and glue them together at the center.
 - Glue in the 5/16" balsa S-1, S-2, and S-3 center sheeting parts.
 - Add the 5/16" sq. balsa ribs and end pieces.
 - Glue in the 1/8"x5/16" balsa diagonal ribs.

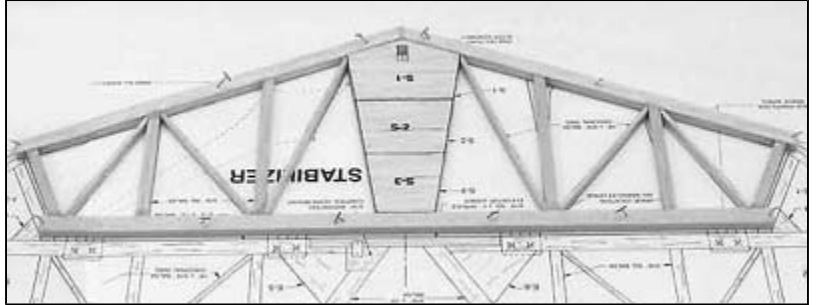

- 39.
- When dry, remove the stabilizer from the building board and lightly sand the top and bottom to smooth out the glue joints. Use a sanding block to sand all edges round. You may find that a line drawn along the center of all frame pieces can help in getting a consistently rounded edge.
 - Trim off the leading edge point as shown on the plans.

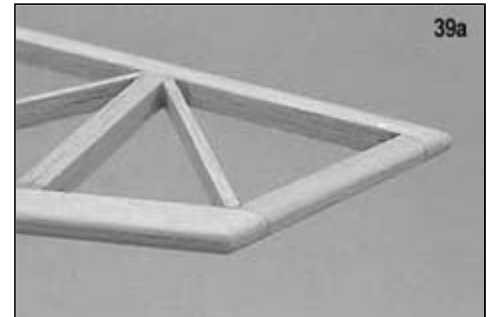

- 40.
- Pin the 5/16" sq. x 5" spruce elevator joiner in place on the plans.
 - Cut the elevator leading edges from 5/16"x1/2" balsa, being sure to notch for the elevator joiner. Glue the elevator leading edges to the elevator joiner and pin them in place.
 - Add the pre-cut 5/16" basswood control horn mount.
 - Cut out the elevator tips and trailing edge pieces from 5/16"x1/2" balsa and pin them in place. These parts will be trimmed to shape later.
 - Glue in all of the "E" parts, E-1 through E-6.
 - Add the 5/16" sq. balsa ribs and end pieces.
 - Add the 1/8"x5/16" balsa diagonal ribs.

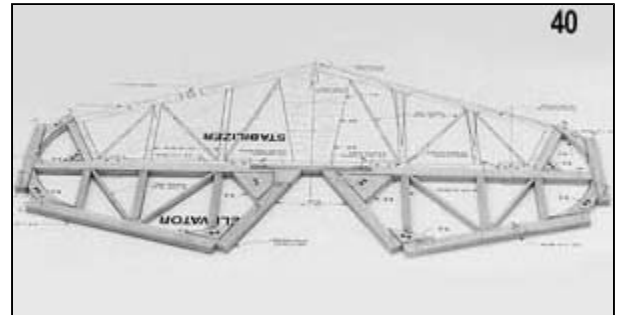

- 41.
- When dry, remove the elevator from the board and trim it to the correct outline. An easy way to do this is to make a tracing of one elevator half and cut it out. Place the tracing over the elevator, draw around the outline, then sand it down to the line. Repeat for the other half. Lightly sand the top and bottom, and round all the edges as you did with the stabilizer.



- 42.
- Make the hinge slots in the stabilizer and elevator in the positions shown on the plans.

Fin and Rudder

- 43.
- Pin the 5/16"x1/2" balsa fin trailing edge in place. Notice that the trailing edge extends to the bottom of the fuselage.
 - Pin the 5/16"x1/2" balsa fin leading edge in place. Notice that the leading edge extends down below the stabilizer.
 - Glue the 5/16" sq. balsa ribs in place.
 - Add the 1/8"x5/16" balsa diagonal ribs.
 - When dry, remove the fin from the board and sand the leading edge, top edge, and trailing edge round. Leave the bottom 5/16" sq. balsa rib unsanded so that it can sit flat against the stabilizer.

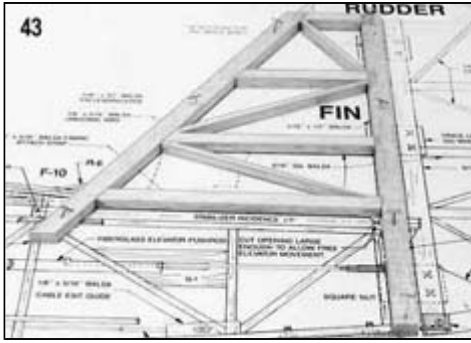

- 44.
- Pin the 5/16"x1/2" balsa rudder leading edge to the plan.
 - Glue R-1 through R-5 in place.
 - Add the 5/16" sq. balsa ribs and 1/8"x5/16" balsa diagonal ribs.
 - When dry, unpin the rudder and sand all of the edges round.

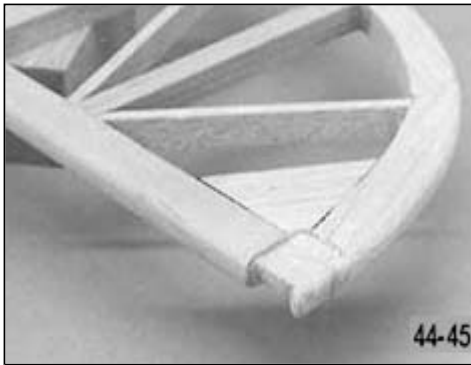

HINGING TIPS

When assembling each hinge, leave about a 1/16" gap between the head of the pin and the edge of the hinge when you make the bend. After the bend is made and the pin point is clipped, push the pin head up against the side of the hinge. This will move the bend away from the hinge, preventing it from causing a "bind".

Once you have cut the initial slot in the wood with a knife and widened it slightly with a small saw blade, a thicker saber saw blade can be used to help widen the slot to the proper thickness for the heavy-duty hinges.

Apply a drop of oil or a bit of vaseline to the center "bulge" of the hinges. This will prevent any glue from bonding at the critical hinge joint. Be sure to keep the flat part of the hinges free of oil.

A good way to insure that the hinges are soundly glued to the structure is to apply Sig slow-drying epoxy to each hinge slot using a Sig Mini Glue Gun (SH-627). Smear a layer of epoxy on both sides of the hinges and push them into the slots. Wipe away any excess glue before it dries.

Work with only one control surface at a time. For example, glue the hinges to the stabilizer, allow them to dry, then glue the elevator to the hinges.

NOTE: Many modelers feel that it is easier to cover the horizontal tail surfaces before they are hinged. If you elect to do this, first test assemble the tail surfaces on their hinges without glue, to insure that a good match between the elevator and stabilizer was obtained during the sanding process. Notice that the tips of the stabilizer leading edge must be trimmed slightly to blend in with the curve of the elevator tips.

45. Carefully carve a relief in the bottom of the rudder to accept the rudder horn. Epoxy the horn in place, then drill through the horn and rudder with a 3/32" drill bit. Install a 2-56 x 1/2" screw and 2-56 hex nut to anchor the horn to the structure.
46. Make the Fin and Rudder hinge slots in positions shown on the plan.

Attaching The Tail Brace Wires

The tail brace wires are a scale feature that will add tremendous strength and rigidity to the entire tail assembly on your model. We recommend that you install all of the wires. The photo shows a typical installation. See the "Tail Brace Wire Assembly" drawing on Plate 3 of the plans for more information.

Using the plans as a guide, carefully mark the position of each brace wire attach tab on the tail surfaces and fuselage bottom. Drill at the marks with a 3/32" drill bit. and then fasten in place with a 2-56 x 1/2" screw and 2-56 nut. Apply some Lock-Tite or glue to the nuts to avoid any possibility of them loosening due to engine vibration.



Pre-bend the steel tabs to their approximate angle, then drill the holes in the TWM with a 1/16" drill bit and fasten them in place using the hardware described on the plan. NOTE: The 1/2" long aluminum tubes should be cut in half, making two 1/4" long tubes to clamp the wires.

Steel cable is provided in the kit to serve as tail brace wires. Cut each wire about two or three inches longer than necessary so you have some excess to work with, (Remember to save some of this cable for the rudder control system.) Fasten the wires as described on the plans. What you want are eight wires, each with a slight amount of tension. The actual amount of tension is not too important as long as they are all about the same and the tail surfaces aren't twisted or distorted from their normal position.

FUSELAGE CONSTRUCTION

Before beginning work on the fuselage, you should decide what engine you plan to install. The firewall position shown on the plan will work for most of the engines that can be used in the model. However, if the engine you have chosen is significantly longer or shorter than the one shown on the plans, you should consider moving the firewall position fore or aft to compensate. If you must build the model before deciding on an engine it would be better to build the nose too short than too long. That way a plywood shim or mounting "box" can be added to the front of the firewall if necessary to position the engine correctly.

Pin both the front and aft fuselage main frame drawings to the building board and cover with wax paper.

Before beginning work on the fuselage, carefully cut out the WS-1, WS-2, WS-3, and WS-4 wing saddle pieces from the 3/16" printed balsa sheet (Sheet #9). As with the printed tail parts, cut just outside the lines with a jig saw or modelling knife. Use a sanding block to fit the parts exactly to the structure.

47.
 - a. Begin construction of the front fuselage main frame by gluing and pinning down the 3/16" sq. spruce pieces along the top, front, and bottom.
 - b. Pin and glue the WS-1 and WS-2 pieces in place.
 - c. Glue in the 3/8" sq. balsa uprights.

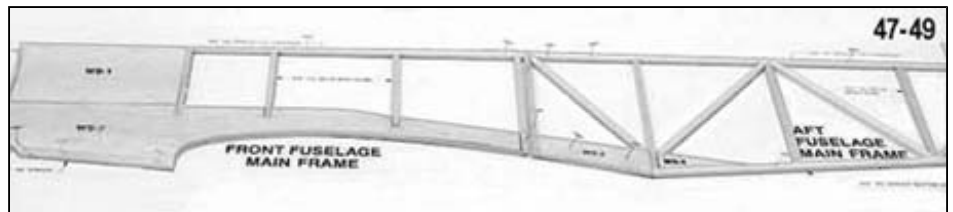

48. Build the second front fuselage main frame exactly as the first. When dry, pin the frames together and lightly even up the edges with a sanding block. Sand both sides of each frame to remove any rough spots or glue "bumps".

49. Repeat the process to construct two aft fuselage main frames.

50.
 - a. Glue the die-cut lite-ply PS-1 pieces to the front fuselage main frames. Be sure to make one right and one left side.
 - b. Glue the PS-2 pieces to the aft fuselage main frames, again being certain to make a left and a right.

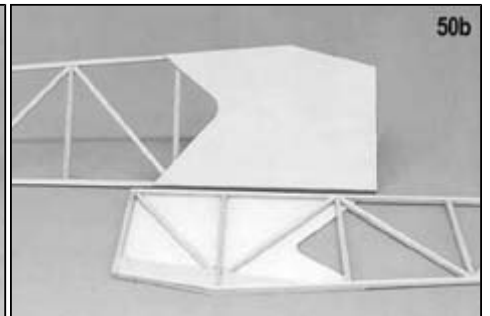
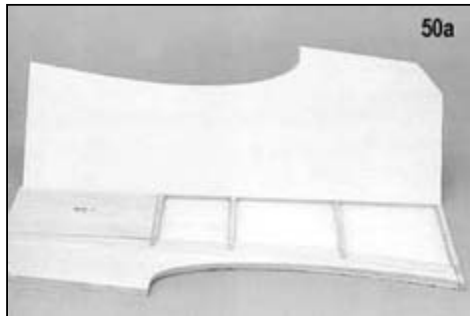

51.
 - a. Pin the front fuselage main frames upside-down over the fuselage top view (Plate 1). The plywood side pieces (PS-1) should be facing inward. Make certain the sides are vertical and use temporary braces (marked with a "T" in the photo) to hold them in position.
 - b. Carefully cut and fit the 3/16" sq. balsa crossbraces and glue them in place. There are six crossbraces on the top of the fuselage (next to the plan) and four on the bottom. Notice that the crossbrace at the front of the wing (marked with an "X" in the photo) should be positioned 3/32" forward of the wing leading edge to make room for the PW plywood pieces to be installed later. Check the squareness of the fuselage several times during this step. When dry, remove the temporary braces.

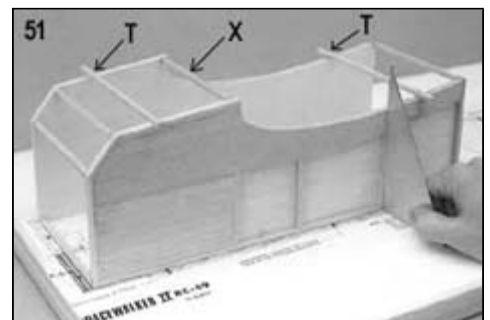

52.
 - a. Taper the ends of the aft fuselage main frames where they join at the rear.
 - b. Pin the aft fuselage main frames upside-down, plywood side pieces facing inwards, on the fuselage top view (plate 1), and glue them together at the rear. Use a triangle and temporary braces to hold the frames square as you did with the front fuselage main frame.
 - c. Glue the 3/16" sq. balsa crossbraces between the frames, (seven on the top, seven on the bottom). NOTE: Since the stabilizer has a +1 deg. incidence the stab area of the aft main frame will not sit flat on the building board, it will be raised slightly when pinned upside-down.



53. Sand the front end of the aft fuselage section with a large sanding block so that it fits flat against the front fuselage section. Check the alignment of the two fuselage sections over the top view drawing. When satisfied with the fit, epoxy the aft section to the front fuselage section and allow to dry.

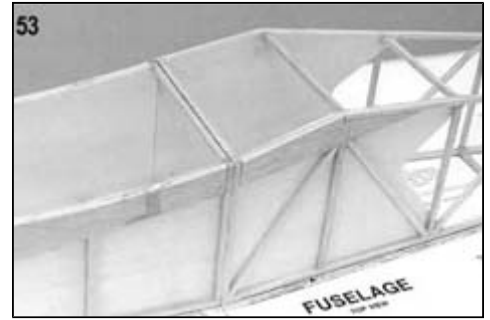

- 54.
- Glue the die-cut lite-ply part PT-1 to the top of the fuselage.
 - Glue PB-1 to the fuselage bottom with the rear edge even with the front edge of the balsa crossbrace. Trim off the excess at the front so that it is flush with the front face of the fuselage. Sand the rear edge of PB-1 at the same angle as the fuselage bottom.

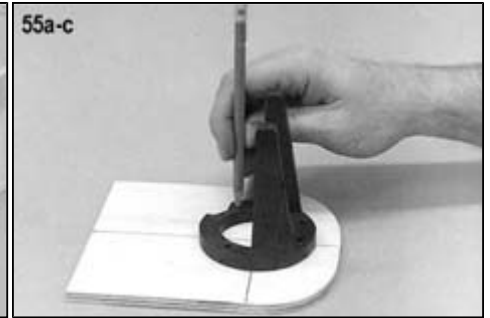
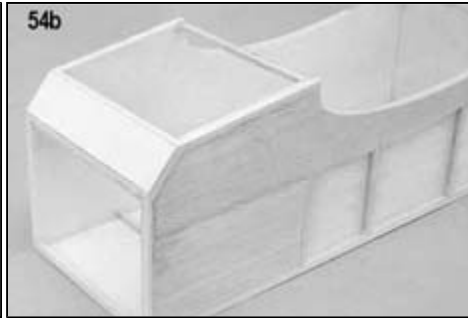

- 55.
- Construct the firewall by gluing the two 5/32" plywood F-1 formers together with Sig Kwik-Set Epoxy. Use a heavy weight to hold the two pieces perfectly flat while drying.
 - When dry, use the "Cross Section at F-1" drawing (Plate 1) to draw the vertical centerline and the thrust line on the firewall.
 - Carefully position your engine mount on the firewall and mark the location of the mounting bolts. Drill the firewall with a 15/64" drill bit at the marks and install your blind nuts and glue them firmly in place.
 - Use the screws that came with your engine mount to fasten your engine in place. The engine should be carefully positioned so that the distance from the firewall to the rear face of the spinner backplate is exactly 5-13/16".

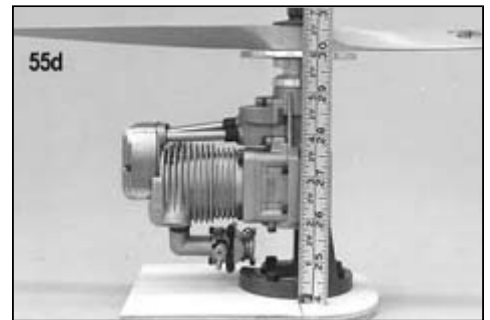

- 56.
- Epoxy the firewall in place on the fuselage. The thrust line should be level with the top of the spruce longerons and balsa crossbrace. **NOT THE TOP OF PT-1!**
 - Reinforce the firewall/fuselage joint with the lengths of 3/4" triangle stock, one on each side.
 - Carve and sand the bottom edge of the firewall at the same angle as PB-1



- 57.
- Glue the die-cut lite-ply F-6 former and the die-cut balsa F-6A former together.
 - Glue the two die-cut balsa F-5 formers together.
 - When dry, glue the F-5 and F-6 assemblies to PT-1 in the position shown on the plan. Use a triangle to make sure they are square with PT-1.

- 58.
- Glue the die-cut balsa formers F-2, F-3, and F-4 to the top of the fuselage in the position shown on the plans.
 - Glue F-1A to the back of the firewall.

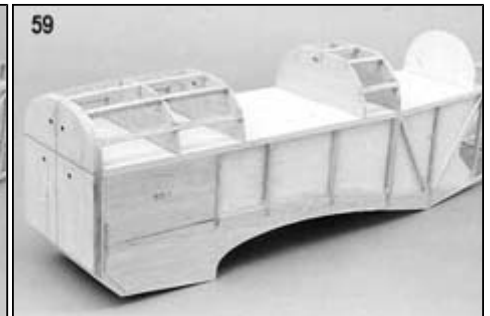

- 59.
- Glue five 1/4" sq. balsa stringers between formers F-1A and F-3. Trim the stringers flush with the back edge of F-3.
 - Add the 1/4" sq. balsa stringers between F-4 and F-5.

60. Cut out the top deck sheeting using the patterns provided.

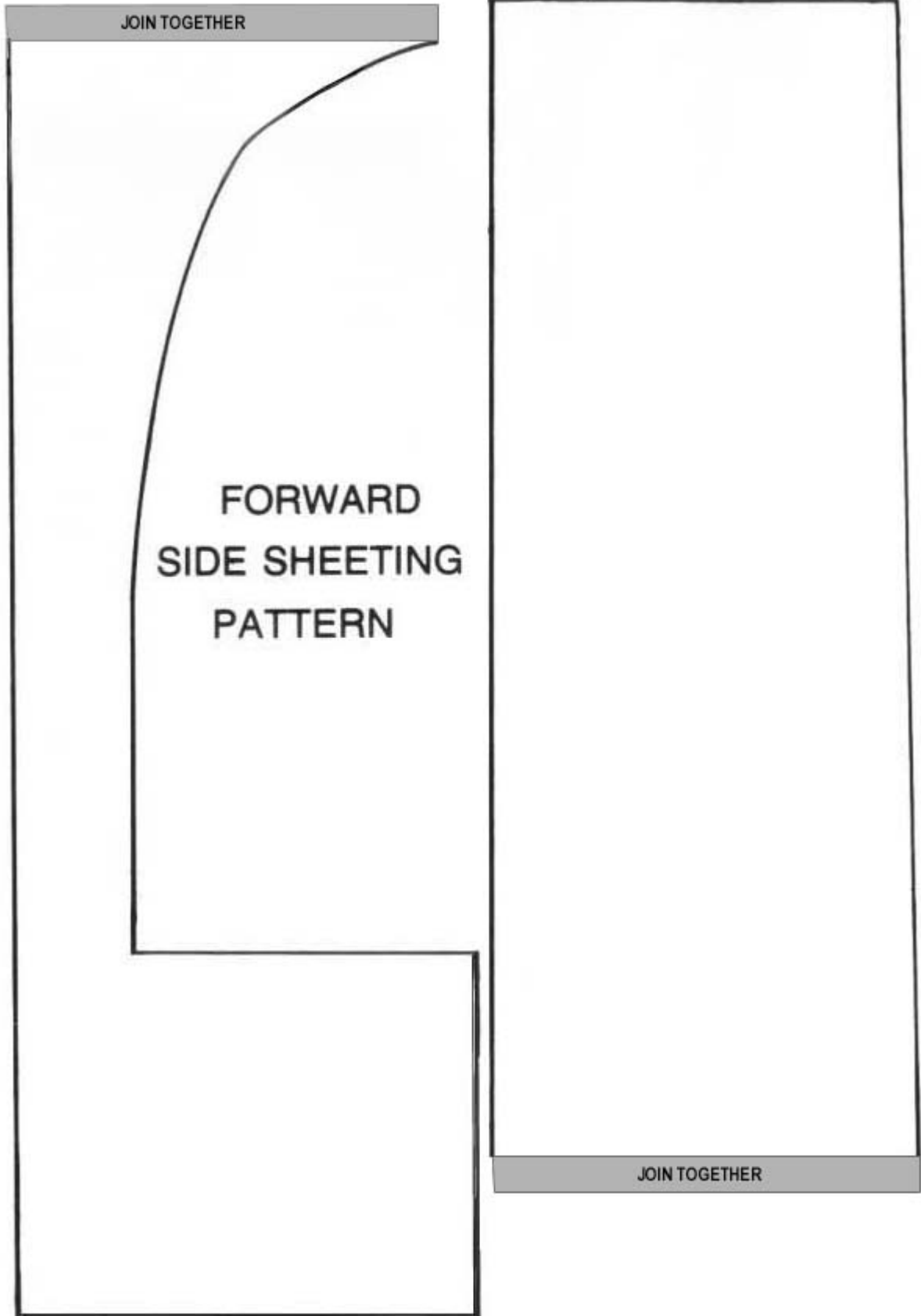

61. a. Begin sheeting the top deck with the two forward side pieces. The bottom edge of the forward side piece should overlap the edge of PT-1, even with the top edge of the top longeron. The rear edge of the sheet should overlap the front F-5 former leaving the rear F-5 former exposed. The front edge of this sheet is extra long so that it can be trimmed later. It may be necessary to soak the outer surface of the balsa with water or alcohol to help it bend around the formers. While wet, gently form the balsa with your fingers to about the right contour, then glue it in place starting with the bottom edge.
- b. Once the forward side pieces are attached, the forward center piece can be trimmed for a perfect fit. Glue in the forward center piece. Easy-to-sand Sig-Bond is recommended for gluing all of the sheeting edge joints.
62. a. Finish the top deck sheeting by gluing on the rear side pieces and the rear center piece in the same manner as the front pieces. You may have to trim the length of the side piece to end at the rear face of F-6.
- b. When dry, trim the excess top deck sheeting even with F-1 and F-4.

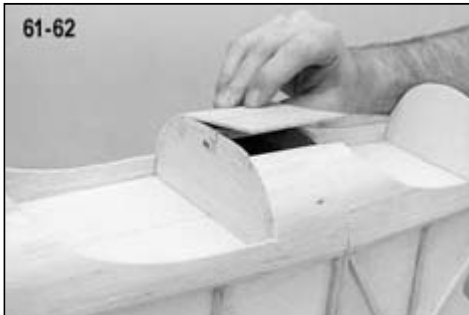
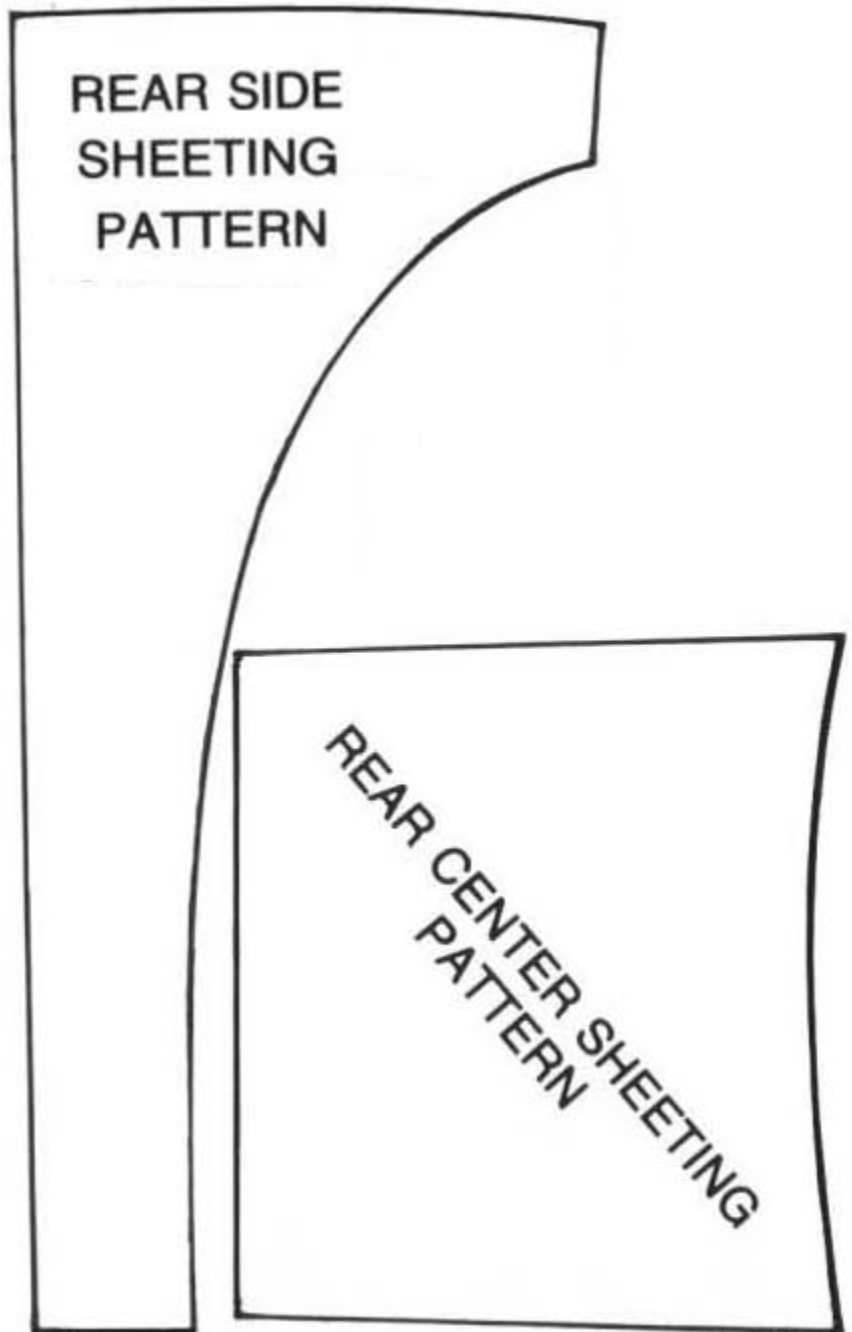

63. Position the lite-ply formers F-7 through F-10 over their respective cross sectional drawings on the plans. Mark the positions of the top stringers on the formers. Then glue F-7 through F-10 in their correct position as shown on the plans.

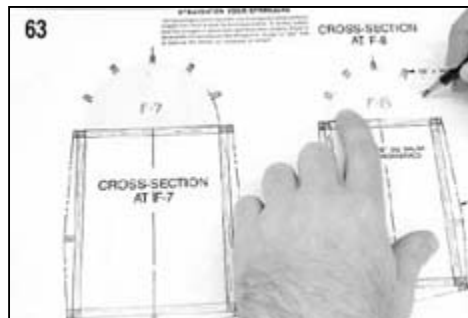

64. Cut and glue the five 1/8"x1/4"x36" balsa top stringers to the formers F-6 through F-10. The center stringer should be left extra long at the rear so that it can be trimmed to match the fin later. The two stringers on either side of the center stringer should be rounded at the rear as shown on the plans. The two outboard stringers are cut off flush with F-10. All of the stringers should be perfectly straight from front to rear. Strengthen each stringer-to-former joint with a small fillet of glue.

65. Add the die-cut balsa apron pieces between the stringers. The apron pieces will need to be trimmed on each side for a perfect fit.

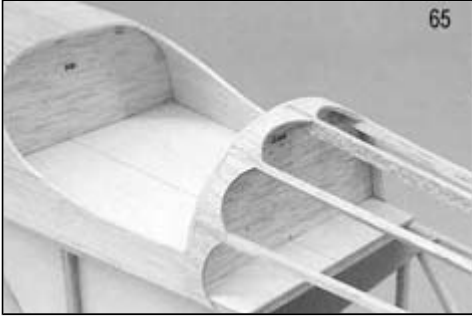

- 66.
- Glue the two die-cut Lite-Ply PF pieces to the sides of the fuselage as shown on the plan.
 - Glue the 1/8"x3/16" balsa fill strips to the sides of the aft top and bottom longerons.
 - Glue the 1/8"x3/16" balsa fill strips to the bottom of the bottom longerons. Note: Check the cross-section drawings on plate 1 of the plans for the correct placement of these fill strips and make sure you leave room for the tail wheel mount (TWM) that will be installed later.
 - The 1/8"x3/16" balsa fill strips should now be glued to the side of the top longerons on the front fuselage section.
 - Add the 1/8"x3/16" balsa fill strips to the side of the fuselage just forward of the wing leading edge..
 - Glue the die-cut balsa FS-1 pieces to the fuselage sides.
 - Add the 1/8"x3/16" balsa fill strips to the aft fuselage wing saddle.

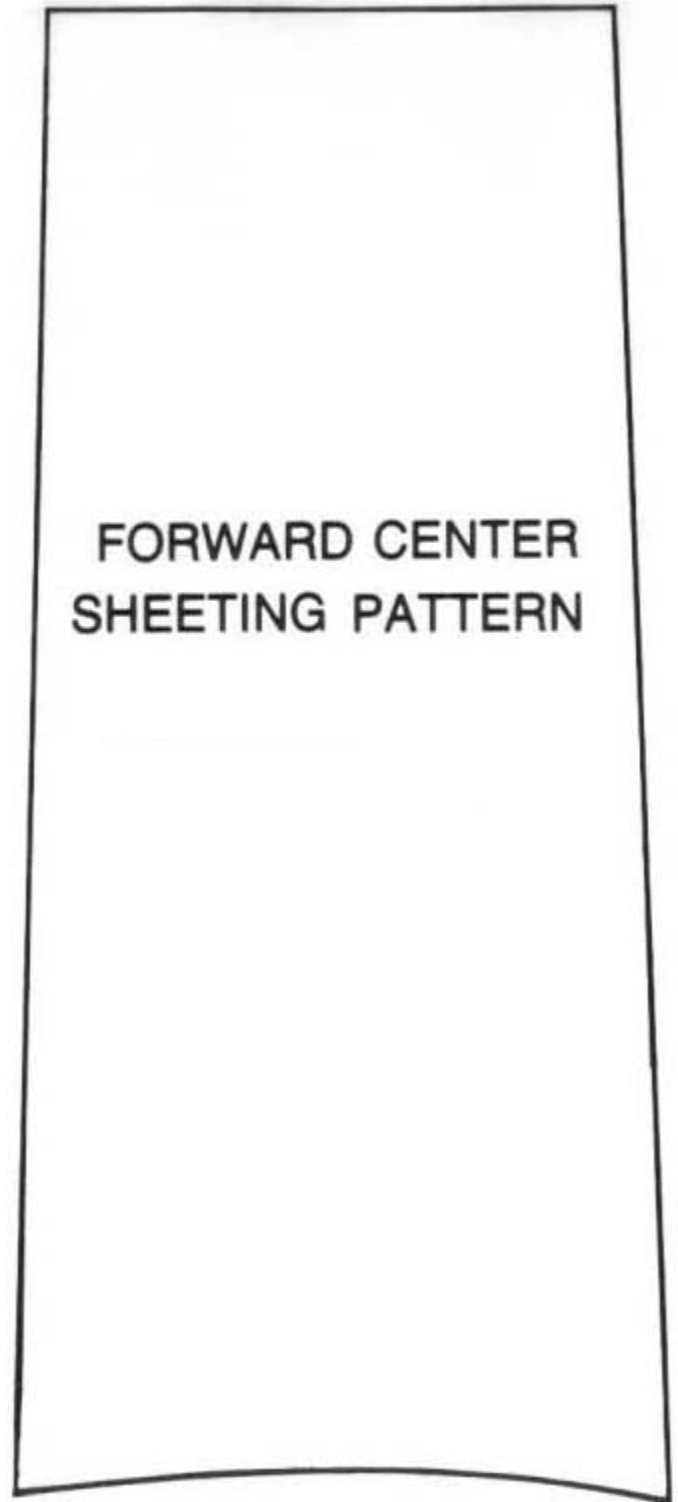
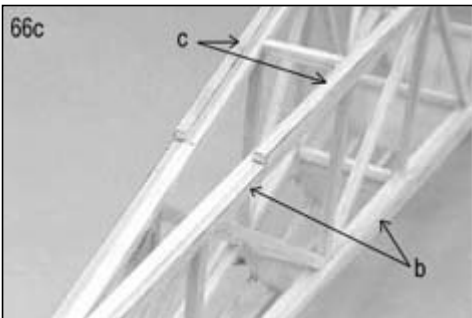

Fitting The Wing To The Fuselage

67. NOTE: The wing, completed thru Step 33 is needed for the following steps. The wing saddle area must be carved at an angle for the wing to seat properly on the fuselage. Use the Lite-Ply side pieces PS-1 and PS-2 to act as a guide which should not be altered. Sand the balsa until you reach the edge of the ply, then stop. Use the die-cut Lite-Ply Wing Saddle Carving Guide to check your progress as you work. If you should overcarve, do not fix it by trying to reshape the bottom (which could cause a change in the wing incidence.) Instead, fill in the gap with model putty. Lay the wing on the saddle and check the fit.

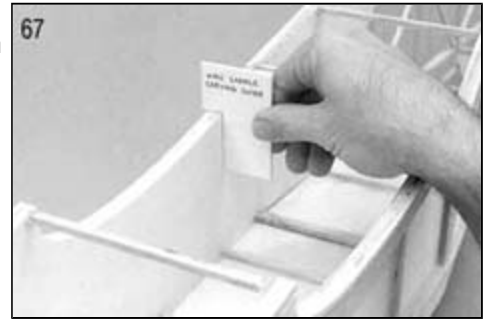

- 68.
- The remaining W-1A sub-ribs are positioned in the wing so that they line up with the fuselage sides. With the wing positioned accurately on the fuselage, lay a straightedge along the fill strip on the fuselage side so that it extends over the wing. Now mark the bottom leading edge sheeting with a soft lead pencil.
 - Remove the wing from the fuselage and carefully cut away the bottom leading edge sheeting at the line. Don't cut the spar!
 - Trial fit the W-1A sub-ribs and trim as necessary. Glue the sub-ribs into the center section so that they rest against the cut edge of the leading edge.

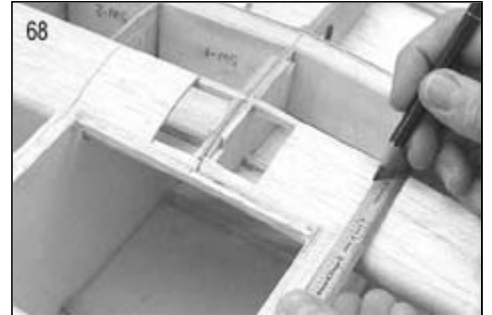

69. Two pieces of 1/2"x2-3/4"x7/8" balsa are provided for landing gear support blocks. These are installed against the back of the leading edge, with the grain running vertically. Notice that the top of the support blocks must be sanded to the contour of the top leading edge sheeting. The bottom of the blocks should be flush with the cutouts on the W-1A sub-ribs. When satisfied with the fit, firmly glue the blocks in place.

- 70.
- Glue the die-cut 3/32" plywood PW wing hold-down straps to the inside of the fuselage. The top end of the PW sits against the rear edge of the 3/16" sq. balsa crossbrace.
 - Brace the front side of PW to PS-1 with 3/4" triangular stock.

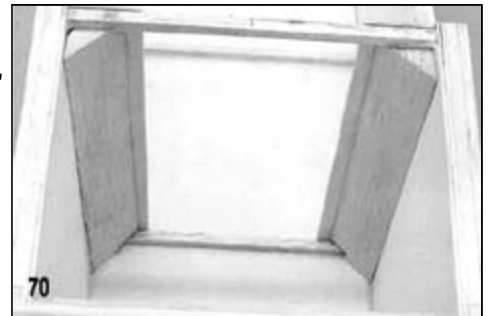

- 71.
- Use the "Cross-Section at F-3" drawing (Plate 1) to locate and mark the position of the wing hold-down dowels on the PW pieces.
 - Drill the PWs at the marks with a 7/32" pilot drill, then follow with a 1/4" drill.

- 72.
- Sharpen one end of the 1/4" dia. x 1-1/4" long wing hold-down dowels, being sure to keep the point centered. Push the dowels into the PW pieces from the front so that just the points stick out the backside.
 - Carefully slide the wing into position, pushing the sharp dowel points into the wing leading edge.
 - Remove the wing and drill two 1/4" dia. holes through the wing leading edge at the punch marks.



- 73.
- Remove the dowels from the PW wing hold-down straps. Reinsert the dowels from the other side through pieces of waxed paper. Only push dowels in 1/4" to 5/16" - leave most of the dowel length sticking out.
 - Trial fit the wing in position, sliding it onto the dowels. Check to see that the wing still fits the fuselage. If not, slowly enlarge the hole and the wing leading edge until it fits properly. When satisfied with the fit, glue the inside of the holes with epoxy and slide it back in place on the fuselage. When dry, carefully remove the wing and fill in any small gaps around the dowels at the wing leading edge with another application of glue. (Again refer to Photo 34-35 to see the end result of this step.)

- 74.
- The 3/4"x3/4"x1-1/2" basswood wing mounting blocks must be beveled on the side so that they fit flat against the fuselage side (PS-2) and the top surfaces of the wing. Check their fit by installing the wing onto the fuselage and holding the block in place. When they fit properly, epoxy the wing mounting blocks in place.
 - Glue 3/4" triangle stock to the top of the wing mounting block.

75.
 - a. Tape or pin the wing to the fuselage, making sure that it is in perfect alignment. Accurately mark the position of the wing hold-down bolts on the bottom surface of the wing. Visually confirm that a hole drilled at the mark will pass through the approximate center of the wing hold-down blocks.
 - b. Drill thru the wing and the wing hold-down blocks at the same time with a #7 (or 13/64") drill bit. Keep the drill perpendicular to the bottom face of the wing so the nylon bolt heads will seat flush.
 - c. Remove the wing and tap the wing mounting blocks with a tap. Apply a few drops of thin CA to the holes to strengthen them. When dry run the tap back through the threads.
 - d. Redrill the holes in the wing with a 1/4" drill bit.



Completing The Fuselage

76.
 - a. Cut and shape the bottom stringer from a piece of 1/8"x5/16"x36" balsa. Bolt the wing to the fuselage, then glue the bottom stringer in place, lining it up with the center of the wing.
 - b. Trim the two 5/16"x1"x2-5/8" balsa trailing edge supports to fit between the bottom stringer and the balsa fill strips, just behind the trailing edge of the wing. When satisfied with the fit, glue them in place, then carve and sand them to blend into the wing.



77.
 - a. Mark the positions of the side stringers on the fuselage main frame. Cut and shape the side stringers from 1/8"x1/4" balsa, then glue them in place on the fuselage.
 - b. Use a sanding block with one end covered with heavy paper to sand the fill strips to the shape shown on the cross-sections. The paper protects the balsa stringers from being taken down while sanding the fill strips. Use the same technique to sand the fill strips on the front fuselage section, including FS-1. Complete the shaping by sanding the corners round on the fuselage bottom.

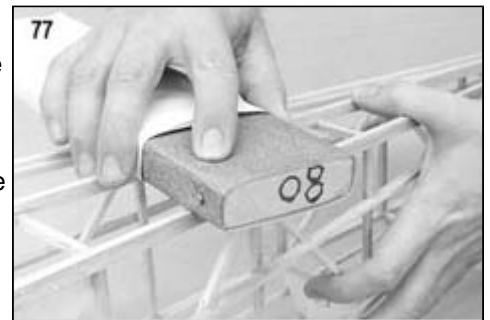

BUILDERS'S TIP

While there is still easy access through the bottom, now is the time to install the fuel tank, throttle pushrod etc. (See "Throttle Hookup" further down.) The fuel tank should be mounted with its centerline even with or slightly below the centerline of the engine's carburetor. Materials for mounting the tank are not furnished especially, but there should be plenty of scrap that can be used. The tank supports should hold the tank in it's proper position but should also allow it to be pulled out easily if necessary.

TIPS ON TANKS

The 16 oz. fuel tank shown on the plans will provide sufficient run time for most of the engines that are suitable for the Spacewalker II, although there is plenty of room for a larger tank if desired. The plans show a DuBro tank, but other styles may be used as well.

The simplest tank set-up to use in the Spacewalker II is normal suction feed with two vents, as shown in the diagram below. One vent tube should go to the top of the inside of the tank, and the other vent tube should go to the bottom of the tank. The clunk line on the fuel feed tube must swing freely without hitting the back of the tank. Remember to use a fuel tank stopper and fuel lines that are compatible with the type of fuel to be used.

For best results, the fuel tank should be positioned so that its centerline is even with, to 1/4" below, the needle valve on the engine. It can be mounted with scrap balsa supports to hold it in place. Should the need ever arise to remove the tank for servicing, simply break away the balsa supports. You can seal around the hole in the firewall where the fuel lines come through with silicone rubber sealer to prevent exhaust oil from leaking inside the fuselage.

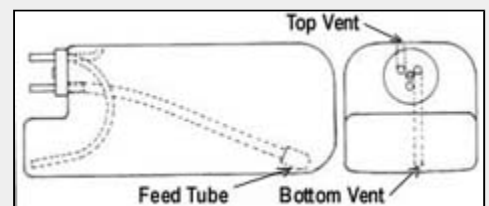

Run fuel tubing from the fuel feed line to the carburetor. Two more lengths of tubing run from the vent tubes to the bottom opening in the cowl. To fuel or defuel the aircraft use the vent line that goes to the bottom of the tank and plug this vent with a short bolt to keep the fuel from siphoning out.

If your engine's muffler is equipped with a pressure tap, you can make use of it to help provide a more reliable fuel feed. To do this, connect the top vent line with a pressure tap. The other vent line must still be plugged with a bolt to operate properly. To refuel, remove the vent line from the pressure tap and remove the bolt from the other line, then fill the tank as you normally would.

NOTE: The wing, completed thru step 35 is required for the following step.

78.
 - a. Glue together the two 3/8"x3"x4-3/4" balsa bottom sheets to form a piece that is 6"x4-3/4".
 - b. With the wing bolted to the fuselage, use a sanding block to bevel the back edge of the bottom sheet so that it sits flush against the landing gear mount in the wing leading edge. When satisfied with the fit, glue the bottom sheet to the fuselage.
 - c. When dry, sand the bottom sheet to the contours shown in the "Cross Section at F-1, and F-3" drawings (Plate 1). The bottom sheeting should now blend smoothly into the landing gear mount.

79.
 - a. Cut a slot in the die-cut Lit-Ply G-1 as shown on the plan and glue it to the left side of the fuselage as shown on the plan. The outer edge of G-1 should be flush with the outer edge of the fuselage main frame.
 - b. Glue scrap pieces of 1/8"x5/16"x1-1/2" balsa in place on each fuselage side to serve as cable exit guides.
 - c. When dry, drill the cable exit guides with a 9/64" drill to accept the nylon tubing guides. The holes should be drilled at a shallow angle so that the rudder cables will exit the sides of the fuselage in the direction of their attach point on the rudder control horn. Cut 2" lengths of nylon tubing from the piece provided in the kit and glue them into each of the holes. Cut the tubes off flush with the cable exit guides.

BUILDERS'S TIP

The task of drilling the holes for the rudder cable guide tubes at the shallow angle can be made easier, as follows. Use a small drill bit (1/16" dia.) or a shaped piece of music wire to first make a pilot hole. The 9/64" drill bit should then follow the pilot hole with know problem.

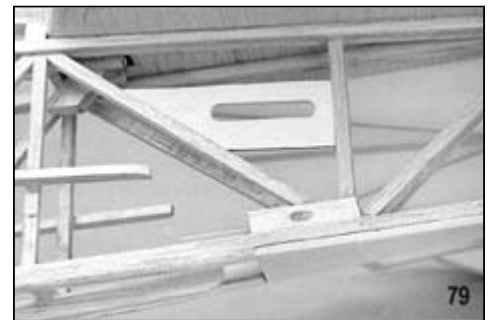

Attaching The Tail Surfaces And Tailwheel

NOTE: Many modelers prefer to cover their tail surfaces before attaching them to the fuselage. If you choose to do this, be certain that all the hinge slots are cut and the control surfaces move freely with the hinges temporarily in place.

80.
 - a. With the wing bolted in place, position the stabilizer on the fuselage and check its alignment carefully. Be certain it is square with the fuselage by viewing it from the top and rear. When you are satisfied with its position, make small marks on the fuselage and stabilizer so that it can be returned to the same position.
 - b. If you have already covered the stabilizer, the covering material will have to be cut away where the stab rests on the fuselage, so that you will have a strong wood-to-wood glue joint. Epoxy the stabilizer to the fuselage, lining up the marks that you made earlier. Recheck the alignment of the stabilizer as the glue dries, making adjustments as necessary.

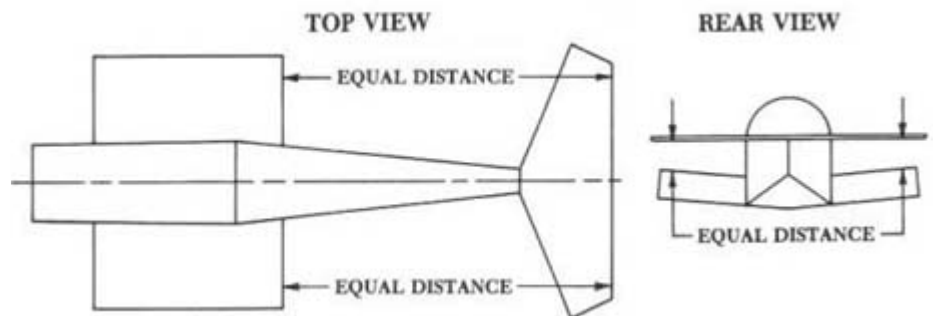

NOTE: The elevator must be permanently hinged to the stabilizer before the fin is attached.

81.
 - a. Trial fit the fin on top of the stab. You will have to trim the center top stringer to fit against the fin leading edge, and the fin trailing edge will need a small cut out to clear the elevator joiner. The extended tail post on the fin should be in good contact with the fuselage end. If the stabilizer has been covered, cut away the covering material where the fin attaches.
 - b. Epoxy the fin to the top of the stabilizer and the rear of the fuselage, using a triangle to make certain it is vertical. Also make sure that the fin is not offset to one side or the other by viewing it from above.

82.
 - a. Brace the bottom of the fin leading edge to the bottom of the stabilizer using small lengths of 3/16" sq. balsa. Refer to the "Cross-Section at Base of Fin Leading Edge" (Plate 3) for more information.
 - b. Install R-6 on the front of the fin. When dry, sand the edge round.
 - c. Add the 1/8"x5/16" balsa fabric attach strips to each side of the fin. Bevel the bottom edge of the fabric attach strips as shown in the "Cross-Section at Base of the Fin Leading Edge" (Plate 3) before gluing them in place. The top edge of the fabric attach strips may need to be trimmed at the front to blend in with the top stringers. The rear edge of the fabric attach strips should blend smoothly into the sides of the fin at the back.
 - d. Glue small scraps of 1/8"x5/16" balsa between the outermost top stringers and the balsa fill strips, just forward of the stabilizer leading edge. These scraps provide a place for the covering material to attach in the area.
 - e. Blend the fin post into the fuselage sides using scraps of balsa glued to each side of the fin. The balsa scraps should be sanded flush with the fill strips at the front and tapered down to nothing at the back edge of the fin post.

83.
 - a. Position the formed tailwheel leafspring on the die-cut Lite-Ply TWM tailwheel mount and mark the location of the mounting bolts. Drill TWM at the marks with a 5/32" drill bit. Mount the leafspring using the 6-32 x 3/8" machine screws and the square nuts provided.
 - b. Epoxy the nuts firmly in place being careful not to get any glue on the machine screws. When dry, remove the leafspring.
 - c. The spruce longerons have to be relieved slightly to allow room for the square nuts. TWM should now fit flat against the bottom of the fuselage and fin.
 - d. Epoxy TWM in place, being careful not to get any glue in the threads of the square nuts.

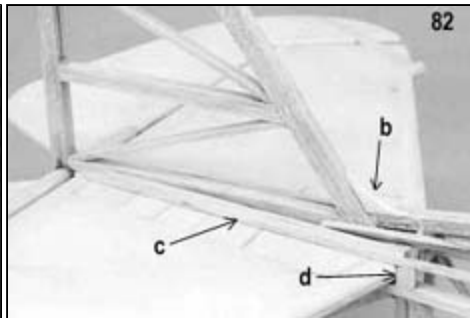
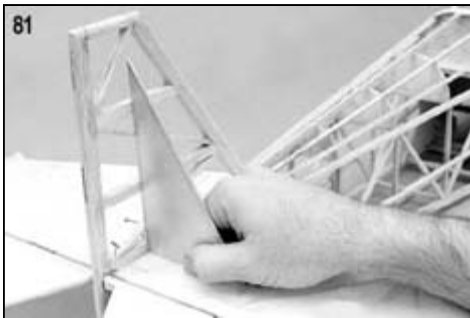

LANDING GEAR CONSTRUCTION

NOTE:

The completed wing is needed before the landing gear can be assembled.

84. Position the 3/16" front main landing gear wire and the 3/16" rear landing gear wire in the grooved landing gear mounts in the wing. The rear landing gear block will have to be notched on both sides to allow the rear wire to swing forward.

HELPFUL HINT:

Under the stress of a painfully hard landing, the 1/8" bottom shock strut wire will want very much to part company with the solder joints that bind it. Now, if those solder joints are flawless, the shock strut wire will surely be held fast. But, since very few of us are flawless, chances are good that our solder joints will be somewhat less than perfect. To help keep the ends of that shock strut wire firmly entrenched between the main l.g. wires, we suggest that you file or grind small notches into the shock strut wire as illustrated here. Now solder will flow into the notches and "lock" the shock strut in place, thus avoiding the unhappy possibility described earlier!

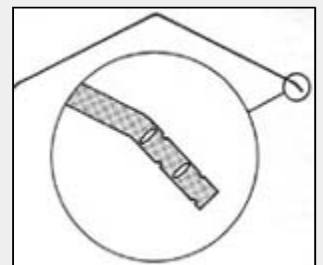

85. Hold the legs of the 3/16" main landing gear wires together and add the 1/8" bottom shock strut wire between them. Rebend the wires slightly. If necessary, to get all of the wires to line up properly, cyanoacrylate adhesive can be used to hold the wires temporarily. When you have them aligned, bind them tightly together with copper wire, then solder securely. Use plenty of heat and soldering paste so that the solder will flow completely around and through the binding. Drape a cloth over the wing to protect it from dripping solder or paste.

86. Remove the wire gear from the wing, then bind and solder the 1/8" dia. top shock strut wire in place. After all of the joints are cool, file and sand them to smooth out any prominent bulges in the bindings. Clean all joints with dope thinner or other suitable solvent.

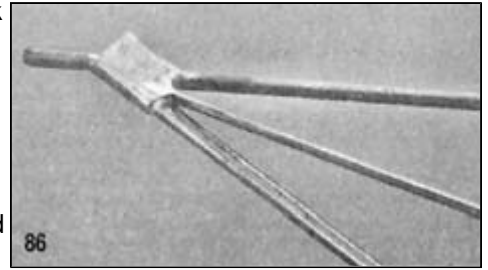

87. Cut a 1" long piece of scrap 1/16" dia. music wire (or similar) from leftover pieces you undoubtedly have in your workshop. Form it into a shallow "V"; then bind and solder it to the top shock strut wire. This serves as a hook for wrapping rubber bands around both shock strut wires to act as a shock absorber.

88. Refit the landing gear to the wing. Position the four large nylon landing gear straps over the wires as shown in the photo. Mark the hole locations for the straps, then pilot drill the landing gear mounts with a 3/32" drill bit and thread in the eight #4 x 1/2" sheet metal screws.

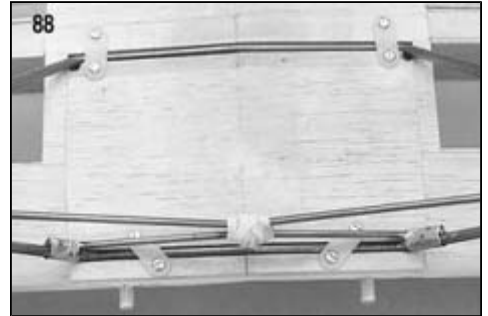

- 89.
- A single sheet of 3/16"x6"x4" balsa is provided for fairing in the side of the landing gear. Cut pieces to fit between the 3/16" wires, noting the grain direction shown on the plans. Epoxy the fairings in place and allow to dry.
 - Remove the landing gear assembly from the wing. Heavy-weight fiberglass cloth is provided for reinforcing the landing gear and fairings. Cover one side at a time using slow-drying epoxy to apply. Lap the cloth past the edges of the wood, completely around the 3/16" wires. When dry, sand smooth.

Fiberglass Cloth Cutting Diagram for landing gear fairings

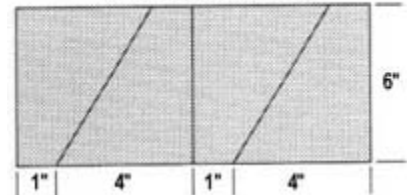

Wheel Pants

The directions given below are for a single wheel pant. Of course, you must make two wheel pant assemblies, a left and a right.

- 90.
- Clean and sand the inside of the wheel pant where the die-cut 1/16" plywood mounting plate will attach. Epoxy the plate in place as shown on the plans (Plate 1).
 - Carefully locate and mark the position of the axle on the wheel pant using the plans as a guide. Drill through the pant and mounting plate with a 3/16" drill bit.
 - Install a 6-32 x 3/8" socket head set screw into one of the molded nylon wheel pant mounts. Temporarily hold it on the outside of the pant and mark the location of the two outer holes. Drill through the pant at the marks with a 3/32" drill bit. Permanently fasten the wheel pant mount to the outside of the wheel pant with two #4 x 3/8" sheet metal screws.

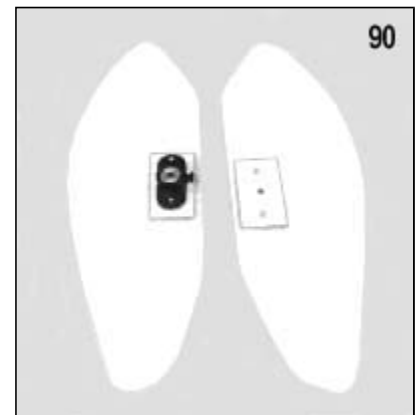

91. Use CA to glue the wheel pant halves together. When dry, cut the hole for the wheel into the bottom. The seam in the pants may be reinforced in the inside with fiberglass tape and thin CA glue.

92. You must grind or file a shallow flat spot on the wire landing gear where the wheel pant mount's set screw makes contact. The position of this flat spot will determine the position of the wheel pant. The flat spot may have to be slightly re-ground several times before the wheel pant assumes the correct angle. The centerline of the pant should generally be parallel with the fuselage longeron, and both pants should be parallel to each other.

COMPLETING THE MODEL

Cowling

- 93.
- CA adhesive can be used to assemble the cowl. Hold the plastic joiner in place on the inside of one cowl half. Leave half of the joiner strip extending over the edge so as to tap onto the other cowl half when it is attached. Flow a few drops of adhesive under the edge of the strip. It will spread along the seam by capillary action. Squeeze and hold together any area of the strip that is not down tight against the cowl. Be careful not to let the adhesive get under your finger. Let dry, then hold down the other half and glue it in the same manner. Let dry and even up the back of the cowl with a sanding block.
 - Use the full-size drawing for a pattern to mark out the openings in the cowl. Cut out the openings with a sharp knife or a Dremel tool with a drum sander attachment. Bring the cutouts right up to the lines using small sanding tools or a fine-tooth file. You will have to make small cutouts for the rocker arm covers if you are using a single cylinder engine.
 - Make a cutout in the front of the cowling for the engine's prop shaft. The cutout should leave plenty of clearance for the front end of the engine, but should be smaller than the 3" spinner diameter.

COWLING PATTERN

Cut out openings with a X-Acto knife and place over cowl to mark out holes. Use the 3" diameter hole and center line as a guide.

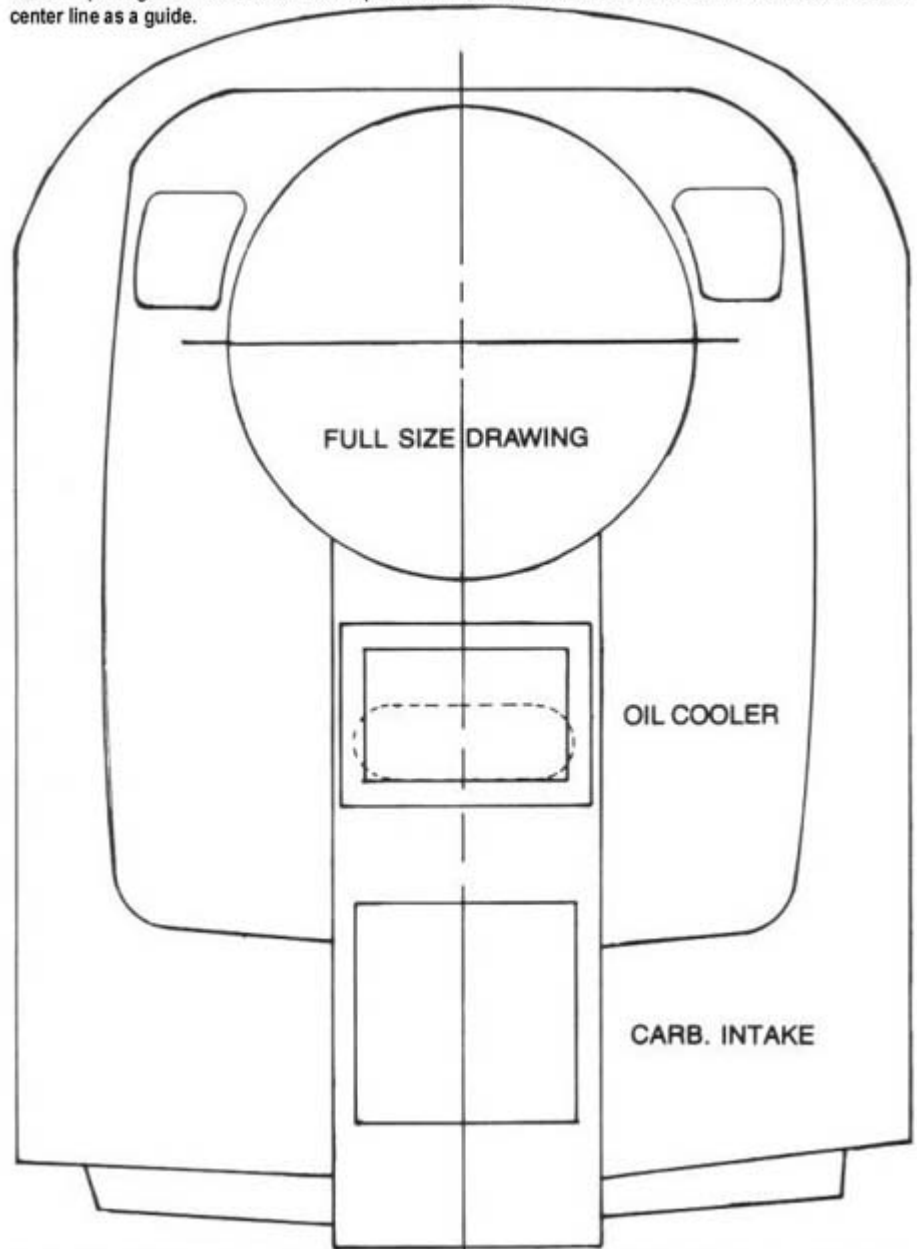

For the red and yellow scheme, use the drawing as it shows. For the red and white scheme, omit the two openings by the spinner and use the broken-line drawing for the slot in the oil cooler position. The carb intake is the same on both schemes.

- 94.
- With the engine mounted, tape the cowling into its final position on the fuselage. Check its fit by temporarily placing the 3" spinner on the prop shaft. When viewed from the side, the spinner should blend perfectly into the top curve of the cowling. Be sure to leave at least 1/16" clearance between the spinner and the cowling.
 - Drill the pilot holes through the cowling and into the fuselage sides in six places using a 1/16" drill bit. The top holes on each side should pass directly through the spruce longeron. The bottom hole on each side should also pass through the bottom spruce piece of the fuselage main frame. Remove the cowling.
 - Redrill the six holes in the fuselage with a 11/64" drill bit for the threaded inserts. Using the 4-40 x 1/2" panhead screws, thread the screws into the insert and place a small drop of 5 minute epoxy or slow CA on the insert. Be careful not to get any glue on the threads of the insert or the exposed threads of the screw. Screw the insert into the fuselage until the insert is flush with the fuselage side. When the glue dries the screws can be removed.
 - Redrill the holes in the cowling with a 1/8" drill bit.

95. Trim out the left and right plastic dummy engine cylinders using a knife or scissors. Use a sanding block to smooth the edges, leaving a 1/16" gluing flange around the cylinders and exhaust pipes. The cylinders can be glued to the cowling before or after painting using thin cyanoacrylate adhesive. Locate the cylinders as shown in the photo.

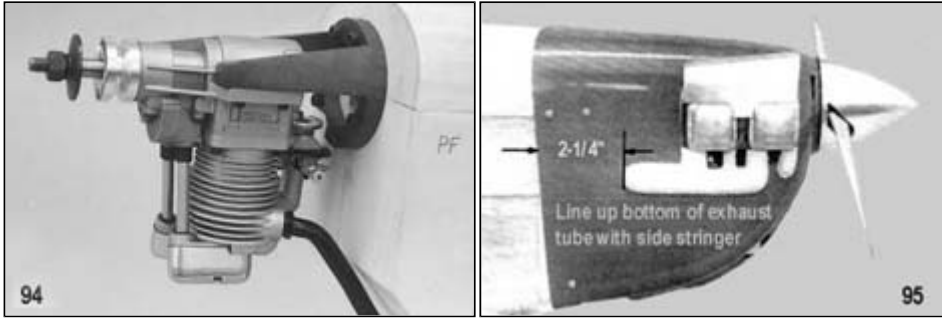

NOTE: Use the same dimensions shown here for the dummy engine on the left side of the cowling. Notice that, when viewed from the top, the right-hand cylinders will be staggered aft of the left-hand cylinders, just as they are on the full-scale Continental engine.

96. Cut out the cylinder shroud pattern and tape it to the plastic molding. Mark around the pattern and the back of the molding, remove the pattern, and carefully cut out the cylinder shroud. Flip the pattern over and use it to mark the other side of the molding. The shrouds may need a little trimming for a perfect fit on the dummy cylinders. The top edge of the shrouds should be in contact with the cowling, just above the cylinders. The back flange of the shrouds should be pressed up against the back cylinder.

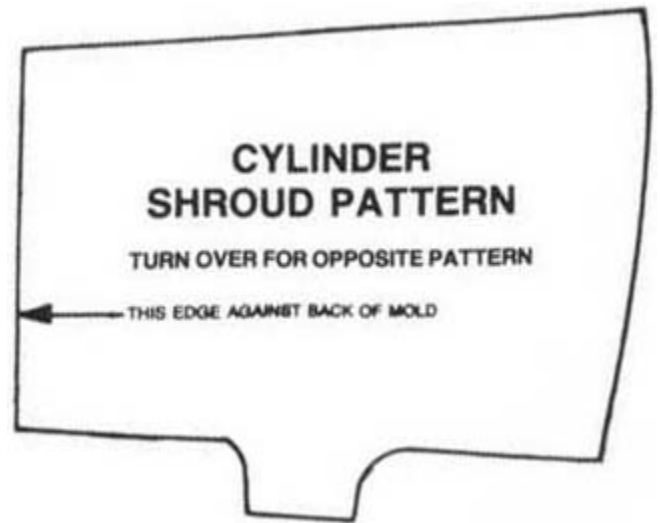

Wing Straps

Two pieces of 1/64"x7/8"x36" plywood are provided for optional wing straps to simulate the aluminum straps used by Maxey Hester on his full-scale Spacewalker II. The straps may be omitted from the model. Wrap the strips of plywood completely around the leading edge and cut off any excess at the trailing edge.

Fuel Cap Cover And Compass Assembly

The teardrop-shaped fuel cap cover should be trimmed from the plastic sheet leaving a 1/16" to 3/32" flange around the perimeter. The flange gives plenty of gluing surface and is scale. For best appearance, paint the cover separately and glue it to the finished fuselage with CA.

The molded plastic compass is assembled in a fashion similar to the plastic shock springs. Cut out the halves as close to the base as possible, then sand each piece until they match and the compass assembly appears round when the halves are held together. Glue the halves together using CA, dope thinner, or MEK as you did before. The "bulge" at the bottom of the compass was necessary for molding purposes and must be trimmed off after assembly. Paint the compass flat black before gluing it to the painted fuselage.

RADIO INSTALLATION

It is generally easiest to mount all of your radio equipment and pushrods in the model before covering and painting. Once the initial installation has been made and all the bugs worked out, you can remove the radio system and then reinstall it when the airplane is finished.

Mounting Servos in the Fuselage

The fore and aft location of the servos is generally not critical for balancing purposes. The servos in the photo model were mounted towards the rear of the radio compartment to help keep the pushrod lengths as short as possible. Use wood screws to mount your servos directly to the hardwood servo rails. Cut two servo rails from the 3/8" sq. spruce provided in the kit and epoxy them across the inside of the fuselage with the proper spacing for your servos. Glue scrap pieces of balsa to the fuselage sides around the ends of the servo rails so that they can never come loose in flight.

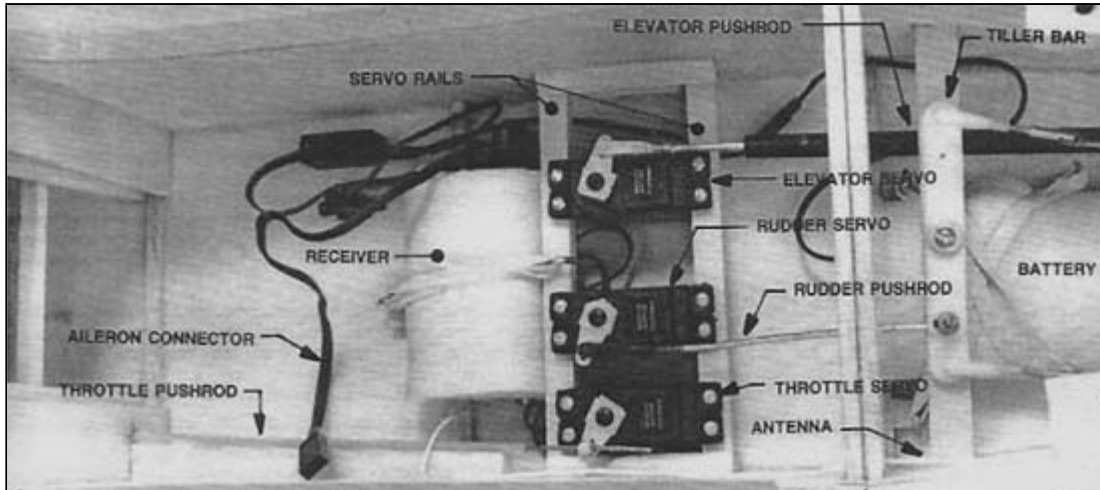

Elevator Hookup

Instructions for assembling the fiberglass elevator pushrod are on the plans (Plate 3). Use 3/32" dia. music wire and a 4-40 solder clevis (supplied in the kit) at the servo end of the pushrod. Notice that after the fuselage is covered, a pushrod exit slot will have to be cut into the fabric. We suggest that you duplicate the full-scale practice of reinforcing around a cutout in the fabric using a thin plastic reinforcement cut from scrap ABS. Use the pushrod exit reinforcement pattern. Apply it to the covering by brushing clear dope on the fabric and pushing the reinforcement onto the wet paint. When dry, the plastic should be firmly bonded and the fabric inside the ring can be cut out with a sharp knife.

Pushrod Exit Reinforcement

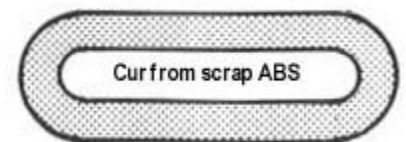

Rudder Hookup

A 4-40 threaded rod and clevis are supplied to serve as the rudder pushrod between the rudder servo and the tiller bar. Make a 90 deg. bend in the pushrod to engage in one of the inner holes on the tiller bar and use a wheel collar or soldered washer to permanently hold it in place.

Instructions for mounting the tiller bar and hooking up the rudder cables are on the plan (Plate 3). You can check your rudder hookup by watching its response to commands from the transmitter. If the rudder doesn't want to return back to neutral after letting go of the stick, the cables may need more tension or there is a bind somewhere in the system. Small discrepancies around neutral (1/16" or less) are okay, but larger variations are unacceptable. Be certain to periodically check the tension of the rudder cables as they may tend to loosen after several flights.

Throttle Hookup

All the materials to assemble a flexible-cable throttle pushrod as shown below are supplied in the kit. It should be supported at the servo end so that it is aimed directly at the output arm on the throttle servo. Cut a support block from scrap balsa and glue it firmly in place against the fuselage side. Epoxy the nylon outer tubing to the support block. Route the cable so that it makes as few curves as possible and provide at least one support between the servo and the firewall to keep it from buckling or flexing under load.

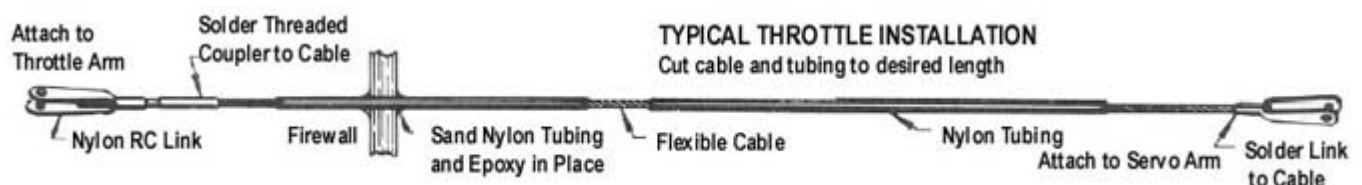

Aileron Hookup

In addition to a fifth servo, you will need to purchase two extension cords, a "Y" harness, and a single Horizontal Servo. All radio manufacturers have these items available as stock equipment. It is best to keep the extension cords as short as possible, 16" should be long enough when the "Y" harness length is added to it. Excessively long cords have been known to cause radio interference under certain conditions.

Temporarily fit the 1/8" die-cut Lie-Ply servo mount between the W-3 ribs, but don't glue it in place yet. Mount the servos to the Horizontal Servo Tray with four screws that are supplied with the tray. Now drill two 1/8" dia. holes through the tray, one on either side of the servo. These holes will allow the installation and removal of the servo tray with 4-40 x 3/16" machine screws.

Position the tray on the plywood servo mount in the wing, making sure that the servo arm is lined up with the slot in the servo bay sheeting. (Keep in mind that both servos must be located towards the outer end of the wing so that the ailerons will work properly when plugged into the "Y" harness.) When you have the servo lined up, use a pencil to mark the plywood mount at the two holes in the plastic servo tray.

Remove the servo tray and servo mount from the wing. Drill the plywood servo mount at the marks with a 9/64" drill bit, then glue in two 4-40 blind nuts. Reinstall the servo mount back in the wing, this time gluing it in place. Reinforce the glue joints with two short lengths of 3/16" sq. balsa.

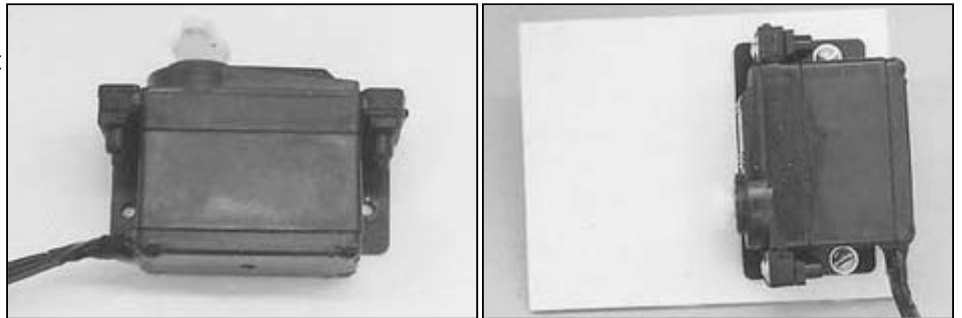

Receiver and Battery

Wrap the receiver and battery pack separately in foam rubber (such as SIGRF240), held on with rubber bands or tape, to protect them from engine vibration. The best location in the fuselage for the receiver and battery can't be determined until your model is completely finished. Shifting these components fore or aft can help get the model balanced properly. Be certain that both are secured into position so that they can't shift around in flight.

The receiver antenna can be run out of the bottom of the fuselage and taped at the aft end. This will expose the antenna without making it too conspicuous. It may also be mounted inside the fuselage in a long piece of nylon tubing glued into one of the corners. The switch and charging jack can be mounted on PT-1 in the cockpit opening for easy access.

WARNING - DANGER! -Important: Read These Warnings:

- Do Not fly control line or towline models within 300 feet of electric power lines. Instant death from electrocution can result from coming near them. Direct contact is not necessary.
- A model airplane motor gets very hot and can cause serious burns. Do not touch the motor during or after operation.
- Keep clear of the propeller. It can cut off a finger or put out an eye. Make sure the propeller is securely fastened in place and is not cracked.
- Model airplane fuel is flammable and poisonous. Take the same precautions while transporting and using it that you would with a can of gasoline or a bottle of poison.
- Remember that it is possible to lose control of a model airplane. Do not fly in locations where the model may hit people or damage property if loss of control occurs.
- Check your model and equipment regularly to insure it is in safe operating condition.

ENGINE INSTALLATION

There are many engines available today that are suited for the Spacewalker II, and each one has features that will require some amount of thought and engineering. Builders also have their own preferences regarding mufflers, engine mounts, etc., so nearly every Spacewalker II model will have something of a custom engine installation.

When choosing an engine, keep in mind the type of performance that you wish the model to have. If you want great aerobatic capability and vertical performance, use an engine towards the upper end of the recommended size range. If you want more scale-like flying qualities, engine size towards the bottom of the range may suit you better. Keep in mind that even engines at the bottom of the range will put a Spacewalker II through most aerobatic maneuvers.

The engine shown here is a Saito 120, mounted inverted on a Dave Brown glass-filled mount, #1204. The Saito 120 can also be side-mounted (cylinder horizontal), but it will stick out of the side of the cowl and interfere with the dummy engine cylinders. It would also need a higher fuel tank location, requiring you to cut into the plywood top, which is not recommended.



This particular engine installation has worked well without any on-board ignition system. However the reliability of most glow engines will be improved by on-board "glow", and the Spacewalker II is certainly capable of hauling the extra weight. An on-board ignition system uses a battery carried in the aircraft to keep the glow plug "hot" at all times (or just at low throttle, depending on the system.) On-board glow will also allow you to start the engine without hooking up an external battery. On this installation, a starting battery with a long extension is passed through a hole in the bottom of the cowl to engage the glow plug.

Most engines will require an extension on the needle valve to bring it to the edge of the cowling so that the mixture can be easily adjusted. We used a length of brass tubing, soldered to the needle valve at one end and soldered a 4-40 socket head bolt to the other end. A 4-40 balldriver is used to adjust the needle through a small hole in the cowling while the engine is running. The socket head/balldriver technique works especially well because the tool doesn't want to vibrate out of place like a screwdriver might.

Another Spacewalker II prototype used an O.S. 120 Twin for power. This is a twin, four cycle engine that provides flawless performance and reliability. Enough power to put the Spacewalker II through all the aerobatics that most sport pilots are capable of performing!

As you can see, custom exhaust extensions were fabricated for each cylinder from brass tubing, and routed to the air exit opening in the bottom of the cowl. This engine uses the same type of socket head needle valve extension described earlier.



The main things to remember when installing your engine are generally common sense, but are listed here to help those builders with little experience.

- a. Make certain that the engine is mounted solidly and all bolts are tight
- b. Use a muffler! The exhaust tubes should be routed through holes in the bottom of the cowling or out the cooling air exit. Long extension tubes must be braced or clamped to the structure to avoid damage from engine vibration.
- c. Provide a simple means of adjusting the needle valve setting without having to remove the cowling. There should also be easy access to fuel lines, glow plus, etc.
- d. Be sure that no parts of the engine, exhaust system, or spinner come into contact with the cowling.

Propellers

Use only those propellers recommended in the instructions supplied with your engine.

Spinners

The 3" dia. Tru-Turn spinner is shown on the plans. It has a true scale shape and diameter. Of course, other spinners may be used, but they may not have the correct scale appearance. Tru-Turn spinners are machined from aluminum bar stock and are of a very high quality. Also be sure to get the proper Tru-Turn prop nut assembly to fit your engines.

COVERING AND PAINTING

For the strongest, most durable, and most realistic finish on your framed-up Spacewalker II, we recommend that it be covered with some type of fabric, such as Sig Koverall. No matter what you choose for covering material, it will not conceal a rough framework. Be sure all surfaces are sanded smooth before proceeding.

The manufacturer's directions for applying iron-on coverings are packed with the material. Follow these closely, for different types of material have different iron temperatures and techniques of application. The rest of these instructions describe the use of Sig Koverall.



Koverall is a polyester-base, heat-shrinkable, synthetic fabric much like the covering used on full-scale aircraft such as the Spacewalker II. Its toughness makes it ideally suited to giant-scale model aircraft - we've used it successfully on all of our Spacewalker II prototypes. It is relatively low cost and will add a great deal of strength to the model's framework. It can be applied to the model using dope or Sig Stix-It, a heat-activated adhesive.

Surface Preparation

Whichever application method is used, you should first brush two coats of clear dope onto the framework wherever the covering material makes contact (even the capstrips on the wing). If you plan to use dope for the entire finish, use Sig Supercoat (butyrate dope) for the first two coats. If you plan to use enamels or epoxy colors, use Sig Nitrate dope. Lightly sand after each coat to remove any raised grain or fuzz.

Applying Koverall With Dope

The bottom of the wing is a good place to start covering. Cut a piece of material about an inch larger all around the panel, with the grain running spanwise. (The grain of woven materials runs parallel to the finished bias edge.) Lay the Koverall on the wing, pulling out any major wrinkles. Koverall shrinks up considerably under heat - there's no need to worry about such things as packaging fold creases because they will come out easily with the iron. Brush clear dope around all the edges. This will soak through the fabric and adhere it to the dope already dried into the framework. Allow the dope to dry before trimming off the excess material with a sharp razor blade. Check for any rough edges or places that are not stuck down properly and apply more dope, let dry.

Applying Koverall With Stix-It

Directions for applying Koverall with Stix-It are on the can. The basic procedure is to apply Stix-It around the edges of the framework where you want the covering to attach. When dry, the fabric can be ironed-on around the edges where the Stix-It was applied.

Shrinking and Sealing Koverall

After both sides of a surface are covered, shrink the Koverall evenly with an iron or hot-air gun (read the Koverall package instructions). The fabric can now be sealed with three or four coats of clear dope. Thin the dope until it brushes on easily and flows out smooth (about 25% to 30% thinner). The first coat should be applied sparingly to avoid puddles underneath the fabric. The second coat will seal most of the pores of the Koverall and from then on running through will not be a problem. Sand the model VERY LIGHTLY with FINE sandpaper after the second coat is dry. The next two coats will completely seal and begin to fill the weave of the fabric. When dry, sand again. Your Spacewalker II is now ready to be finished with its colored paint scheme.

Some Notes on Covering the Spacewalker II

The covering on the wing can be extended to cover the entire ABS wingtip. This will add a little strength to the tip and provides a more consistent surface for the paint.

The fuselage can be covered two different ways. The easiest method is to use four separate pieces of material; one for the bottom, two for the sides, and one for the turtledeck, applied in that order. The turtledeck piece should end about halfway on the small dorsal fin (R-6).

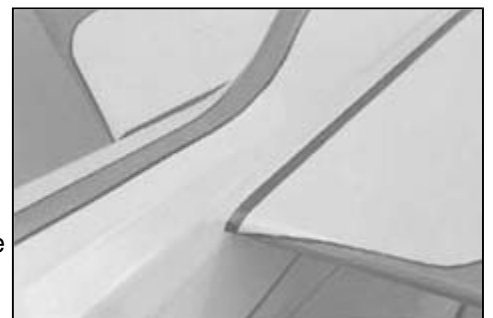

The covering material for the fin is then overlapped 1/4" onto the turtledeck fabric. This does leave a seam, but it can be mostly hidden by applying a few extra coats of dope in this area and sanding lightly. This method was used on the photo model and the seam is hardly noticeable.

A perfectly smooth fin fillet can be achieved by covering the fuselage with three pieces of material; one for the bottom and another two, each covering one fuselage side, half the turtledeck, and one side of the fin. This method is a little trickier, but it does produce fewer seams. Don't shrink the fabric until all of the pieces have been firmly attached to the framework. No matter which way you cover the fuselage, the fabric on the fin should attach to the first 5/16" sq. balsa rib up from the bottom.

Paint Schemes

The eye-catching "spike" paint scheme used on Maxey Hester's yellow and red Spacewalker II was painted with Ditzler's Durathane. Maxey's colors can be duplicated using Sig Supercoat Dope in the formulas to the right.

Paint Formulas to Match N516HM	
YELLOW	RED
<ul style="list-style-type: none">• 2 PARTS SIG LEMON YELLOW• 1 PART SIG CUB YELLOW• 1 PART SIG WHITE	<ul style="list-style-type: none">• 1 PART SIG LIGHT RED• 1 PART FOKKER RED

Of course, Sig Cub Yellow and Sig Light Red can be substituted if you aren't interested in a perfect color match. We've found that a light coat or two of Sig White dope provides an even base for the colored dope and actually reduces the total amount of paint necessary. It is generally better to apply light colors first, followed by darker trim colors.

Maxey's original full scale paint scheme was red and white and was painted with Sig Supercoat Light Red and White.

The paint scheme patterns given on the plans can be used for either aircraft. The patterns can be cut (or traced) from the plans and positioned directly on the airplane. Draw around the pattern lightly with a soft lead pencil, remove the pattern, and mask off the surface using the lines as your guide. We use "low-tack" drafting tape to mask off paint schemes on our models. Seal the edge of the tape with a coat of clear dope before applying the trim color. If you have used Sig Supercoat Dope throughout, a final coat of clear over the color paint will add a nice gloss to the finish. Do not try to mix different brands of paint. Use Sig products from the start and follow the instructions that come with them carefully for best results.

The pin stripes on both airplanes really help to set off the colors. We used 1/16" wide tape on the model and it looked just fine even though it wasn't scale.

Other homebuilt Spacewalker IIs should be appearing shortly all around the country with other paint schemes. If you are not particularly interested in scale competition, you will probably want to come up with your own design.

Painting the ABS Plastic Parts

The plastic parts should be sanded to remove the gloss before they are painted. Use only 220-grit or finer sandpaper. We recommend that the plastic parts be painted with Sig Supercoat Dope for best results. Sig Plastinamel, Hobbypoxy, K&B Superpoxy, and Dulux (automotive) enamel have also been proven compatible with ABS plastic and can be used if desired. K&B primer may also be used for a smooth undercoat. Do not use other paints, dopes, or finishes without first testing to make certain it is compatible with the plastic.

CAUTION: Do not try to cover the ABS plastic parts with Monokote or other iron-on types of covering material. The heat may melt and distort the plastic.

Decal Application

All the decals necessary to duplicate N516HM are supplied in the kit. Notice that the curved Spacewalker logos have been pre-aligned with the little spacemen so that they can be applied in one piece.

Model fuels are hard on decals. Even if you are using no nitromethane in your fuel, the oil can still get under the decals and loosen them. Try to direct your exhaust out to an area without decals. Coating the decals with auto paste wax will help protect them, but the wax must be replaced at regular intervals. If needed, replacement decals are available from Sig.

- Cut out the decals with a pair of sharp scissors. Leave about 1/32" to 1/16" of clear edge around the decal. Round the corners as you are cutting.
- Wet the surface on which the decal will be placed with soapy water (use dishwashing detergent).
- Place the decal on the model and squeegee the water from underneath with a balsa paddle and allow to dry.

This procedure will prevent air from being trapped underneath as is possible when the decals are applied dry.

Interior Detailing

Some modelers enjoy spending many hours providing their models with intricate detailing, while others spend no time at all. The cockpit area of your Spacewalker II can be given as much scale detailing as you wish, however no materials (except for the plywood instrument panel) are provided in the kit. The following recommendations will add immensely to the overall impact and realism of the model without taking too much time.

Paint the Interior

The wood inside the cockpit must be protected with several coats of clear dope. Once it is sealed, some flat black or gray painted on the exposed areas will help give a less obtrusive appearance.

Instrument Panel

Maxey Hester used a plywood panel in their airplanes, so the die-cut 1/16" plywood instrument panel provided in the kit will appear very realistic when finished with several clear coats of dope or varnish. Several manufacturer's make 1/4-scale aircraft instruments that can be fitted to the panel to give your model an added touch of realism. After painting and adding details to the panel, it can be glued permanently in place.

Pilot

A few manufacturer's also produce 1/4-scale pilots that are easily painted and mounted to the plywood top. Notice that the pilot should be placed well towards the back of the cockpit opening.

Pre-Flight Checkout

Be certain to range check your radio equipment according to the manufacturer's instructions before attempting test flights. A lot of problems can also be avoided if your engine has been well broken-in and the idle adjustment perfected on a test stand or in another airplane before installation in the new model.

RECOMMENDED CONTROL SURFACE MOVEMENTS	ELEVATOR	3/4" UP and 3/4" DOWN
	RUDDER	1" LEFT and 1" RIGHT
	AILERON	1" UP and 3/4" DOWN

For test flights, the following are suggested:

The control measurements listed above should give full aerobatic capability if your Spacewalker II is properly balanced. Test flights may indicate a need for more or less movement, depending on individual model performance and personal preference.

Balance your model somewhere in the C.G. (Center of Gravity) Range shown on the plans. For test flights it is better to balance in the forward portion of the range than in the rearward portion. Add weight to the nose if necessary - trying to fly with the C.G. too far back is much more dangerous than the slight increase in wing loading caused by adding lead to the nose!

FLYING

The Spacewalker II has proven to be one of the most exciting models that we've ever flown. Although it will perform the full range of aerobatic maneuvers, it will settle down for slow, stable landing approaches and touchdowns. It's a fun and easy aircraft to fly, but it is not a basic trainer. Do not attempt to fly your Spacewalker II unless you've logged some flight time on other low-wing aircraft. Have an experienced pilot assist you, particularly on test flights.

In the air, you will find the Spacewalker II to be very smooth and stable. It's aerobatic capabilities will definitely please any sport pilot. After the model has been trimmed and you are more familiar with its flying qualities, you may want to experiment with slight changes in control surface travel and balance point until the model flies and reacts just the way you like it. Advanced pilots who are striving for maximum realism and smoothness should "coordinate" their turns by adding a small amount of rudder at the same time, and in the same direction, as the aileron. Many of the newer radio systems offer a "coupling" feature which will automatically deflect the rudder slightly when you use the aileron stick. We have used this feature successfully on our Spacewalker IIs. The proper amount of rudder movement is about 1/2" each direction with full deflection of the ailerons.

When the time comes to land your Spacewalker II, remember to keep your control inputs smooth and gentle to avoid overcontrolling. When you are certain that the model will make it to the runway (even if the engine quits), bring the throttle to full low and concentrate on keeping the wings level during final approach. Slow the model down during the entire approach by slowly feeding in up elevator. Just before the model touches, flare the landing by carefully feeding in more up elevator. Hold the model just inches off the ground until your elevator stick is pulled all the way back. The Spacewalker II should settle down to a perfect "threepoint" landing with a short rollout. Taxi back slowly and graciously accept all the praise offered by onlookers. Your Spacewalker II will surely be the hit of the flight line!

WINDSHIELD PATTERN

INSTALLING THE WINDSHIELD

Cut out the windshield pattern and place it on the 5" x 12" clear plastic material provided in the kit. Trace around the pattern (a ball point or permanent-ink felt pen work well for this), then cut it out using a knife or scissors. The edges of the plastic may be sanded smooth, but be careful not to scratch the flat surfaces.

Cyanoacrylate adhesive works best for gluing the windshield to the painted fuselage. (Don't use CA "accelerator" or "kicker" which could permanently fog your plastic windshield.) A little patience during this step will usually be rewarded with a neat-looking installation.

With the windshield taped down in its final position, tack glue it in several places along its edges. Then go back and glue the edge permanently, removing the tape as you go.

JOIN

JOIN

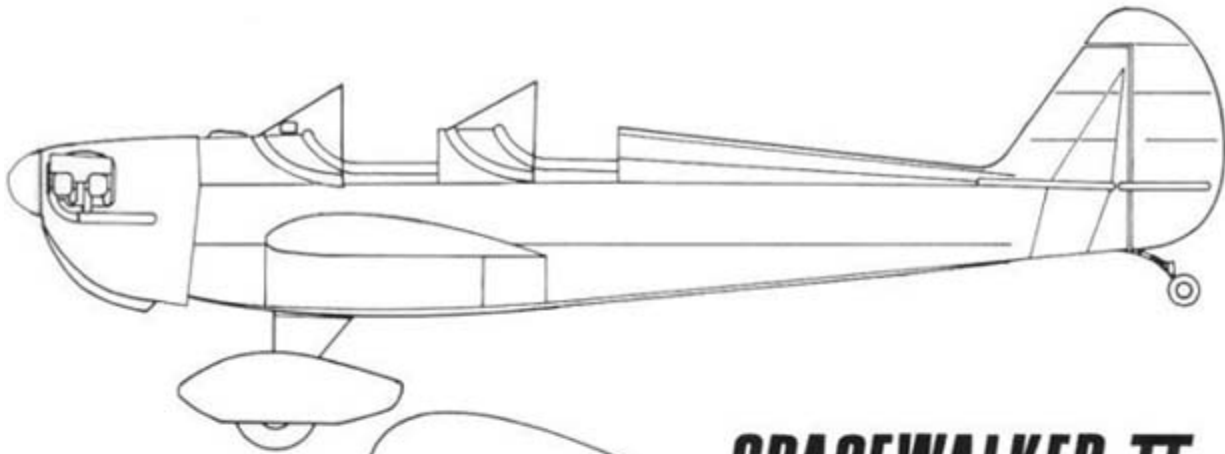

SPACEWALKER II

SPECIFICATIONS

WINGSPAN	28 ft.
WING AREA	123 sq. ft.
LENGTH	20 ft.
WEIGHT	760 lbs.
ENGINE	100 h.p. Continental

PERFORMANCE

TOP SPEED	125 m.p.h.
CRUISE SPEED	105 m.p.h.
STALL (POWER OFF)	54 m.p.h.

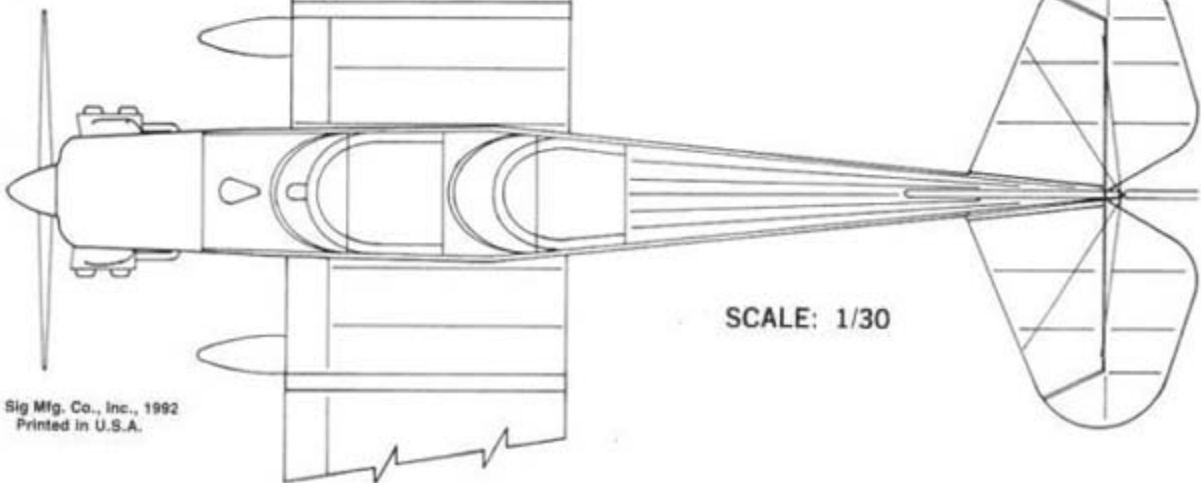
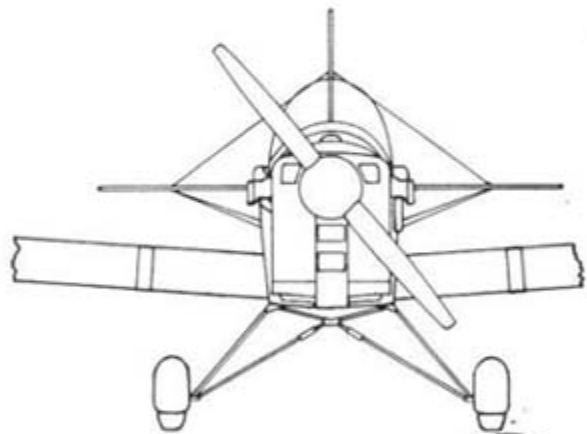

SCALE: 1/30

© Sig Mfg. Co., Inc., 1992
Printed in U.S.A.

© Copyright SIG Mfg. Co., Inc.

SIG MFG. CO., INC.....Montezuma, Iowa 50171-0520

LIMIT OF LIABILITY:

In use of our products, Sig Mfg. Co.'s only obligation shall be to replace such quantity of the product proven to be defective. User shall determine the suitability of the product for his or her intended use and shall assume all risk and liability in connection therewith.