

Craftsman's Kit
SIGRC55

Astro-Hog



Building and Flying Instructions

THE ASTRO-HOG STORY

The Astro-Hog is one of modeling's classic designs. Its appearance on the scene in 1957 changed the course of radio control aerobatics. Up till that time, R/C pattern flying consisted mainly of clumsy looking maneuvers performed by over-stable, high wing, free-flight style models that were primarily steered by rudder alone. The Astro-Hog was the first successful low-wing aileron-controlled R/C model, designed by Fred Dunn of California. Its flight performance was revolutionary - smooth, graceful, controlled maneuvers were now possible! The Berkeley Model Company quickly came out with a kit of the Astro-Hog, and it became a common sight at flying fields everywhere. Astro-Hogs made a clean sweep of 1st, 2nd, 3rd, and 4th place at the 1958 National Championships.



Model Airplane News magazine, in its April 1958 issue, proclaimed: "An airplane to top anything so far in multi R/C. Out of this world maneuverability!" (A report of that MAN article is included in this kit.)

The Astro-Hog kit production came to a premature end in 1961 when the Berkeley Company went out of business. Though it had only been on the market for 3 years, the Astro-Hog had established itself as a legend against which new designs would be measured.

The flight characteristics that made the Astro-Hog so popular back then are still perfect for today's flier. A thick semi-symmetrical airfoil, large wing area, and light wing loading give it perfect stability plus great maneuverability. It will perform any maneuver in the book, yet flies slow enough to let you enjoy it. The Astro-Hog makes an ideal first low-wing trainer for learning pilots, or it can be the ultimate fun machine for experienced fliers.

THE RETURN OF THE ASTRO-HOG

Sig Mfg. Co. now owns the old Berkeley kit line. This modern version of the Astro-Hog, is a faithful copy of the original with these improvements.

1. Simplified construction - The inner structure of the model has been redesigned to make it quicker and easier to build.
2. The wing dihedral has been reduced from the original 8" under each wing panel to 6" per panel (12" total).
3. Strip ailerons are provided instead of the original "barndoor" style. Strip ailerons have dominated model design since the days of the Astro-Hog because they are much easier to build and install; have no slop or play in their movement; and they will roll a model just as well as the barndoor style. No materials are supplied in this kit for making barndoor ailerons.
4. Bolt-on wing mounting is provided instead of the original rubber band wing mounting. No materials are supplied for making the old rubber band mounting.
5. The stabliizer is now permanently mounted on top of the fuselage sides, instead of the original rubber band mounting onto the bottom. No materials are supplied for making the old style mounting.
6. Tricycle landing gear has been incorporated into the redesigned Astro-Hog as standard equipment, to provide trouble-free ground handling by pilots of all skill levels. The materials and standard construction sequence in this kit are for building the trike gear installation. (*see note below).

These changes from the original design make it easier than ever to build and fly an Astro-Hog. Nothing has changed that alters the airplane's legendary flight characteristics. The materials supplied in this kit are for building this modern Sig version of the Astro-Hog as shown on the kit box label. The "Optional Taildragger Conversion" is the only modification of the kit we endorse.



FRED DUNN with his original Astro-Hog

Optional Taildragger Conversion

There may be some of you, especially veteran fliers, who will want to convert your Astro-Hog back to the original taildragger landing gear for aesthetic reasons. On plate 2 of the full-size plans, you will find all the patterns necessary to convert back to the taildragger version. Also in section 15 there are instructions on making the installation. Decide now whether you want to make this modification and plan accordingly.

COMPLETE KIT PARTS LIST

COMPLETE KIT PARTS LIST			
Die-Cut Balsa Sheets			
2 Sheet No.1 W1, W4, FSD, S1	6 Sheet No.2 W2, W4	2 Sheet No.3 W3, W4, W5A	2 Sheet No.4 W5, W6, W1A, W1B
2 Sheet No.5 TB-1, TB-2, TB-3, TB-4, TB-5, TB-6	1 Sheet No.6 F5A, F1C, F3, F4		
Printed Balsa Sheets			
1 Sheet No.7 Right Fuselage Side	1 Sheet No.8 Left Fuselage Side	1 Sheet No.9 FN-1, FN-2, FN-3	1 Sheet No.10 S-2
1 Sheet No.11 Cowl Side Doublers, Wing Filler Blocks, Tail Fairing Blocks			
Sheet Balsa			
6 3/32x4x36 Fuse Top Sheeting, Wing L.E. Sheeting	5 3/32x3x36 Sheeting for Stab & Wing Center-Sections, Fuse Bottom	4 3/32x1-1/4x30 Wing T.E. Sheeting	
Block Balsa			
1 1/2x4-3/16x6 Nose Bottom Block	1 5/8x3-3/16x4-1/2 Cowl Bottom Block	1 3/4x1x3-3/16 Cowl Top Filler Block	2 3/4x2-1/2x2 Wing Fairing
Stick Balsa			
3 3/16x5/16x36 Stab Ribs	5 3/32x3/16x36 Capstrips	2 1/8x9/16x36 Leading Edges	2 3/16x3/4x36 Leading Edge Cap
5 3/16x3/16x36 Top Stringers, Bottom Middle Stringer	2 3/16x3/8x30 Stab Spars	6 1/4x1/4x36 Corner Stringers, Uprights & Tip Braces	6 1/4x1/2x30 Cross Braces, Main Spars & Spar Doublers
2 1/4x5/8x30 Trailing Edges	3 5/16x5/16x30 Stab T.E. & Pushrods	1 1/2x1/2x18 Triangular Stock for Fuselage	1 3/4x3/4x6 Triangular Stock Wing Bolt Support
1 1x1x6 Triangular Stock for Cowl			
Special Shaped Balsa			
1 1/4x3x10-1/2 Tapered Stock for Rubber	2 1/4x3x13-1/2 Tapered Stock for Elevators	2 1/2x1-1/2x36 Shaped Aileron Stock	

Hardwoods							
1	1/4 Dia. x6-1/2 Dowel Elevator Joiner, Wing	2	3/4x3/4x1-1/2 Basswood Wing Bolt Blocks	2	3/8x3/4x6-1/4 Basswood L.G. Blocks	2	3/8x3/4x3/4 Maple L.G. Anchor Blocks
1	5/16x5/16x36 Spruce L.E., Stab L.E. Doubler						
Music Wire							
1	5/32 Dia. Coiled Nose Gear	2	5/32 Dia. Formed Main Gear	2	Formed Left & Right Aileron Torque Rods	1	1/16 Dia.x12 Straight Wire for Pushrod Ends
Plastic							
1	.015 Clear for Windshield	1	ABS Molded Headrest				
Hardware							
20	Molded Poly Hinges	2	1/4x20 Nylon Wing Bolts	2	Nylon Control Horns; elevator, rudder	12	#2x3/8 Sheet Metal Screws; control horns (4) L.G. straps (8)
1	5/32 Nylon Nose Gear Bearing	1	5/32 Nylon Steering Arm	1	6-32x1/4 Set Screw; for steering arm	4	4-40x3/8 Mounting Bolts; for nose gear bearing
4	4-40 Blind Nuts; for nose gear bearing	2	Aluminum Engine Mounts	8	6-32x3/4 Mounting Bolts; engine mounts (4), engine (4)	4	6-32 Blind Nuts; engine mounts
4	Nylon L.G. Retaining Straps	2	Nylon Aileron Connectors	4	2-56x10 Threaded Rods; ailerons (2), rudder (1), elevator (1)	5	Nylon R/C Links; ailerons (2), rudder (1), elevator (1), throttle (1)
1	2-56 Threaded Coupler; for throttle pushrod	1	Pushrod Connector Assembly				
Miscellaneous							
1	Plan Plate 1	1	Plan Plate 2	1	Instruction Book	1	2x24 Fiberglass Tap; for wing center section
1	1/8 od x32 Nylon Tubing; throttle and nose gear pushrods	1	1/16x32 Steel Cable; throttle and nose gear pushrods				

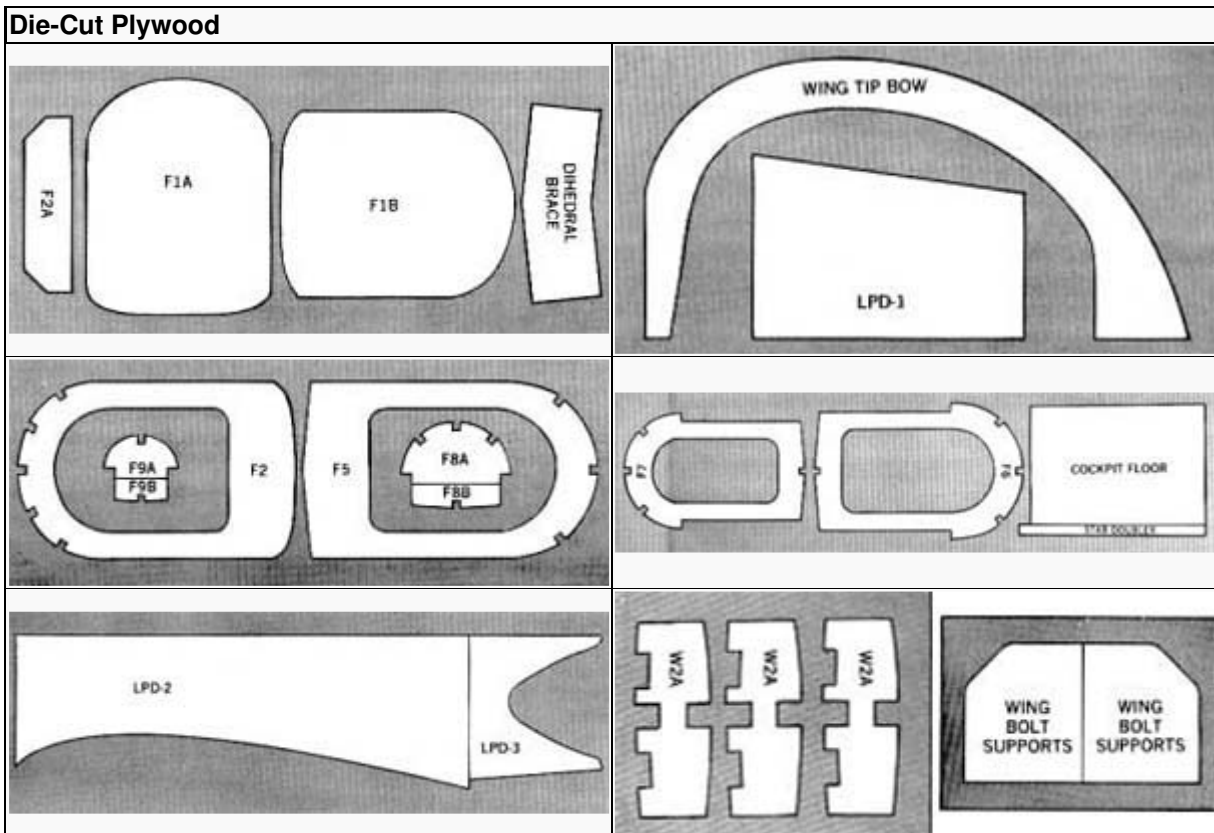

RADIO EQUIPMENT REQUIREMENTS

For best results, we recommend that you install 4-channel radio equipment in your Astro-Hog to operate the ailerons, elevator, rudder and engine throttle. The Astro-Hog's fuselage is spacious enough that any common brand of radio equipment with standard size servos and battery pack can be used.

ENGINES AND MUFFLERS

The Astro-Hog can be flown with a wide range of glow engines, either the 2-stroke or 4-stroke type. Because of its light wing loading (about 20oz/sq.ft. - similar to a "Cub" type trainer), a lot of high revving power is not needed. The Astro-Hog was designed to fly at slower airspeeds than today's typical pattern models.

In a 2-stroke cycle glow engine, we recommend .45 - .60 cu. in. displacement. A good .45 or .50 is adequate if the model is kept light, preferably 7 pounds or slightly less. If you fly off a grass field, live at high altitude, or just prefer a little reserve power, a .60 size engine would be a better choice. A non-schneurle .60 (like the venerable Webra .61 Blackhead, Veco or K&B .61 Enya .60 III etc.) makes an ideal powerplant for the Astro-Hog in most cases.

A .60 size 4-stroke cycle glow engine is also a very popular choice for the Astro-Hog. Typically, 4-stroke engines are quieter and more economical on fuel than an equivalent size 2-stroke. They develop their power at a lower rpm. Their realistic sound and performance blend perfectly with the Astro-Hog's flying style. Since 4-strokes don't produce quite as much power as the same 2-stroke, we do not recommend .40 - .50 size 4-strokes.

There is no one type of muffler that is best suited to the Astro-Hog. It all depends on the particular engine that you've elected to use. You will have to figure out your own muffler installation. However, since the Astro-Hog cowling is large and wide open, you will find that almost any normal muffler will work.



GLUES

There are so many different glues available today for model construction that it can be confusing for the newcomer. To simplify matters, most glues can be classified as one of four basic types:

- Easy to use water-base wood glues such as Sig Bond (yellow) and Sig Super-Weld (white).
- Super strong two-part epoxy glues such as Sig Kwik-Set (5 minute cure) and Sig Epoxy (3 hour cure).
- Traditional solvent-base model cements such as Sig-Ment.
- Fast cyanoacrylate "super" glues such as Zap, Hot Stuff, Jet etc.

Each of these types has different characteristics and advantages. Often times, the choice of which type to use is strictly a matter of personal preference based on your experience with a previous model. If you are new to the hobby and not sure what type to use, we recommend that you try Sig-Bond glue for the majority of the general Astro-Hog framework construction. It is a great all-purpose aliphatic glue that is easy to use. You should also have on hand some epoxy glue, either slow dry or 5-minute, for areas subject to unusual strain or involving metal pieces. Some of the steps in these instructions call out the type of glue to use for that particular assembly. In other areas you can use your own judgement as to which type is best suited to the purpose and to your building schedule.



CAUTION:

Some people have experienced allergic reactions when exposed to epoxy or cyanoacrylate glues. This is very rare. However, it is always important that such glues, and also paints, thinners, and solvents, be used with adequate ventilation to carry fumes away.

There are also a couple of places ahead in these instructions where it calls for "model putty" or "wood filler". We recommend Sig Epoxolite Putty, regular household spackling compound (DAP, Red Devil etc.) or automotive body putty (Bondo, etc.) for these instances.

NOTES BEFORE BEGINNING CONSTRUCTION

Any reference to right or left refers to your right or left as if you were seated in the cockpit.

To build good flying models, you need a good straight building board. Crooked models don't fly well! The building board can be a table, a workbench, a reject "door core" from the lumber yard, or whatever - as long as it is perfectly flat and untwisted. Cover the top surface of the building board with a piece of celotex-type wall board or foam board, into which pins can be easily pushed. Don't hesitate to use plenty of pins during assembly to hold drying parts in the correct position.

When pinning and gluing parts directly over the full-size plans, cover the plan with wax paper or plastic kitchen wrap to prevent gluing the parts to the plans.

Don't use a ball point pen for making marks on the model during construction. If not sanded off, these ink marks will show through the model's final finish. Use a pencil instead of a pen.

Balsa die-cut parts have identification numbers printed on them. The plywood die-cut parts do not. Use the diagrams in the "COMPLETE KIT PARTS LIST" above to mark the i.d. numbers on the corresponding plywood parts.

Leave all the die-cut parts in the sheets until needed in construction. Remove pieces from the sheets carefully. If difficulty is encountered, do not force the part from the sheet. Use a modeling knife to cut it free. A jig saw works best for cutting out the printed balsa parts. If a jig saw is not available, a sharp modeling knife and a straightedge can be used. Cut just outside the printed lines, leaving all of the line on the part. When fitting the piece into the structure, use a sanding block to bring the edges to an exact fit.

All of the other kit parts can be identified by the "COMPLETE KIT PARTS LIST". Sort the different sizes of sticks and sheets into individual piles to avoid confusion during building. Cut all long pieces of balsa first, followed by medium lengths, before cutting up any full length strips into short pieces.

Any model parts mentioned in these instructions, but not furnished with the kit, are marked by an asterisk (*).

SANDING BLOCKS

An assortment of different size sanding blocks are indispensable tools for model construction. A good general purpose block can be made by wrapping a full 9"x11" sheet of sandpaper around a piece of hardwood or plywood. Use three screws along one edge to hold the overlapping ends of the sandpaper. Put 80 grit paper on the block during general construction. Switch to 220 grit paper for final finish sanding just before covering,

Another handy block can be made by gluing sandpaper onto a 24" or 36" long piece of aluminum channel stock. Most hardware stores carry a rack of aluminum in various sizes and shapes. This long block is very useful for sanding leading and trailing edges accurately.

Finally, glue sandpaper onto different sizes of scrap plywood sticks and round hardwood dowels. These are handy for working in tight places and for careful shaping where a big block is too hard to control.

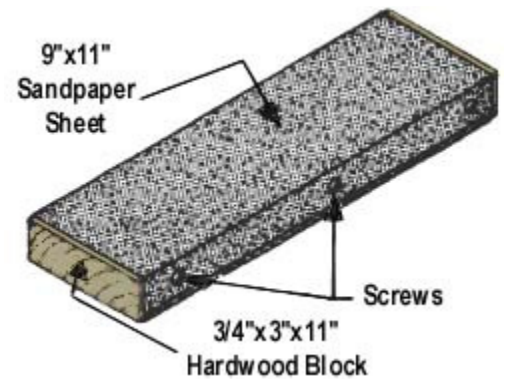

1. BASIC WING PANEL CONSTRUCTION

- a. Six pieces of 1/4"x1/2"x30" balsa are supplied for making all the top and bottom wing spars. Cut two of the 30" pieces into four 11-7/16" long spar doublers. Glue one spar doubler onto the end of each remaining 30" main spar. Pin them down straight and flat until dry.
- b. Glue the W2A ply doublers onto the W2 balsa wing ribs. Make three with the doubler on the right side of the rib and three with the doubler on the left. Align carefully and let dry!
CAUTION: Be sure to properly identify the front end of each W2A before gluing them to the ribs.

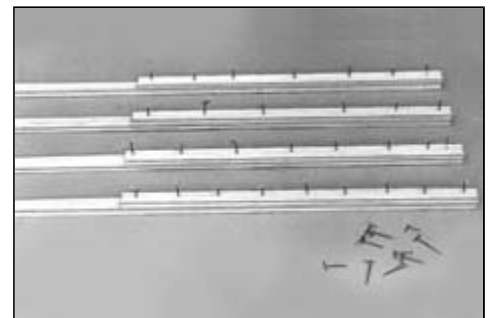

- c. Notice the notches for the grooved landing gear blocks have been pre-cut into the W2A ply doublers but not in the W2 balsa ribs. There are two sets of notches. Those in back of the main spar are for the standard trike gear installation, and those in front of the spar are for the optional taildragger installation. Cut open the balsa ribs to match the notches in the ply doublers for your choice of landing gear.

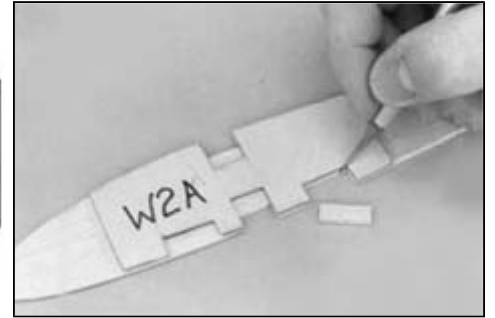
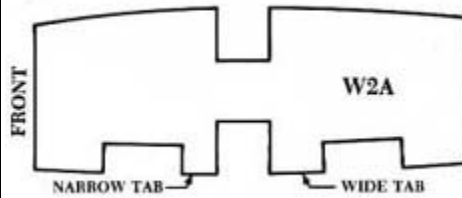
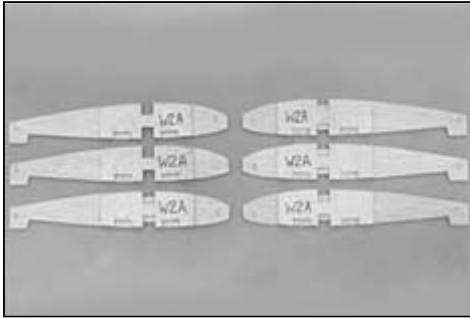

- d. Glue the die-cut balsa riblets W5A onto the ends of the W5 ribs. Make one right and one left. Let dry.

NOTE: The Astro-Hog wing consists of two separate panels - a right wing panel and a left wing panel. Each panel is first constructed by itself, entirely separate from the other, before they can be joined together later. Beginning with the next step e) the instructions are describing the assembly of one wing panel at a time.

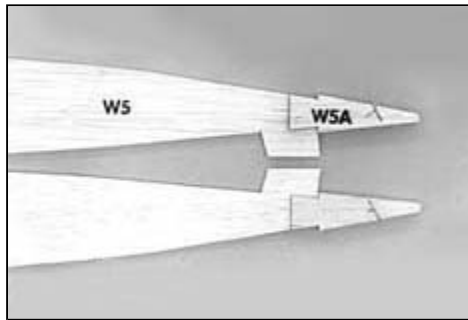

- e. Pin one of the wing panel plans to the building board and cover it with wax paper. Pin the 1/4"x1/2"x30" bottom spar assembly in place on the plan. Slant the pins rearward so that they can be easily removed later.
- f. Glue and pin balsa wing ribs W2, W3, W4, and W5 in place along the bottom spar. Use a small triangle or other 90 deg. object to make sure the ribs are vertical.
- g. Glue the 1/4"x1/2"x30" top spar assembly in place. The end of the spar doubler should fit snug against W3.
- h. A Dihedral Angle Gauge is pictured right. Cut it out carefully and glue it to a piece of cardboard or scrap balsa. Then glue the W1 center rib in place, using the guage to tilt the rib towards the wing tip.

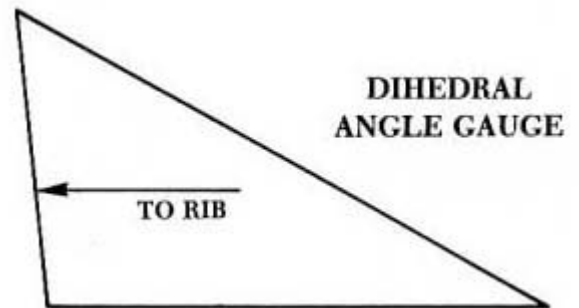

NOTE: This same Dihedral Angle Gauge is to be used for tilting the W1 rib in both wing panels. The angle of the guage is 6 deg., half of the total dihedral amount (12 deg.) of the finished wing.

- i. Glue in the die-cut balsa pieces W1A and W1B. When dry, use a sandpaper file to make sure they are not sticking above the tops of the ribs W1 and W2.
- j. Glue the 1/8"x9/16"x36" balsa leading edge onto the fronts of the ribs. Notice that the leading edge must extend on past rib W5 into the wingtip area - don't cut it off too short!

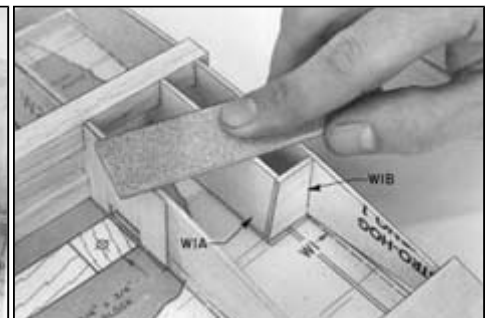
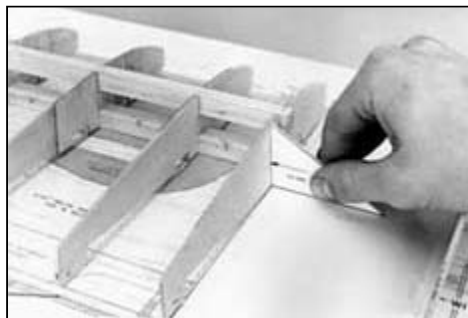

- k. Glue in place the 3/32"x1-1/4"x30" balsa trailing edge top sheeting. The rear edge of the sheet should be flush with the ends of the ribs. If your sheet is bowed a little, any slight overhang past the ends of the ribs will be sanded off later.
- l. Glue the die-cut balsa wingtip parts TB-1, TB-2, TB-3, TB-4, TB-5, and TB-6 on top and bottom of the die-cut lite-ply wingtip bow. Pin flat until dry.
- m. Glue the laminated wingtip bow in place on the end of the wing panel. The outer edge of the tip bow should be blocked up 1/2" off the building board. The inner two ends of the bow should be centered directly over the datum line of rib W5 (datum line is from the leading edge to the trailing edge centers. See cross-section.).

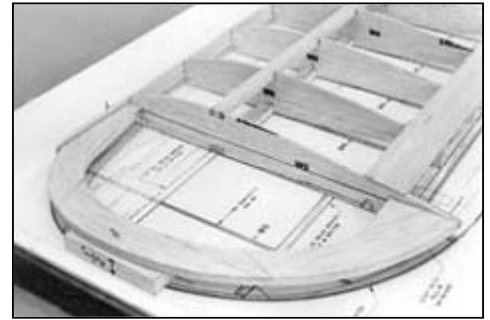
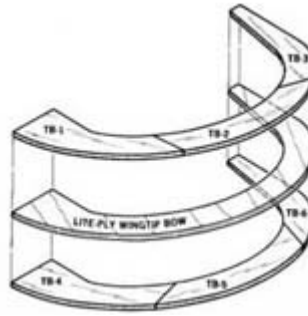
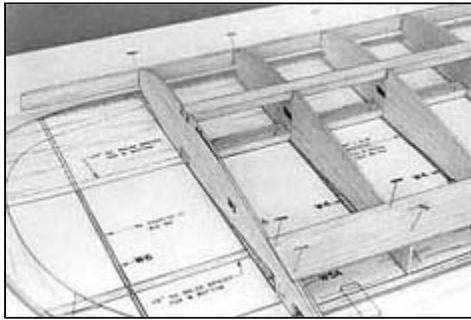
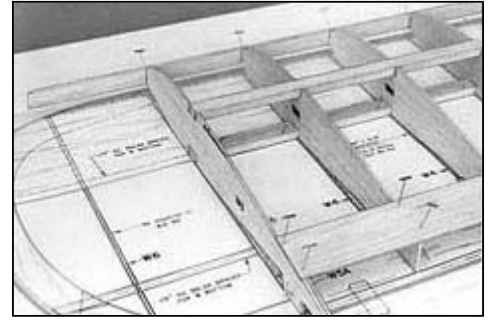

- n. Glue balsa rib W6 in place.

Let the entire wing panel dry thoroughly!

2. COMPLETING THE WING PANEL

- a. Unpin the wing panel from the board and cut off the jig tabs at the back of each rib. Cut from the front towards the die-cut slit at the back. Then use a sanding block to lightly touch up the ribs until they are all even.
- b. Glue on the 3/32"x1-1/4"x30" balsa trailing edge bottom sheeting. When dry sand sheets flush with the end of the ribs.
- c. Glue on the 1/4"x5/8"x30" balsa trailing edge piece.
- d. Trim and sand the 1/8"x9/16" balsa leading edge flush with the top and bottom of the ribs.
- e. Cut the 1/2" balsa wing filler block from the printed balsa sheet No.11. Glue it in place between ribs W1 and W2, behind the leading edge. When dry, carve and sand the top and bottom of the block flush with the ribs.

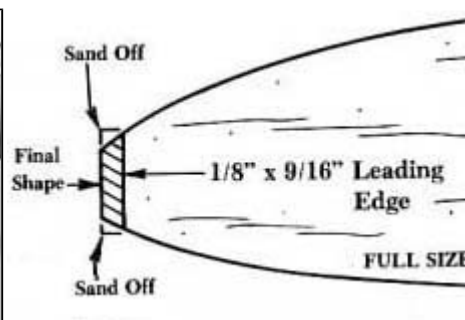

- f. Use the pattern to the right to cut the top and bottom front wingtip braces from 1/4" sq. balsa stock. Soak both braces in a bowl of water for 2-3 minutes to make them bendable, and then glue both in place at the same time. Glue and pin the square ends first, flush against the wing panel main spars. When those ends are secure, squeeze both angled ends together onto the tip bow and glue them securely. Also glue at rib W6.

PATTERN FOR 1/4" SQ. BALSA FRONT WINGTIP BRACES - TOP & BOTTOM
 Top and Bottom Braces are same overall length with slightly different angles at the tip end.

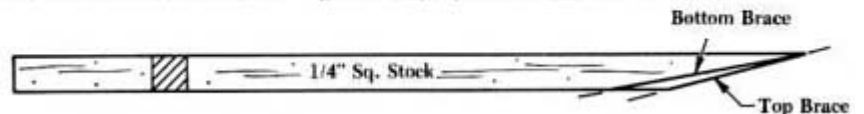

- g. Bevel the top and bottom balsa edges of the wingtip where the 3/32" leading edge sheeting will attach. Blend the bevel into the 1/4" sq. tip brace at the back and the shape of the leading edge at the front. Sand all the way down to the edge of the light-ply center at the tip bow.
- h. Glue on the 3/32"x4"x36" balsa top and bottom leading edge sheeting. Attach both sheets to the main spars, leading edge, and all the main wing ribs W1 through W5. Do not try to bend the ends of the sheets over W6 and the wingtip bow yet,
- i. Wet the ends of the top and bottom leading edge sheets with water to make them easier to bend over the wingtips. Let the water dry in a couple of minutes, then glue and pin the sheets securely to the wing tip structure. When dry, trim the excess sheeting off flush with the leading edge and the tip bow.

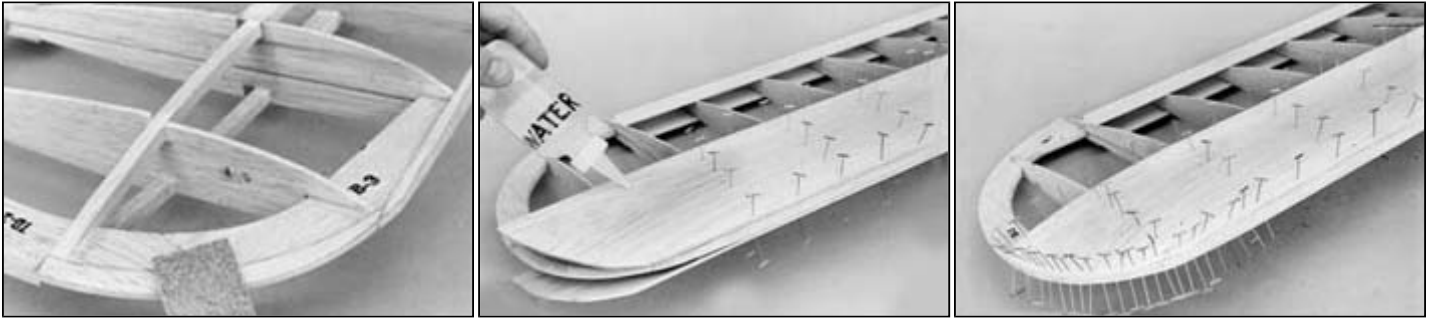

- j. Glue the 3/8"x3/4"x3/4" anchor block onto the grooved landing gear block. Note the anchor block should be offset 3/16" from the end. Drill a 5/32" dia. hole straight through the grooved block and the anchor block - see wing plan for exact location of the hole.

- k. Glue the grooved landing gear block assembly into the rib notches. It should stick out 3/32" so as to be flush with the balsa sheeting when it is added.

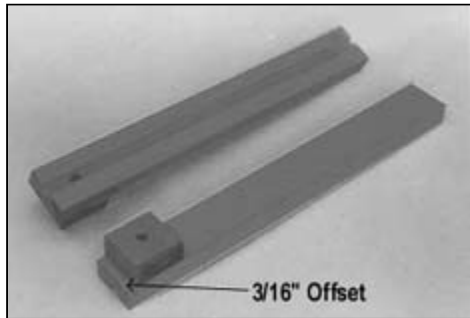

- l. Plank the bottom of the wing panel, from rib W1 out to rib W3, with 3/32" sheet balsa. Cut pieces to fit from the 3/32"x3"x36" balsa stock provided, and then glue the pieces in place.



- m. Plank the top of the wing panel, from rib W1 out to the last W2 rib, with 3/32"x3" sheet balsa in the same manner as you just did the bottom.

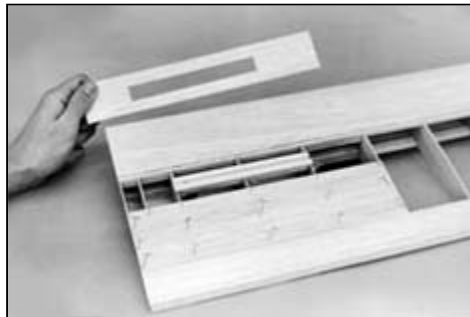

- n. Cut to length and glue all of the 3/32"x3/16" balsa capstrips for the top and bottom of the wing ribs. NOTE: Do not capstrip rib W6.



- o. Cut and install the 1/4" sq. top and bottom rear wingtip braces. Make these braces out of separate straight sections of wood, with a break at rib W6. Do not try to make them in one piece and bow them in place as you did the front tip braces.

- p. Glue the 3/16"x3/4"x36" leading edge cap. When dry, carve and sand the leading edge cap to finished airfoil contour.

- q. Carve and sand the 1/4"x5/8" balsa trailing edge piece (installed earlier, step 2c) flush with the trailing edge sheeting.

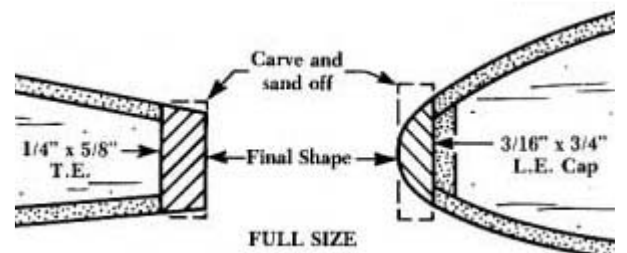

- r. Carve and sand the wingtip to final shape - except for the area near the end of rib W5 which must be blended into the aileron after it is attached.
- s. Carefully block sand the entire wing panel until all joints are smooth and even. Use a large sanding block to avoid sanding down any one area too much.



Now go back to step 1e and repeat the process up to this point to build the opposite wing panel.

3. JOINING THE WING PANELS

- a. Carefully block sand the center end of both wing panels until the sheeting, spars, leading edge and trailing edge are all flush with the pre-angled center rib W1. Use a large sanding block and sand slowly to keep the ends of the panels straight and true.
- b. Check the fit of the wing panels to each other by blocking them up together as shown below. When the center ribs are tightly together on the building board, each wingtip should be approximately 3-1/8" above the board. The 3-1/8" measurement is from the bottom of rib W5 to the board. The pre-angled W1 center ribs should automatically put the tips close to the correct measurement.



If your tips measure anywhere from 3" to 3-1/4" and the center ribs are fitting together nice and snug - that's close enough - don't try to alter the angle of the center ribs to get the tips exactly 3-1/8".

Being 1/8" off at the tips only changes the actual total dihedral angle 1/4", and that won't harm the model's flying characteristics at all.

It's more important to have the center ribs perfectly snug to each other, without any gaps, than it is to get the dihedral exactly 3-1/8". If you do have gaps between the center ribs, resand with the large sanding block until the fit is good.

- c. Cut a 3/32" wide slot in the W1 center rib of each wing panel to accept the die-cut plywood dihedral brace. The slot should be the full height of the rib, right at the front of the main spars. Use a good sharp modelling knife for making this cut to avoid splintering the rib.
- d. Trial fit the wing panels together again without glue, this time with the dihedral brace in place to make sure it doesn't interfere with the snug fit of the center ribs. Alter the slots if necessary.



e. Glue the right and left wing panels together, including the dihedral brace, with slow drying epoxy glue. First work glue into the slots with a dowel or wire to insure that the dihedral brace will get securely glued to the main wing spars inside. Then smear a coat of glue on both center ribs so that the joint between the wing panels will be completely filled. Finally, coat the dihedral brace with glue and slide the parts together. Carefully line up the leading and trailing edges so there is no twist between the panels. Pin securely and wipe off any excess glue that has oozed out of the joint. Block up the wing assembly as you did for checking the dihedral angle, double check the final alignment, and then let dry.

f. A pocket has been built into the center of the wing where the aileron servo will be mounted. The pocket is the space between pieces W1A, W1B, and the back of the spars. Carefully remove the 3/32" top wing sheeting flush with the sides of these pieces. Then use a small saw to remove the section of center ribs W1 that runs through the middle of the pocket. Do not cut into or remove any of the 3/32" bottom wing sheeting.



g. Cut both pieces of shaped balsa aileron stock to the length shown on the plans for the ailerons - 26-5/16" long. Save the cutoff ends of aileron stock for later use.

h. Draw a hinge center-line down the middle of the leading edge of both ailerons. Draw a corresponding hinge center-line along the middle of the wing trailing edge.

i. At one end of each aileron, mark the location for the aileron torque rod installation. Slot and drill the aileron leading edge to receive the torque rod wire and then epoxy them in. Don't get any glue on the brass bearings!

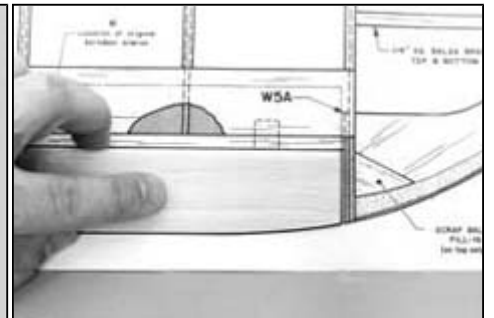
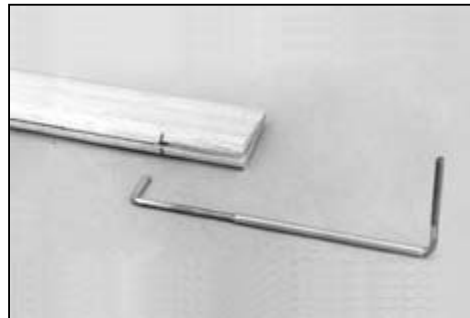

j. With a sanding block, curve the trailing edge of each aileron at the tip until it matches the plan.



k. Finish sanding the the ailerons to final shape with 220 grit sandpaper. It's not necessary to change the actual shape of the aileron much, just round off the corners of the leading and trailing edges and make the entire aileron smooth. Don't sand off the hinge center-line.

l. Cut the molded plastic hinges loose from their connecting spruce and pre-fix each one at the center by bending it back and forth several times. Cut slots in the aileron leading edge and the wing trailing edge to receive the hinges. Use 5 hinges per aileron as shown on the plan.

Do Not Glue The Hinges In Yet!

m. Dry fit the ailerons onto the wing without any glue on the hinges. Check the movement of the aileron up and down. If there is any binding or misalignment, alter the hinge slots if necessary to correct. Keep in mind that the gap between the aileron and the wing should be kept as narrow as possible (about 1/32" to 1/16" maximum). The aileron should be able to travel about 1/2" up and 1/2" down. If you need a bigger gap than that to get much movement, you may have to round the leading edge of the aileron a little more.

An X-Acto #11 knife blade or a Goldberg or Du-Bro hinge slotting "fork" are the handiest tools to use for cutting the initial hinge slots. Then clean out the slots by working an X-Acto #15 saw blade in and out of the slot repeatedly until just enough wood has been removed to allow the hinge to slide easily.

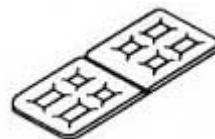

NOTES ON MAKING HINGE SLOTS



- n. Epoxy the hinges in permanently. Working with one aileron at a time, fill all 5 hinge slots in the aileron with slow drying epoxy glue. Insert the hinges halfway into the slots. Wipe off any excess glue that oozes out of the slot. Set aside and epoxy five hinges into the slots in the other aileron. Let both ailerons dry completely! Repeat the process to glue the other end of the hinges into the slots in the wing trailing edge. Make sure to wipe off all excess glue in the hinge gap. Let dry.

- o. Epoxy the torque rod bearings to the trailing edge of the wing. The brass tube bearings might not actually touch the back of the wing depending upon how wide your hinge gap is. Do not force the bearing against the trailing edge when gluing! Let it adopt whatever natural position it takes from the lineup of the aileron and surrounding it with glue, allowing the glue to fill any gap. Be careful not to get any glue on the wires.

COVERING NOTE:
If you are going to cover your Astro-Hog with an iron-on pre-colored covering material (like Monokote, etc.), it is best to cover the ailerons and wing trailing edge at this time before proceeding to the next step.



- p. Glue the 1/16" die-cut plywood wing bolt supports in place on the bottom of the wing. They should extend approximately 1-9/16" past the wing to line up with the trailing edge of the ailerons. From the rear view, the ply bolt supports should line up just under the bottom surface of the ailerons when the ailerons are held in neutral position.

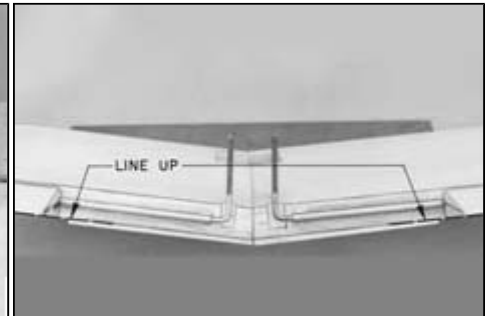
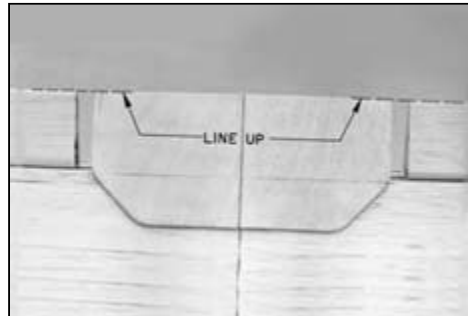

- q. Cut two pieces of leftover aileron stock to fill in the area between the ailerons. Notch the front of the pieces to fit over the torque rods. Glue in place, being careful not to get any glue on the torque rods where it could bind them up.

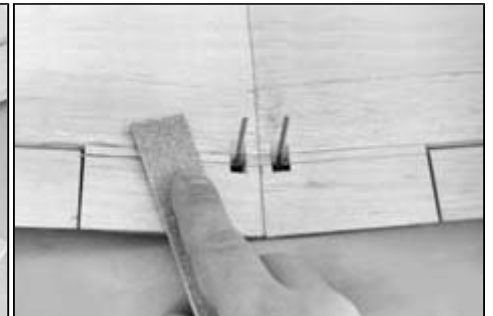
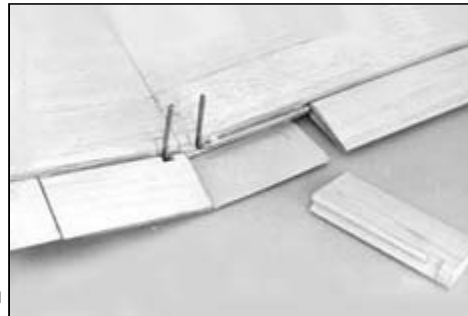

- r. Fill in the gaps between the aileron stock and the wing trailing edge with scrap balsa. When dry, sand the filled in area to final wing contour.

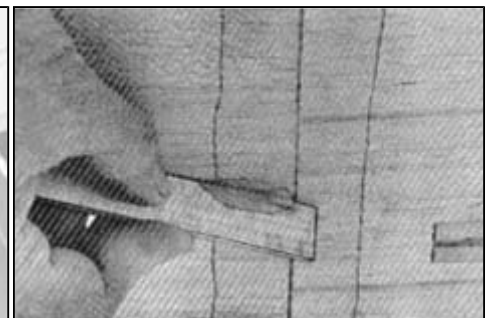

- s. Pin the ailerons in neutral position and finish shaping the wing tips at the back of rib W5. Make the tips blend smoothly into the ailerons.

- t. Cut strips of 2" fiberglass tape to reinforce the wing center joint. Cut 3 pieces for the top of the wing and 1 piece for the bottom.

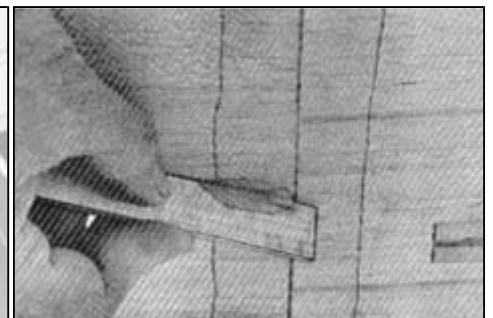

To Apply the Fiberglass Tape

1. Coat the wing center with slow drying epoxy glue.
2. Lay the tape on top of the glue.
3. Holding one end of the tape so it won't slip, "squeegee" the glue through the tape with a small paddle of scrap balsa. Scrape over the tape several times with the squeegee paddle to smooth the tape and remove excess glue.
4. When dry, sand lightly to remove any rough spots. Try not to sand into the fiberglass tape itself.

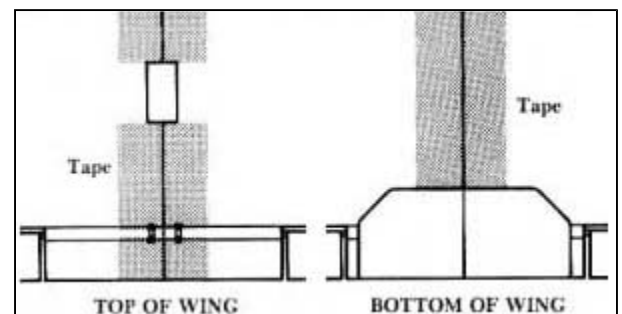

4. FUSELAGE SIDES

Cover the building board with wax paper. Pin printed balsa sheets No.7 and No.8 - the right and left fuselage sides - onto the board.

- With a modelling knife, cut loose from the rest of the printed sheet the small parts that are printed under the wing saddle area of each fuselage side. The part is marked A and B for the right fuselage side, X and Y for the left fuselage side. Save these parts to be used later.
- Cut to length and glue onto the fuselage sides all of the 1/4"sq. balsa corner stringers and vertical pieces. Be sure to leave a 1/8" gap in the corner stringers where formers F2 and F5 will go.
- Glue and pin balsa doublers FSD on the fuselage sides. Be very careful to achieve good alignment of FSD with the printed lines on the fuselage sides, as FSD will set the stabilizer at the correct incidence later.
- Glue lite-ply doublers LPD-1, LPD-2 and LPD-3 in place. Note the gaps between the doublers for formers F2 and F5. Use epoxy glue, not Sig-Bond or any other water base glue (the water can cause these parts to curl).

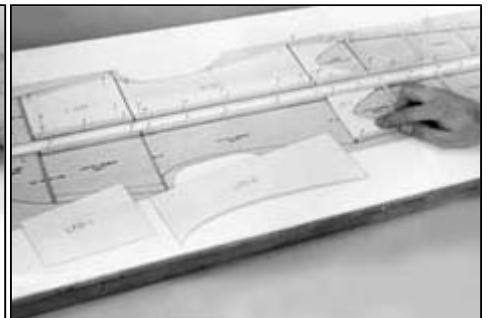
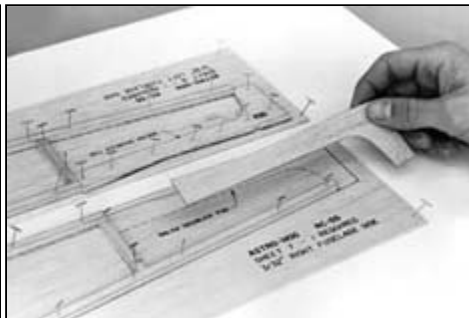
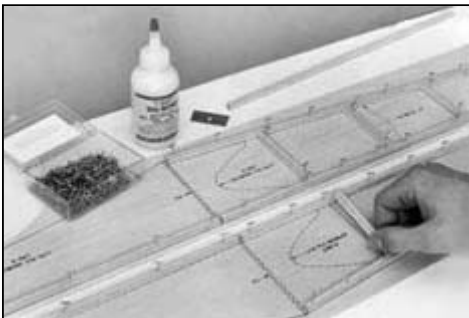
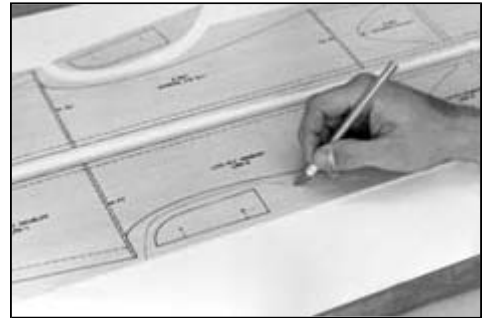

- Cut to length and glue in place the 1/2" balsa triangles that go along the front and bottom edges of doubler LPD-1.
- Trim completely around the outside edge of each fuselage side with a shap modeling knife, cutting away the excess printed sheet. Where structure has already been glued on, trim the excess away flush with the structure. At the front trim to the printed outline.
- Cross-match the fuselage sides by pinning them together and using a sanding block to true-up any rough edges. If the sides were built and cut accurately, not much sanding will be needed. Be careful when sanding in the wing saddle and stabilizer mount areas not to change the incidence angles.
- Finish cutting out the two small A-B and X-Y parts that were set aside in step 4a. Then glue them in place on the fuselage sides, pinning flat until dry. The corresponding letters on the sides will help align the parts correctly. Use a piece of waxed paper or plastic wrap underneath the glue seam to keep it from sticking to the board.

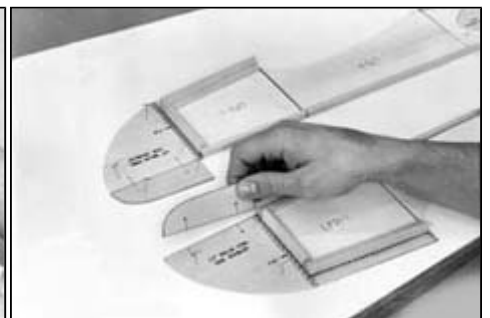
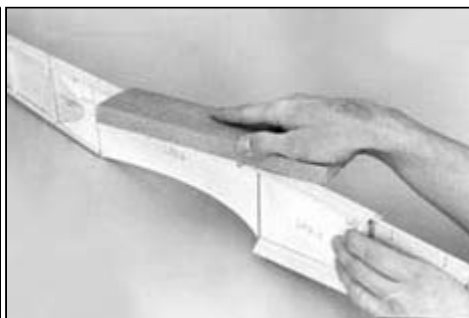
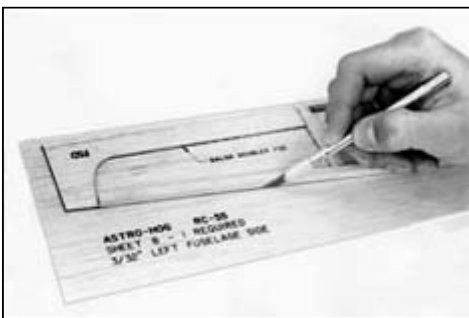

5. FIREWALL ASSEMBLY

NOTE: You need to have the engine and muffler that you will be using on hand when working on the firewall.

a. Epoxy the die-cut plywood firewall parts F1A and F1B together. Hold or clamp together until dry.

b. Mark the vertical center-line and thrust line on the front of the firewall, using the F-1 cross-section drawing on the plan as a guide. Check the width of the engine that you intend to use and determine the spacing that will be required between the aluminum engine mounts. Now locate the mounts on the firewall accordingly. Mark the locations of the four mounting holes and drill them out with a 3/16" drill bit.

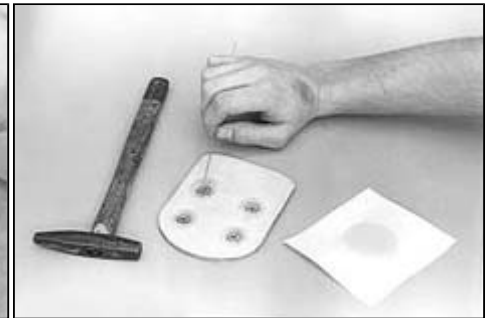
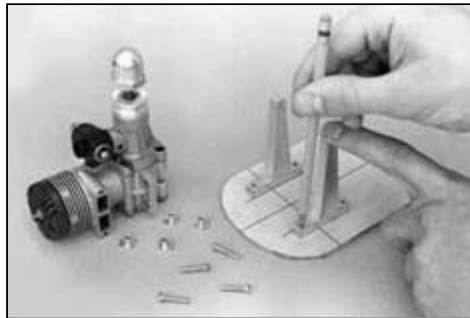

c. Bolt the engine mounts loosely onto the firewall with the 5-32" mounting bolts and blind nuts provided. Double check to see that the mounts are lined up properly and then start tightening up the bolts. Keep tightening until the prongs of the blind nuts are started into the wood and holding. Now carefully remove the mounts and bolts from the firewall and tap the blind nuts the rest of the way into the wood with a hammer. Spread epoxy glue over the blind nuts to keep them firmly in place. Be careful not to get any glue in the threads of the blind nuts.

d. Draw a line across the back of the firewall representing the bottom of die-cut balsa former F1C. Use the F-1 cross-section drawing on the plan as a guide. Now trim out the bottom of former F1C where necessary to clear the blind nuts. Then glue F1C in place.

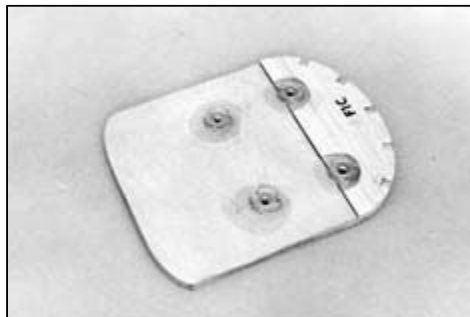

e. Hold (or tack glue) the firewall in position on one of the fuselage sides. Slide your engine back and forth on the mounts until the engine's thrust washer sticks out 1/4" to 1/2" ahead of the fuselage side. Mark the engine mounting holes on the aluminum mounts. Drill the holes with a #36 drill bit and tap for 6-32 mounting bolts. (See below)

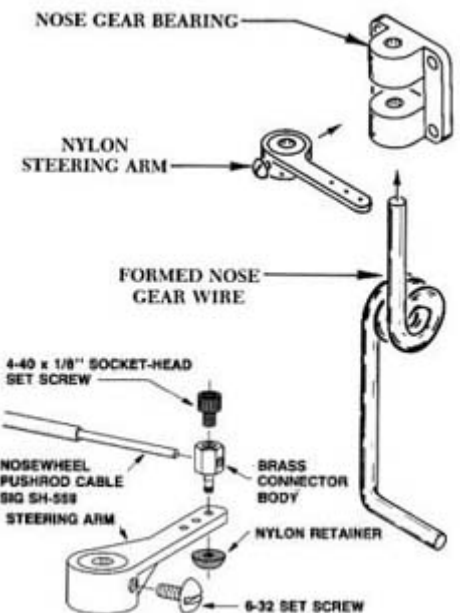

TAPPING ALUMINUM ENGINE MOUNTS

Clamp the engine mount securely in a vise and center punch the motor mounting holes. Drill the holes with a sharp twist drill bit in a variable speed electric drill. If possible, use a drill press instead of a hand held drill. Lubricate the drill bit with machinist's cutting oil, special aluminum tapping fluid, or other light household oil such as Marvel or 3-in-1.



Run the drill at a moderate speed with moderate pressure. Let the bit cut its way through the aluminum at its own rate. Don't try to force it with excess pressure or high speed. Aluminum galls easily and may jam and break the bit if forced. If resistance builds up, back it out of the hole frequently and clean off the metal fragments. Relubricate the bit and hole with oil and continue drilling. Tapping the drilled holes is easy if the same precautions are taken. Lubricate the tap liberally with cutting oil. Use moderate constant pressure when turning the tap into the hole. If resistance builds up, back the tap back out frequently and clean the fragments out of the threads. Use plenty of oil and work slowly.

- f. Position the nylon nose gear bearing on the front of the firewall and mark the mounting hole locations. Drill out the holes with a 9/64" bit and install 4-40 blind nuts and mounting bolts- in the same manner you did for the engine mounts in step 5c.
- g. Assemble the nylon steering arm and formed nose gear wire into the nose gear bearing on the firewall. Check it turns freely.
- h. A hole must be drilled through the firewall at this time for the flexible cable pushrod that will operate the nose gear steering. First check these instructions further on and familiarise yourself with pushrod installation. Then fasten the supplied pushrod connector into the middle hole of the nylon steering arm. Turn the steering arm back against the firewall and mark the spot for the pushrod to exit and hit the connector. Drill with a 3/16" drill bit.
- i. Locate the best spot on the firewall for the throttle pushrod to exit and line up with your engine's carburetor control arm. Drill the hole with a 3/16" drill bit. Avoid placing the hole within 1/2" of the firewall edge. A 1/2" balsa cowl side doubler will occupy that space later.
- j. Cut a 7/8" dia. hole in the firewall for the tubes from the fuel tank to stick through. See section 14 "Tips On Tanks" for some recommendations for fuel tank selection. If you use a standard-style 12oz round or rectangular tank, as recommended, place the center of the hole 1/2" above the thrust line. If you elect to use a slant-style tank or a tank smaller than 12oz., you may want the hole a little higher. Plan your tank installation now!

A jig saw works best for cutting out the hole. Or, you can drill a series of smaller holes around the perimeter of the 7/8" hole, and then cut between the small holes with a keyhole saw blade (such as X-Acto #27).

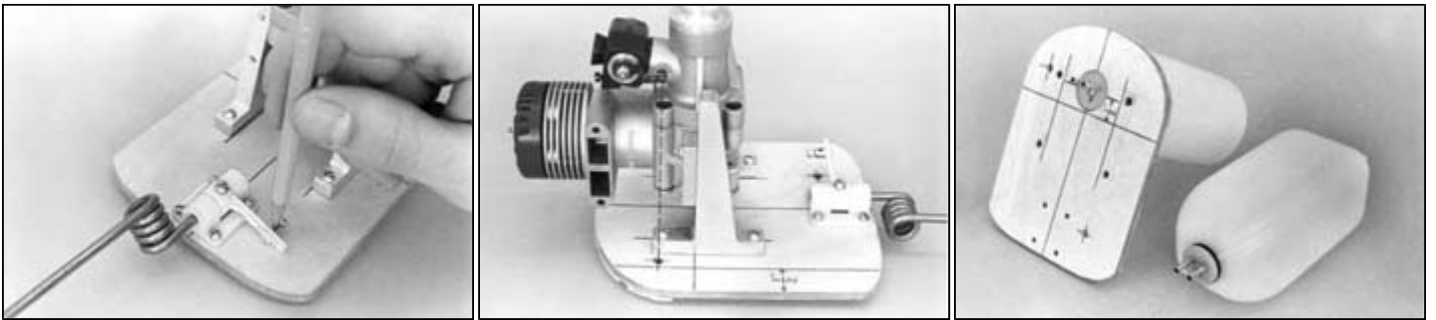

6. JOINING THE FUSELAGE SIDES

- a. With a sanding block, bevel the rear ends of the fuselage sides as shown. Sand until the tail end of each fuselage side is 1/8" thick.
- b. Glue the firewall in place on the left fuselage side. Use 5-minute epoxy and hold it square against a 90 deg. triangle until dry. **IMPORTANT NOTE:** The bottom lip of former F1C should seat tightly against the top of the 1/4" sq. fuselage corner stringer.
- c. Epoxy die-cut plywood formers F2 and F5 in place on the left fuselage side. Glue them on one at a time with 5 minute epoxy and use a 90 deg. triangle to hold them square until dry.

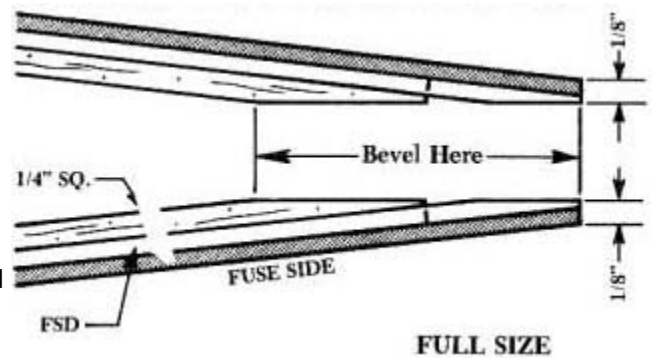

IMPORTANT NOTE: Both F2 and F5 have small die-cut slits on their sides which should line-up with the top of the 1/4" sq. fuselage corner stringer.

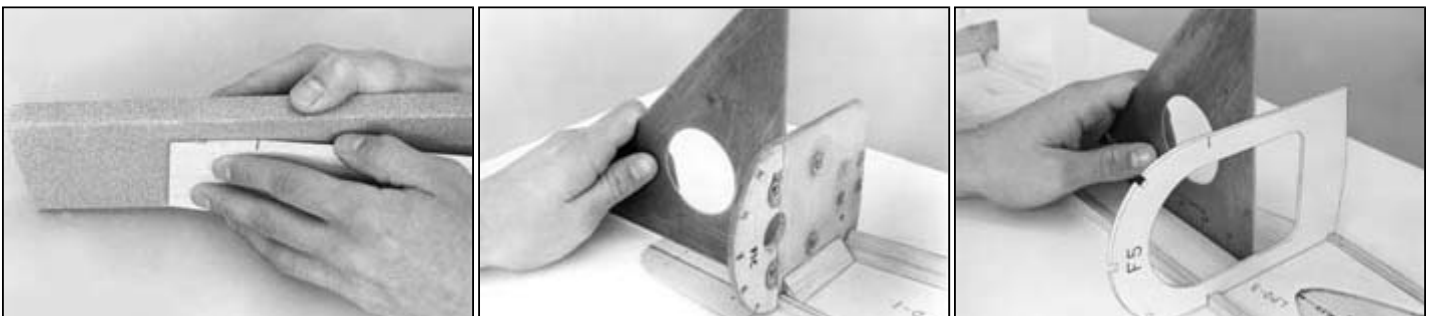

- d. Epoxy the right fuselage side onto the formers and firewall. Use slow drying glue and lots of pins so that you have plenty of time for getting an accurate alignment of the fuselage sides to each other and to the formers before the glue dries. Make sure that the tail ends of the sides line up properly. Let dry.
- e. Glue the die-cut balsa formers F3, F4, and F5A in place. Space them out carefully between F2 and F5. The exact distances between the formers are shown on the side view plan.
- f. Cut to length and glue in place the 3/16" sq. balsa top stringers that go between formers F1C and F5A.
- g. Sand down the edges of the die-cut lite-ply cockpit floor until it fits between the two stringers that bridge across the sides of formers F3 and F4. Glue the floor in place.
- h. Align the fuselage on the top view plan, pinning the bottom of F2 and F5 to the building board. Pull the tail ends of the fuselage sides together and glue. Make sure that the joint is directly over the centerline on the plan. Let dry.

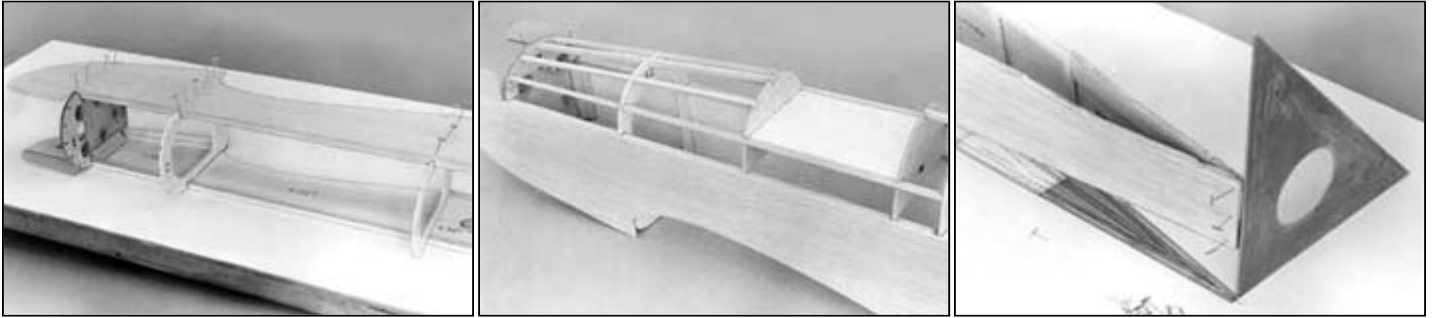

- i. Glue in die-cut plywood formers F6, F7, F8A, and F9A. Check side view plan for exact positioning in relation to the 1/4" sq. balsa uprights in the fuselage sides.
- j. Glue the die-cut plywood formers F8B and F9B. The bottom corners of these formers should be flush with the 1/4" sq. corner stringers.
- k. Cut to length and glue in place the 3/16" sq. bottom middle stringer that runs from the back of former F5 to the tail end of the fuselage.
- l. Cut four short pieces of 1/4"x1/2" balsa stick to use as cross braces behind former F5. Sand them to fit between the corner and middle stringers and then glue in place.



- m. Using a long straightedge and a modeling knife, cut a 3/32"x3"x36" balsa sheet diagonally from corner to corner.

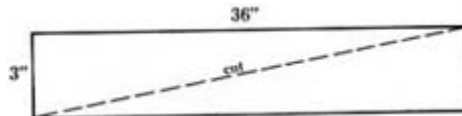

Glue and pin the two tapered pieces onto the bottom of the fuselage. When dry, trim off the excess flush with the fuselage sides.

- n. Cut to length and glue in place the three 3/16" sq. balsa top stringers that run from former F5 back to former F9A.

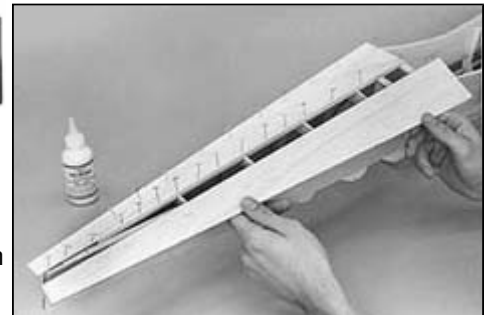

7. FINISHING THE FUSELAGE

- a. Trial fit your fuel tank in the fuselage. Slip a 3/16"sq.x2-1/8" balsa stick (cut from scrap) between the top of the tank and the bottom of the fuselage top stringers. Slide the stick backward or forward until the tank sits level in relation to the top fuselage sides. Glue the stick to the stringers after you find the right spot.

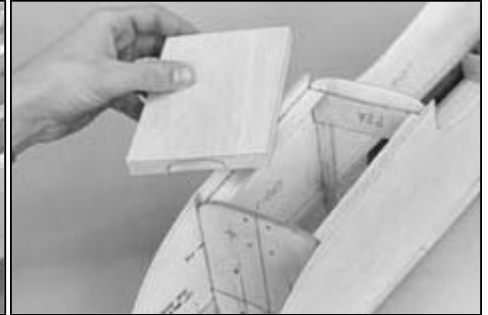
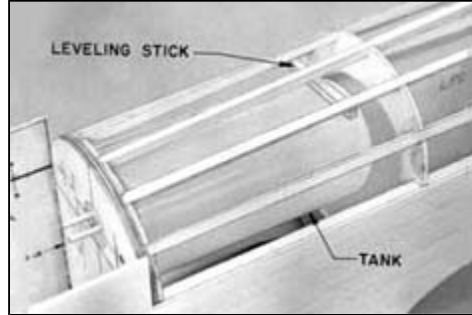

- b. Glue die-cut plywood former F2A in place.
- c. Use a sanding block to bevel the ends of the 1/2"x4-3/16"x6" nose bottom block until it fits in place. Recess a small area on the front of the block to clear the nose gear blind nuts. Then glue the block in place. Don't get any glue in the threads of the blind nuts.
- d. Two pieces of 3/32"x4"x36" balsa are supplied for sheeting over the top of the fuselage formers. Use the paper patterns provided to cut the sheeting stock into 4 separate pieces - 2 for covering the front formers (F2 through F5A), and 2 for covering the rear formers (F5 through F9A). You'll find that the paper patterns are approximate only and slightly oversize to allow for minor variations between models. Slight trimming of the balsa sheets may be necessary to make them fit your airplane perfectly.

- e. Glue both the front sheeting pieces, along their bottom edges only, to the fuselage sides. Once these joints are dry, wet the outside surface of the sheets to make them easier to bend. Trial bend the left sheet down onto the formers to check the fit. Carefully retrim where necessary. Note that the top seam should overlap halfway onto the 3/16" sq. top stringer. When satisfied with the fit, apply Sig-Bond glue to the formers and stringers, and start pinning the left sheet securely in place. Finish trimming any rough edges after the sheet is pinned down. Repeat the bending, gluing, and pinning process for the right side sheet, joining it to the left sheet at the top stringer.

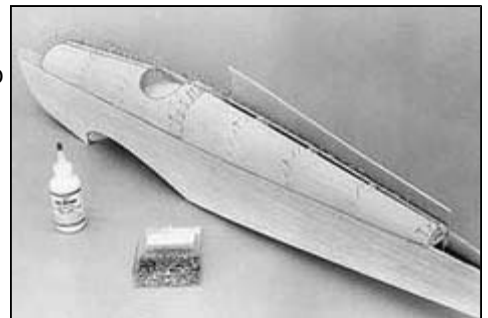

- f. Attach the two rear 3/32" balsa sheeting pieces in the same manner you just did the front piece.
- g. Cut out the 1/2" balsa cowl side doublers from printed balsa sheet No.11. Glue the doublers in place.

- h. Sand the sides of the 5/8"x3-3/16"x4-1/2" balsa cowl bottom block until it fits between the cowl side doublers. Bevel the back end of the block to fit flush against the firewall. Shape the side view of the block to match the contour of the fuselage sides.

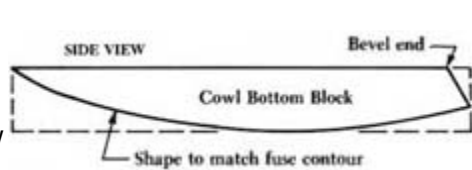

- i. Make an oval cutout at the back end of the block to clear the nose gear assembly. Hollow out the inside of the block enough to allow adequate movement of the steering arm. Glue the block in place.
- j. A 6" long piece of balsa triangle stock is supplied. Cut it in half and glue the two pieces in the front corners of the cowl. Cut and sand the excess off flush with the fuselage sides.
- k. Add the 3/4"x1"x3-1/4" balsa filler block that goes along the top of the firewall, between the cowl side doublers. Cut the block to the shape shown on the top view plan before gluing it in.
- l. Carve and sand all the wood in the top cowl area down flush with the fuse top sheeting
- m. Carve and sand the 1/2" balsa bottom block down flush with the bottom of formers F1 and F2.

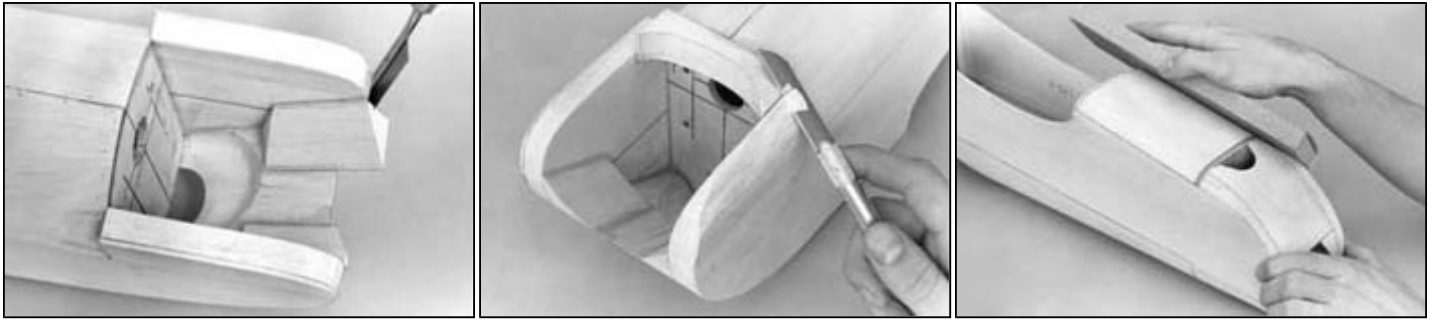

- n. Carve and sand the remaining front corners of the nose to blend smoothly into the top and bottom contours.
- o. Shape the 1" balsa triangles and the inside of the top filler block to a pleasing contour. 80 grit sandpaper wrapped around a large diameter dowel is handy for this job.
- p. Carefully sand the remainder of the fuselage to final form. Round the bottom corners of the rear fuselage as shown in the cross-section drawings on the plan.

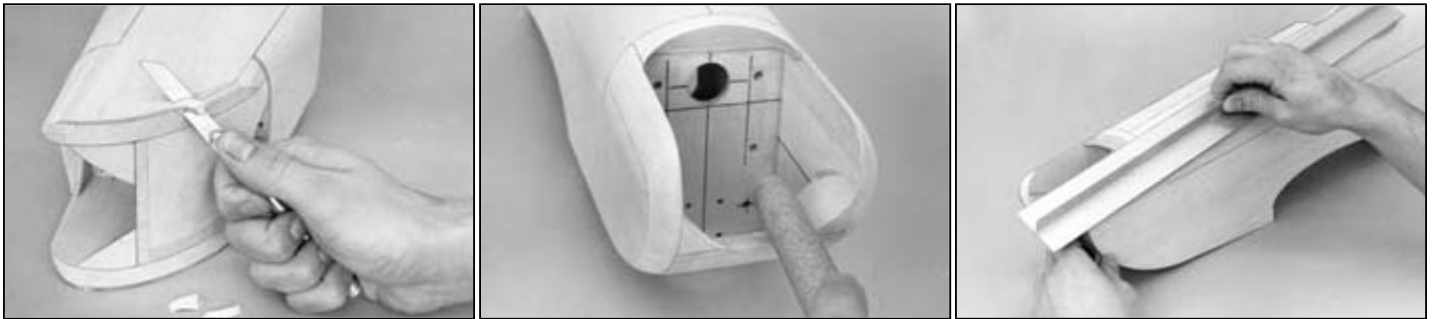

8. COCKPIT AND PLASTIC HEADREST

Trim the cockpit opening to finished size using the full size pattern provided with the plan as a template. Trim with a sharp knife and finish the edge with fine sandpaper.

Sand the outside of the headrest with 360 grit or finer sandpaper to remove the surface gloss of the plastic. Do not use coarser sandpaper which will put deep scratches in the plastic. Deep scratches will often open up wider during painting and become prominent. Shape the bottom edges of the headrest with an 80 grit sanding block until it fits evenly onto the top of the fuselage.



If you are planning to paint your entire model, glue the headrest in place now and paint it later when you do the rest of the model. Glue it with Sig-Ment, Sig Epoxy, or cyanacrylate "super" glue.

If you are planning to use an iron-on pre-colored covering, paint the headrest separately and glue it in place after the fuselage has been covered. Peel off the iron-on covering where the headrest will sit so that it can be glued directly to the balsa.

CAUTION: Do not try to cover the ABS plastic headrest with Monokote or other iron-on types of covering material. The heat may melt and distort the plastic.

We recommend that the headrest be painted with Sig Supercoat Dope or Sig Skybrite paint for best results. Hobbypoxy, K&B Superpoxy, and Dulux (automotive) enamel have also been proven compatible with ABS plastic and can be used if desired. Do not use other paints, dopes, or finishes without testing to make certain it is compatible with the plastic.

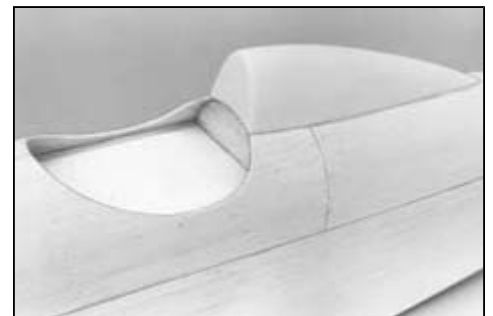

Color paint can be put directly on the sanded headrest. Primer type coats are not needed if a good sanding job was done with fine sandpaper. The color paint can be brushed or sprayed onto the headrest. Try not to apply heavy, wet coats which may cause an "orange peel" effect. Put on light coats with adequate drying time between coats. Follow the paint manufacturer's instructions carefully.

9. MATING THE FUSELAGE TO THE WING

- Set the fuselage on the wing to check the fit. If necessary, lightly sand the wing saddle area of the fuselage to achieve a good fit with no large gaps.
- Carefully drill two 1/4" dia. holes through former F2 for the wing dowels. The exact locations for the holes are premarked on F2 by two small dimples.
- Cut the 1/4" dia.x6-1/2" long hardwood dowel supplied into three pieces - one 4" long elevator joiner, and two 1-1/4" long wing dowels.
- Grind or sand one end of both 1/4"x1-1/4" wing dowels to a sharp point - keep the point symmetrical and centered. Push the dowels into the holes in F2, leaving just the sharp points sticking out. (It may seem that the dowels go into the holes awfully hard at first, but they will loosen up after they've been pushed in and out a few times.)
- Carefully slide the wing into position, pushing the sharp dowel points into the wing leading edge.



- Remove the wing and drill two 1/4" dia. holes through the wing leading edge where indicated by the dowel punch marks.
- Remove the wing dowels from former F2. Put a piece of wax paper over the face of F2 and then reinsert the dowels through the paper back into F2. Push the dowels only 5/16" into F2 this time - leave most of the dowel length sticking out.

- Trial fit the wing in position, sliding it into the dowels. Check to see that the wing still fits the fuselage. If not, slowly enlarge the holes in the wing leading edge until it fits properly. When satisfied with the fit, coat the inside of the holes in the wing with epoxy glue. Put the wing back in place and hold securely in position until the glue dries. When dry, carefully remove the wing, pulling the dowels out of F2. Fill any small gaps around the dowels at the wing leading edge with another application of glue.

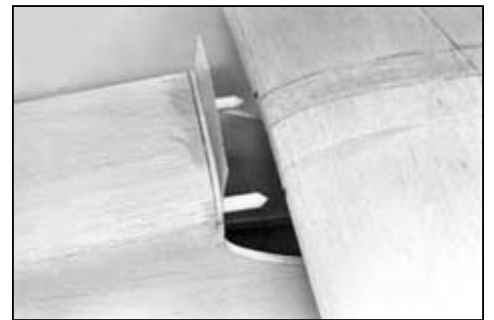

- The 3/4"x3/4"x1-1/2" hardwood wing bolt blocks must be shaped to fit properly in the fuselage. Bevel one end of each block by drawing a line on it matching this pattern, and then sanding to the line. This beveled end fits snugly against former F5 when the side of the block is lined up with the wing saddle.

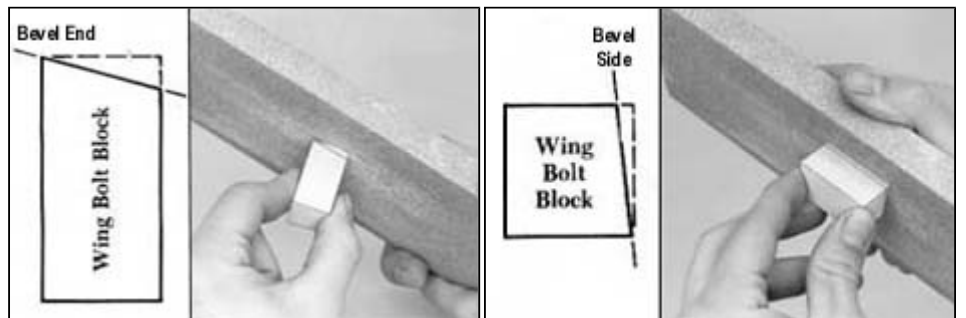

Bevel the side of each block next. Draw a line on the block matching this pattern and sand to the line. This beveled side should fit snugly against the fuselage side when the end of the block matches the dihedral angle (indicated by the bottom seam of former F5). Be sure to make a right and left block.

After shaping epoxy the blocks in place

- j. Reinforce the wing bolt blocks with pieces of 3/4" balsa triangular stock, cut from the 6" long piece provided.
- k. Tape or pin the wing in correct alignment on the fuselage. Determine the correct spots on the bottom of the wing and drill through and hit the hardwood wing bolt blocks in the desired locations for the nylon bolts. Drill through the wing and the hardwood blocks at the same time with a No.7 drill. (Remember to keep the drill perpendicular to the bottom surface of the wing so the heads of the nylon bolts will seat flush against the wing.
- l. Take the wing off and tap the hardwood blocks with a 1/4-20 tap. Redrill the holes to 1/4" dia. to pass the nylon bolts.

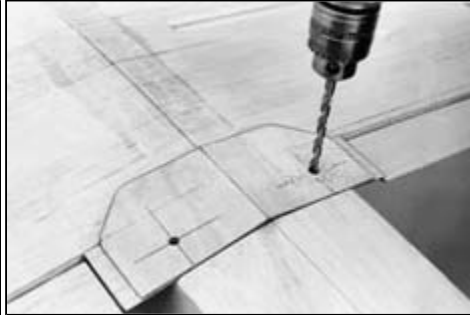
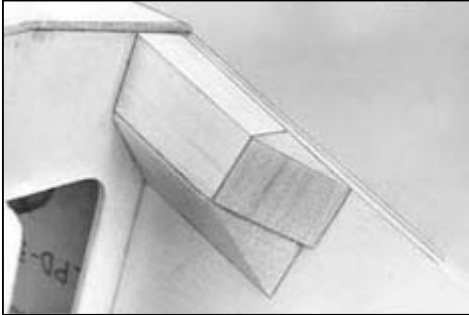
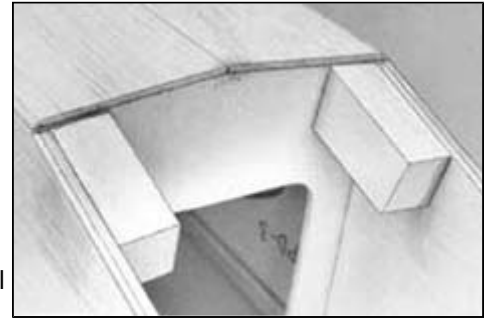

- m. Two pieces of 3/4"x2-1/2"x2" balsa are provided for making a fairing behind former F2 on the bottom of the wing. Bolt the wing in place on the fuselage and shape each block to fit down into half of the cavity.
- n. Carve the blocks roughly to shape so that the contour of the fuselage is carried onto the wing.
- o. Glue the blocks onto the wing, not to F2. When dry, finish sanding them to shape. Fill any remaining gaps with model putty or wood filler(*) to complete the fairing.

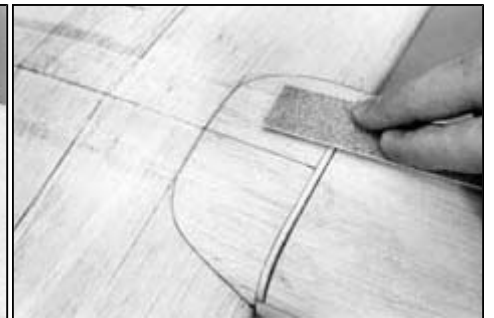
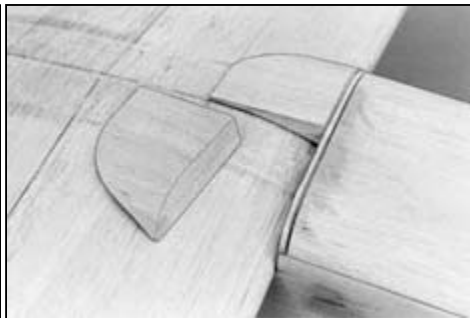
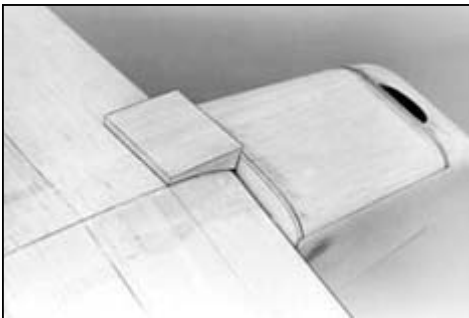

10. STABILIZER AND ELEVATORS

Pin the stabilizer/elevator plan to the building board and cover it with wax paper.

- a. Cut to length and pin on the plan the 5/16" sq. balsa stabilizer trailing edge.
- b. Glue the die-cut 1/8" lite-ply doubler against the front of the trailing edge.
- c. Cut the S-2 parts from the printed balsa sheet No.10. Glue and pin them in place against the trailing edge.
- d. Cut to length and pin in place the 5/16" sq. spruce leading edges. Add a short doubler, also cut from the 5/16" sq. spruce stock, behind the leading edge center joint.
- e. Cut to length and glue in all the 3/16"x5/16" balsa strip ribs.

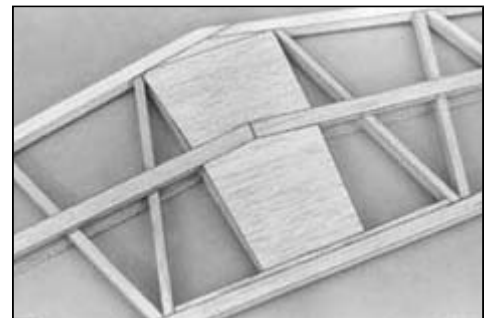

- f. Cut two pieces of 3/16"x3/8" balsa for the top spars. Glue in place on top of the strip ribs and S-2 pieces. Let the entire stab assembly dry completely before proceeding!
- g. When dry, unpin the stabilizer from the board and glue in the two die-cut balsa S1 ribs. Make sure the ribs are centered on the leading and trailing edges so that the 3/32" balsa sheeting to be added later will be flush.
- h. Cut to length and glue two 3/16"x3/8" balsa spars onto the bottom of the stabilizer.
- i. Add the 3/32" sheet balsa fill-in to the top and bottom of the stabilizer center-sections. Notice that at the front, the fill-in sheets butt up against the back of the 5/16" leading edge doubler, they don't overlap it.
- j. When dry, sand the point off the front of the stabilizer. Make the flat spot as wide as shown on the plan.
- k. Taper the tip ends of the top and bottom spars down to the edge of the S-2 pieces.
- l. Mark a center-line all the way around the outside of the stabilizer. Using the line as a guide, carve and sand the stabilizer leading edge, trailing edge, and tips round.

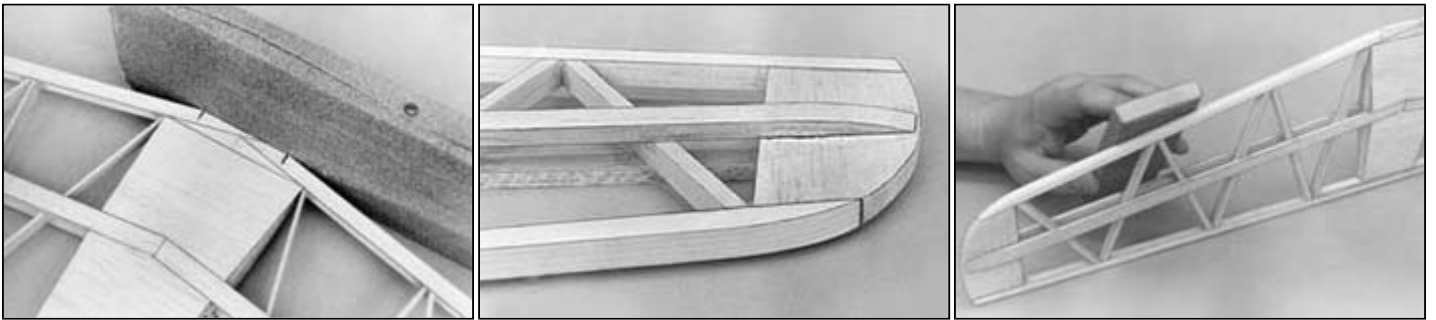

- m. Sand the 3/32" center-section sheeting smooth. You will note a slight mismatch where the sheeting meets the leading and trailing edges. Fill in these small voids with wood filler or model putty(*). DO NOT try to sand the voids completely out instead of filling them in, or you may sand down the leading and trailing edges too much and weaken them.
- n. Two 13-1/2" long pieces of 1/4"x3" balsa tapered stock are provided for making the elevators. Cut one of the elevator patterns from the plan and trace the outline onto both pieces of tapered stock. Cut the elevators to shape. IMPORTANT: Notice that one side of the tapered stock feels slightly rough while the other side is presanded smooth - plan your cutting of the left and right elevators so that the smooth side is used as the bottom for both.
- o. Join the elevators together by gluing them to the 1/4"x4" hardwood dowel joiner. Pin straight and flat on the building board until dry.

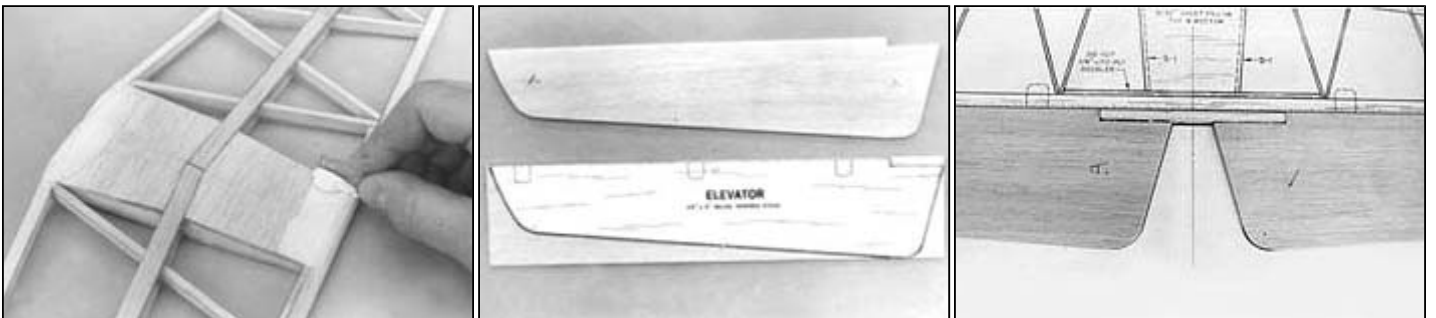

- p. Block sand the rough side of the elevators flat and smooth. Sand carefully so that the 1/4" leading edge thickness is maintained.

OPTIONAL: When block sanding (to the right), steepen the taper a little bit near the tip of the elevator to make the trailing edge a constant thickness along the back. This sounds tricky, but actually won't take more than a few passes of the 80 grit sanding block.

- q. Sand all the edges of the elevator assembly round. Hold the elevators up to the stabilizer trailing edge to blend the shape of the tips together.

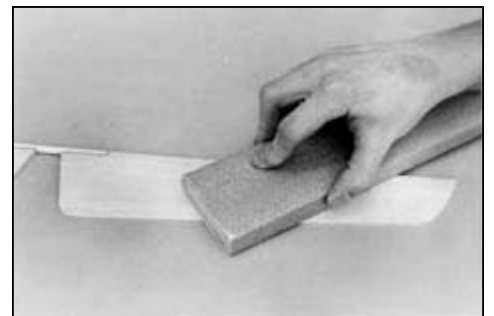

COVERING NOTE: Whether you intend to use a dope-on covering material or an iron-on pre-colored covering, it is best to cover the stabilizer and elevators at this time, before proceeding to the next step.

- r. Hinge the elevators to the stabilizer by installing 6 molded plastic hinges where shown on the plan. Use the same basic procedure you did for installing the aileron hinges.

11. FIN AND RUDDER

- a. Cut out the fin parts FN-1, FN-2, and FN-3 from the printed balsa sheet No.9. Glue the parts together using the connecting key letters (A,B,C) for alignment. Pin down flat on the building board until dry.

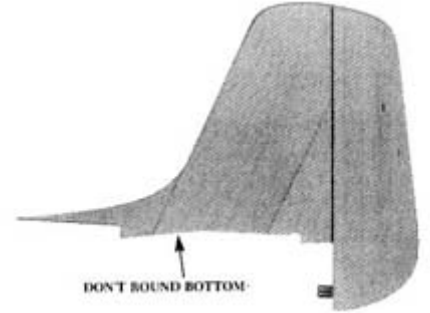
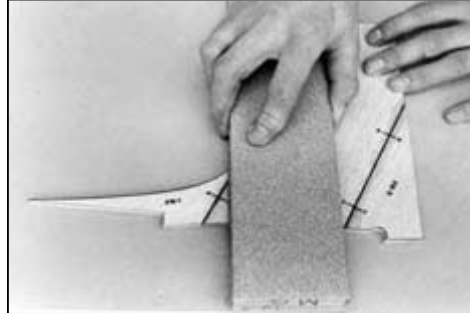

- b. Sand both sides of the fin smooth with a sanding block, removing the printed ink lines in the process.

- c. Sand the leading, trailing, and top edges of the fin round. Do not round the bottom of the fin where it will be glued onto the fuselage and stabilizer.

- d. A piece of 1/4"x3"x10-1/2" balsa tapered stock is provided for making the rudder. Cut the tapered stock to match the rudder pattern on the plan. Finish shaping the rudder by sanding all the edges round.

COVERING NOTE: If you intend to use or an iron-on pre-colored covering material, it is best to cover the fin and rudder at this time, before proceeding to the next step.

- e. Hinge the rudder to the fin by inserting 4 molded plastic hinges where shown on the plan. Use the same basic procedure you did for installing the aileron hinges.

12. ATTACHING THE TAIL SURFACES

- a. Bolt the wing on the fuselage and pin (don't glue) the stabilizer/elevator assembly in place. Carefully check the alignment of the stabilizer with the wing from the top view. Measure from the back of the wing to the stabilizer hinge line on both sides.

Also check the alignment of the stabilizer with the wing from the front view.

When properly aligned, use a pencil to draw the exact location of the fuselage on the bottom of the stabilizer center section. Unpin the stabilizer and remove it from the fuselage.

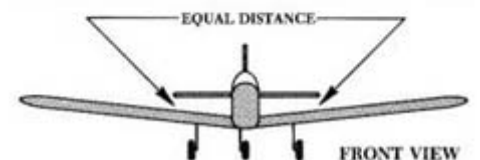
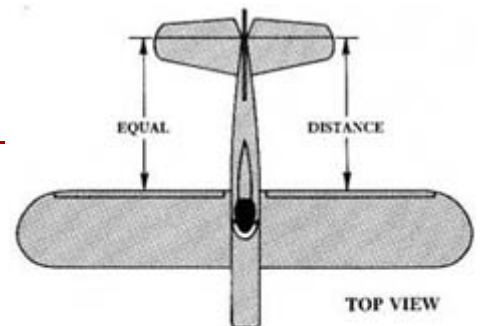

- b. If you've precovered the stabilizer as recommended, remove the covering material from the marked area to insure a good wood-to-wood glue joint with the fuselage. Apply slow drying epoxy glue and pin the stabilizer back in position. Recheck the alignment again and adjust the stabilizer position if necessary. Pin securely and let dry!

- c. Epoxy the hinged fin/rudder assembly in place, installing the bottom hinge into the rear of the fuselage at the same time. Align carefully, making sure the fin is perpendicular to the stabilizer. Let dry!



- d. Cut the tail fairing blocks from the printed balsa sheet No.11. Shape the blocks to fit each side of the fin. Glue in place.

13. RADIO INSTALLATION

It's easiest to mount all your radio equipment(*) and pushrods in the Astro-Hog before covering and painting. Once the initial installation has been made and all the bugs are worked out, you can take the radio system back out while the painting is being done.

Always double check all control hookups! Locate the source of any bending, rubbing, or sticking & eliminate it.

Mounting Servos(*) in the Fuselage

The most convenient method of installing the elevator, rudder, and throttle servos in the fuselage is on plastic trays(*) that are offered by most radio manufacturers for the equipment. These plastic trays are screwed to hardwood mounting rails(*) that are epoxied across the inside of the fuselage. We recommend that the hardwood rails be made of at least 3/8"sq. or 3/8"x1/2" basswood, pine, spruce, or practically any other hardwood you have on hand. Do not make the rails out of balsa! Further instructions on the use of servo trays are usually supplied with them.

In the Astro-Hog the fore and aft location of the servos is not critical for balancing purposes. In all of our prototype models, the servos were centered directly under the former F3. Trim away the bottom of F3 flush with the lit-ply cockpit floor so the servos can be mounted high enough in the fuselage. (If your servos are not overly large, you can probably glue the hardwood servo rails against the bottoms of the 1/4"sq. fuselage corner stringers like we did, see photo.) Glue scraps of balsa sheet to the fuselage sides around the ends of the servo rails so that they can never come loose in flight.

The photos, drawings and text in these instructions describe the servo and pushrod arrangement that worked out best in our prototype Astro-Hog models. The fuselage servos were mounted side-by-side with the rudder servo on the left, the throttle servo on the right and the elevator servo in the middle. The nose gear and rudder pushrods and control horns were on the left side of the model, while the elevator and throttle pushrods were on the right side.

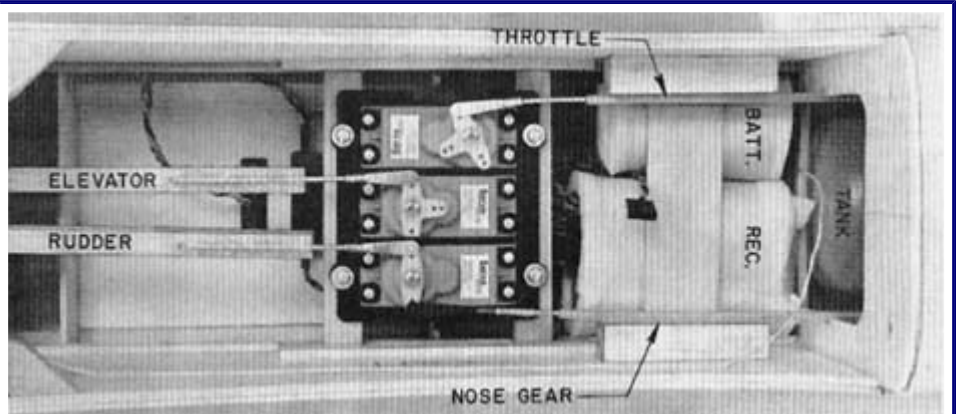

If your radio equipment has servo reversing capability (either in the Tx or via different rotation servos), you will probably find that this arrangement will work well for you too. If you don't have servo reversing you might have to make a slightly different arrangement, changing servo locations or running a pushrod off the opposite side of the servo. Determine which arrangement works best for your particular equipment.

Receiver and Battery Pack(*)

Wrap the receiver and the battery pack separately in foam rubber(*), such as SIGRF240, held on with rubber bands or tape(*), to protect them from engine vibration. The best location in the fuselage for the receiver and battery can't be determined until your model is completely finished. Shifting these components fore or aft slightly can be used to help get the model balanced properly. Final balancing and positioning will depend to a large extent on the engine used. For example: We found that with a light 2-stroke .60 in our Astro-Hog, the receiver and battery both needed to be put under the fuel tank. With a heavier 4-stroke engine in our second Asto-Hog, the receiver and battery were both mounted behind former F2, right in front of the servos. Or it's possible that you might have to put the battery under the tank and the receiver back behind F2. After determining the best locations, glue temporary pieces of scrap balsa across between the fuselage sides to hold the receiver and battery in place so they will not move around in flight.

Switch(*)

The receiver on/off switch can be conveniently mounted in the ply cockpit floor, where it can be easily reached from the outside. You may also find it handy to mount your radio charging jack in the cockpit floor.

OPTIONAL: A Williams Brothers 2-5/8" scale, standard style pilot was used in our prototype models, as shown.

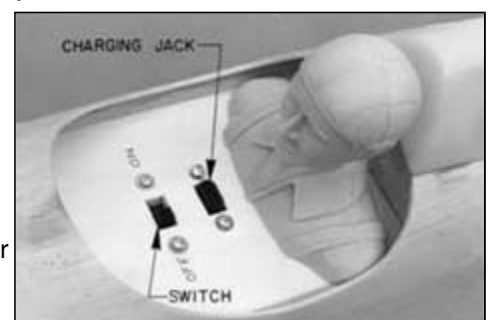

Elevator and Rudder Hookup

Two nylon control horns are supplied for the elevator and rudder. Install the control horns on the control surfaces with #2x3/8" metal screws. Mount one horn on the left side of the rudder, and the other horn on the bottom of the right elevator.

Materials are provided for making 5/16" sq. balsa pushrods to link the elevator and rudder servos to their control horns. Both pushrods are constructed in exactly the same manner.

Make the control surface ends of the pushrods first. Cut and bend a 2-56x10" threaded rod to match the pattern below. Drill a 1/16" dia. hole 2" from one end of the 5/16" sq. balsa pushrod stick. Push the 90 deg. end of the wire rod into the hole, wrap the wire to the stick with thread(*), and coat the winding with glue. Let dry.



Carefully try to determine the spot on the fuselage where the pushrod will exit and line up with the control horn and servo. Cut a 1/8"x1-1/2" slot at this spot. Feed the pushrod through the fuselage, sticking the threaded rod through the slot. Screw a self threading nylon RC link onto the end of the pushrod and hook it up to the control horn.

Hold the control surface in neutral position and cut off the servo end of the balsa pushrod stick about 2" short of reaching the servo's output arm. Unhook the RC link from the control horn and take the pushrod back out of the fuselage. Cut the piece of 1/16"x12" straight music wire that is furnished into two 6" long pieces. Put a 90 deg. bend into one end of the 6" wire and then bind that wire with thread to the servo end of the pushrod stick in the same manner you did the other end. Coat with glue and let dry.

Feed the pushrod back into the fuselage and hook it back up to the control horn. Make sure the nylon link is centered halfway on the threads at the tail end so that you will have equal adjustment range either way. Then hold the control surface in neutral position and install your choice of servo connector(* See below).

Complete both the elevator and rudder pushrods and make sure both operate smoothly. If necessary, recut the exit slots in the fuselage sides so that they don't interfere with the pushrod's movement. Fill in the miscut portion of the slot with scrap balsa and sand smooth.

You also may elect to install optional plastic pushrod exit guides(*), like those that appear in the photos of our first prototype model.

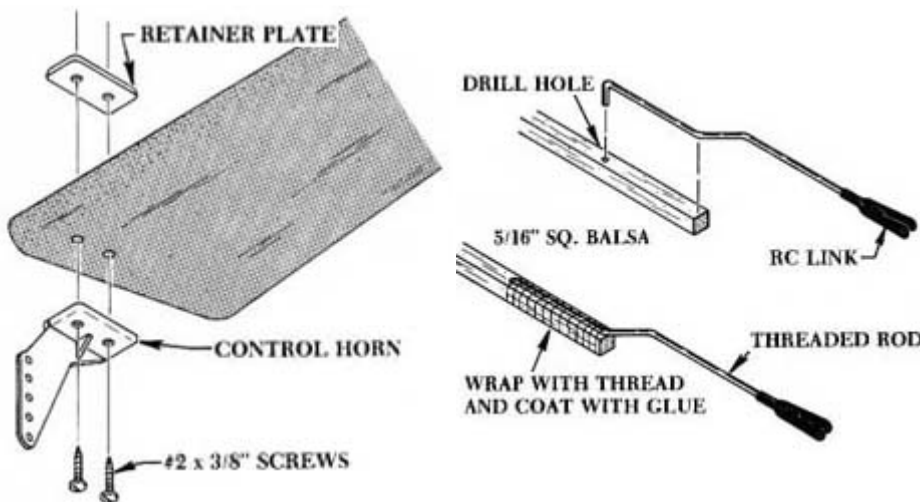

SERVO CONNECTORS

A wide variety of servo connectors are available from the Sig Catalog for attaching the servo end of each pushrod to its servo output arm. No servo connectors are supplied with this kit because modelers usually develop a personal preference for one type over another and often already have them on hand. You will need a total of 6 servo connectors for the Astro-Hog - 1 each for the elevator, rudder, throttle, and nose gear; and 2 for the ailerons. Here are photos of a few types.

Sig Solder Clevises (SIGSH527) are dependable and very easy to install. They can be soldered onto the end of any of the pushrods in the Astro-Hog, either plain 1/16" wire or tinned flexible-cable. Notice in the radio installation photos that the solder clevises were used on all of the pushrods in our prototype Astro-Hogs. If you are unsure what type of servo connector to use, try solder clevises.

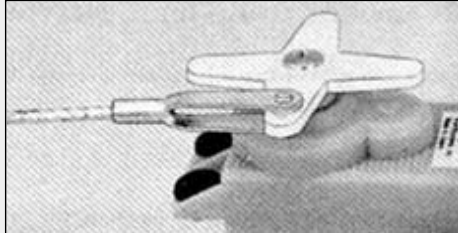

Du-Bro 1/16" Ball Links (#190) get the pushrod action up above the servo control arm to avoid any chance of interfering with the arm's center post. It is good for cable or wire pushrods. A fine adjustment of the pushrod length can be made by screwing the end in and out.

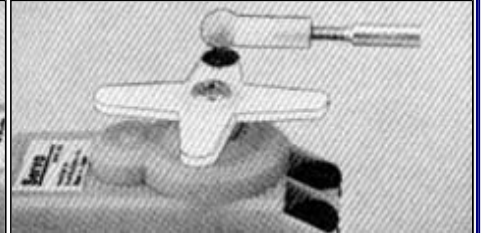

A Sig pushrod connector (SIGSH736) is especially handy for cable end attachment. One is supplied in the kit for holding up the firewall end of the nose gear steering pushrod to the nylon steering arm. They can also be used for the servo end of any of the Astro-Hog pushrods, either wire or cable.

Sig Nylon Pushrod Keepers (SIGSH184) can be used on a 1/16" wire pushrod after the end of the wire has been bent 90 deg. and inserted into the servo arm. Not recommended for cable pushrods.

You won't need any connector for the 1/16" wire pushrods if you can put a "Z" bend in the end of the wire. It's a little tricky to make a good clean "Z" bend, so practice with some scrap wire before trying it on your good pushrod. Not suitable for cable pushrods.

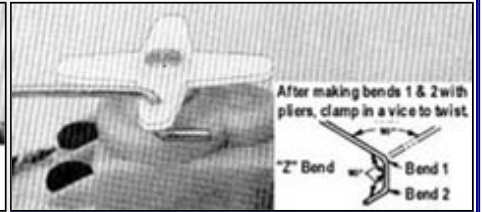
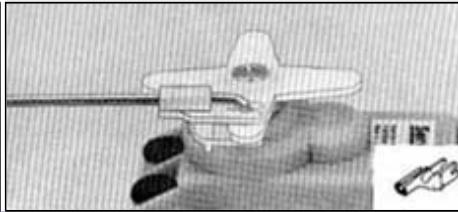
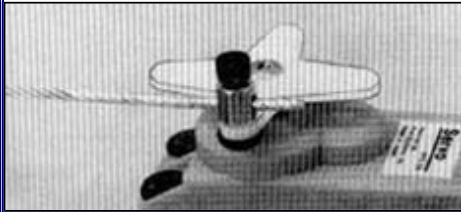

Throttle Hookup

Materials are provided for making a flexible cable pushrod to link the throttle servo to the engine's carburetor control arm. The pushrod consists of a 1/16" dia. steel cable sliding inside a round nylon outer tube. The pushrod is semi-flexible, which means it can be bent in gradual flowing curves if necessary to make its ends line up with the servo and carburetor control arms (it's hardly ever a straight line shot between these two places in the model).

Construct the pushrod by first cutting the 32" long piece of nylon outer tubing provided in half. Slide one of the 16" long pieces through the hole in the firewall that was drilled for it during step 5i. Direct the tubing back around the fuel tank towards the throttle servo arm. Keep any curves in the tube as smooth and gradual as possible. Do not glue the tube in yet!

Sweat solder the threaded coupler provided onto one end of the 1/16" steel cable (see "Preparing Cable Pushrods" below). When cool, screw a nylon RC link halfway into the threaded coupler. Then feed the other end of the cable into the nylon tube from the front and push it all the way back into the fuselage until the RC link can be snapped onto the engine's throttle arm. Check the movement of the throttle by working the servo end of the cable by hand. It should be smooth and free! Epoxy the outer tube into the hole in the firewall after you've determined how much of it needs to stick out the front to support the cable.



Moving the servo end of the pushrod, cut a support block(*) from scrap balsa and glue it in place against the fuselage side about 2" ahead of the servo's output arm, and at the same height as the arm. Shape the block so that the nylon tube can be glued to it and will aim the pushrod cable directly at the servo arm. When satisfied, epoxy the nylon outer tube to the support block.

Cut the nylon tube and the cable to the final length needed to accommodate your choice of servo connector(*) and install it into the end of the cable.

PREPARING CABLE PUSHRODS

To keep ends of cable from unraveling during handling, tin the end with solder. Use a non-corrosive paste flux (shown here is Kester, available at hardware stores) and rosin core solder. Use a very hot iron to heat the cable and then flow the solder completely through the strands.

When cool, grind or file the end smooth. Taper it down slightly so that it will go into the pushrod fittings and nylon outer tube easily..

After the proper length is arrived at, sweat solder the area to be cut so that it will not unravel while being cut. Cut through the tinned area with a good pair of side-cutting pliers, a cut-off wheel on a motor tool or a file.

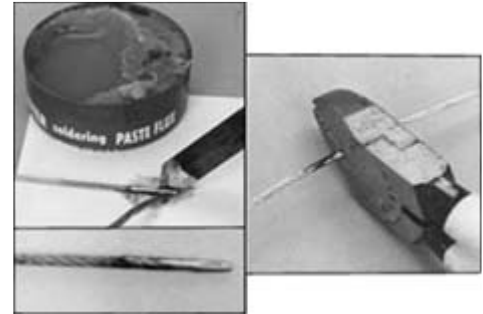

Nose Gear Steering Hookup

A 16" length of nylon outer tubing and 16" of steel cable should be left over from the throttle pushrod installation. Use these pieces to make a pushrod to link the nose gear steering arm to the rudder servo. Install it in the same manner as you did the throttle pushrod.

At the firewall end, use the supplied pushrod connector (as shown in the section 5 diagram) to fasten the pushrod cable to the steering arm. Install the connector in the middle hole of the steering arm before bolting the nose gear assembly onto the firewall. Then feed the cable into the hole in the connector and tighten down the clamp screw. Notice that when the nose gear is in neutral position, the steering arm is angled slightly forward. That way when the servo pulls it back for a left turn, the arm will clear the face of the firewall. You'll have to arrive at the proper amount of forward angle for the steering arm by trial and error.

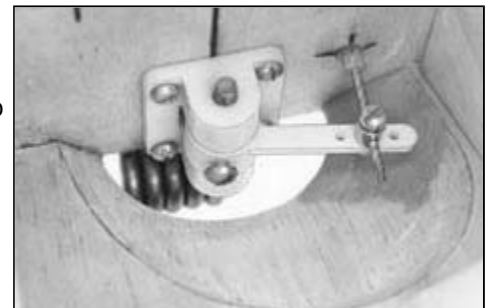

At the servo end of the steering pushrod, shape and install a scrap balsa block to support the end of the nylon outer tube and aim the cable at the servo arm. Install your choice of servo connector(*) onto the end of the cable. In the photo under "Mounting Servos in the Fuselage", you'll see that we elected to use a threaded coupler and metal RC link at the servo end for easy adjustments.

Aileron Hookup

Cut two pieces of hardwood to serve as mounting rails(*) for the aileron servo. Glue them into the pocket in the center of the wing. When dry, mount your aileron servo to the hardwood rails. The exact dimensions and location for the rails must be tailored to fit the size of your particular servo. Plan your installation so that the servo is mounted as low in the wing pocket as possible.

The aileron pushrods are made from two 2-56x10" threaded rods. Screw a nylon RC link onto the threaded end of each rod. Next screw the self-threading nylon aileron connectors that are provided halfway down the aileron torque rods that are sticking out of the wing. Snap the RC links into the aileron connectors and line up the pushrods with the servo arms. Then cut off the pushrod wires to accommodate your choice of servo connectors(*) and install them.

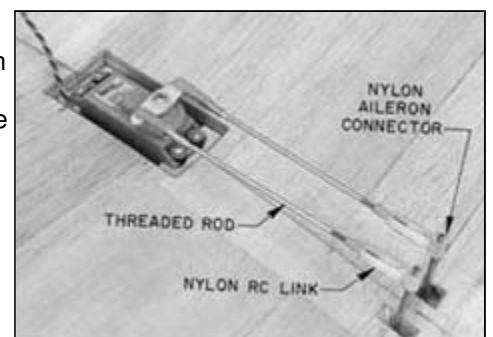

14. TIPS ON TANKS

A 12oz plastic clunk-type tank is recommended for use with most .60 size 2-stroke engines. If you are using a .60 4-stroke or a .45 - .50 2-stroke, then you might want to use an 8 or 10oz tank. Refer to the engine manufacturers instructions for any special notes that they may have on fuel tank requirements for your particular engine.

The shape of the fuel tank can be either round or rectangular. Either shape will fit equally well inside the Astro-Hog. We feel that for most typical engine installations a standard style tank with the cap hole at the front, is the easiest to install. However, for a 4-stroke engine which has the carburetor on the back, you might find that a slant or shelf-style tank will work better. They have the tank cap hole recessed back away from the firewall.



The simplest, most trouble free fuel tank setup is with normal suction feed. Assemble the fuel tank hardware as shown in the photo. There are 2 tubes installed through the rubber stopper - 1 for fuel feed and 1 for overflow vent. The vent tube should curve upwards inside the tank.

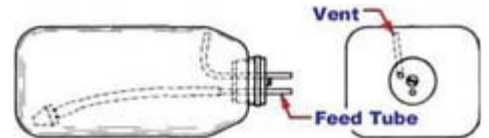

The clunk line on the feedtube must swing freely without hitting the back of the tank. If your tank, as supplied, does not come with silicon tubing for the internal clunk line, substitute a piece of Sig Heat-Proof-Silicon Tubing, SIGSH290 Large (*). With it installed, the tank can be left in the fuselage indefinitely - this line will not harden or deteriorate when immersed in raw fuel.

After the model is covered and painted, you can mount the fuel tank permanently. For best fuel feed with an upright engine, the tank should be mounted as high as possible in the fuselage. Make scrap balsa supports for the bottom and back of the tank to hold it in place. Glue the supports to the fuselage sides. Seal around the hole in the firewall where the fuel line comes through with silicone rubber sealer (*) to prevent exhaust oil from leaking inside the fuselage. Should the need ever arise to remove the tank for servicing, simply break away the balsa supports and silicone.

Use Sig Heat-Proof-Silicon Fuel Tubing to connect the tank's feed tube to the engine's carburetor. Use another length of silicone fuel tubing to extend the tank vent out the bottom of the cowl. To fill the tank with fuel, disconnect the fuel feed line from the carburetor and pump the fuel in there until it runs out the vent line.

Optional Muffler Pressure Feed

If the engine you are using is equipped with a muffler that has a pressure tap in it, make use of it for a more reliable fuel feed. The hookup for pressure feed is shown in the picture. The internal arrangement of the tubes in the tank is the same as shown for normal suction feed. To fill the tank, remove the fuel line from the carburetor and pump the fuel in there. When the tank is full, it will overflow through the muffler pressure line. Stop pumping when you see the fuel reach the muffler pressure line. Should some fuel happen to get in the muffler, drain it out before starting the engine.



15. LANDING GEAR

Main Gear

Grind, file, or sand any burrs off the ends of the preformed 5/32" main gear wires. Insert the wires into the grooved landing gear blocks built into the bottom of the wing. It may be necessary to clean out the landing gear block hole and groove a little to let the wires slip in and out easily. The wires are designed to be removable. Four nylon landing gear straps and eight #2x3/8" metal screws are supplied for holding the main gear wires in the grooved blocks. Use two straps per wire. Mark and drill 1/16" dia. pilot holes in the grooved blocks for the screws.

Do not glue the wires into the blocks!

3" diameter wheels(*) are recommended for the main gear. Retain the wheels on the axles with 5/32" i.d. wheel collars(*)

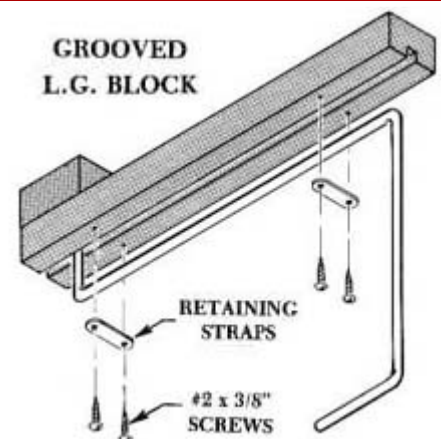

Nose Gear

A drawing of the nose gear assembly is included in section 5. When putting the nose gear together you can adjust the length of the wire strut a little if necessary to get the model to sit at the proper ground attitude. The Astro-Hog should sit on its trike gear perfectly level or just slightly nose up in relation to the ground for best takeoff and landing characteristics. The adjustment is made by loosening the set screw in the steering arm and sliding the wire strut further in or out of the nose gear bearing.

A 2-3/4" diameter wheel(*) is recommended for the nose gear. Retain the wheel on the axle with 5/32" i.d. wheel collars(*).

Optional Taildragger Landing Gear

All of the patterns necessary to convert your Astro-Hog from the standard trike gear arrangement back to the original taildragger configuration are shown on plan sheet 2. No extra materials are furnished for making the conversion, however many of the parts that are in the kit are common to both types of landing gear.

Extra Parts Needed(*): Note that the trike main gear wires supplied in the kit are different from the taildragger mains shown on the plan and will not work. You can either bend your own taildragger main gear wires and tailwheel wire to match the patterns on the plan, or write to Sig about purchasing a pre-bent set direct from the factory. Ask for the Astro-Hog Taildragger Wire Set SIGRPCK255. The set includes 1 pair of main gear wires, 1 tailwheel wire, and 1 nylon tailwheel bracket. You will also need two 3-1/2" dia. wheels for the main gear and one 1-1/4" dia. wheel for the tail, plus the appropriate wheel collars. All other parts you need (grooved landing gear blocks, nylon retaining straps, scrap plywood etc.) are already in the kit for the trike gear version and can be used in the conversion.

The following is an exact listing of the differences in the construction sequence required for building the taildragger version.

- a. Step 1c - Same except, open up notches in front of the spar slots instead of the notches behind.
- b. Steps 5f, 5g, and 5h - Omit
- c. Step 7i - Omit
- d. Step 13 "Nose Gear Steering Hookup" - Omit
- e. Step 15 "Main Gear" - All the same except main wheel size for taildragger is 3-1/2" dia.
- f. Step 15 "Nose Gear" - Omit

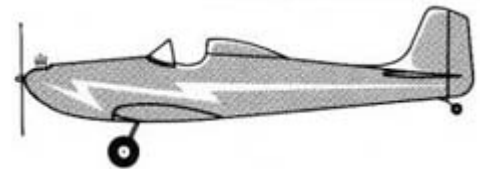

Tailwheel Assembly- Using the pattern on the plan, Cut a 3/32" plywood mount out of scrap from the die-cut plywood sheet that F1A and F1B came in. Notch the bottom rear of the fuselage and epoxy the ply mount in place. Let dry.

Insert the tailwheel wire into the nylon bracket. Bend the top section of the wire parallel with the bottom of the rudder. Insert the wire into the bottom of the rudder and screw the nylon bracket in place on the fuselage with #2x3/8" metal screws. Reinforce the bottom of the rudder with fiberglass cloth and epoxy glue.

A 1" or 1-1/4" dia. tailwheel(*) is recommended. Retain it on the axle with 1/16" i.d. wheel collars(*).

16. COVERING AND PAINTING THE FRAMEWORK

Remove the landing gear, radio, engine, and fuel tank before painting.

All of our prototype Astro-Hogs were covered with Sig Koverall fabric and painted with either Sig Supercoat Dope or Sig Skybrite Paint - see Sig Catalog. An iron-on covering material (either plastic or treated fabric) that doesn't require painting could also be used. Whatever type of covering you desire to use, it will not conceal a rough framework. Be sure all surfaces are smooth before proceeding.

The manufacturer's directions for applying iron-on coverings are packed with the material. Follow these closely, for different types of material have different iron-on temperatures and techniques of application.

The rest of these instructions describe the use of Sig Koverall. Koverall is a polyester-base, heat shrinkable, synthetic fabric much like the covering that is used on classic full-scale airplanes. It is relatively low cost and super strong. The Koverall should be adhered to the balsa model framework with Sig Nitrate Clear Dope (Do not substitute butyrate clear dope if you want to use Skybrite Paint for the final color finish).

Start by brushing an unthinned coat of clear dope over all parts of the framework that will contact the covering. When dry, resand with fine sandpaper to remove any fuzz or raised grain. Brush on a second coat and sand again.

The bottom of the wing is a good place to start covering. Cut a piece of material about 1/2" larger all around than half of the wing, with the grain running lengthwise. (The grain of woven materials runs parallel to the finished bias edge). Lay the Koverall on the wing, pulling the wrinkles and stretching it smooth. Brush clear dope around all the edges. This will soak through the fabric and adhere it to the dope already dried into the framework. Let dry before trimming off the excess material with a sharp razor blade. Check for any rough edges or places that are not stuck down properly and apply more dope. Let dry.

After both sides of the wing are covered, use a hot air gun, hair dryer, or household iron to shrink the Koverall tight (read the Koverall package instructions).

Repeat the process until the entire model is covered. Then give the whole airplane a coat of clear dope. Thin the dope until it brushes on easily and flows out smooth. Brush the dope on sparingly over the open framework areas. If too much is applied, the excess dope may rub off the brush, run completely through the covering and puddle against the covering surface on the other side. When these puddles dry, the large amounts of dope solids in them cause more shrinkage than in the rest of the covering and a scarred area may result. So apply dope lightly the first time over. The second coat of clear dope will seal most of the pores of the Koverall and from there on running through will not be a problem. Sand the model lightly with fine sandpaper after the second coat is dry. Then give it a third coat of clear dope and when dry, sand again.

The model is now ready to be finished with either Sig Supercoat Dope or Sig Skybrite Paint. Further instructions on the application of these two finishes is included with them. Do not try to mix different brands of paint. Use Sig products from the start and follow the instructions that come with them carefully for best results.

17. INSTALLING THE WINDSHIELD

Cut the windshield from the 3-3/8"x8-1/2" clear plastic sheet provided, using the pattern on the plan.

Pin the windshield in place on the fuselage for a trial fit.

When satisfied with the positioning, glue it to the model with Sigment solvent-base model cement or cyanoacrylate "super" glue.

Optional:

Cover the glue seam when dry with a strip of plastic trim tape (* such as Sig Superstripe) for a neat finished appearance.

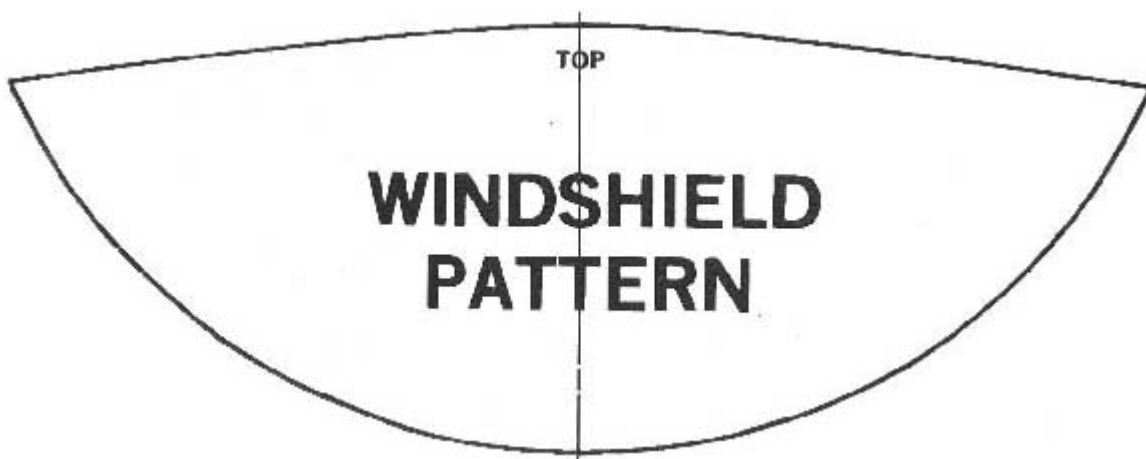

18. PRE-FLIGHT

Be certain to range check your radio equipment according to the manufacturer's instructions before attempting test flights. A lot of problems can also be avoided if your engine has been well broken in and the idle adjustment perfected on a test block or in another airplane before installation in the new model.

Various brands of servos can give different amounts of control surface travel. By moving your pushrod linkages into a different hole of the control horn and/or into different hole of the servo arm, you can change the total amount of control surface travel you'll get when the Tx stick is moved to full throw position. Adjust your pushrod linkages to produce the amounts of movement listed below. Measurements are made at the trailing edge of the control surface.

RECOMMENDED CONTROL SURFACE MOVEMENTS For test flying, the following are suggested:	ELEVATOR	3/4" UP and 3/4" DOWN
	RUDDER	1" RIGHT and 1" LEFT
	AILERON	3/8" UP and 3/8" DOWN

The control measurements listed above should give full aerobatic capability if your Astro-Hog is properly balanced. Test flights may indicate a need for slightly more or less movement, depending on individual model performance and personal preference.

Before flying, you should also adjust all your pushrod linkages so the control surfaces are in neutral position when the Tx sticks and trim levers are centered in neutral. After the first flight, readjust the linkages if necessary so that the trim levers can be returned to neutral position. It may take several flights before exact trim is established on all the flight controls.

Balance your model at the point indicated on the plan. If it balances further back, add weight to the nose as necessary. Trying to fly with the C.G. too far back is much more dangerous than the slight increase in wing loading caused by adding lead to the nose. Balance with an empty fuel tank.

WHY MODELS MUST BE INDIVIDUALLY BALANCED

It is impossible to produce a kit that will automatically have the correct balance point. Balsa wood varies in weight and so do model engines. The form of muffler you use, the size and placement of your radio equipment and the amount of finish you apply can also affect the balance. Don't feel that whatever C.G. the model builds out to is "good enough". Check carefully and make whatever adjustments that are required. With the C.G. properly located, the Astro-Hog should fly with only minor trim changes required.

18. FLYING

The Astro-Hog is not difficult to manage on the ground or in the air. However, it is not a basic trainer. If you have no previous RC experience we suggest that you not attempt to fly your Astro-Hog without the assistance of an experienced pilot. Contact your local club or ask your hobby dealer for the names of good fliers in your vicinity and a suitable location for flying. Many hours of work are involved in the construction of a model and it can be lost in a moment of beginner's indecision. A skilled flier can help you get past the first critical test and trimming flights without damage to the model. To a pilot who has learned the basic skills, the Astro-Hog will be a very easy airplane to fly.



Line the Astro-Hog up in the middle of the runway for takeoff. If you haven't had much experience, it's best to stand directly behind the model so that you can easily see any changes in heading that will need to be corrected during the takeoff run. Leave the elevator in neutral. As you advance the throttle smoothly to full open, the Astro-Hog will try to drift to the left from torque. Feed in right-rudder as needed to keep the model going straight. When you have reached flying speed, pull back slightly on the elevator stick for a gentle liftoff.

During the takeoff run, try not to overcontrol the nose gear steering (the most common rookie pilot's mistake) which will start the Astro-Hog swerving from one side of the runway to the other. If you find yourself in that situation, pull the throttle back to full low and get the model stopped. Taxi back for a fresh start. Never try to hurry the model off the ground by pulling full up elevator just because the model isn't going straight! The damage from a premature snap roll on takeoff would be much more severe than anything that could happen on the ground. Just keep practicing your takeoff runs without lifting off until you learn to use the throttle, elevators, and rudder together.

In the air, you will find the Astro-Hog smooth, stable and responsive. It will perform all the basic aerobatic maneuvers with ease. After you've had a chance to get the model trimmed out, you might want to experiment with slight changes in control surface travel until the model reacts just the way you want it to. Increasing the surface travel will make the model react much quicker, but it can also make the model "touchy" in level flight if you go too far. Shifting the balance point slightly (1/2" maximum) forward or backward can also change the model's flight characteristics.

Having the balance point forward will make the model more stable and less likely to do snap and spin maneuvers. Having the balance point further back will make the model react faster and more extremely to control inputs, to the point of making it hard to control if carried too far.

If these ideas make it seem that the Astro-Hog is difficult to fly, it really isn't. These are basic laws of airplane design that apply to all models, not just the Astro-Hog. Experimenting with different balance points should only be attempted by experienced pilots. You'll most likely find that your Astro-Hog will fly very well with the balance point shown on the plans. That's where all our prototype model's balance.



The Astr-Hog can be safely flown by anyone who is capable of handling a multi-channel RC model. In fact, you will probably come to agree with hundreds of modelers before you - that the Astro-Hog is a very special design.

It's a real pleasure to fly!

© Copyright SIG Mfg. Co., Inc.

SIG MFG. CO., INC.....Montezuma, Iowa 50171-0520

LIMIT OF LIABILITY:

In use of our products, Sig Mfg. Co.'s only obligation shall be to replace such quantity of the product proven to be defective. User shall determine the suitability of the product for his or her intended use and shall assume all risk and liability in connection therewith.