



CLIPPED WING CUB

1/4 Scale SIGRC47



BUILDING and FLYING INSTRUCTIONS

The Clipped Wing Cub Story

The classic Piper J-3 Cub has been America's favorite light plane for over 40 years. More than 20,000 of them were built between 1937 and 1947 for both civilian and military use. By 1980, the number of still airworthy J-3's in the U.S. had declined to approximately 3,600. One of these bears registration N32629 and is recognized worldwide as Hazel Sig's Clipped Wing Cub. N32629 was manufactured in 1941 at the Piper factory in Lock Haven, Pennsylvania as a standard Piper J-3C-65 Cub, serial number 5498. Not much is known about the first 12 years of its life. The first logged entry was made on February 12, 1953 by a flier in Frederick, Oklahoma. He said; "The previous owner did not comply with CAR. 43-22 on the maintenance of aircraft records. The aircraft log, if maintained, has been lost or destroyed. From known information, the aircraft has been estimated to have approximately 4000 hours total time". With that many hours of flight time accumulated in just 12 years, it's pretty safe to assume that N32629 was used for flight training during the 1940's. The Cub was sold in 1955 to an A & E mechanic who moved it to Mount Pleasant, Iowa. It remained in Iowa through the 1960's, being used by several different owners for pleasure flying.

Hazel Sig, president of SIG MFG. CO., purchased N32629 in January of 1968. She flew the J-3 in its standard form through the spring and summer of that year. The log books showed that the Cub had been covered with ceconite and painted with enamel in 1965, just three years before Hazel bought it. The ceconite and enamel turned out to be a bad combination. After the simplest aerobatics, the enamel had begun to crack and loosen from the fabric in several places. It was soon obvious that the Cub was going to need recovering again in the near future, much sooner than should have been the case.



Hazel Sig standing beside her newly acquired standard Piper J-3 Cub at Sig Field Montezuma, January 1968. At that time, N32629 was painted cub yellow with red trim and black registration numbers. It was manufactured in 1941.

As it turned out, a late-summer '68 wind storm brought the Cub's covering problems to a head. With the storm fast approaching and no hangar space available, Hazel quickly tied the Cub down outside. To keep the rudder from slamming from side to side in the gusty wind, she grabbed a roll of duct tape and taped the rudder to the fin. Needless to say the tape held perfectly during the storm, but when she tried to take it off later, huge chunks of enamel came off with it. The recovering project couldn't be put off any longer.

After retaping over the bare fabric spots, Hazel flew the wounded Cub to the Ottumwa, Iowa airport. There the entire airplane was stripped of its covering and inspected. It turned out to be in worse shape than originally thought. The wooden wing spar had been damaged by mice and hastily varnished over in '65. The control cables were brittle. The engine needed an overhaul. And the list kept growing. The Cub needed to be completely rebuilt!

Driving to Ottumwa (50 miles) every night after work, Hazel completely disassembled the J-3. For better aerobatic performance, she had 40" clipped off the inboard (cabin) end of both the right and left wing panels. This was done by a licensed mechanic in accordance with FAA approved modification that were developed by aerobatic pilot Earl C. Reed in 1953 for his Cub. (Several other J-3 Cubs have also been modified using Earl's plans.) All the steel tubing framework in Hazel's Cub was cleaned by sandblasting and primed with zinc chromate. The wooden parts were repaired or replaced as needed. The Continental A65-8F engine was completely overhauled and modified to produce 75 h.p. instead of its normal 65.

Hazel, assisted by her husband Glen and plant superintendent Maxey Hester, then trucked the Cub parts back to Montezuma and put them in a basement room of the SIG factory. Over the winter months they recovered the airplane with grade "A" cotton. When it came time for the color painting Hazel, Glen and Maxey all had different ideas. They agreed on the sunburst pattern, but according to Hazel; "Glen wanted it to be red and white, Maxey like blue and white, and I thought yellow and white would look best. As you can see, "Maxey is the one who actually loaded the spray gun".



The almost-done Cub took another truck ride back to Ottumwa in the spring of 1969 for reassembly.

Hazel Sig taxis her rebuilt Clipped Wing Cub out of the hangar for its very first test flight at the Ottumwa Airport in the summer of 1969. Approximately 3-112 feet was clipped off the root of each wing panel for better aerobatic performance.

New cowlings, windshield, side windows, tailwheel, and metal prop were installed. Added touches like chromed cylinder heads and top shrouds, streamlined bungee covers, a personalized Cub bear emblem, radio gear, and a new interior made Hazel's Clipped Wing Cub one of a kind.

The first test flight of the reborn Cub was made at the Ottumwa airport in the late summer of 1969 with Hazel at the controls. Modelers got their first glimpse of the Clipped Wing when she flew it to Doylestown, Pennsylvania for the 1970 RC Aerobatic World Championships. Since that time, thousands of model versions of the Clipped Wing Cub have been built and flown all over the world. Over the years, Hazel has graduated to snappier and more powerful aircraft for her aerobatic flying, but none has captured the attention and affections of modelers as much as the blue and white Cub. It's a very special example of America's favorite airplane!

Engines

The 1/4-scale Clipped Wing Cub can be flown with a wide variety of engines. In fact, there is such a vast number of good quality motors available on the market today for a model of this size and type that it is impossible for us to recommend one particular motor over all others. The engines shown here are just a few of many that we have tried in the Cub. Generally speaking, we've found that any glow model engine either a .60 - .90 size 2-stroke, or a .90 - 1.60 size 4-stroke - can be recommended for the 1/4-scale Cub. Any brand glow engine that you choose, within these limits, should provide your Cub with good flight performance.

2-Stroke or 4-Stroke?

The first choice you must make in selecting an engine for your Cub is to decide whether you want to use a 2-stroke or 4-stroke motor. From the reports that we have received from our customers, 4-stroke engines have proven to be much more popular for the Cub than 2-strokes. In fact, a 4-stroke engine seems to bring out the best in a slow flying airplane like the Cub. That's because a 4-stroke model engine produces its maximum power at a relatively low r.p.m., just like the full-scale Cub's engine. In other words, it more closely duplicates the power curve of the full-scale motor. While a typical 2-stroke R/C sport engine will normally run at between 10,000 to 13,000 r.p.m. in high throttle, a 4-stroke model engine runs about 7,000 to 9,000 r.p.m. in high. That enables the 4-stroke to turn a larger, more scale size propellor than the 2-stroke model engine could. The large, slow turning prop provides more pulling power for a slow flying airplane like the Cub, giving it an excellent rate of climb without having excessive airspeed in level flight. A 4-stroke engine is the best choice if you want your Cub to have super realistic flight performance.

In testing 2-stroke engines in the Cub, we found that a .78 - .90 size 2-stroke provided the best all round performance. Fly it throttled back for realistic speed in level flight and go to full power for aerobatics. We also tried a schneurle-ported .60 2-stroke in one of our Cubs. While it provided very realistic airspeed, most modelers would feel it was underpowered. Even though it would loop out of level flight with no preliminary dive needed, and would cruise in level flight at near scale speed with 3/4 throttle, the climbouts and turns had to be kept very gentle to avoid a stall. A .78 - .90 size 2-stroke provides an extra margin of safety. In conclusion, while a 2-stroke engine can fly the 1/4-scale Cub very well, they do tend to fly the model faster in level flight than a 4-stroke would. You have to run them fast in level flight in order to have good climb performance.

We do not recommend converted "chain saw type" gas engines for this model. They tend to vibrate more than a precision made glow engine and are usually too bulky to fit inside the cowling.

Regardless of what size and type of engine you decide to use, strive to keep your Cub as light as possible for best flight performance.



ENYA .90 4-stroke represents typical installation of a single-cylinder 4-stroke engine in the Cub. Motor is sidemounted for easy starting and dependable Idle. Uses a J'Tee #JT-64 Aluminum Engine Mount, J'Tee #JT-ENS Muffler, and 15-6 prop. No dummy engine needed on this side of the cowling.

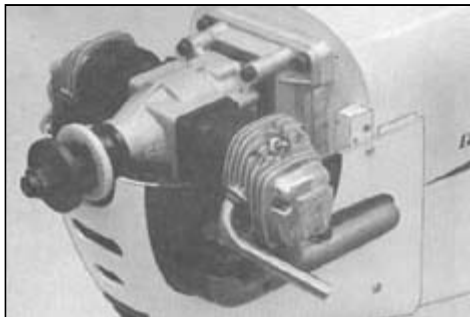

O.S. GEMINI 1.20 twin-cylinder 4-stroke engine mounted in the Cub. Note 3/8" thick spacer between back of engine mount and firewall, to provide correct firewall-to-prop distance. Cowling is modified to come apart in two pieces, ala the full-scale Cub (upper section is removed in photo).

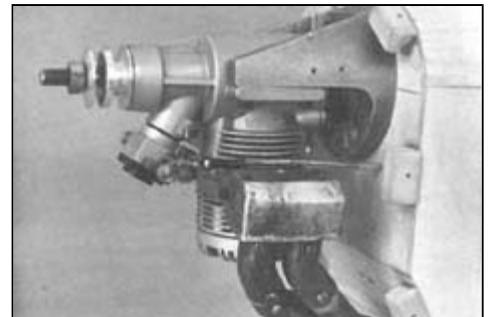

Webra .91 2-stroke engine mounted inverted in the Cub. C.B. Associates 15310 Aluminum Engine Mount, Slimline #3401 Sport Scale Muffler with homemade copper tubing exhaust extensions (plumbing variety copper tubing from hardware store). Inverted engines can be difficult to start.

Mounts

No motor mounts are supplied in this kit because of the wide range of engines that can be used. A suitable radial firewall-type mount (such as Tatone, Fox, CB, Hayes, etc.) should be available for just about any mass produced engine. The distance from the front of the cowling to the firewall is adequate for most all .60 to .90 glow engines. Less common engines may require some preplanning and modification in this area.

Mufflers

There is no one type of muffler that is best suited for the Cub. It all depends on the particular engine that you've elected to use. You will have to figure out your own muffler installation. We have had good luck adapting the "exhaust manifold" type mufflers (such as made by Tatone and Slimline) to most .60 to .90 glow engines. Usually they can be made to fit with just slight alterations. Use copper or heat-proof rubber tubing to extend the exhaust pipes to the outside of the cowling.

Recommended Glues

Sig-Bond (aliphatic resin type) glue works best for the majority of the general framework construction. Areas subjected to unusual strain, or including metal pieces, should be epoxied with Sig Epoxy Glue (slow drying) or Sig Kwik-Set (5-minute) Epoxy Glue. You will also find that the cyanoacrylate type adhesives (Hot Stuff, Jet, etc.) can be extremely quick and handy for some applications. Some of the steps in this instruction sequence call out the specific type of glue to use for that particular assembly. In other areas you can use your own judgement as to which type is best suited to the purpose and your building schedule.

About The Building Sequence

The quickest and most efficient way to complete a model is to work on several pieces at the same time. While the glue is drying on one section you can start on or proceed with another part. The numbering sequence used in this book was chosen as the best way of explaining the building of each major assembly and is not intended to be followed in exact one-two-three fashion. It may be desirable, for example, to start building the wing or tail while the preliminary parts of the fuselage are drying. It is suggested that you read the instruction book and study the plan carefully before beginning to build. That will help make it clear where construction out of the descriptive sequence can be done.

Notes Before Beginning Construction

Any reference to right or left refers to right or left as if you were seated in the cockpit. Building large airplanes requires a large building board! For this Cub, you will need a board that is at least 18" wide x 72" long. It must be perfectly flat and untwisted. If you don't have one that big, go to the local lumber yard and purchase a "door core" of at least these dimensions. Door cores are normally very straight and true (be sure to inspect it before buying), and they are not too expensive.

A piece of thin foam board or celotex-type wallboard makes a handy top surface for your building board, into which pins can be easily pushed. Don't be afraid to use plenty of pins while building, particularly when gluing planking on the top curve of the wing or the round top of the nose. Due to their large size, the full-size fuselage and wing plans had to be drawn in two pieces. Cut out the adjoining pieces and carefully tape them together along the break lines. Wax paper should be used to protect the plans during building.

Be careful where you use a ball point pen for making marks on the model during construction. If not sanded off, these marks may bleed through many coats of dope and show on the finished model. Cut all long pieces of balsa first, followed by medium lengths, before cutting up any full length strips into short pieces. Leave the die-cut parts in the sheets until needed in construction. Remove pieces from the sheets carefully. If difficulty is encountered, do not force the part from the sheet. Use a modeling knife to cut it free. A jig saw is best for cutting out the printed balsa parts. Cut just outside the lines, leaving all of the line on the part. When fitting the piece into the structure, use a sanding block to bring the edges to an exact fit.



FUSELAGE CONSTRUCTION

1. Building The Fuselage Formers

Due to their large size, some of the fuselage formers could not be furnished in one-piece, but need to be built up from several pieces. Take great care in the next few steps to insure that these formers are built accurately. How well you make them match the plan will determine how well other fuselage parts will fit together later

- Refer to Cross-Section F5 of the full size plans. Former F5 consists of one 1/4" ply Top, two 1/4"x1/2" ply Sides, and one 1/4"x1/2" balsa Bottom. Cut the 1/4"x1/2" ply pieces from the 24" long stock provided. Cut the 1/4"x1/2" balsa Bottom from 36" long stock. A piece of 1/4"x2-1/4"x6-1/4" plywood is provided for the former Top. Cut two 1/2"x15/16" notches in the bottom corners of the top as shown here.
- Cover the Cross-Section F5 drawing with waxed paper and epoxy the pieces of F5 together directly over the drawing.
- Build former F6 directly over plan Cross-Section F6. This former consists simply of four pieces of 1/4"x1/2" balsa, cut from 36" stock.

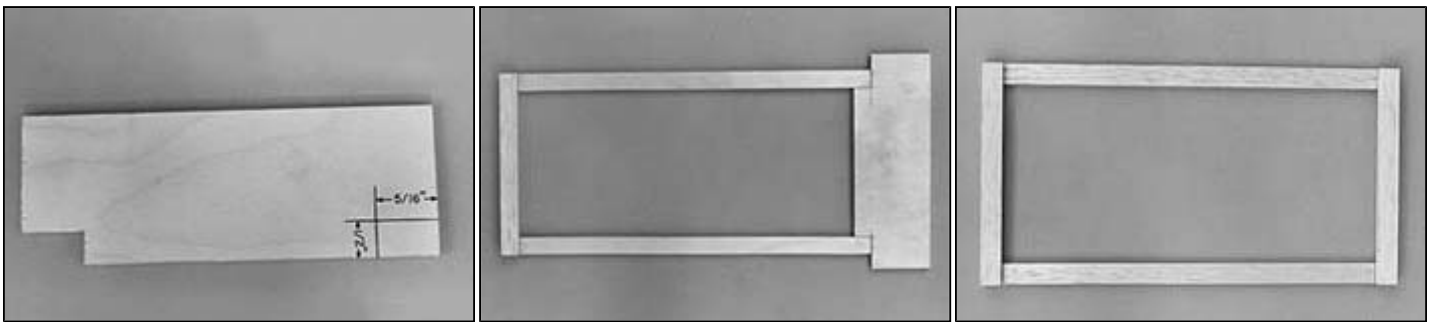

- Former F7 consists of two 1/4"x1/2" balsa Sides, one 1/4"x1/2" balsa Bottom, one printed balsa part F7A, and one die-cut lite-ply Cabin Bulkhead. Cut out these parts and glue together over the F7 CrossSection drawing.

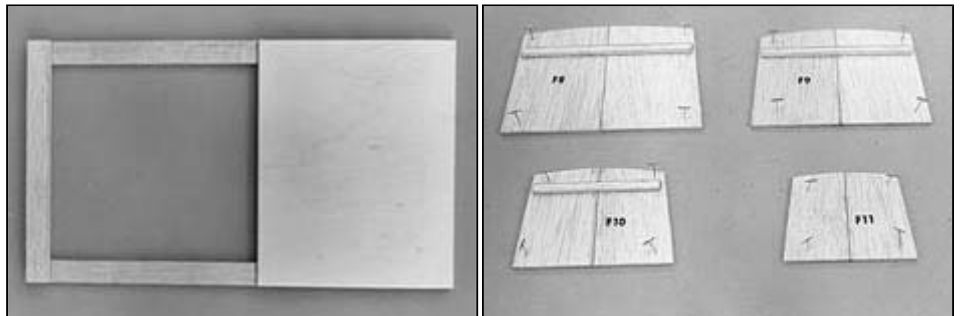

- The die-cut balsa rear fuselage formers F8, F9, F10, and F11 each come in two pieces. Glue the halves together at the center. F8, F9, and F10 should each be reinforced with a piece of 1/8"x1/4" balsa, as shown

2. Fuselage Frame Assembly

- Cut the MF-1, MF-2, MF-3, MF-4 and MF-5 pieces from the 5/16" printed balsa sheets. Cover the Fuselage Main Frame drawing with wax paper or plastic wrap for protection. Using the printed parts and 5/16" square balsa stick, construct two identical main frame sides directly over the drawing. When dry, pin both main frame sides together and lightly even up the edges with a sanding block.
- Epoxy the die-cut lite-ply Fuse Side Sheeting onto the main frame sides. Be sure to make a right and left! And try not to get excess epoxy in the cutouts in the main frame for the landing gear blocks.
- With a sanding block, bevel the inside rear ends of the fuselage sides where they will join together later.
- The top structure of the cabin/window area, where the wing will sit, is a lamination of 1/4"x3/8" spruce to 3/16"x3/8" balsa. From 36" long stock, cut two spruce and two balsa pieces to proper length. Glue the balsa pieces to the spruce pieces in a manner which will give you a Right and Left Cabin Top piece.
- Pin the Right Cabin Top piece in place on the Side View plan (balsa side up). Pin the Right Fuselage Side in place on the plan (plywood side down). Carefully draw lines on these parts to mark the exact locations of formers F5, F6 and F7.

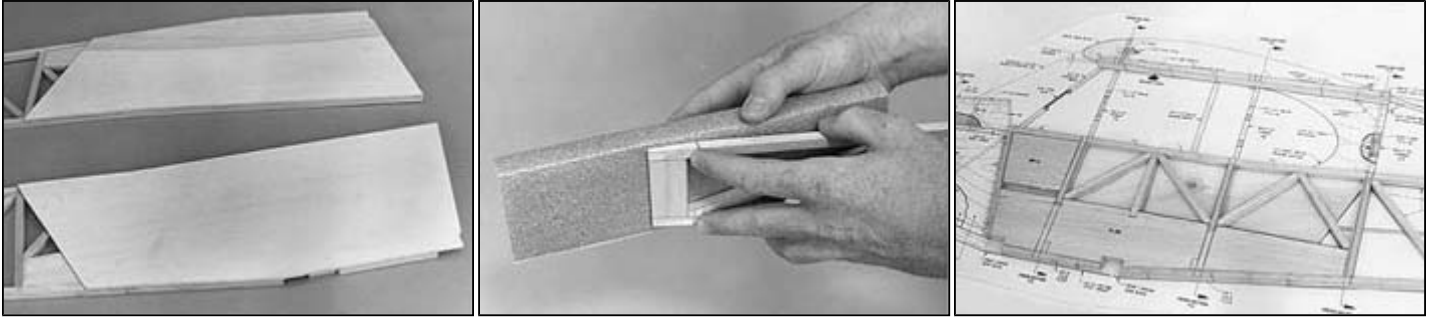

- f. Epoxy formers F5, F6 and F7 to the Right Fuselage Side and Cabin Top piece. Glue them on one at a time with 5-minute epoxy. Use a triangle to get them on square.
- g. Epoxy the Left Cabin Top piece in place along the top of the formers. When dry, measure at each former from the bottom of the Right Cabin Top to the top edge of the Right Fuse Side. Then transfer this measurement onto the left side of the formers, this time measuring down from the bottom of the just-installed Left Cabin Top. These marks will come in handy as a guide when aligning the Left Fuse Side in the next step.
- h. Epoxy the Left Fuselage Side onto the formers. Accurate positioning during this assembly is very critical for a straight fuselage! It's best to mark the former locations on the inside of the Fuse Side before gluing them on. We prefer to use slow drying epoxy and lots of pins so that there is plenty of time for getting an accurate alignment of the fuse sides to each other before the glue dries. And don't forget to check that the sides will properly line up with each other at the tail end. Let dry.

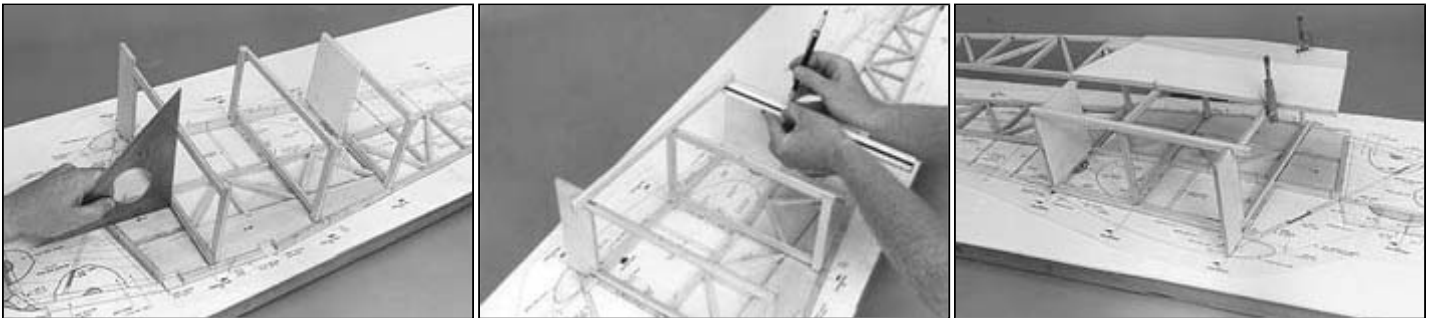

- i. Epoxy 1/8"x1"x6" plywood Landing Gear Block Doublers to the top side of the Grooved Landing Gear Blocks. When dry, epoxy the blocks in place in the fuselage. Make sure that the grooves in the blocks are 5-7/8" apart as shown in the side view fuselage plan.
- j. Epoxy the 1/8"x1"x6" plywood Strut Mount Insert in front of the rear Landing Gear Block
- k. Set the fuselage on the Top View plan, pinning down the area between formers F6 and F7. Pull in the rear ends of the fuse sides and glue together parts MF-5 where they meet on the center line of the plan. Let dry.
NOTE: With the rear half of the fuselage down against the plan, the length and curve of the sides won't match that drawn on the plan. This isn't a mistake but simply because the Top View plan shows the fuselage as it would look from above when the fuselage is sitting level not like it is now with the upswept rear half sitting flat on the plan.
- l. Consequently, to join the remainder of the rear fuselage, first unpin the fuselage from the plan after the MF-5 joint is dry. Then cut the 5/16" square balsa cross-pieces to length according to the patterns for each that are drawn alongside the Top View. Glue and pin these in place starting with the F13 cross-pieces, and then working forward.



3. Nose Assembly

- a. Epoxy the die-cut plywood firewall parts F1A, F1B and F1C together. Make certain that F1C is centered on the back. Carefully mark the vertical centerline and the thrust line on the front of the firewall assembly. Position your engine mount on the front of the firewall, drill holes for mounting, and install blind nuts.
- b. Join the nose main frame sides at the top with the die-cut lite-ply Nose Joiner. Note that the Joiner should not be flush with the front of the sides, but leaves clearance room for F1C.

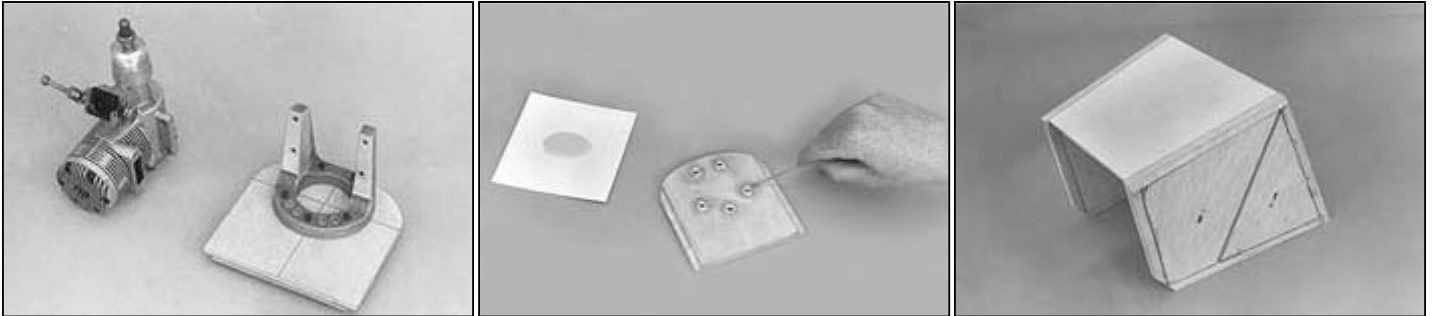

- c. Epoxy the nose assembly to the fuselage main frame. Make sure that the nose main frame sides are lined up with the fuse main frame not flush with the lite-ply fuse side sheeting. The nose will have its own lite-ply side sheeting added later.
- d. Epoxy the firewall assembly in place. Double check with the Side View plan that you get it correctly located vertically. The easiest way is to draw the thrust line on the main frame sides and match up the line on the firewall with it.
- e. Refer to the F5 cross-section drawing. Make a $5/32$ "x $5/16$ " hole in the top of plywood former F5 where the $5/32$ " Cabin Wires will pass through.
- f. Cut a groove through the top $5/16$ " square main frame pieces so the Cabin Wires can enter the slot that is between MF-1 and MF-2.
- g. Trial fit the Cabin Wires in place and rebend them slightly if necessary to get a good fit in your model. Take coarse grit sandpaper and sand the wires in the areas where they will be glued into the model structure. This will improve glue adhesion. When satisfied with the fit, epoxy the Cabin Wires into the side slots in the nose main frame. Use the glue liberally, to completely cover the wire where it imbeds into the structure. Be careful that the wire doesn't stick out past the surface of the main frame since lite-ply sheeting must still be applied later.
- h. Wrap with copper wire and solder the Cabin Wires together where they meet at the front of former F5. When cool, clean any excess solder flux off the wires and surrounding plywood with dope thinner and a stiff nylon brush. Let the thinner evaporate out. Smear a fillet of epoxy around the wire binding and onto the front of F5 where they meet.

SPECIAL NOTE:

It is best to make provisions now for the fuel tank mounting, while you still have easy access through the bottom of the nose. Refer ahead to "Tips On Tanks" (section 18), for some recommendation on the type of setup to use. At this time you should drill any necessary fuel line holes in the firewall, and make any provisions you prefer for securing the tank in position.

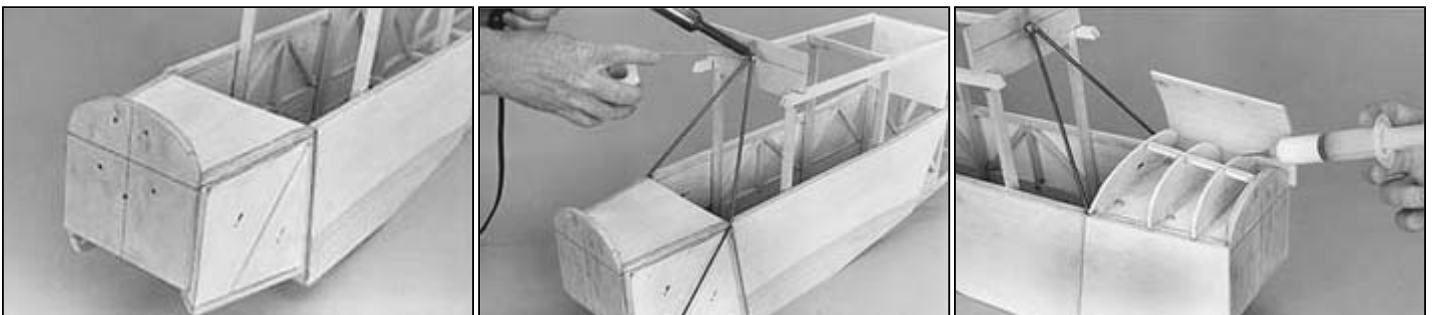

i. Glue in place balsa formers F2, F3 and F4, and the 1/4" square balsa stringer that goes between them. Check the exact locations of the formers carefully. When dry, lightly touch up the edges of the formers by running a sanding block over all three and the ply firewall at the same time.

j. Sand the sides of the firewall flush with the main frame. Glue on the die-cut lite-ply Nose Side Sheeting.

k. A 1/8"x4"x18" balsa sheet is provided for planking over the top of the nose formers. It may be necessary to wet the outside of the sheeting slightly with water to get it to bend easily around the formers.

4. Cabin Area

a. Add 3/16"x3/8" balsa fill-in pieces to each side of former F7.

b. Cut out and glue in place the 1/4" printed balsa Window Outlines. They should be glued in flush with the outer surface of the lite-ply Fuse Sides and the spruce Cabin Tops.

c. Fill in along both sides of formers F5 and F6 with 1/4"x1/2" balsa. These will stick out past the surface of the lite-ply and spruce slightly, but will be sanded flush later.

d. Add 1/4"x1/2" balsa Window Braces to both sides of the cabin, where shown on the plan just ahead of former F6. Glue these in flush with the Fuse Sides and Cabin Tops.

e. Install F5G gussets on the back of former F5, to brace it to the Cabin Top pieces.

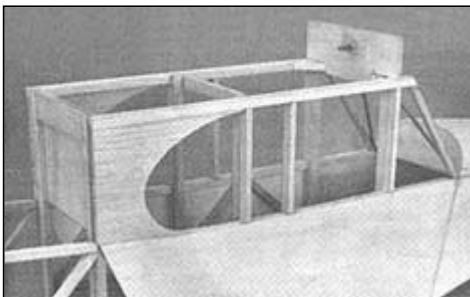

Steerable Tailwheel Unit Assembly

1. Temporarily bolt the two formed metal Leaf Springs together using the 6-32x1/2" Mounting Bolts and the 6-32 Square Anchor Nuts provided. Note in the drawing that the shorter leaf spring goes on top.

2. Push the bottom end of the long Leaf Spring in place inside the Nylon Tailwheel Bearing. Bolt securely with the 4-40x3/8" Mounting Bolts & 4-40 Lock Nuts.

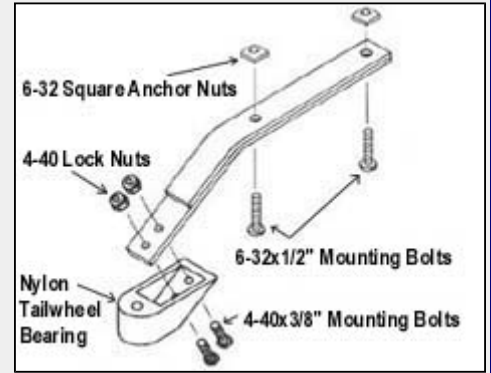

3. Prepare the Formed Tailwheel Wire for installation by first grinding or filing any burrs from both ends of the wire. Next clamp the entire bottom fork of the tailwheel wire in a vice and bend the top shaft backward slightly, so that when installed the tailwheel will be swept back slightly as shown in the full-size side-view drawing on Plan Plate 1.

4. Solder a Flat Metal Washer just above the top bend of the Formed Tailwheel Wire. The purpose of this washer is to keep the wire from riding up too high into the Nylon Tailwheel Bearing and causing a bind. A second Flat Metal Washer is provided to solder onto the axle portion of the tailwheel wire to keep the tailwheel itself from binding against the bend of the wire.

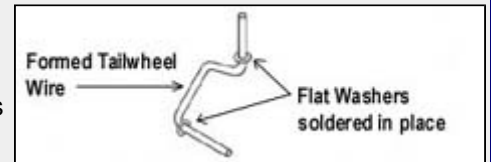

5. Install a 1-1/2" diameter Tailwheel (not furnished) on the axle. Use the 3/32" Wheel Collar and Headless Set Screw provided to hold the tailwheel in place.

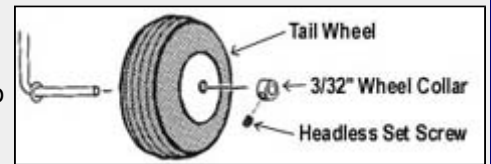

6. Push the other 3/32" Wheel Collar provided into the round cavity in the molded nylon Steering Arm. Make sure that the set screw hole in the wheel collar is lined up with the hole molded into the steering arm. Thread the 4-40 x 3/16" Set Screw (round head) into the wheel collar.

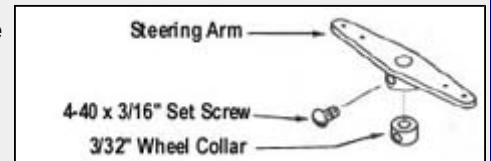

7. Insert the top of the Formed Tailwheel Wire thru the Nylon Tailwheel Bearing and secure in place with the Steering Arm. Be sure to file or grind a small flat spot on the wire where the 4-40 x 3/16" Set Screw will make contact.

8. During final assembly of the model, after all covering and painting is done, link the Steering Arm to the Rudder Control Horn with the two Steering Springs provided. Use a needle nose pliers to bend a hook in each end of the springs to attach in the outermost holes of the steering arm and the back edge of the control horn (see photo in section 23)

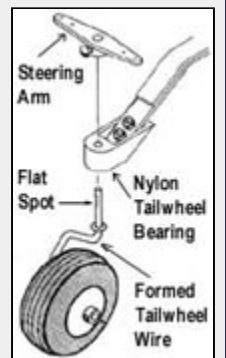
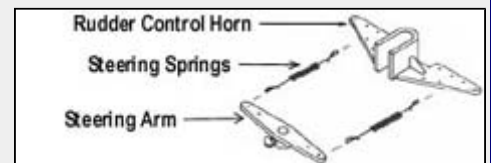

- f. Cut and glue in place the 5/16" sq. balsa front Windshield Braces. They should also be glued in flush with the lite-ply Sides and spruce Cabin Tops. You'll have to hollow out the bottom inside corner of the Windshield Braces slightly so that they will clear the Cabin Wires.
- g. Block sand all the window area flush with the surface of the fuse sides and cabin tops.
- h. Wood for cabin floor pieces CF-1 and CF-2, that go around the landing gear blocks, is available on printed sheet #10. The lines drawn there are not exact size - cut the wood oversize and sand the edges down until the pieces slip into place between the main frame sides. Then glue in flush with the bottom of the fuselage.
- i. Cut out and glue in the CF-3 Nose Fill-In piece
- j. Add the 5/8" balsa Nose Bottom Block. Note proper grain direction.

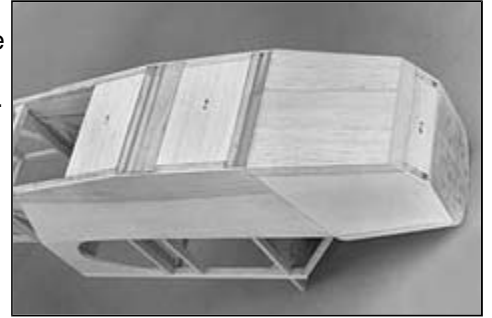

5. Completing The Fuselage

- a. Glue rear formers F8 through F13 in place on the main frame. They must be centered side-to-side. Note in the side view plan how these formers should be sitting straight up and down when the fuselage is propped up level - not installed 90° to the main frame itself.
- b. Glue in place the 1/4" sq. balsa Top Corner Stringers and the 1/4" sq. T.E. Cross-piece that goes on top of former F7. It may be necessary to soak the Corner Stringers in water to get them to bend into shape between formers F7 and F9.
- c. Add the 3/16"x3/8" balsa Top Stringer.
- d. Put scrap balsa gussets on each stringer where they connect to the back of former F7.
- e. Glue on the 1/8"x1/4" balsa Side Stringers. When dry, use a sanding block to taper them near the front and the back as shown in the Fuselage Top View.
- f. Glue on the 1/8"x1/4" balsa Bottom Corner Stringers. Notice in the cross-section drawings that these are glued on flat against the main frame - not on edge as were the Side Stringers. Taper these stringers also, aft of F13, to blend into the end of the fuselage.
- g. Add 1/8" sheet balsa fill-in on the sides of former F13.
- h. Cut the Stab Mount Blocks out of the printed balsa sheet. Make sure that these are cut out very accurately and that they match each other. Glue them in place on the fuselage, allowing them to stick out slightly past the already-tapered Side Stringers. When dry, shape the sides of the Blocks down to blend into the stringers. Remember to maintain a constant 3/8" width at the end of the fuse where the rudder will be hinged.
- i. Next you must prepare the die-cut plywood Tailwheel Mount (TWM) for installation on the bottom of the fuselage. Refer to the instructions on assembly of the Steerable Tailwheel Unit. Once you have the tailwheel assembled, hold it in position on plywood TWM and mark the hole locations for the 6-32 Mounting Bolts. Then epoxy the 6-32 Square Anchor Nuts to the top side of TWM. When dry, carefully inlet the bottom of the fuselage to accept TWM, and then glue it in place. Be careful not to get any glue in the threads of the anchor nuts.
- j. Shape the entire fuselage with a knife and sanding block to match the cross-sections. You will need to have the cowl at hand in order to get the shape of the nose area just right for a good cowl fit. Thus, refer below to the "Cowling" instructions and complete the cowl through step (6h.) at this time. Then come back and finish shaping the fuselage.

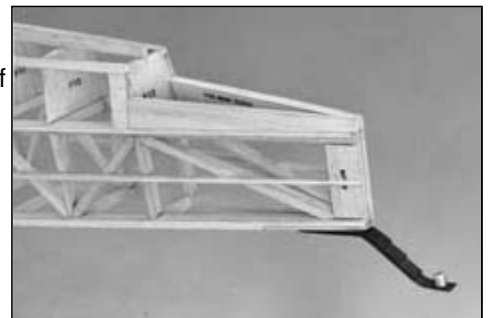
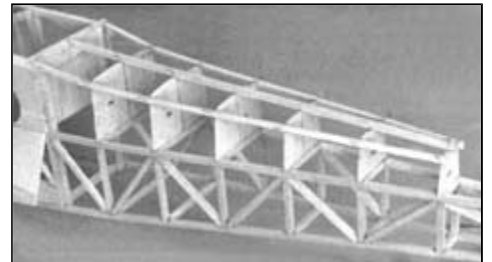

6. Cowling

- a. Lay the left cowl half on the Fuselage Side View plan and scribe a small mark on the outside of it with a knife to indicate the exact location of the thrust line. This mark won't be needed until after the cowl halves are joined, but it is much easier to mark it now while the cowl will sit flat on the plan.

- b. Butyrate dope thinner, MEK, or cyanoacrylate adhesive can be used to assemble the cowl. Hold the plastic joiner in place on the inside of one cowl half. Leave half of the joiner strip extending over the edge so as to lap onto the other cowl half when it is attached. Flow a few drops of adhesive under the edge of the strip. It will spread along the seam by capillary action. Squeeze and hold together any area of the strip that is not down tight against the cowl. Be careful not to let the adhesive get under your finger, it will leave a finger print that may be hard to remove.

Soldering Hint

When soldering a flat metal washer onto a wire part, it is very helpful to first slip a short piece of Sig Heat-Proof Silicone Fuel Line Tubing onto the wire and push it up tight against the washer to hold it in correct position for soldering (the following photo is not actually of the Cub's tailwheel assembly but does show a typical example of the method we're describing). The heat-proof tubing will not melt from the heat of soldering, and it will also keep excess solder from getting on the wrong side of the washer. After the solder cools, cut the fuel tubing off of the wire.



- c. After the joiner strip has dried in the first cowl half, hold the second half in place and carefully flow adhesive into the seam. Squeeze and hold together any areas of the seam that are open. Allow to dry thoroughly.
- d. Even up the back edge of the cowl with a sanding block.
- e. Due to its large size, the cowl needs to be strengthened by lining the inside with fiberglass cloth, stuck down with slow-drying epoxy glue or polyester glass resin. The first step is to sand the inside of the cowl with 80 grit garnet or similar grained sandpaper. Remove as much of the gloss from the plastic as possible. Don't worry about scratches in the plastic, a rough surface on the inside will help the cloth and glue stick better.
CAUTION: Never use sandpaper coarser than 220 grit on the outside of the cowl! It will cut deep scratches in the plastic that may open up wider when paint is applied. Refer to section "Sanding and Painting Plastic Parts", in section 20.
- f. Cut a piece of Sig Regular Weight Glass Cloth (SIGGF001, not supplied) that will cover approximately half of the inside of the cowl. The cloth is stretchy and will flow most of the contours of the cowl easily. Trial fit the piece of cloth inside the cowl without any glue to see if you can get it to lay down without any bad wrinkles. If you have had no experience in applying cloth before, you might consider doing the cowl in 3, or even 4, separate pieces of cloth and batches of glue. It will take a little longer that way, but you'll probably do a better job.
- g. Mix up a batch of glue large enough for the area you've decided to cover in one step. Brush the glue onto the inside of the cowl, putting on as smooth a coat as you can. Lay the cloth in place and pat down until it's well saturated with the glue. Smooth out the cloth, pulling out any wrinkles. When satisfied with the job, mix up another small batch of glue and apply the next piece of cloth. (Note: An alcohol soaked rag is handy for wiping excess epoxy off your hands or off the outside of the cowl.) After the entire inside of the cowl is covered, let dry thoroughly.



- h. When dry, trim off any excess cloth along the back edge of the cowl with a single edge razor blade or sharp X-Acto knife. If there are any big uneven spots or ridges inside the cowl, sand them down smooth so that they will not interfere with the fit of the cowl to the fuselage.

i. Scrape the seam on the outside of the cowl to take out any rough spots or flaws. Low spots in the seam can be filled with Sig Epoxolite putty. Don't put on too much Epoxolite and expect to sand away the excess later. Epoxolite dries very hard and must be worked into its final desired shape before it hardens. Use your finger or a single-edge razor blade, dipped in water, to smooth the Epoxolite into the low spots along the seam. Let dry overnight, then sand the entire cowl smooth and scratch free with fine sandpaper.

j. With a Dremel tool or X-Acto knife, cut an opening in the front of the cowl large enough for the engine's prop shaft and drive washer to fit through. Locate this hole according to the thrust line mark that you made on the cowl at the start of this section.

k. Cut out the two small air intake openings in the front of the cowl. Refer to the Fuselage Front View plan for the exact size and location.

l. A piece of 1/2"x1/2"x6" basswood is provided for making six equal 1" long Cowl Mount Blocks. After cutting them to length, epoxy the blocks in place on the front of the firewall, letting them stick out past the edge of the nose planking slightly. Mount the engine on the firewall. Slip the cowl over the engine and up to the Cowl Mount Blocks. Now you should be able to see where the blocks need to be taken down in order to fit properly inside the cowl. Use a sanding block to bevel and reshape the blocks as necessary until the cowl will slide back over the blocks and onto the fuselage.



m. Tape the cowl in correct alignment on the fuselage. Drill pilot holes for the Cowl Mount Screws (#4 sheet metal type, furnished) through the cowl and into the Cowl Mount Blocks at the same time. Take the cowl off and open up the holes in it large enough to pass the mounting screws. Then put the cowl back on and thread the mounting screws into the blocks.

n. Trim out the molded plastic Air Cleaner Cover to fit on the chin of the cowl. Leave a small flange around the edges for gluing. Hold the Cover in position on the cowl and draw around the outside of it with a pencil. Cut out the cowl plastic about 1/8" inside of the lines, so that cooling air will be able to flow through the Air Cleaner Cover and into the engine compartment. After this is done, glue the Cover in place and then cut open the front of it (within the framed area) with an X-Acto knife. This opening can be left wide open, or if you want a more scale appearance you can glue in a piece of plastic window screen (wait until after all painting is done).

o. Trim out the Right and Left Dummy Engine Cylinder moldings along the lines shown in the photo. Leave a small flange, about 1/16" to 1/8" wide, along the back of the part where it will match the curvature of the cowl. The best procedure for trimming is to rough out the part with a heavy-duty scissors or shears, and then finish the edges with a sanding block or Dremel tool. Next, carefully position the Right and Left Cylinders on the cowl using the plans and photos as a guide. Mark their location on the cowl with a pencil. Then carefully bond the cylinder moldings in place with dope thinner, MEK, or cyanoacrylate adhesive. Again, avoid getting adhesive on your fingers and making finger prints on the plastic.

p. Trim out the Right and Left Top Shrouds according to the trim lines molded into them. The trim lines are not very prominent. Holding the parts up to a light will make the lines more visible. You can trial fit the Top Shrouds onto the Cylinders at this time in order to fine-tune the fit of the trimmed edges, but it is best if they are not glued on permanently until after the Cylinders and Cowl are completely painted. The Top Shrouds can be painted after they are in place.



Engine Cooling Notes

The most important factor in cooling a fully cowled model engine is to keep a constant stream of fresh, cool air moving through the cowling. Large volumes of air aren't necessary, just a steady flow of new air. This is accomplished by having more exit area for the air than incoming area. Inadequate exit space can cause heated air to be trapped in the cowl, and this is what causes overheating and engine failure. Consequently, on our prototype models, we provided for additional exit space by

1. opening up the bottom of the cowl at the rear, and
2. cutting away the cowl plastic that is inside the dummy engine cylinders and then opening up the back of the cylinders themselves.

As an extra precaution, we also installed a baffle (made of sheet balsa) in the bottom of the cowl. It directs all of the air that comes in through the Air Cleaner Cover upward towards the engine cylinder before it can exit out the bottom opening in the cowl. With the setup described here, we have never experienced any overheating problems with glow engines from .60 to .90 cu. in. You may need to use a little ingenuity with some similar tricks to insure that your engine installation runs cool.

- q. Make any small openings or other provisions where necessary to allow access to the needle valve and for hooking up the glow plug.

7. Main Landing Gear

Assembly of the main gear requires the completed fuselage.

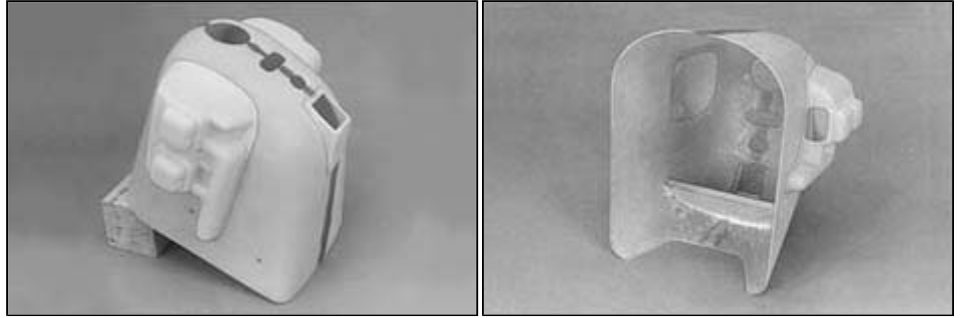

- a. Place the 3/16" Main Gear wire and the 3/16" Rear Brace wire into the grooved L.G. Blocks in the bottom of the fuselage. Note on the plan that the Main Gear wire should be perpendicular to the bottom of the fuselage while the Rear Brace wire should be angled forward to meet it near the axle. You will have to trim the groove in the rear L.G. Block slightly to allow the Rear Brace wire to swing forward.
- b. Using the soft copper wire supplied, bind the ends of the two 3/16" wires together near the axle, along with the 1/8" dia. Bottom Shock Strut wire that goes between them. Use tape, clamps, or whatever you can come up with to help hold the three wires in alignment while you wrap them. If the wires don't line up exactly right with each other, rebend as necessary to get them to fit properly. Make the copper wire wrappings as tight as you can, with each strand of copper wire right next to the previous one. There should be no gaps between the strands of copper wire. Don't worry about running out of copper wire, as we have included extra to help insure that you can make these bindings very strong.

- c. When you have the wires bound together in proper alignment, solder them securely with normal rosin core solder. It is not necessary to have them brased or welded - just be sure to use a soldering iron or torch with enough heat output to get the wires and bindings hot enough for the solder to flow smoothly. Also, use plenty of soldering paste to help the solder flow completely around and thru the bindings. Protect the fuselage during the soldering operation with a cloth so that dripping solder or paste will not fall on the wood. After both axles are soldered and cooled off, carefully remove the wires from the grooved blocks.

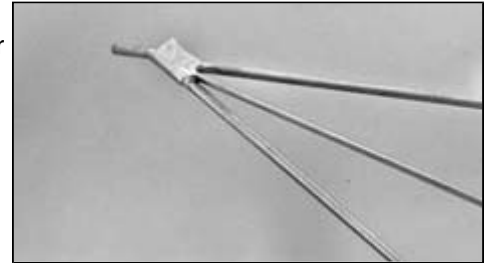

- d. Next bind and solder the 1/8" dia. Top Shock Strut wire in place at the top of the 3/16" Main Gear wire. Position this wire carefully before soldering - note in the front view on plan plate 4 that the middle bend of this Top Shock Strut wire should contact the middle bend of the Bottom Shock Strut wire so that they can later be bound together by rubber bands for flying. The rubber bands will serve as an effective shock absorber.

- e. After all the solder joints are cool, file and sand them to smooth out any prominent bulges in the bindings. Clean all joints with dope thinner or other suitable solvent.

- f. Cut a 1" long piece of wire, about 1/16" dia. or so, from left-over scrap pieces you undoubtedly have in your workshop. Form it into a shallow "V". Bind and solder it into the bottom of the Top Shock Strut. This serves as a hook for wrapping the rubber bands around both shock strut wires to as a shock absorber. You can see this scrap wire hook in the pictures under "Bungee Cover Simulations".

- g. A single sheet of 3/16"x6"x7" balsa is provided for fairing in the sides of the Main Gear. Cut out a right and a left fairing to fit between the 3/16" wires. Note proper grain direction on the plan. Epoxy the fairings in place and allow to dry.

Bungee Cover Simulations

Factory fresh J-3 Cubs had "leather boots" covering the bungee shock chords of the landing gear. Some recently restored J-3's have gone to airfoil shaped fiberglass or metal covers. You can easily simulate either type on your model.

Leather Boots: Cut two pieces of scrap balsa to approximately 3/4"x1"x2-1/2". Cut a groove halfway into each and epoxy them in place on the Bottom Shock Strut wire. Fill the groove with putty or epoxy glue. Carve and sand the balsa blocks to resemble the leather boots. Smear a thin coat of epoxy glue on the blocks. Sand smooth when dry. Finish as you do the rest of the landing gear.



Airfoil Covers: (See drawing on plan plate 4) Four molded plastic Bungee Cover halves are provided. Trim each out leaving a small flange around the outside. Notch the ends to fit over the L.G. wire. Groove 1/4"x 1/2"x2-1/2" balsa sticks and epoxy onto the wire. Shape the balsa pieces as needed to slip the Cover halves over them. When right, epoxy the Covers together and to the balsa and wire at the same time.



- h. For maximum strength, we recommend that you completely cover the balsa fairings with regular weight fiberglass cloth and slow-drying epoxy glue (applying it like you did on the inside of the cowl). Lap the cloth past the edges of the wood, completely around the 3/16" wires, and onto the back side of the fairings. Sand smooth when dry.
- i. Set the completed landing gear in place on the fuselage. The wires are to be held in the grooved blocks with the four Nylon Landing Gear Straps provided. Notice in the next photo that the straps should be installed all the way to the ends of the grooved blocks, right up against the wire where it exits the block. This is done to insure that the landing gear cannot shift sideways in a rough landing.



To install the straps, first mark the hole locations on the grooved blocks. Then use a 1/16" drill bit to drill a pilot hole in the blocks. Next screw the straps in place using the #4x1/2" Sheet Metal Screws provided.

8. Stabilizer And Elevators

Carefully cut all of the stabilizer "S" parts and the elevator "E" parts from the 3/8" printed balsa sheet #9. A jig saw works best for cutting these out. Cut just outside the lines, leaving all of the line on the parts. When fitting into place in the structure, use a sanding block to bring the edges of the parts to an exact fit. Cover the plan with waxed paper or plastic wrap. Pin all of the parts to the plan, gluing them to each other in the following order:

- a. Pin down the 3/8"x1/2" balsa stabilizer trailing edge.
- b. Add the 3/8"x1/2" balsa elevator leading edges and the 3/8" sq. spruce elevator joiner. Be careful not to glue these parts to the stab trailing edge while gluing them to each other.
- c. Fit in SI-A and SI-B.
- d. Add printed parts S2, S3, S4, S5, S6, S7 and S8.
- e. Fit in E1, E6, and the 3/8" basswood elevator horn insert.
- f. Add printed parts E2, E3, E4, E5, E7, E8, E9 and E10.
- g. Cut to length and glue in all 1/4"x3/8" balsa ribs.
- h. Add 1/8"x1/4" balsa braces where called for on the plan.
- i. When dry, unpin from the plan. Carve and sand all the outside edges round - remember the tail surfaces on the full-size Cub are constructed out of steel tubing, thus the leading and trailing edges are all perfectly round.
- j. Install the hinges where shown on the plan.

NOTE: Many modelers feel that the tail surfaces are easiest to cover before they are hinged. If you elect to do this, first test assemble the tail surfaces on their hinges without glue, to insure that a good edge and end match has been obtained in the sanding operation. Then refer to "Covering and Painting the Framework", section 19, and prepare all the tail surfaces (except the fin) through the point of covering and applying at least 2 coats of clear dope. After that, epoxy in the hinges permanently.

9. Fin And Rudder

The fin and rudder are assembled over the plan in the same manner as the stab and elevators were.

- a. Pin the 3/8"x1/2" balsa Fin Trailing Edge and Rudder Leading Edge to the plan. Do not glue to each other.
- b. Add R1 and R2 printed pieces.
- c. Shape and install the 3/8"x5/8" balsa Fin Leading Edge and Rudder Trailing Edge.

- d. Add R3 and R4 printed pieces.
- e. Shape and install the 3/8"x5/8" balsa Rudder Bottom.
- f. Cut to length and glue in all 1/4"x3/8" balsa ribs.
- g. Add RG-1, RG-2, and the 1/8"x1/4" balsa brace.
- h. When dry, unpin from the plan and sand the outside edges round.



- i. Inlet the bottom of the Rudder to accept the rudder horn. Epoxy the horn in place. Reinforce the installation with glass cloth and epoxy glue.
- j. Install the hinges where shown on the plan.



Here are two photos of Hazel's full-scale Clipped Wing Cub as it looked when it came out of the restoration shop in 1969.



WING CONSTRUCTION

IMPORTANT NOTE: The wing is basically constructed in three separate sections - a flat Center Section, a Right Wing Panel, and a Left Wing Panel. First you must construct the separate Right and Left Wing Panels by following all the instructions up the "Center Section" (12). Assemble each panel over its own full size plan.

10. Wing Panels

- a. Remove carefully all wing ribs from the die-cut sheets.
- b. Pin all WA, WI, W2, W3, W4 and W5 ribs together into one group for block sanding. Put 1/4" sq. sticks in the spar slots to help hold alignment of the stack. Sand lightly where needed to smooth up the stack. Don't forget to run the sanding block along the trailing edges, as shown here, to make them all the same length. Check the overall rib length against the Wing plan.
- c. Unpin all of the ribs except the WA, WI, W2, W3, and W4s. Leave them stacked together and drill a 3/16" diameter hole vertically through the rib stack in the location for the 1/16" wire aileron push rod to pass through (refer to the bellcrank wing cross-section drawing).
- d. Pin the two 1/4" sq. Spruce Bottom Spars in place on the plan.
- e. Pin the 1/4" sq. balsa Bottom Rear Spar in place. Note that this spar is doubled in height between ribs WI to W4.
- f. Pin all of the wing ribs securely in place. Use a triangle to make sure that they are perpendicular to the board.
- g. Add the 1/4" square Spruce Top Spars. Glue all joints securely!
- h. Glue in the 1/16" Spar Webbing where indicated on the plan. A single piece of 1/16"x4-1/8"x30" balsa is provided for making these. Note that the webs should be installed with the grain running vertically.
- i. Four pieces of 3/16"x4"x1-1/2" balsa are provided for making the Spar Webs that go in rib bays W1-W2 and W2-W3. The grain direction of these webs is also vertical.
- j. Glue on the 1/8" x 7/8" balsa Leading Edge.

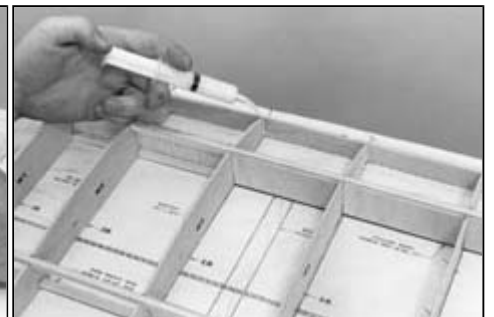
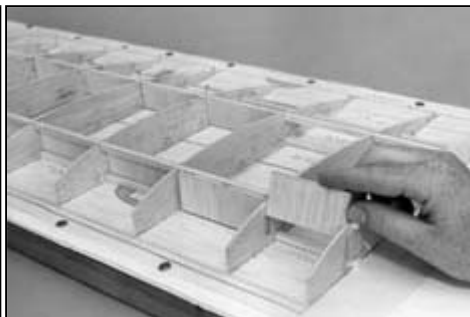
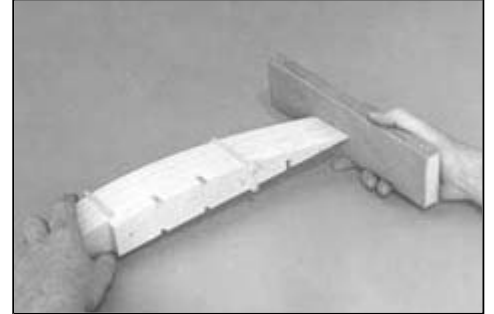

- k. When dry, unpin the wing from the board. Carefully sand the 1/8" Leading Edge flush with the bottom edges of the ribs.
- l. Glue on the 3/32"x3" balsa Bottom Leading Edge Sheeting. Be careful not to induce a twist or warp into the structure while pinning the sheeting in place.

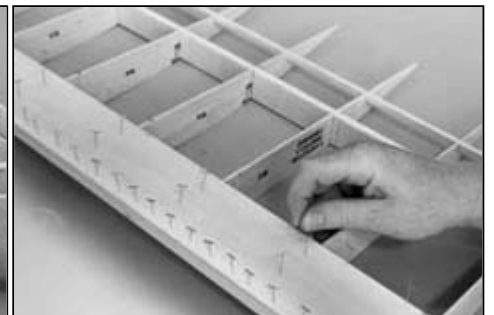
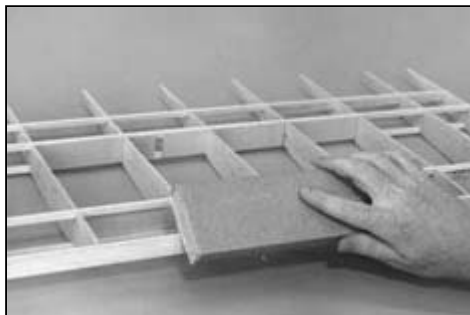

- m. Pin the 3/32"x1-1/2" balsa Bottom Trailing Edge Sheeting and 3/32"x1-1/2" Bottom Aileron Sheeting in place on the plan.

- n. Pin wing panel back in place on the plan, at the same time gluing it to the Bottom Trailing Edge and Aileron Sheeting.
- o. Add small riblet W3A. Be careful about exact location. Extend a line off of the die-cut slit in ribs W4 and W5 for alignment.
- p. Add die-cut plywood riblet W5A and balsa riblets W4A and W4B. Again be careful of exact positioning.

q. Cut to length and glue in place the 5/16"x1-1/8" balsa Tapered T.E. stock. Fill-In between the last two full length W4 ribs at the wingtip. Take down the top surface with a small sanding block until it's flush with the tops of the ribs.

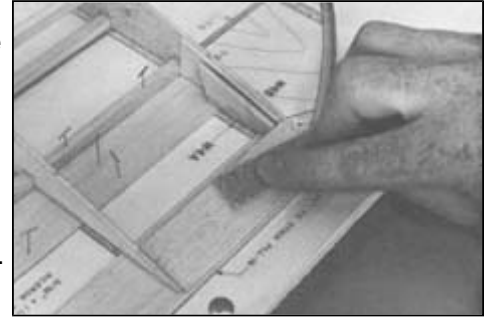

r. Glue on the 3/32"x1-1/2" balsa Top Trailing Edge Sheeting. Epoxy glue is recommended here for two reasons: First, it will have less tendency to bow or warp the trailing edge, than would a water-base glue. Second, it gives you plenty of time to get the top sheeting pinned down securely, absolutely flat on the board.

s. Add the 3/32"x1-1/2" balsa Top Aileron Sheeting. Check the location carefully with the aileron cross-section drawings.

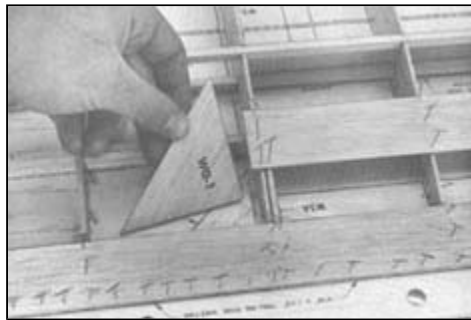

t. Glue gusset WG-1 in place against rib W3 and inside the trailing edge sheets.



u. Carve and sand the 1/8" Leading Edge flush with the tops of the ribs.

v. Glue and pin in place the 3/32"x3" balsa Top Leading Edge Sheeting. Also add the sheeting that goes over ribs W1 and W2 (cut from 3/32"x4"x36" stock).

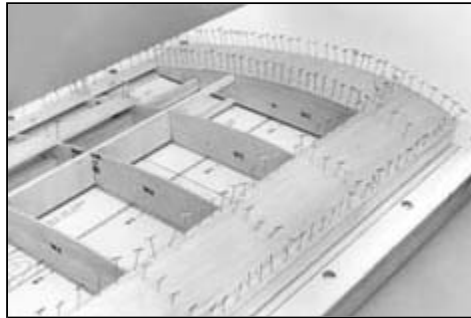

w. Cut to length and glue on all of the 3/32"x1/4" balsa Capstrips for the top of the wing.

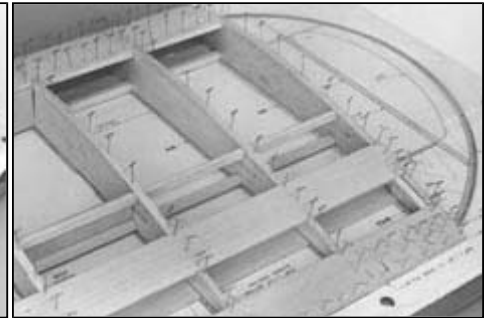

x. After the wing has thoroughly dried, unpin it from the board and install the die-cut plywood strut mounts FSM, RSM, and JSM on the bottom.

y. Sheet over the bottom of ribs W1 and W2 with 3/32" x 4" balsa. Leave a gap in the sheeting where the die-cut ply Rear Dihedral Brace goes. It will be installed later.

z. Add all of the bottom Capstrips.

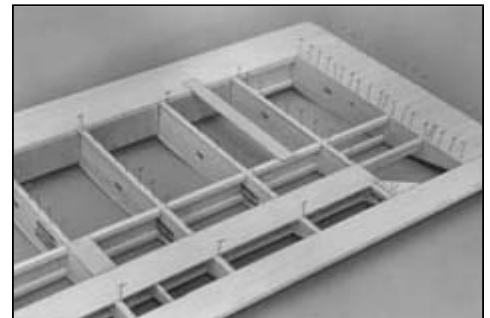

Do not block sand the wing panels yet!

11. Wing Tips

a. Glue die-cut balsa parts T-4, T-5, T-6 and W6 in place on the die-cut ply wingtip plate WTP.

- b. Study the Wingtip Alignment Drawing carefully in preparation for gluing the Tip Plate onto the end of the wing panel. Proper positioning of it against the W4 end rib is important for correct assembly of the rest of the wingtip parts in subsequent steps. First trial fit the Tip Plate assembly in place, noting that the tops of T-4 and T-5 should line up with the top of W4, not with the top of the capstrip. Also note that the front edge of WTP should be flush with the front of the 1/8" balsa Leading Edge. Use a straight edge to draw guidelines on the end rib to help line up the Tip Plate. Then glue it on.

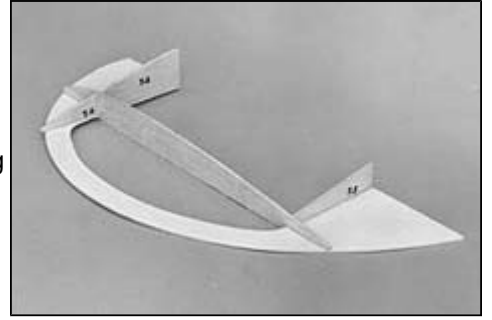

- c. Glue die-cut balsa parts T-1 and T-2 in place. Note that they should line up with the top and bottom edges of W4, leaving room for the 3/32" balsa top and bottom sheeting to be added later. Since W4 was stack sanded with the rest of the full-length wing ribs, and T-1 and T-2 were not, it may be necessary to alter the curved sides of T-1 and T-2 to exactly the same curvature as W4, before gluing them on.



- d. Glue on part T-3.
- e. 1/16"x3/4"x24" balsa strips are provided for laminating around the edges of the tip. Thanks to the large radius of the curve, it should not be necessary to soak the strips in water before laminating - thus Jet, Hot Stuff, or other cyanacrylate adhesives can be used. Carefully bend and glue the first strip to WTP. Add the other strips, one at a time, firmly gluing them to each other without gaps.
- f. When the laminated edge is dry, sand flush with the front of the wing panel and glue on the 3/8"x1" balsa Leading Edge Cap.

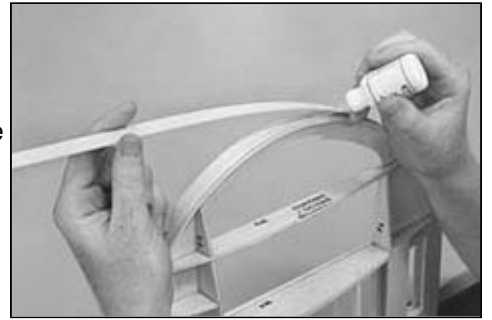

- g. Cut a small gusset, from scrap balsa, to go in the corner of the wingtip near the trailing edge. Glue on the top side of WTP only.
- h. Sheet the top and bottom of the Tip Leading Edge with 3/32" balsa.
- i. Capstrip the top and bottom of rib W6.

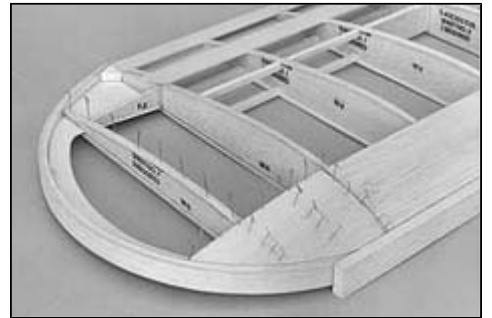

- j. Carve and sand the wing Leading Edge Cap and the tip laminated edge to shape. Study the photos and drawings carefully for guidance. Do not sand the rest of the wing, especially the top and bottom sheeting or capstrips, at this time - it's best to wait until the center section is done!



12. Center Section

Join the Right Wing Panel plan to the center Section/Left Wing Panel plan, along line X-Y. It is recommended that you have a building board at least 72" long for constructing the Center Section and joining the Wing Panels to it. Pin the plan to the board and cover the center section with waxed paper.

- a. Cut 3/32"x4" sheet balsa to cover the bottom of the Center Section. Pin in place on the plan, being careful not to let the ends of the sheeting extend past the side lines of the Center Section into the Wing Panel areas. Don't forget to cut the window opening! And leave a small gap in the sheeting where the ply Rear Dihedral Brace will be installed later.

- b. Cut to length a 1/4"x3/8" balsa stick and glue it onto the front edge of the bottom sheeting.
- c. Pin all the 1/4" sq. balsa bottom spars, the two center WA ribs, and the WSP pieces in place. After you get these parts squared up with each other, glue all the joints. When dry, sand the tops of the WSP pieces down flush with the tops of the ribs.
- d. Glue the 1/4"x7/8"x16" ply Front Dihedral Brace onto the front of the ribs and the 1/4"x3/8" stick. Use 5-minute epoxy. Make sure the Brace is centered spanwise so that it will extend an equal distance into the Right and Left Wing Panels.

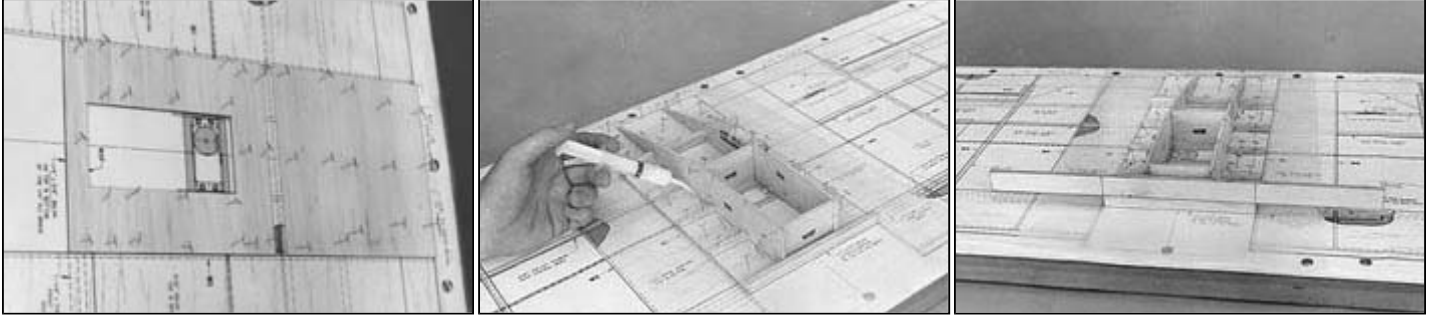

- e. In preparation for gluing the wing panels to the center section, first trial fit them without glue over the Front Dihedral Brace. Do this with the center section still pinned to the board. The panels should slide on smoothly until they are snug up against the center section bottom sheeting. The wingtips should be blocked up 1/2" at the last W4 rib for scale dihedral. Make any slight alterations where necessary to allow the wing panels to fit properly to the center section. When satisfied that the panels fit, glue them to the center section one at a time. Use slow-drying epoxy glue to allow yourself plenty of alignment time. Follow these steps:

1. First coat the back side of the Front Dihedral Brace with glue.
2. Use a wire to thoroughly coat with glue the surface of the 3/16" spar webs that the brace will bond to inside the wing panel.
3. Run a small bead of glue along the edge of the center section bottom sheeting.
4. Then slide the wing panel in place and pin securely.
5. Coat the adjoining WA rib with glue and pin it tightly against the panel's WI rib.
6. Attach the opposite wing panel using the same procedure. Then let the entire wing assembly dry before continuing.

- f. Glue in all 1/4" sq. balsa top spars.

- g. Add a 1/4"x 3/8" balsa stick on top of the Front Dihedral Brace, along the front of the WA ribs. Carve the excess down flush with the tops of the ribs.

- h. Fill in between the WA ribs, where the wing bolts will go through, with 5/16"x1-1/8" Tapered T.E. Stock. Carve or sand down flush with the tops of the ribs.

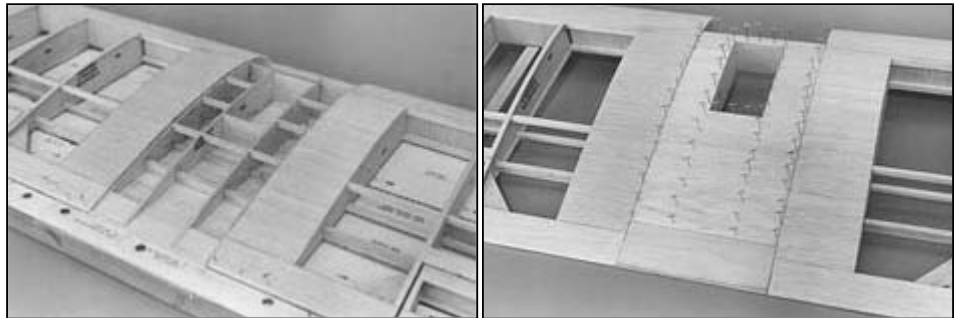

- i. Glue on the 3/32"x2"x6-1/4" plywood Center Section T.E. Top Sheet.

- j. Cover the top of the Center Section with 3/32"x4" sheet balsa. When dry, unpin the wing from the plan.

- k. Working through the opening you left in the bottom wing sheeting, use a razor saw to slot the WA,WI, and W2 ribs just in front of the rear spruce spars to accept the die-cut plywood Rear Dihedral Brace

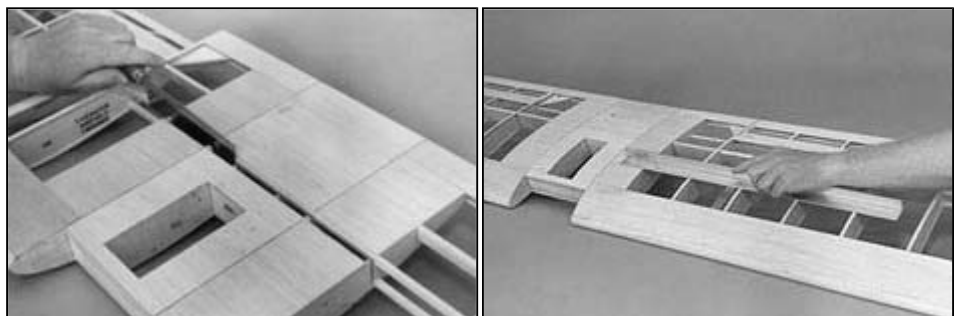

- l. Epoxy the Brace to the spars. Glue 3/32" sheet balsa in the gaps in the bottom sheeting.

- m. Carve and sand the trailing edges round. Carefully block sand the entire wing until all joints are smooth and even. Use as large a block as possible to avoid sanding down anyone area too much.

13. Cutting Out The Ailerons

- a. Locate the 1/4" sq. balsa Bottom Spar under the Top and Bottom Aileron Sheeting. Draw guidelines on both sheets about 1/32" behind the spar. Use a straight edge and a sharp knife to cut through the Aileron Sheeting along the guidelines. Make sure you are not cutting into the spar.
- b. Take an X-Acto razor saw and pry the crimped metal backing off of the blade with a screwdriver. Insert the saw blade into the slits just cut in the Aileron Sheeting and saw through each of the ribs of the aileron.
- c. Saw through the trailing edge and carefully remove the aileron.
- d. Trim and sand the back of the wing cutout until all ribs and planking are flush with the back of the balsa spar.



- e. Trim the aileron front in line with the rib angled die-cut slits. Use a sanding block to straighten the aileron front and ends.
- f. Glue 1/4"x1-1/2" balsa into the wing cutout and to the front of the aileron. Trim and sand these pieces to wing contour.
- g. With a razor saw, cut the base off one of the long nylon control horns that are supplied. Drill some random glue anchor holes in the top area of the horn.
- h. Inlet the bottom leading edge of the aileron to allow the nylon horn to be slid in place alongside the plywood riblet W5A. Refer to the aileron cross-section drawing to see how far in the horn should be installed. Hold the horn in position and drill a small pilot hole (for a #2x3/8" sheet metal screw) through one of the glue anchor holes and into the ply rib. Screw and epoxy the horn securely in place.

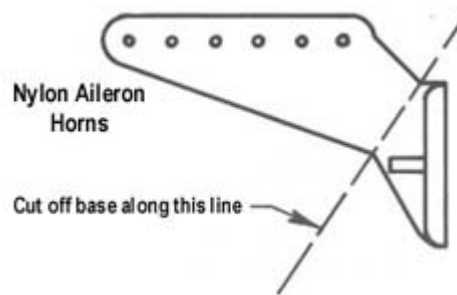
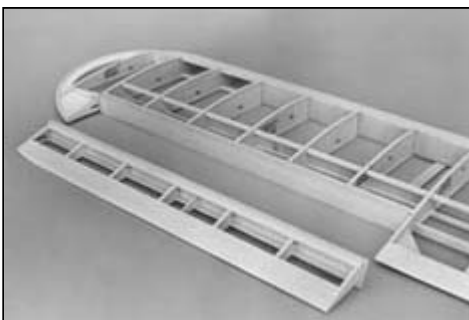

- i. Fill in behind the horn, on the bottom of the aileron, with 3/32" sheet balsa. Sand flush. This will give you somewhere to attach the covering material. If you wish to cover the ailerons before hinging, do it now.
- j. Cut slots in the aileron leading edge and the wing cutout to accept the nylon hinges. Use 4 hinges per aileron! Check the fit and movement of the aileron by dry fitting it into the wing first without any glue on the hinges. If there is any mismatch or binding, alter the slots as necessary to correct. Epoxy the hinges in. Repeat these steps to complete the other aileron.

14. Mating The Wing To The Fuselage

- a. Epoxy the 3/8"x1-1/2"x5-3/8" basswood Wing Bolt Block in place. Brace it to the lite-ply Cabin Bulkhead with 1" triangular balsa. Let dry.

- b. Set the wing on the fuselage, sliding it forward as far as possible. Mark and drill a 5/32"x5/16" hole in the wing's Front Dihedral Brace for the Cabin Wires to go through. The wing should then slide all the way forward with the trailing edge dropping down in front of the T.E Crosspiece. If necessary, adjust the hole slightly with a rat-tail file to eliminate any binding that keeps the wing from setting flat on the cabin.



- c. Tape or pin the wing in correct alignment with the fuselage measure from the wingtip to the back end of the fuselage. Determine the correct spots on the top of the wing to drill through and hit the Wing Bolt Block in the desired locations for the nylon bolts. Drill through the wing and Wing Bolt Block at the same time with a No.7 drill. Take the wing off and tap the Block with a 1/4-20 tap. Enlarge the holes in the wing to 1/4" diameter to pass the nylon bolts.

- d. Mark the locations for the 1/4" Dowels that go in former F5 (see cross-section F5). With the wing in place on the fuselage, drill 1/4" diameter holes completely through both F5 and the wing's Front Dihedral Brace at the same time. Remove the wing and epoxy the dowels in place in F5. Wipe any excess glue from the wing side of F5.

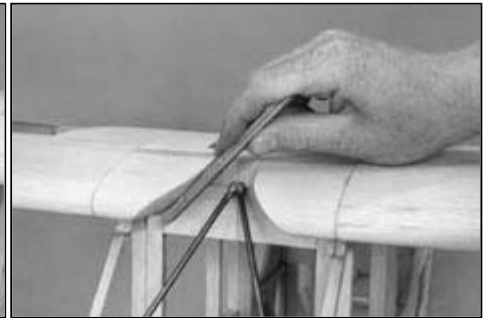

- e. 1-3/4"x2-1/4"x2-1/2" balsa blocks are supplied for making the Cabin Blocks. Study the Front, Top, and Side views of the Cabin Blocks on the fuselage plans. Trim the blocks supplied roughly to match these three viewpoints. Leave them slightly oversized. Then glue them in place on the front of former F5. Sand and trim to match the contour of the wing.

15. Wing Struts

Assembly of the wing struts requires the completed wing and fuselage.

- a. Locate the two 1/16"x1/2"x2" aluminum strips supplied for the Fuse Strut Fittings. Round all four corners of the strips with a file or grinder, and drill three holes through each with a #33 drill bit (see plan for exact locations). Draw a line across the middle of each strip. clamp it in a vise up to the line, and bend it to the angle shown.
- b. Mount the finished Fuse Strut Fittings in place on the bottom of the fuselage with 4-40 x 3/8" mounting bolts and blind nuts. Epoxy the blind nuts on the inside of the fuselage.
- c. Two pieces of 1/16"x1-3/16" (tapered) x 2" aluminum are supplied for making the Lower Strut Fittings. On each piece, round the corners of the narrow end and drill a #33 hole in the location shown on the plan. Also drill several random glue anchor holes along the sides where the spruce struts will be glued on.

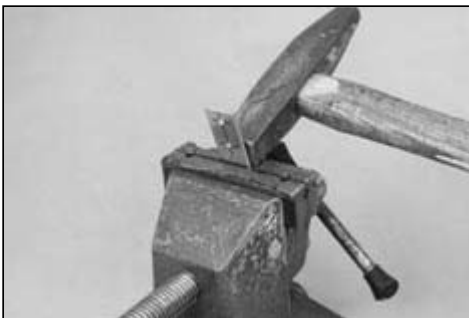

- d. Mark the four notched 1/4"x1/2" spruce struts as to which two are Front and which two are Rear - there is a difference in length (see plan). Taper the fuselage end of each Rear Strut so it will fit onto the brass Lower Fitting along with the Front Strut. Epoxy one Front and one Rear Strut onto each of the aluminum Lower Strut Fittings - make two identical assemblies. Work directly over the Wing Strut plan to insure that the angle between the struts will be correct.

(NOTE: At this point, there is no "right" or "left" difference between the two wing strut assemblies, as is called for on the plan.)

- e. Four pieces of 1/16"x1/2"x2-1/4" aluminum are provided for making the Upper Strut Fittings. Drill, shape, and bend these pieces as shown on the plan to make two #1 and two #2 Upper Strut Fittings. (The difference between the finished right and left wing strut assemblies will be in these Upper Strut Fittings. That's why they are called #1 and #2 on the plan - notice that the slant of their bend lines go in opposite directions.)

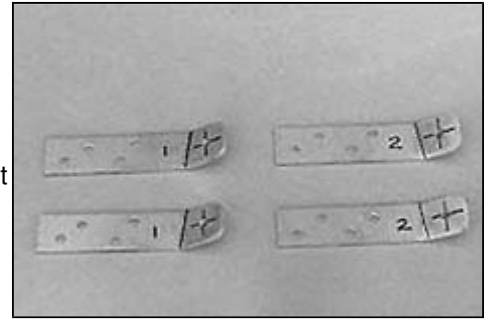

- f. Bolt the wing in place on the fuselage. Fasten the wing strut assemblies in position, one on each side of the fuse, by bolting the Lower Strut Fittings to the Fuse Strut Fittings. Make sure you have the shorter front strut of each assembly facing the front of the airplane. Trial fit, without glue, the finished Upper Strut Fittings into the notches in the spruce Struts as follows:

RIGHT WING STRUT ASSEMBLY - A #2 Upper Strut Fitting goes in the Front Spruce Strut
A #1 Upper Strut Fitting goes in the Rear Spruce Strut

LEFT WING STRUT ASSEMBLY - A #1 Upper Strut Fitting goes in the Front Spruce Strut
A #2 Upper Strut Fitting goes in the Rear Spruce Strut

Check that the Upper Fittings mate smoothly to their ply mounting inserts (FSM and RSM) that are built into the wing. If they don't, double check to see that you've got the correct Upper Fitting in the correct strut. You may also have to readjust the bend angles of the Upper Fittings and/or Fuse Fittings slightly to get a good fit. When satisfied, take the struts off the model and epoxy the Upper Fittings into their proper notches.

- g. When dry, bolt the strut assemblies back on the model. Hold the Upper Fittings up against the bottom of the wing and mark the locations for the 4-40 mounting bolts onto the ply mounting insert FSM and RSM. Take the struts back off. Drill holes through the ply inserts and epoxy 4-40 blind nuts in from the inside (you'll have to make a small opening in the front spar webbing to get the front blind nuts in).

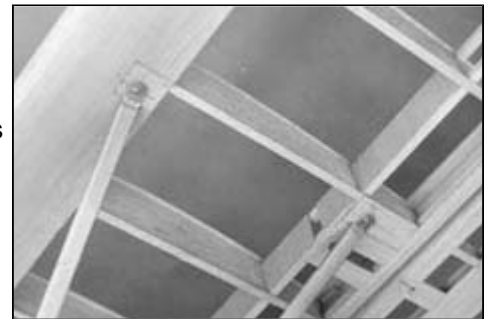

- h. Carve and sand the edges of the struts round. See cross-section on strut plan.

- i. Reinforce the ends of the spruce struts over the brass fittings with a layer of fiberglass cloth and epoxy glue. Also cover the areas in the center of each strut where the jury struts will go. When dry, sand smooth.

- j. Install 4-40 blind nuts in the ply Jury Strut Mount inserts (JSM) that are built into the wing. Epoxy the blind nuts in the exact locations shown on the plan.

- k. Four pieces of 3/16" o.d. x 7" long brass tubing are provided for making the Front and Rear Jury Struts. There are patterns and instructions on the plan to use as a guide for bending them to shape. A regular hand pliers works best for flattening and bending the ends of the tubing. Try to bend them exactly along the lines drawn, but don't make the bends too sharp or the tubing could crack.

- l. Bolt the top ends of the finished Front and Rear Jury Struts to the wing. Swing the bottom ends in position to line up with the spruce struts. (Be careful not to bow the spruce struts out of shape - make the brass jury struts meet the spruce!) Mark and drill the holes for the 4-40 flat head bolts that secure the bottom ends to the spruce struts. Countersink the holes so that the heads of the bolts are flush with the bottom of the spruce struts.

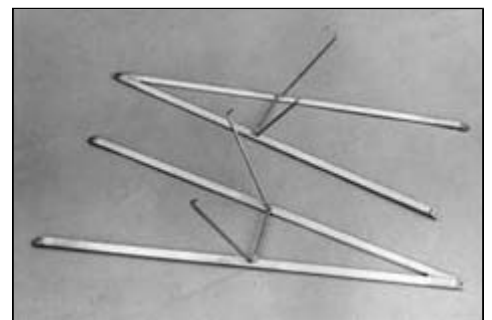

- m. Cut to length, flatten and drill the ends of the two 4" long pieces of brass tubing provided for the Bottom Jury Struts. Due to small differences between models, it's impossible to give you a useable pattern for these pieces. You'll have to tailor them to fit on your own model.

- n. Make a final assembly of all the strut pieces to the model. During the assembly epoxy the flat head bolts into the spruce struts; epoxy together the lower ends of the Jury Struts where they overlap; and epoxy on the 4-40 hex nuts that hold them all together. Let dry before taking off the model.

16. Attaching The Tail Surfaces

If you've precovered the stabilizer, remove the covering material from the bottom center area where it will contact the fuselage.

- a. With the wings mounted to the fuselage, pin the hinged stab/elevator assembly in place. Note that the fuse will need to be trimmed slightly under the elevator joiner to permit adequate movement of the elevators. Carefully align the stab with the wings from the top and front views. Mark the location of the fuse on the top and bottom of the stab center section. Remove the stab and apply epoxy glue. Slow drying epoxy (not 5-minute) is recommended to allow adequate time to get the stab in exact alignment before the glue hardens. Pin the stab back in place using the markings to get it in approximate alignment. Before the glue hardens, recheck the alignment carefully by measurement and shift the stab position slightly if necessary.
- b. Epoxy the hinged fin/rudder assembly in place, installing the bottom hinge into the rear of the fuselage at the same time. Align carefully.
- c. Glue the die-cut 1/8" balsa Tail Fairings in place. They should be flush with the fuselage sides at the stab leading edge and touching the fin at the back.

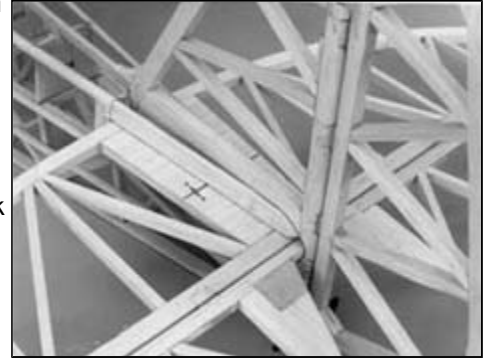

FINISHING

17. Radio Installation

It's best to mount all your radio equipment and pushrods before covering and painting, while you still have easy access inside the model. Once the initial installation has been made and all the bugs are worked out, you can take the radio system back out while the painting is being done.

In spite of some of the things you may have heard or read, putting a radio in your 1/4-scale Cub need not be much different than for a smaller model. This section describes the control system installations that have worked best in our prototype Cubs and that we recommend. Except for the use of some "heavy-duty" parts, you'll find that the installation is pretty straight forward. As with any size model, the QUALITY of the installation more than anything else will determine how well it flies the model.

Always double check all control hookups! Locate the source of any binding, rubbing, or sticking and eliminate it.

No radio gear or servo mounting materials are supplied in this kit. Any other parts called for in the instructions that we do not furnish are marked with an (*).

Elevator And Rudder Hookup

The elevator and rudder are each actuated by one "heavy-duty" servo. Almost every radio manufacturer produces heavy-duty servos specifically designed to handle the increased control surface weights and air loads of 1/4-scale models. Standard size servos (35 oz./in. torque or less) are not recommended for the elevator or rudder of the Cub. If in doubt about the ability of the servos you have to handle the job, consult the manufacturer of the radio gear.

The most convenient method of installing servos in the fuselage is on the plastic mounts (*) that are offered by most radio manufacturer for their equipment. These are screwed to hardwood mounting rails (*) that are epoxied across the inside of the cabin area. Mount your servos anywhere between formers F5 and F6. Further instructions on the use of servo trays are usually included with them.

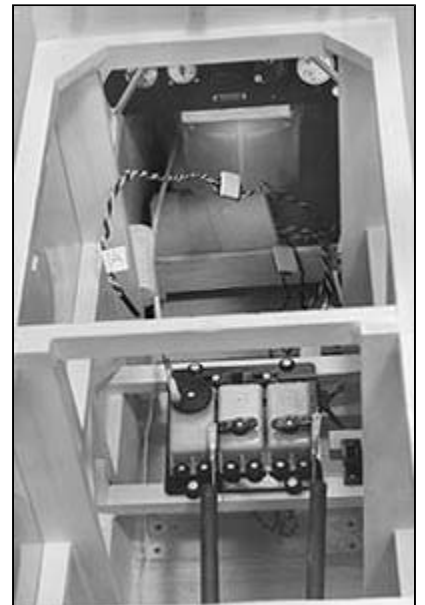

A long nylon control horn is supplied for the elevator. Install it on the bottom of the left elevator with #2x3/4" sheet metal screws. Once installed, cut off the excess ends of the screws flush with the top of the nylon retainer plate.

Pushrod Assembly

Materials are supplied for building fiberglass pushrods to link the elevator and rudder servos to their control horns. Make the control surface ends of the pushrods first.

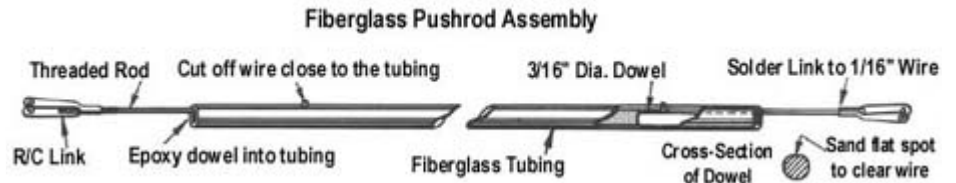

Put a 90° bend in the unthreaded end of the 4-40x8" threaded rod. Drill a 3/32" diameter hole 2" from the end of the fiberglass pushrod tube. Slide the 4-40 rod into the tube, sticking the 90° bend through the hole.

Sand a flat spot on one side of the 3/16"x2-1/2" dowel until it can be squeezed into the tube alongside the 4-40 rod. When you get the fit right, final assemble the parts into the tubes with epoxy glue. It should not be necessary to put any bends in the 4-40 wires of either the elevator or rudder pushrod to get them to feed through the fuselage and hook up to the control horns. It's a pretty straight shot if your servos are positioned side by side as shown in a previous photo. However you may have to trim out a portion of the diagonal 5/16" sq. main frame balsa under the stab to clear the elevator pushrod wire.

Assemble the servo ends of both pushrods in the same fashion, only use 1/16" dia. x 8" music wire and solder links instead of the 4-40 size hardware. After you've got the 1/16" wires and dowels epoxyed into the tubes, feed the pushrods back into the fuselage and hook up to the control surfaces. Center the 4-40 links on the threads at the tail end. Then measure and cut off the 1/16" wires at the front, to the length which will allow the solder links to reach the servo arms. Protect the servos with a rag while soldering the links onto the ends of the wires.

Your elevator and rudder pushrods should now be complete and operating freely. Fill in around the 4-40 pushrod wires where they exit the fuselage with scrap sheet balsa, glued in flush with the stringers.

Brace the pushrods in the middle (near former F9) with 1/4" sq. scrap balsa to eliminate any possibility of in-flight vibration or bowing problems. Criss-cross pieces of 1/4" sq. stick on all four sides of each push rod. Glue them to the 5/16" sq. main frame balsa. Have the braces touching the pushrods, but not creating a bind.

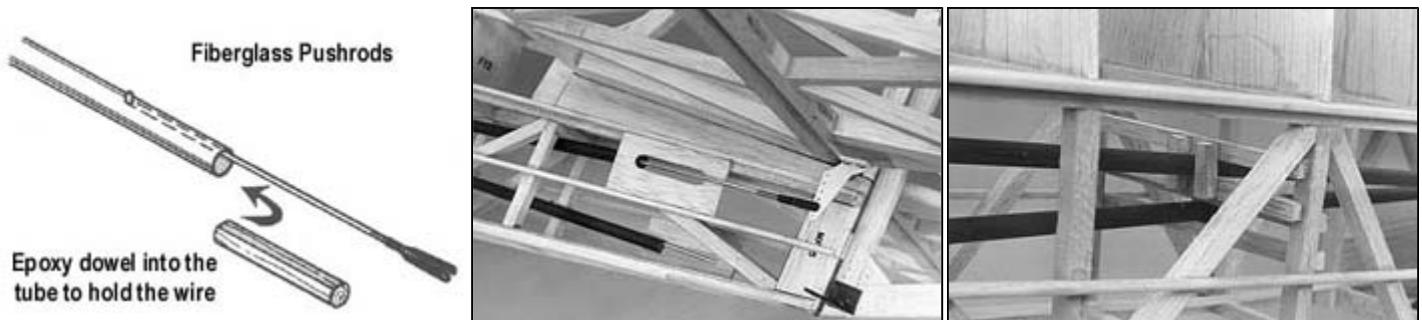

Throttle Hookup

Either a standard or heavy-duty servo can be used for the throttle control on a .60 to .90 glow engine. A flexible steel cable pushrod with nylon outer tubing (*, such as SIGSH559) is best for hookup of the throttle servo to the carburetor. Follow the assembly instructions on the pushrod package.

Battery Pack

Due to the larger than normal battery drain from using heavy-duty servos, a 1000 mah receiver battery pack (*) is recommended. Wrap the battery pack in foam rubber (*, such as SIGRF240) held on with rubber bands or masking tape, to protect it from engine vibration. Secure it as far forward as possible in the nose under the fuel tank.



Receiver

The receiver should also be wrapped in foam rubber and stowed as far forward as possible. Make certain that it is somehow fastened in place so it will not move around during flight. A 36" long piece of large (3/16" o.d. approx.) nylon tubing is provided for making an internal antenna mount. Glue the tube in a bottom corner of the fuselage, from the cabin area back to the tail, and slide the antenna wire into it.

Switch

The receiver on/off switch may be mounted wherever it is convenient. Some servo trays have a slot along the front for holding the switch. Then run a short length of music wire (*) from the switch to the outside of the model.

Aileron Hookup

One heavy-duty servo, such as recommended for the elevator and rudder, can safely operate both ailerons at the same time from the center of the wing through the use of 90° aileron bellcranks. The full size wing plan shows the servo mounting, bellcranks, and pushrods in place in the wing. The importance of making the installation operate perfectly smooth and friction free can't be over emphasized. A heavy-duty 1/4-scale servo is more than strong enough to handle the flight loads of both ailerons if its power isn't being robbed by a balky bellcrank installation. There is no room for sloppiness or mismatched assembly. With a little patience and forethought, your installation can be dependable and trouble free.

Two pieces of 3/32"x2-1/2"x4-1/8" plywood are provided for the bellcrank mounts. Do not glue them into the wing at this time! First assemble the bellcranks onto the ply mounts as shown here. Locate the holes for the music wire pivots according to the wing plan drawing.

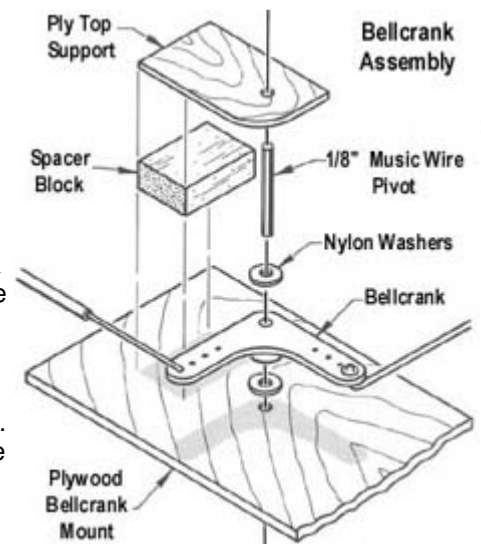

Be sure to make a right and a left bellcrank assembly. Sand the balsa spacer blocks down until the bellcranks and washers just fit between the ply pieces with a minimum of clearance. Do not sand the blocks too small and put a bind in the bellcrank movement. Epoxy the spacer blocks and top ply supports to the ply mounts. Slip the bellcranks and washers in place and epoxy the music wire pivots to the ply pieces. Make sure the bellcranks operate freely up to this point.

A 36" long piece of small (1/8" o.d. approx.) nylon tubing is provided. Cut it into two 18" long pieces and slide these into the holes you drilled into the wing ribs during the wing panel construction. Slide the 1/16" dia. music wire pushrods inside the nylon tubes. Check for any binding that may be caused by slight misalignment of the holes. Then epoxy the nylon tube to all the ribs except for the W1s and WAs in the center section.

Pull the 1/16" pushrod wires out and make a "Z" bend in the end of each. Trial fit them and the bellcrank assemblies in the wing to check that the "Z" bends don't bind on the bellcranks.

Bend the 4-40 x 8" threaded rods to the shape shown in the wing cross-section drawing. Trial fit them into the control system and check again for binding. Fasten the enthreaded ends of the rods to the bellcranks with a "Z" bend, or by bending 90° and soldering on a small washer (*). Only after you've got the entire aileron control linkage assembled and operating freely should you glue the ply bellcrank mount platforms to the wing ribs.

The aileron servo can be mounted in the center section and linked to the 1/16" pushrod wires several ways. You may have your own favorite method. The following two photos show different installations which vary only in the brand of servo used and the positioning of it in the center section window.

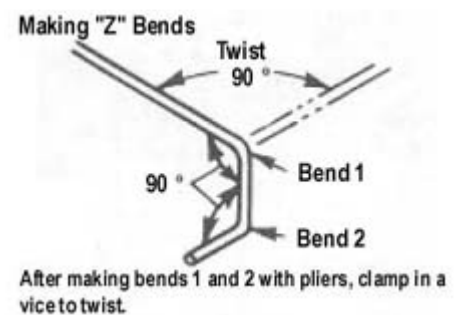

The first photo shows a Kraft KPS-20H servo mounted vertically into the window from the bottom of the wing. The photo was taken looking through the top window and is the same installation that is drawn on Plate 3 of the full size plans. The second photo shows an Airtronics 94554 servo flat mounted onto a piece of plywood that was glued into the window opening. In both installations, the right and left 1/16" pushrod wires have been spliced together with a piece of 1/16" i.d. brass tubing (*). Then a 1/16" spur wire (*) must be bent to link the pushrods to the servo arm. Wrap and solder the spur wire onto the pushrods. You'll probably find that the holes in the two center WA wing ribs will need to be oblonged slightly to allow the pushrods to flex with the rotary motion of the servo without binding.

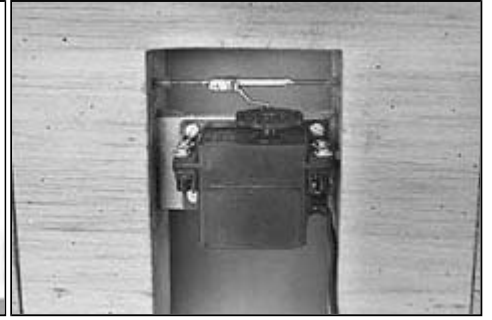

Optional Aileron Hookup

(* No materials are supplied for this option.)

Some 1/4-scale flyers prefer to use two separate servos to operate the ailerons. We have tried this method (see photo) and can recommend it if you want to go to the expense of buying an extra servo. It's actually easier to hook up than the one servobellcrank method. Mount the servos in the same rib bays where the bellcranks would be. Build a removable hatch between the ribs so you can get at the servos when necessary. Use long extension cords and a "Y" junction cord to link the servos to the receiver. Consult your radio manufacturer about the need and availability of "chokes" to eliminate any possible radio interference from the long extension wires.

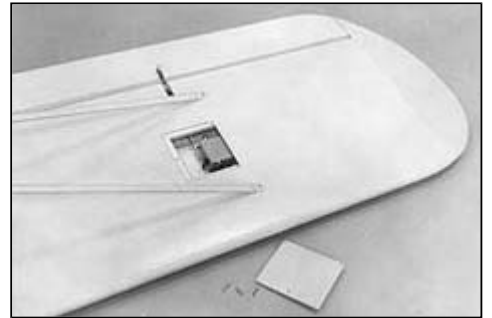

18. Tips On Tanks

A 16 oz. rectangular plastic clunk tank is recommended for use with most all .60 to .90 cu. in. glow engines. Refer to the engine manufacturer's instructions for any special notes they may have on fuel tank or pump/pressure requirements for your particular engine.

The simplest, most trouble free, tank set-up to use with a fully cowled in engine is normal suction feed, without any pump or crankcase pressure. If you can run your engine on suction, assemble the fuel tank hardware as shown in the photo. There are 3 tubes installed through the rubber stopper - 1 for fuel feed, and 2 for vents. Both vent tubes should curve upwards inside the tank. The clunk line on the fuel feed tube must swing freely without hitting the back of the tank. (If your tank, as supplied, does not come with silicone tubing for the internal fuel feed line, substitute a piece of Sig Heat-Proof Silicone Tubing, SIGSH290 Large. With it installed, the tank can be left in the fuselage indefinitely since this line will not harden or deteriorate when immersed in raw fuel.)

With an inverted engine installation, the tank will be correctly located for proper fuel draw and idle characteristics if it is mounted onto the bottom of the ply Nose Joiner. Simply glue four J-Bolts (SIGSH123, not supplied) into the bottom of the NoseJoiner, and use rubber bands hooked between them to hold the tank in place, as shown.

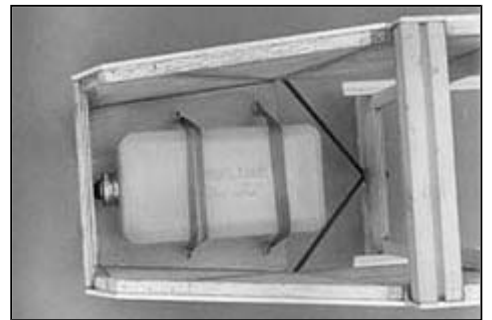
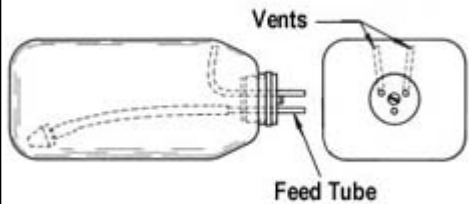

Drill holes through the firewall large enough to pass the fuel lines through. Once the tank is installed permanently, after painting the model, seal the holes in the firewall against leakage of the exhaust oil into the fuselage with silicone rubber sealer. Run fuel tubing from both vents downward and out the bottom of the cowl at the back. Connect the fuel feed line to the carburetor. To refuel, simply pump fuel into either of the vent lines until it runs out the other. Then plug one of the vents with a short 4-40 bolt to keep the fuel from siphoning out. It's not necessary to remove the feed line from the carb to refuel.

19. Covering And Painting The Framework

The completed Cub framework can be covered with Sig Koverall, Sig Silk or an iron-on type of covering material (either plastic or fabric). Whatever type of covering you desire to use, it will not conceal a rough framework. Be sure all surfaces are smooth before proceeding!

The manufacturer's directions for applying iron-on coverings are packed with the material. Follow these closely, for different types of material have different iron temperatures and techniques of application. The rest of these instructions describe the use of Sig Koverall, which is a polyester based synthetic fabric ideally suited to quarter-scale models due to its low cost, workability, and toughness. Silk is applied in the same way, but it costs much more per yard. Koverall is highly recommended for the Cub - all of our prototype models were covered with it.

Brush an unthinned coat of clear Sig Supercoat or Sig Lite-Coat Dope over all parts of the framework that will contact the covering. When dry, resand with fine sandpaper to remove any fuzz or raised grain. Brush on a second coat and sand again.

The bottom of the wing is a good place to start covering. Cut a piece of Koverall about 1/2" larger all around than half of the wing, with the grain running lengthwise. (The grain of woven materials run parallel to the finished bias edge.) Dip the piece of covering in water, let the excess water run off, and then lay it on the wing. Go around the edges, pulling out the wrinkles and stretching the material smooth. Brush clear dope around the edges. This will soak through the fabric and adhere it to the dope already dried into the framework. Let dry before trimming off the excess material with a sharp razor blade. Check for any rough areas or places that are not stuck down properly and apply more dope.

Use the same process to cover the top of the wing, the fuselage, and the tail surfaces. Be sure to read "Hints on Covering the Fin Fillet".

After all covering is done, allow the water to dry out of the fabric and wood. If the Koverall is slack or baggy in any places, use a hot air gun or hair dryer to shrink it tight (read Koverall package instructions).

Next give the entire model a coat of Lite-Coat clear dope. Thin the dope until it brushes on easily and flows out smoothly. Brush the dope on sparingly over the open framework areas. If too much is applied, the excess dope may rub off the brush, run completely through the covering and puddle against the covering surface on the other side.

Hints On Covering The Fin Fillet

On the full-size Piper Cubs, the fuselage and fin are covered with one continuous piece of fabric. It bridges from the top stringers of the fuselage sides up to the fin bottom rib, producing a beautiful fillet.

The construction of this model Cub duplicates this feature. Your covering material should bridge from the sheet balsa Tail Fairings up to the fin bottom rib. This may at first appear to be a difficult job to do, but it's much easier than you'd think.

If you're using a dope-on type covering, proceed as follows:

1. Cut a piece of material that will cover the entire left side of the fin and left side of the fuselage top (all the way forward to the wing T. E. Crosspiece).
2. Dope the edges of the covering down along the fuse 3/16" x 3/8" Top Stringer, the 1/4" sq. Corner Stringer, and the T.E. Crosspiece. Pull out any large wrinkles or sags in the fabric.
3. Straighten out the rear end of the covering and adhere the bottom of it to the Tail Fairing. Work the material smooth and dope it down to R4 and the fin bottom rib. Use plenty of pins to hold securely until dry.
4. Apply three extra coats of clear dope along the fabric stuck to the fin bottom rib. Let dry between coats.
5. Finish sticking down the remainder of the covering piece at the top of the fin.
6. Now repeat the steps to cover the right side of the fin and the fuselage top in the same manner.

When dry, resume following the rest of the written instructions for doped-on coverings. Be careful when applying the pre-color clear dope coats over the entire model that you don't soften the bond of the fabric to the bottom rib and let it pop loose. It's best not to put any dope of the fin bottom rib while painting the surrounding fin and fillet areas.

If you're using an iron-on type of covering, apply it basically the same as described above with one exception. Lap and adhere the fillet covering piece over onto the top side of the fin bottom rib and cut it off there. Then, after shrinking the fillet area tight, cover the top part of the fin with a separate piece. Overlap it slightly onto the fillet covering. If you try to do the job in one piece, the heat of shrinking the entire area will always pop the covering loose from the fin rib.

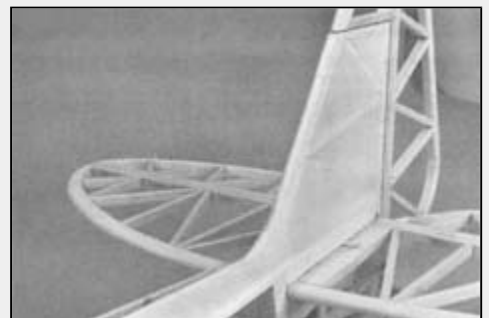
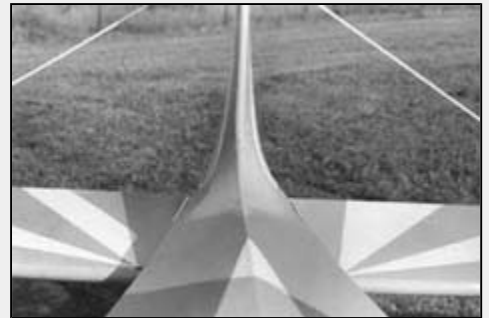

When these puddles dry, the large amounts of dope solids in them cause more shrinkage than in the rest of the covering and a scarred area results. So apply dope very lightly the first time over. The second coat will seal most of the pores of the Koverall, and from that point running through will not be a serious problem.

You can put anywhere from 3 to 5 total coats of clear dope on the Koverall before going to color. It depends somewhat upon how heavy a coat you are putting on. Keep the dope thinned out enough to flow on smoothly. Sand well between the later coats of dope with 220 grit Tri-Mlite paper. Don't bear down on the edges of the balsa structure or the fabric may be cut. Use your own judgement about when you've put on enough coats. The goal is a completely smooth and even base for the color paint. Keep in mind that weight can build up fast in finishing and restraint must be used in application. Don't try to completely fill the grain of the fabric like you would on a smaller model. The weave will not be very noticeable as long as the edges are smooth - it may even look more realistic. Sanding sealer or primer is not necessary or advisable.

Best results can usually be obtained by spraying on the color finish coats. It is also much faster than brushing would be on this large a model. Reduce the dope for spraying fifty-fifty with Sig Supercoat Thinner. Two coats of your base color should give good coverage if the surface preparation was sufficient. If any light sanding between base color coats is needed, use 360 Tri-M-lte or 400 or finer wet paper.

When the base color has dried, mask off the edges of the color trim areas with "drafting tape" (3M Scotch brand is available at most office and art supply stores). Completely cover with paper and tape all areas that should remain base color. Brush or spray the edges of the tape with clear dope. This seals the tape, preventing leakage of the trim color underneath the tape. Spray on two coats of trim paint. When dry, carefully remove the tape.

Complete the job by spraying a coat of Lite-Coat clear dope over the entire color scheme to protect the colors from scuffing and to give the entire model a uniform gloss.

For best results, it is not a good idea to try to mix different brands of paint. Use SIG products from the start.

Bottom View Color Scheme

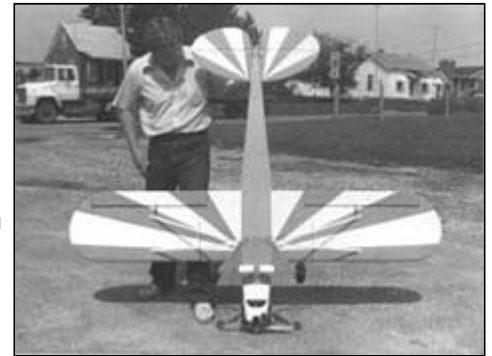

20. Sanding And Painting The Plastic Parts

CAUTION: Do not try to cover any of the plastic parts with Monokote, Coverite, or other iron-on types of covering material. The heat can damage the plastic parts.

The cowling, dummy engine, and bungee covers are molded out of ABS plastic. We recommend that they be painted with Sig Supercoat Dope for a good color match to the rest of the doped model. Hobbypoxy, K & B Superpoxy, and Dulux Enamel have also been proven compatible with the plastic. Do not use other paints, dopes, or finishes without first testing on scrap plastic to make certain that they are compatible.

In preparation for painting, the plastic parts should be sanded to remove as much of the surface gloss on them as possible. Do not use coarse sandpaper which will cut deeply into the plastic. Deep scratches will often open up wider during painting. Use 220 grit or finer 3M Tri-M-lte Fre-Cut Finishing Paper (see Sig Catalog) or its equivalent.

Color paint can be put directly on the sanded plastic. Primer type coats are not necessary if a thorough sanding job was done with fine paper. Brush or spray the color paint onto the plastic parts. Do not apply heavy, wet coats which can cause an "orange peel" effect. Put on light coats and allow them to dry before applying a second coat.



The "stand way off scale" detailing of the dummy engines on our prototype models was done by painting with 3 basic colors:

Silver for the cylinder heads and the outside of the top shrouds.

Black for the inside of the top shrouds, the cylinder fins, and for any recessed or shadowy areas.

Steel for the exhaust pipes and the cylinders. This isn't a standard color, you'll have to mix your own by slowly adding black paint to silver until you get the shade you want. It shouldn't be too light colored, but must provide adequate contrast with the black painted area.

The silver painted areas should be glossy when dry. The black and steel areas should be flat, non-glossy.

21. Painting The Landing Gear And Wing Struts

The completed landing gear and wing struts should be painted with epoxy type paint (Hobbyepoxy or K & B Superpoxy) because of the large amounts of metal to be painted. Dopes do not stick well to metal, but epoxy paint does.

Brush or spray a coat of epoxy primer on the entire part and sand smooth when dry. Repeat applications of primer and thorough sanding until the surface of the wooden and fiberglassed areas are smooth.

Spray on two coats of color, letting dry between coats.



22. Self-Adhesive Decals

Cut out the decal you wish to apply with a sharp scissors, modeling knife, or single-edge razor blade. Trim close to the image, leaving about 1/32" to 1/16" of clear edge around the decal. Smaller designs (2 - 3 sq. in. or less) can be put on the model by "dry application", whereas larger decals go on easier using the "wet application" instructions.

Instructions for Dry Application

Peel the paper backing sheet completely off the decal, being careful not to let the sticky side double over and adhere to itself. Hold the decal in position just above the surface of the model while you double check to make certain it is exactly where you want it. Don't let the decal contact the surface of the model until you are sure of its location! Once it is stuck down, it can't be moved! Start the actual application by pressing just one edge of the decal into contact with the surface of the model, and then carefully work towards the opposite edge, slowly rubbing the remainder of the decal in place. Be careful not to trap air under the decal. If air is trapped under the surface, puncture the air bubble with a pin and press down.



Instructions for Wet Application

Here's a little trick that allows application of self-adhesive decals to a model without the danger of trapping air bubbles. Start by wetting the surface of the model where the decal will be placed with a generous quantity of soapy water solution (a little dish soap in water, or a commercial cleaner like Sig Blue Magic Model Airplane Cleaner, "409", or "Fantastic" brand cleaners will all work equally well). Peel the paper backing sheet completely off the decal, being careful not to let the sticky side double over and adhere to itself. Place the decal onto the wet surface of the model. The soapy water will keep the decal from actually sticking to the model until you have had time to shift it around into exact alignment. Once you have it in exact position, use a small paddle of scrap sheet balsa to squeegee the excess soapy water out from under the decal. Squeegee repeatedly to get as much of the soapy water out from under the decal as possible. Allow to dry overnight. When completely dry, wash off the soap smears with a clean wet rag.

NOTE: These decals are completely fuel proof and cannot be harmed by any common model -airplane glow fuel containing less than 20% nitromethane. Higher quantities of nitromethane may cause slight deterioration of the decal over extended periods of time.

WARNING: Do not try to paint over these decals. Model cement, butyrate dope, lacquer, epoxy, and enamel paints may dissolve the decals. If you wish to top coat your decals, be sure to test for compatibility on a scrap decal before applying the paint. Frankly, Sig Mfg. Co. does not recommend top coating and will assume no liability for problems you may encounter.

23. Attaching The Tail Brace Wires

Four 2-56x10" threaded rods are provided for the Brace Wires. Cut two of them off at 8-3/4" long for the bottom brace wires. Leave the other two at 10" long for the top brace wires.

Four standard RC links (2-56 thread inside) and four solder links (unthreaded) are provided for the ends of the Tail Brace Wires. Take each link and cut off the side that has the pin in it. (A Dremel tool with an abrasive cut-off wheel works best.) Enlarge the hole in the remaining half with a #44 drill bit.

Screw one threaded link and jam nut onto the threaded end of each rod. Solder one of the unthreaded links to the other end of each.

Drill #44 holes through the stab and fin trailing edges at the brace wire attachment points drawn on the plans.

Fit the wires to the model. Bend the ends of the links as needed to make them fit flat against the model surface. Use 2-56x1/2" bolts and hex nuts to fasten the links through the stab and fin. Use #2x3/8" sheet metal screws to hold the bottom of the lower brace wires to the plywood tailwheel mount.

Adjust the threaded links and jam nuts until the wires are snug, but not pulling the tail surfaces out of shape.

Paint the tail brace wires after installation with epoxy paint.



24. Installing The Windshield And Side Windows

Cut the windshield from the 1-1/12"x17" clear plastic sheet, using the pattern on the plan. Cyanoacrylate adhesives (Hot Stuff, Jet, etc.) work best for gluing the windshield in place on the fuselage. This is a tedious and sometimes frustrating job - but a little patience and thought will usually be rewarded with a good fitting installation.

First pin the windshield in place as well as possible for a trial fit. Readjust where necessary. Then go around the edges and tack glue in several places. It's best to start gluing near the middle of the nose top and at the top of F5. Then work out towards the sides and the Windshield Braces. Don't try to bend the plastic around the Braces, just glue it to the front edge. When satisfied with the fit, glue all the edges permanently. When dry, trim off the excess plastic along the Windshield Braces.

Two 5-1/2"x17" pieces of clear plastic are provided for the side windows. One piece is to cover all the window area on one side of the airplane with no seams. Lay the plastic sheets on the fuselage and mark them about 1/8" larger than the outline of the windows. Cut out and glue on the outside surface of the model.



25. Preflight

Balance your model at the point indicated on the plan. If it balances further back, add weight to the nose as necessary. Trying to fly with the C.G. too far back is much more dangerous than the slight increase in wing loading caused by adding lead to the nose. Balance with an empty fuel tank.

Why Models Must Be Individually Balanced

It is impossible to produce a kit that will automatically have the correct balance point. Balsa wood varies in weight and it is easily possible for the wood in the tail of a model this large to be 2 or more ounces lighter or heavier than average. One ounce of extra weight in the tail has to be countered by about 3 ounces in the nose. Don't use a lot of finish or excess glue on the tail surfaces. The motor you choose, what form of muffler is fitted, the size and placement of your radio equipment, etc. all affect the balance. Don't feel that whatever C.G. the model builds out to as "good enough". Check carefully and make whatever adjustments that are required. With the C.G. properly located, the Cub should fly with only minor trim changes required.



Be certain to carefully range check your radio equipment and see how it operates with the engine running before attempting test flights. A lot of problems can be avoided if the engine has been well broken in and the idle adjustment perfected on a test block or in another airplane before installation in the new model.

A properly balanced and aligned model with a reliable engine and radio is assured of successful flights.

26. Flying

The Cub is not difficult to manage on the ground or in the air. However, being 1/4-scale and a taildragger, there are some differences you should be aware of between flying the Cub and flying most trainer or pattern type models. It handles more like a full size airplane than most smaller models.

When taxiing the Cub on the ground be prepared to use the elevators and ailerons in addition to the obvious rudder steering and throttle inputs. When the winds are calm, hold full up elevator while taxiing in any direction, to keep the tailwheel in firm contact with the ground for effective steering. Leave the ailerons in neutral, steer with the rudder, and control ground speed with the throttle. Under windy conditions, also hold up elevator when taxiing either upwind or crosswind. When going downwind, put the elevators in neutral or partly down to keep the wind from getting under the tail and flipping the Cub on its nose. Aileron deflection may also be needed while taxiing crosswind to keep the upwind wing from lifting off the ground.



Line the Cub up in the middle of the runway for takeoff. If you haven't had much taildragger time, it's best to stand directly behind the model so you can easily see any changes in heading that will need to be corrected during the takeoff run. Leave the elevator in neutral. Advance the throttle smoothly to full open. As the tail lifts up on its own, the Cub will try to drift to the left from torque. Feed in right rudder as needed to keep the model going straight. When you have flying speed, pull back slightly on elevator stick for a gentle liftoff. During the takeoff run, try not to overcontrol the rudder (the most common rookie tailwheel pilot's mistake) which will start the Cub swerving from one side of the runway to the other.

If you find yourself in that situation, pull the throttle back to full low and get the model stopped. Taxi it back for a fresh start. Never try to hurry the model off the ground by pulling full up elevator just because the model isn't going straight! The damage from a premature snap roll on takeoff would be much more severe than anything that could happen on the ground. Actually the Cub is one of the easiest taildraggers to takeoff that you'll find. Just keep practicing your takeoff run without lifting off until you learn to use the throttle, elevators, and rudder together.

In the air you'll find the Cub smooth, stable, and responsive. With practice it is capable of doing most basic aerobatic maneuvers such as inside loops, rolls, spins, and snaps. After you've had a chance to get the model all trimmed out, practice making your turns by coordinating rudder commands in with the ailerons, as is done in a full size airplane. Proper coordination of the rudder with the ailerons will make for a more graceful turn.

Landing the Cub directly into the wind or under calm conditions is pretty much like landing any other scale model. Be careful not to let the nose get too high during banks with the power off. Either wheel landings or three-point landings can be made with the Cub.



Just remember to fly the model even after it touches down (or you'll ground loop so fast it will make your head spin). Once the tailwheel gets back on the ground you'll have good steering and the model will slow down fast.

If there is any amount of crosswind, even quartering, landing the Cub (or any other taildragger) becomes a little trickier. Proper coordination of the ailerons and rudder is again needed to maintain your heading. After the model is turned onto final approach, use the rudder to hold the model on a straight heading with the runway and feed in aileron to correct any drifting to the side. For example, with a crosswind from the left, you'll need to hold a little right rudder to correct any "crab" angle (the model will be trying to weathervane into the crosswind) and put in left aileron to keep the model from drifting to the right.

If all these hints make it sound as if the Cub is difficult to fly, it really isn't! In many ways flying quarter-scale is easier than flying a faster, smaller model. The Cub can be safely flown by anyone who is capable of handling a multi-channel model. Once you get a few flights under your belt, you'll find rudder/aileron coordinated flying becoming second nature - and you'll be a better pilot with all types of models.

GOOD LUCK!



FULL WINDSHIELD

FOR
SIG 1/4-Scale CLIPPED WINDSHIELD
SIG 1/4-Scale PIPER J-3C



-SIZE D PATTERN

R

IG CUB, Kit No. SIGRC47

CUB, Kit No. SIGRC48



**Print and cut out the three
windshield pattern pieces.
Join the three pieces
together for the full pattern.**



If you have any technical questions or comments about this kit, or any other SIG product, please call us.

SIG MODELER'S HOTLINE

1-800-524-7805

Weekdays, 7:00am - 4.30pm Central

© Copyright SIG Mfg. Co., Inc.

SIG MFG. CO., INC.....Montezuma, Iowa 50171-0520

LIMIT OF LIABILITY:

In use of our products, Sig Mfg. Co.'s only obligation shall be to replace such quantity of the product proven to be defective. User shall determine the suitability of the product for his or her intended use and shall assume all risk and liability in connection therewith.