

Operation



MODEL MVP-6CFM VAPOR RECOVERY PUMP

3A5262B EN

Designed for hydrocarbon extraction processing.

For LP-Gas Recovery

Electric-Powered

Dual-Diaphragm

Explosion-Proof Motor

Stainless Steel Wetted Parts

Rated MAWP: LPG-350-PSI

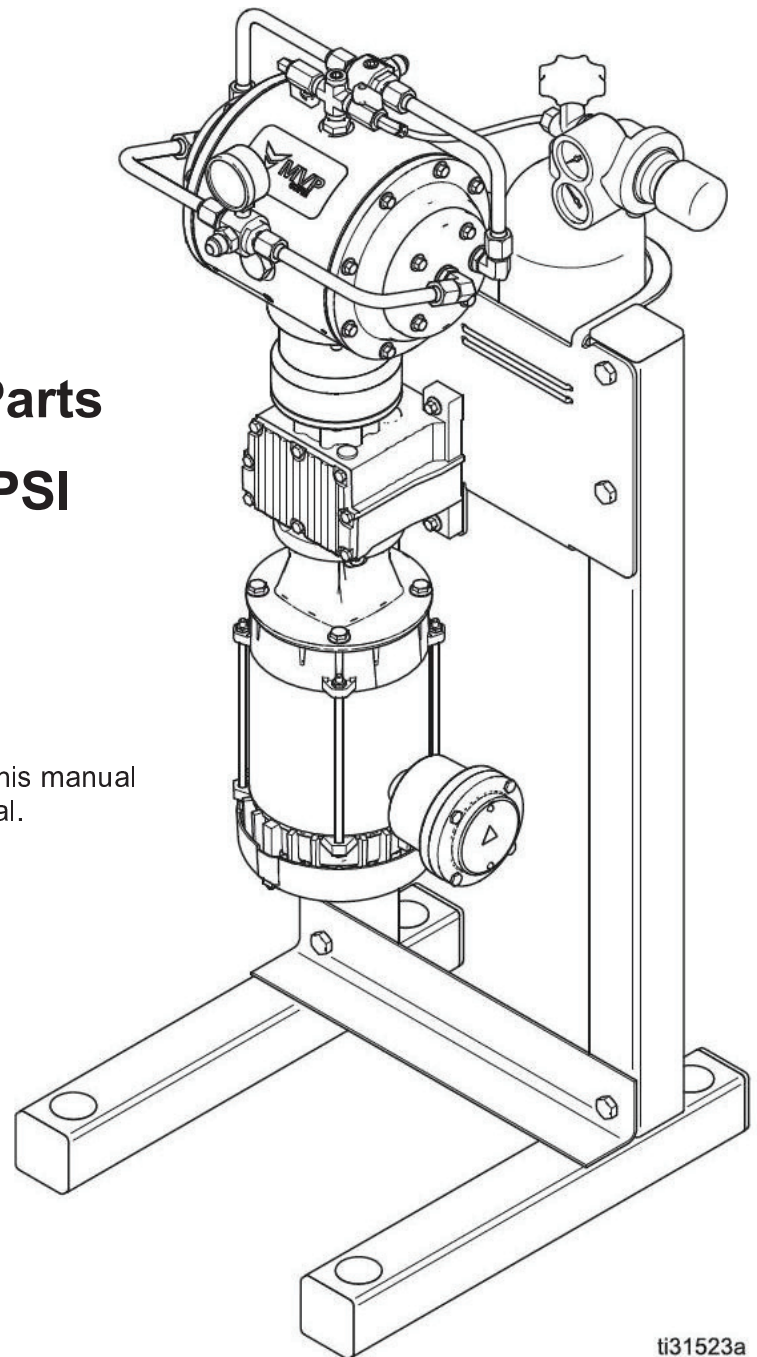

For professional use only.



Important Safety Instructions

Read all warning and instruction in this manual
and in the pump Repair/Parts manual.

Save these instructions.

Contents

Related Manuals	2	Operation	9
Models	2	Tighten Fasteners	9
Approvals	2	Pump Head CO2 Charging	9
Warnings	3	Running the Pump	9
General Information	6	Pressure Relief Procedure	9
Installation	7	Pump Shutdown	9
Tighten Fasteners	7	Maintenance	10
Moving/Mounting the Pump	7	Maintenance Schedule	10
Grounding	7	Tighten Threaded Connections	10
CO2 Cylinder	7	Flushing and Storage	10
Pump Inlet	7	Torque Instructions	10
Pump Outlet	7	Dimensions	12
Pressure Gauges	8	Technical Data	13
Electrical Connections	8	MVP Standard Warranty	14

Related Manuals



Manual Number	Title
3A5263	Model MVP-6CFM Vapor Recovery Pump, Repair/Parts

Models

See ID tag for model number.





Model	Includes:		
	Motor	Pump	CO ₂ Cylinder
MVP-6CFM-1PH	1 HP 1 Phase	yes	no
MVP-6CFM-3PH	1 HP 3 Phase	yes	no









Approvals



Motor Approvals	
	Explosion-proof for Class I, Division 1 (C1D1) hazardous areas
	Class I Group C&D, Class II Group F&G, T3C

Warnings

The following warnings are for the setup, use, grounding, maintenance, and repair of this equipment. The exclamation point symbol alerts you to a general warning and the hazard symbols refer to procedure-specific risks. When these symbols appear in the body of this manual or on warning labels, refer back to these Warnings. Product-specific hazard symbols and warnings not covered in this section may appear throughout the body of this manual where applicable.

 <h1 style="margin: 0;">WARNING</h1>	
	<p>ELECTRIC SHOCK HAZARD</p> <p>This equipment must be grounded. Improper grounding, setup, or usage of the system can cause electric shock.</p> <ul style="list-style-type: none"> • Turn off and disconnect power at main switch before disconnecting any cables and before servicing or installing equipment. • Connect only to grounded power source. • All electrical wiring must be done by a qualified electrician and comply with all local codes and regulations.
	<p>FIRE AND EXPLOSION HAZARD</p> <p>Flammable fumes in work area can ignite or explode. Vapor or solvent flowing through the equipment can cause static sparking. To help prevent fire and explosion:</p> <ul style="list-style-type: none"> • Use equipment only in well ventilated area. • Eliminate all ignition sources; such as pilot lights, cigarettes, portable electric lamps, and plastic drop cloths (potential static arc). • Ground all equipment in the work area. See Grounding instructions. • Keep work area free of debris, including solvent, rags and gasoline. • Do not plug or unplug power cords, or turn power or light switches on or off when flammable fumes are present. • Stop operation immediately if static sparking occurs or you feel a shock. Do not use equipment until you identify and correct the problem. • Keep a working fire extinguisher in the work area.
	<p>PRESSURIZED EQUIPMENT HAZARD</p> <p>Vapor or solvent from the equipment, leaks, or ruptured components can splash in the eyes or on skin and cause serious injury.</p> <ul style="list-style-type: none"> • Follow the Pressure Relief Procedure when you stop operation and before cleaning, checking, or servicing equipment. • Tighten all hose and pressure connections before operating the equipment. • Check hoses, tubes, and couplings daily. Replace worn or damaged parts immediately.

 <h1 style="margin: 0;">WARNING</h1>	
 	<p>EQUIPMENT MISUSE HAZARD</p> <p>Misuse can cause death or serious injury.</p> <ul style="list-style-type: none"> • Do not operate the unit when fatigued or under the influence of drugs or alcohol. • Do not exceed the maximum working pressure or temperature rating of the lowest rated system component. See Technical Data in all equipment manuals. • Use solvents that are compatible with equipment wetted parts. See Technical Data in all equipment manuals. Read solvent manufacturer's warnings. For complete information about your material, request Safety Data Sheet (SDS) from distributor or retailer. • Turn off all equipment and follow the Pressure Relief Procedure when equipment is not in use. • Check equipment daily. Repair or replace worn or damaged parts immediately with genuine manufacturer's replacement parts only. • Do not alter or modify equipment. Alterations or modifications may void agency approvals and create safety hazards. • Make sure all equipment is rated and approved for the environment in which you are using it. • Use equipment only for its intended purpose. Call your distributor for information. • Route hoses and cables away from traffic areas, sharp edges, moving parts, and hot surfaces. • Do not kink or over bend hoses or use hoses to pull equipment. • Keep children and animals away from work area. • Comply with all applicable safety regulations.
  	<p>THERMAL EXPANSION HAZARD</p> <p>Liquids subjected to heat in confined spaces, especially in hoses and pipes, can create a rapid rise in pressure due to the thermal expansion. Over-pressurization can result in equipment rupture and serious injury.</p> <ul style="list-style-type: none"> • All hoses and pipes possibly exposed to liquid LP-Gas must be fitted with proper hydrostatic relief valves to prevent over-pressurization. • Replace hoses proactively at regular intervals based on your operating conditions.
 	<p>LP-GAS HAZARD</p> <p>LP-Gas can cause serious injury or death if splashed in the eyes or on skin, inhaled, or ignited.</p> <ul style="list-style-type: none"> • Read Safety Data Sheet (SDS) to know the specific hazards of the solvents you are using. • Store hazardous solvent in approved containers, and dispose of it according to applicable guidelines.

 WARNING	
	<p>BURN HAZARD</p> <p>Equipment surfaces can become very hot during operation. To avoid severe burns:</p> <ul style="list-style-type: none">• Do not touch hot equipment.
	<p>PERSONAL PROTECTIVE EQUIPMENT</p> <p>Wear appropriate protective equipment when in the work area to help prevent serious injury, including eye injury, hearing loss, inhalation of fumes, and burns. This protective equipment includes but is not limited to:</p> <ul style="list-style-type: none">• Protective eyewear, and hearing protection.• Respirators, protective clothing, and gloves as recommended by the solvent manufacturer.

General Information

Install all products in accordance with manufacturer's recommendations, and local codes and regulations.

NOTE: For outdoor applications, be sure to provide adequate protection from the elements.

The Typical Installation shown below is only a guide for selecting and installing system components. Contact your MVP distributor for assistance in planning a system to suit your needs. Always use Genuine MVP Parts and Accessories. Be sure all accessories are adequately sized and pressure rated to meet the system's requirements.

Reference letters in the text, for example (A), refer to the callouts in the figures.

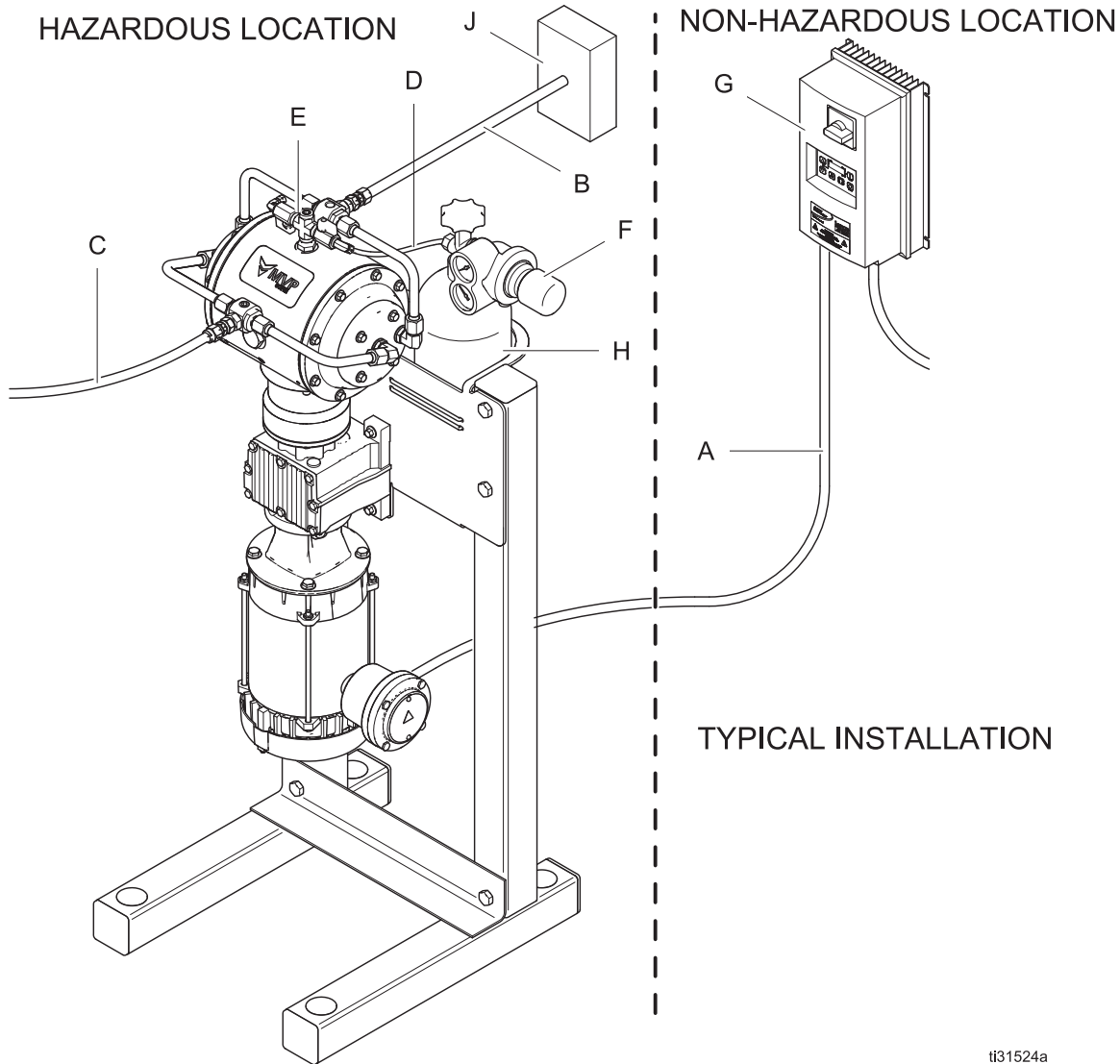

System Components

- A C1D1 electrical connection
- B Pump inlet
- C Pump outlet
- D CO₂ supply line from regulator
- E Pump head CO₂ port and valves
- F CO₂ regulator assembly

Accessories/Components Not Supplied

- G VFD or ON/OFF switch *
- H CO₂ supply tank
- J Liquid prevention auxiliary device

* A C1D1-rated ON/OFF switch can be located within the hazardous location.

ti31524a

Installation

Tighten Fasteners

Before using the pump, check and retorque all external fasteners. Follow [Torque Instructions, page 10](#). After the first day of operation, retorque the fasteners.

Moving/Mounting the Pump

NOTICE
<p>The pump is heavy. To prevent damage from dropping, always use 2 people or a lift to move the pump. Do not use the manifolds to lift the pump. Use at least one strap attached to the center section.</p>

1. For all mountings, be sure the pump is secured with four screws through the mounting stand feet. See [Dimensions, page 12](#) for size and location of mounting stand holes.
2. Make sure the surface is flat and that the pump doesn't wobble.
3. For ease of operation and service, mount the pump so pump inlet and pump outlet ports are easily accessible.

Grounding

<p>The equipment must be grounded to reduce the risk of static sparking and electric shock. Electric or static sparking can cause fumes to ignite or explode. Improper grounding can cause electric shock. Grounding provides an escape wire for the electric current.</p> <ul style="list-style-type: none"> • Always ground the entire pump system as described below. • Follow your local fire codes. 				

Before operating the pump, ground the system as explained below.

- **System equipment:** All tanks and accessories of the complete extraction system must be grounded to true earth ground.
- **VFD or ON/OFF switch:** Ground through a proper connection to the electrical system. Refer to the manufacturer's instructions for grounding instructions.

- **Motor:** Motors have a ground screw in the electrical box. Use it to ground the motor to the electrical system.
- **Pump:** Loosen the grounding screw (R). Insert one end of a 12-gauge minimum ground wire behind the ground screw and tighten the screw securely. Connect the clamp end of the grounding wire to a true earth ground.

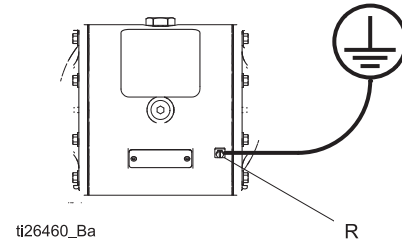

Check your system electrical continuity after the initial installation, and then set up a regular schedule for checking continuity to be sure proper grounding is maintained. The resistance should not exceed 1 megohm.

CO₂ Cylinder

Pump is supplied with CO₂ regulator and hose. Install as shown in [General Information, page 6](#). The CO₂ cylinder must be provided by customer. This is a standard (#20) 5 lb. tank of industrial CO₂ available from welding supply stores. A tank should last for hundreds of pump operating hours.

Pump Inlet

<p>This pump is not intended to pump liquid. Liquid inside the pump, if heated, can create a rapid rise in pressure due to thermal expansion, which can result in equipment rupture and serious injury.</p>				

- Connect an LP-Gas rated hose from the extractor to the pump inlet port. The port is 1/2 in. JIC-male.
- MVP recommends installation of an auxiliary device before the pump inlet, if necessary, to prevent entrance of liquid into the pump.





Pump Outlet

Connect an LP-Gas rated hose from the pump outlet port to the extractor. The port is 1/2 in. JIC-male.

Pressure Gauges

A pressure gauge may be added at the inlet tee and outlet tee fittings. Use gauges with stainless steel wetted parts and 1/4 in. npt(m) threads.

Electrical Connections

				
<p>To avoid injury from fire, explosion, or electric shock, all electrical wiring must be done by a qualified electrician and comply with all local codes and regulations for C1D1 electrical connection.</p>				

Wire Connections at the Explosion-proof Motor

Install the wiring at the motor as follows:

1. Open the motor's electrical box.
2. Install wiring system with proper connections to the motor electrical box. A C1D1 installation requires conduit or armored cable with sealing fittings in accordance with NFPA 70.
3. Connect the green ground wire to the ground screw.
4. **For 460V, 3 Phase, Wiring (model MVP-6CFM-3PH):** Connect wire L1 to T1, L2 to T2, and L3 to T3, and bridge the other wires, as shown.

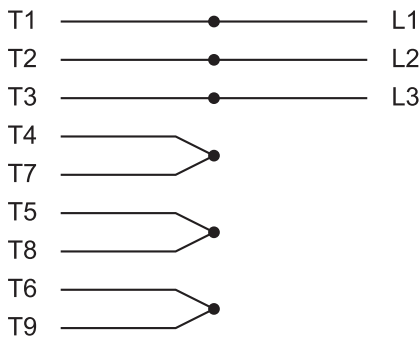

5. **For 230V, 3 Phase, Wiring (model MVP-6CFM-3PH):** Bridge the wires as shown. Then, connect L1 to T1/T7, L2 to T2/T8, and L3 to T3/T9.

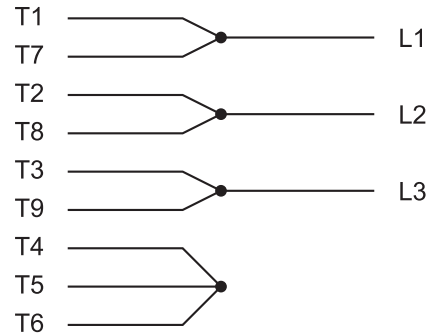

6. **For 230V, Single Phase, Wiring (model MVP-6CFM-1PH):** Bridge the wires as shown. Then, connect L1 to P1 and L2 to T4/T5.

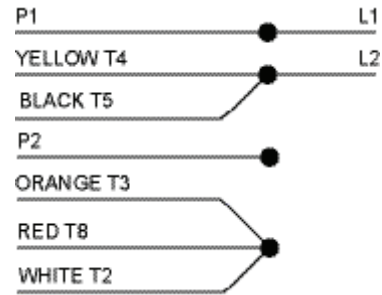

7. **For 115V, Single Phase, Wiring (model MVP-6CFM-1PH):** Bridge the wires as shown. Then, connect L1 to P1 and L2 to T2/T4/T5.

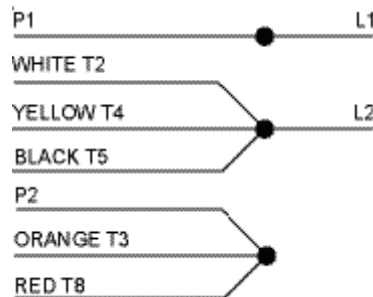

8. **Option:** Connect thermostat wires P1 and P2 to external overload detection. Thermostat is NC (normally closed).
9. Close the motor electrical box. Torque the screws to 20 in-lb (2.3 N•m).

Operation

Tighten Fasteners

Before using the pump, check and retorque all external fasteners. Follow [Torque Instructions, page 10](#). After the first day of operation, retorque the fasteners.

Pump Head CO₂ Charging

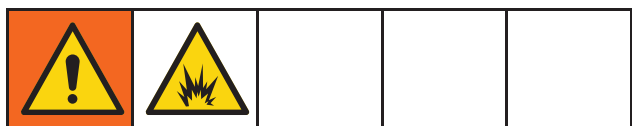

In the event of a diaphragm rupture, vapor will enter the pump head center section. To avoid fire and explosion, always replace air in the center section with CO₂.

Prior to using the pump, it is necessary to replace all air in the center section with CO₂. The pump head center section drives the pumping with the CO₂ gas charge. To ensure no air is present, use the following method.

1. At the CO₂ port (E), close the center section vent valve.
2. At the CO₂ port (E), open the CO₂ supply line valve and adjust the CO₂ regulator to set the CO₂ to the maximum pressure setting of 70 psi.
3. Close the CO₂ supply line valve and open the center section vent valve.
4. Repeat steps 1–3 a second time to purge any remaining air.
5. Repeat steps 1 & 2 to place the pump in operational state.

The maximum pumping pressure will be a few psi less than the internal CO₂ pressure setting.

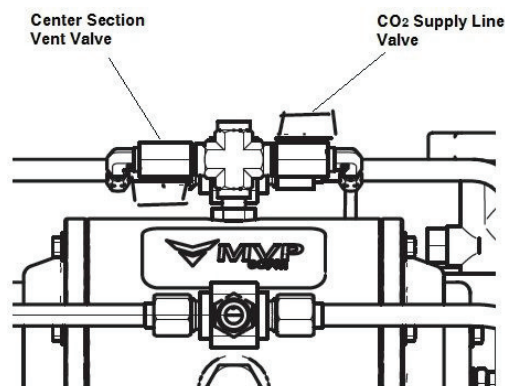

Running the Pump

1. Be sure the system is properly grounded. See [Grounding, page 7](#).
2. Check fittings to be sure they are tight. Tighten inlet and outlet fittings securely.
3. Run the pump; starting, stopping, and operating process valves according to the extractor system instructions.

Pressure Relief Procedure



Follow the Pressure Relief Procedure whenever you see this symbol.

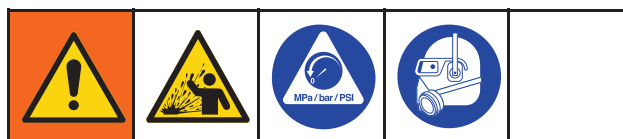

This equipment stays pressurized until pressure is relieved manually. To help prevent serious injury from pressurized vapor, follow the Pressure Relief Procedure when you stop pumping for an extended period of time, and before you clean, check, or service the equipment.

1. Remove electric power from the system.
2. Vent all LP-Gas vapor from the pump and hoses according to extractor system instructions.
3. Close the shutoff valve on the CO₂ cylinder.
4. On CO₂ port (E), open the pump CO₂ bleed valve and CO₂ supply valve.

NOTE: In the event of a diaphragm rupture, LP-Gas may be present in the pump center section. Always vent all LP-Gas according to extractor system instructions.

Pump Shutdown

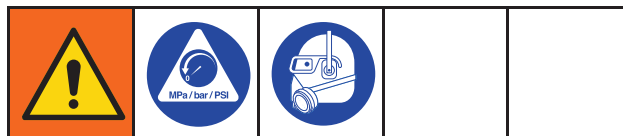

Before you check, adjust, clean, or repair the system, follow the [Pressure Relief Procedure, page 9](#).

Maintenance

Maintenance Schedule

Establish a preventive maintenance schedule based on the pump's service history. Scheduled maintenance is especially important to prevent spills or leakage due to diaphragm failure.

Tighten Threaded Connections

Before each use, check all hoses for wear or damage and replace as necessary. Check to be sure all threaded connections are tight and leak-free. Check mounting bolts. Check fasteners. Tighten or retorque as necessary. Although pump use varies, a general guideline is to retorque fasteners every two months. See [Torque Instructions](#), page 10.

NOTE: Cover and cap screws have a thread-locking adhesive patch applied to the threads. If this patch is excessively worn, the screws may loosen during operation. Replace screws with new ones or apply medium-strength (blue) thread locker to the threads.

NOTE: Always completely torque covers and caps before tightening manifolds.

1. Start all screws a few turns. Then, turn down each screw just until head contacts cover.
2. Turn each screw by 1/2 turn or less working in a crisscross pattern in the order shown to specified torque.

Diaphragm covers and vapor cap screws: 90 in-lb (10.2 Nm)

Flushing and Storage

				
<p>To avoid fire and explosion, always ground equipment and waste container. To avoid static sparking and injury from splashing, always flush at the lowest possible pressure.</p>				

- Flush before first use.
- Flush at the lowest pressure possible. Check connectors for leaks and tighten as necessary.
- Flush with a fluid that is compatible with the LP-Gas being dispensed and the equipment wetted parts.
- Always flush the pump and relieve the pressure before long term storage.

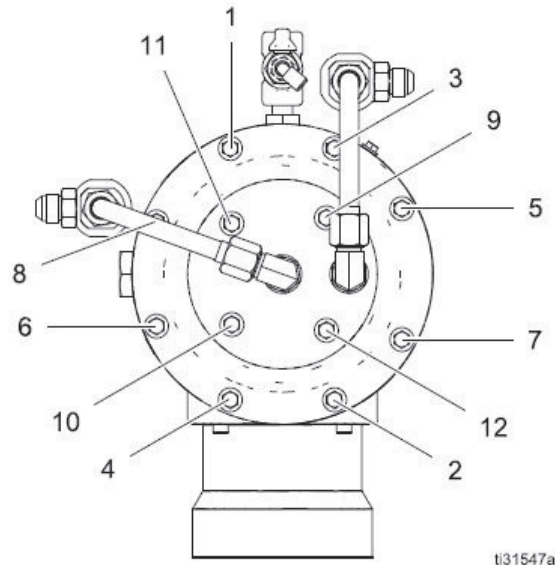

Torque Instructions

If diaphragm cover or vapor cap fasteners have been loosened, it is important to torque them using the following procedure to improve sealing.

Dimensions

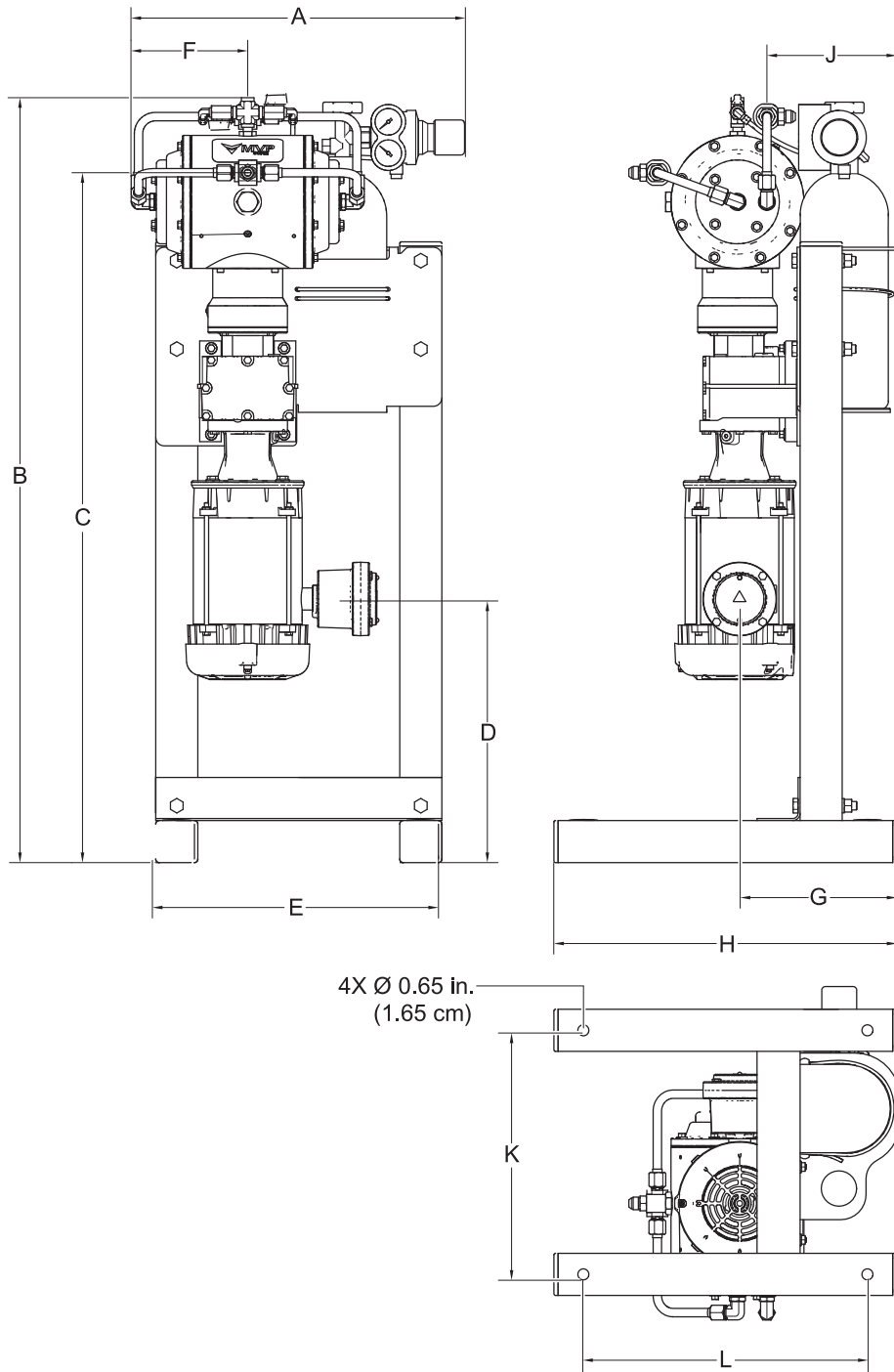

Ref.	Inches	CM
A	20.0	50.8
B	46.0	116.8
C	41.0	104.0
D	15.0	38.1
E	17.0	43.2
F	7.0	17.8
G	6.8	17.3
H	19.9	50.5
J	7.7	19.6
K	14.5	36.8
L	16.9	42.9

1131541a

Technical Data

	US	Metric
Model MVP-6CFM Vapor Recovery Pump		
LP-Gas vapor recovery rate	6 cfm	0.17 m ³ /min
Butane recovery rate	1 lb/min	0.45 kg/min
Butane recovery and re-condense rate	12 GPH	45.42 L/hour
Maximum pumping outlet pressure, continuous	60 psi	0.41 MPa, 4.1 bar
Maximum pumping outlet pressure, intermittent	70 psi	0.48 MPa, 4.8 bar
Maximum pumping inlet vacuum produced	27 inHg	91 kPa, 0.91 bar
Center section CO ₂ charge range, continuous	5 to 70 psi	0.03–0.48 MPa, 0.3–4.8 bar
Center section CO ₂ charge range, intermittent	80 psi	0.55 MPa, 5.5 bar
Equipment Withstand Pressure	350 psi	2.41 MPa, 24.1 bar
Maximum CO ₂ consumption	<0.2 scfh	<0.006 cubic meters/hour
CO ₂ inlet size	1/4 in. npt(f)	
Maximum pump speed	190 cpm	
Process Inlet and Outlet Size	1/2 in. JIC male	
Optional pressure gauge ports: inlet and outlet	1/4 in. npt(f)	
Weight	182.5 lb	82.8 kg
Electric Motor: Explosionproof for C1D1 hazardous areas (see approvals page)		
Model MVP-6CFM-3PH, inverter rated		
Power	1 Hp	0.75 kW
Speed	1800 rpm (60 Hz)	
Gear Ratio	9.41	
Voltage	3-phase 208-230/460V	
Maximum Amperage Load	3.3 A (230V) / 1.65 A (460V)	
Model MVP-6CFM-1PH		
Power	1 Hp	0.75 kW
Speed	1800 rpm (60 Hz)	
Gear Ratio	9.41	
Voltage	1-phase 115/208-230V	
Maximum Amperage Load	13.4 A (115V) / 6.7 A (230V)	
Noise Data		
Sound Power (measured per ISO-9614–2)	88.5 dBa	
Sound Pressure [tested 3.28 ft (1 m) from equipment]	80.5 dBa	
Materials		
Process Pressure Section and Reed Valves	stainless steel	
Diaphragms	standard: PTFE optional: FKM fluoroelastomer	
Process Vapor Temperature Range	FKM: -40° to 275°F (-40° to 135°C) PTFE: +40° to 220°F (+4° to 104°C)	

MVP Standard Warranty

MVP warrants all equipment referenced in this document which is manufactured by MVP and bearing its name to be free from defects in material and workmanship on the date of sale to the original purchaser for use. With the exception of any special, extended, or limited warranty published by MVP, MVP will, for a period of twelve months from the date of sale, repair or replace any part of the equipment determined by MVP to be defective. This warranty applies only when the equipment is installed, operated and maintained in accordance with MVP's written recommendations.

This warranty does not cover, and MVP shall not be liable for general wear and tear, or any malfunction, damage or wear caused by faulty installation, misapplication, abrasion, corrosion, inadequate or improper maintenance, negligence, accident, tampering, or substitution of non-MVP component parts. Nor shall MVP be liable for malfunction, damage or wear caused by the incompatibility of MVP equipment with structures, accessories, equipment or materials not supplied by MVP, or the improper design, manufacture, installation, operation or maintenance of structures, accessories, equipment or materials not supplied by MVP.

This warranty is conditioned upon the prepaid return of the equipment claimed to be defective to an authorized MVP distributor for verification of the claimed defect. If the claimed defect is verified, MVP will repair or replace free of charge any defective parts. The equipment will be returned to the original purchaser transportation prepaid. If inspection of the equipment does not disclose any defect in material or workmanship, repairs will be made at a reasonable charge, which charges may include the costs of parts, labor, and transportation.

THIS WARRANTY IS EXCLUSIVE, AND IS IN LIEU OF ANY OTHER WARRANTIES, EXPRESS OR IMPLIED, INCLUDING BUT NOT LIMITED TO WARRANTY OF MERCHANTABILITY OR WARRANTY OF FITNESS FOR A PARTICULAR PURPOSE.

MVP's sole obligation and buyer's sole remedy for any breach of warranty shall be as set forth above. The buyer agrees that no other remedy (including, but not limited to, incidental or consequential damages for lost profits, lost sales, injury to person or property, or any other incidental or consequential loss) shall be available. Any action for breach of warranty must be brought within two (2) years of the date of sale.

MVP MAKES NO WARRANTY, AND DISCLAIMS ALL IMPLIED WARRANTIES OF MERCHANTABILITY AND FITNESS FOR A PARTICULAR PURPOSE, IN CONNECTION WITH ACCESSORIES, EQUIPMENT, MATERIALS OR COMPONENTS SOLD BUT NOT MANUFACTURED BY MVP. These items sold, but not manufactured by MVP (such as electric motors, switches, hose, etc.), are subject to the warranty, if any, of their manufacturer. MVP will provide purchaser with reasonable assistance in making any claim for breach of these warranties.

In no event will MVP be liable for indirect, incidental, special or consequential damages resulting from MVP supplying equipment hereunder, or the furnishing, performance, or use of any products or other goods sold hereto, whether due to a breach of contract, breach of warranty, the negligence of MVP, or otherwise.

FOR MVP CANADA CUSTOMERS

The Parties acknowledge that they have required that the present document, as well as all documents, notices and legal proceedings entered into, given or instituted pursuant hereto or relating directly or indirectly hereto, be drawn up in English. Les parties reconnaissent avoir convenu que la rédaction du présente document sera en Anglais, ainsi que tous documents, avis et procédures judiciaires exécutés, donnés ou intentés, à la suite de ou en rapport, directement ou indirectement, avec les procédures concernées.

MVP Information

For the latest information about MVP products, visit MasterVaporPumps.com.

Protected as patented technology.

To place an order, contact your MVP Distributor or call to identify the nearest distributor.

Toll Free: 1-888-502-3303

Email: info@MasterVaporPumps.com

All written and visual data contained in this document reflects the latest product information available at the time of publication.

MVP reserves the right to make changes at any time without notice.

Original Instructions. This manual contains English. MM 3A5262

MVP Headquarters: Santa Cruz

**Master Vapor Pumps LLC • 849 Almar Ave., Suite C, #209 • Santa Cruz CA 95060 • USA
Copyright 2017, Master Vapor Pumps LLC.**

MasterVaporPumps.com
Revision B, September 2017