

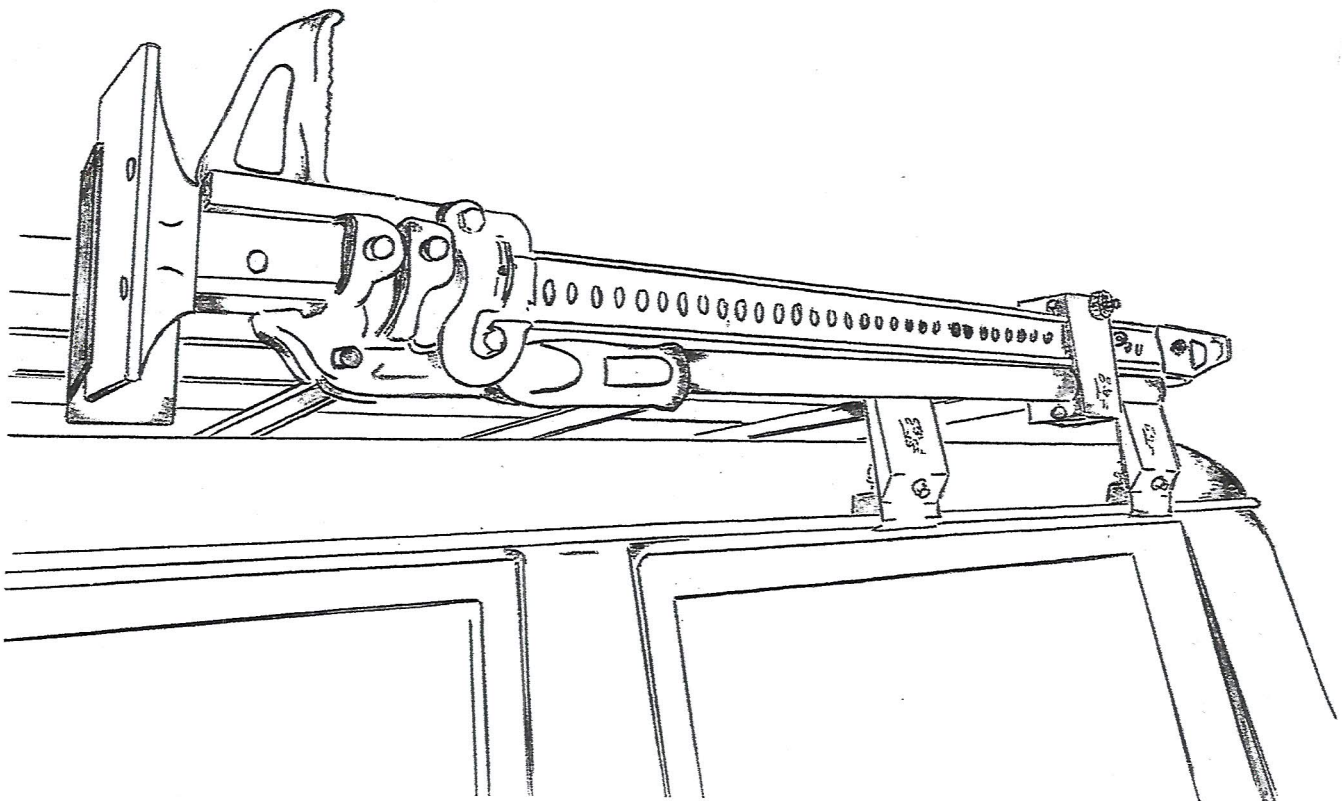

P.O. Box 68323, Bryanston 2021
200 Cussonia Park, 3 Ridge Road,
Laser Park, Honeydew, South Africa.
Tel: (011) 794-6311 • Fax: (011) 794-6233



K9 JACK BRACKET MOUNTING INSTRUCTIONS



INSTALLATION WARNING:

1. It is important that all K9 Racks and accessories are correctly attached (fastened) and secured to your vehicle.
2. Negligent installation of the K9 Rack and accessories could lead to an unfortunate vehicle accident. Furthermore injury and cause bodily harm or even lead to the demise of other folk.
3. Remember you are personally responsible in securing and checking the installation of your K9 Rack on your vehicle.
4. Once fitted the K9 Rack installation should be checked on a regular basis and if need be adjusted or secured.
5. Before you commence installation of your K9 Rack it is imperative that you read the instructions thoroughly to understand and be prepared for the assembly.
6. Should you not fully understand the assembly and installation instructions of the K9 Rack and you are apprehensive that you do not have the technical or mechanical know-how it would be in your interest to have the K9 Rack installed by a qualified professional at a garage or fitment centre.
7. Lastly it is extremely important that your equipment including the weight of the K9 Rack does not exceed your vehicles maximum roof load specifications.
8. In order to obtain your vehicle specifications one would need to contact your vehicle manufacturer or distributor or look in your service book provided with your vehicle.



Eezi-Awn



GETTING STARTED:

10mm Spanner Wrench
 13mm Socket Wrench
 17mm Spanner Wrench
 5mm Allan key
 Padlock (not supplied)
 Jack bag (optional extra)

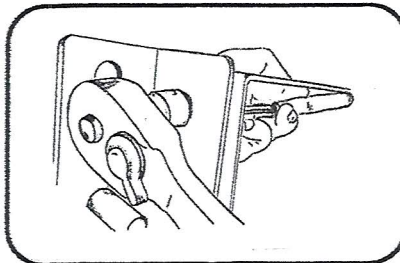

Secure L bracket to face plate with counter sunk bolts provided.

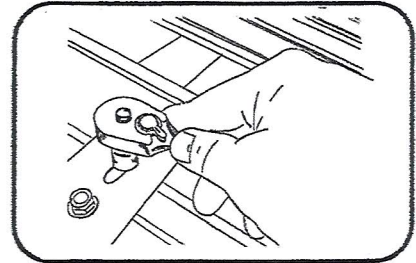

Place L bracket onto K9 rack in required position.

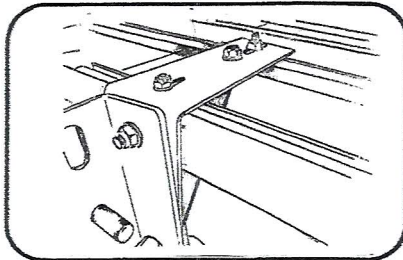

Mount gusset to top of L bracket.

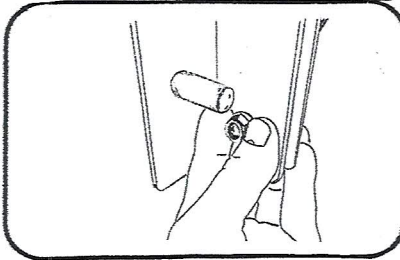

Mount gusset to face plate.

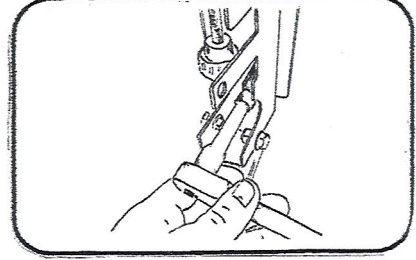

Repeat diagrams 1,2,3 with jack locking mechanism.

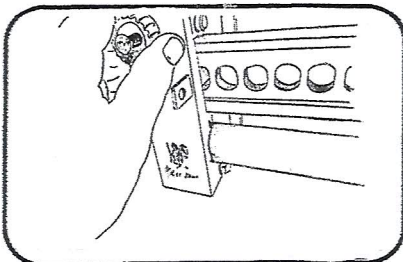

Place jack into bracket close cover and tighten with thumb lock.

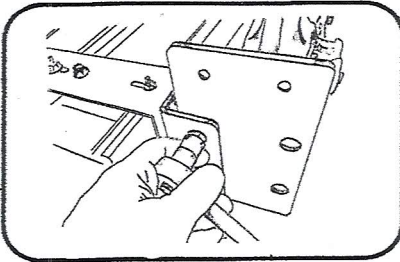

Secure jack base plate to jack face plate with bolts provided tighten with 17mm spanner wrench .

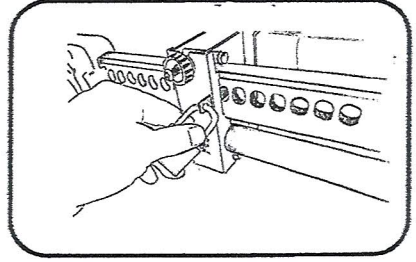

Should you require the jack bracket to be locked insert padlock (not supplied) into tab provided.

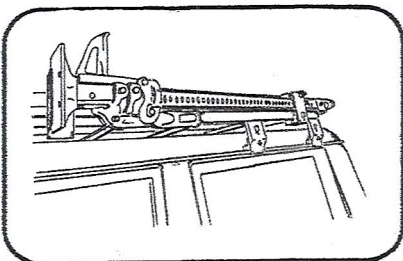

JOB WELL DONE!

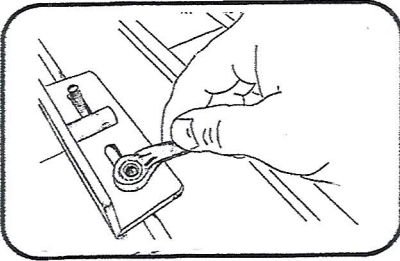

Should you wish to mount jack bracket onto slats slide 8mm bolts into grooves and tighten with 13mm spanner wrench into required position.

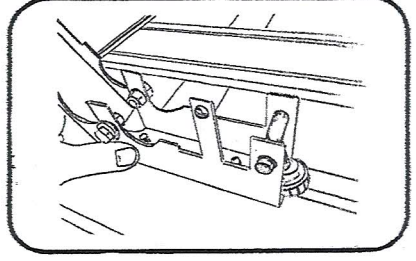

Place jack locking mechanism in required position and hand tighten.



Eezi-Awn

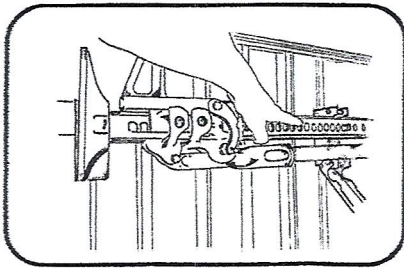

Use the jack in order to align mechanism with jack face plate.

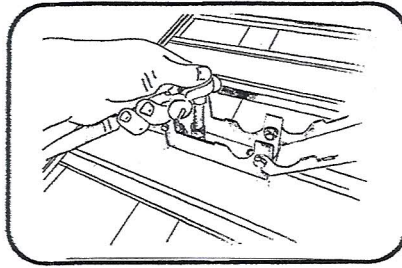

Remove jack and tighten with 13mm socket wrench.

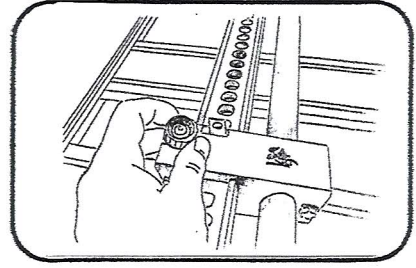

Place jack into bracket close cover and tighten with thumb lock.

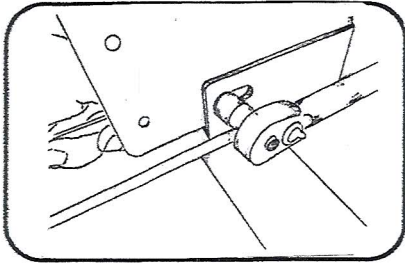

Secure jack base plate to face plate with bolts provided tighten with 17mm spanner wrench.

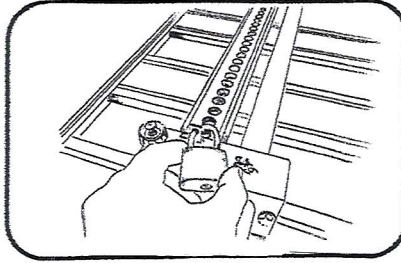

Should you require the jack bracket to be locked insert padlock (not supplied) into tab provided.

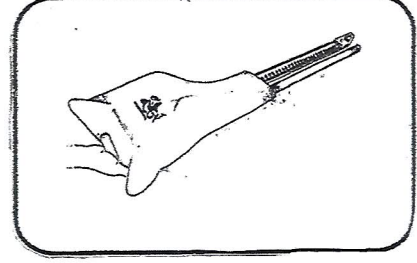

Slide k9 jack bag over jack and secure with Velcro (bag is a optional extra)

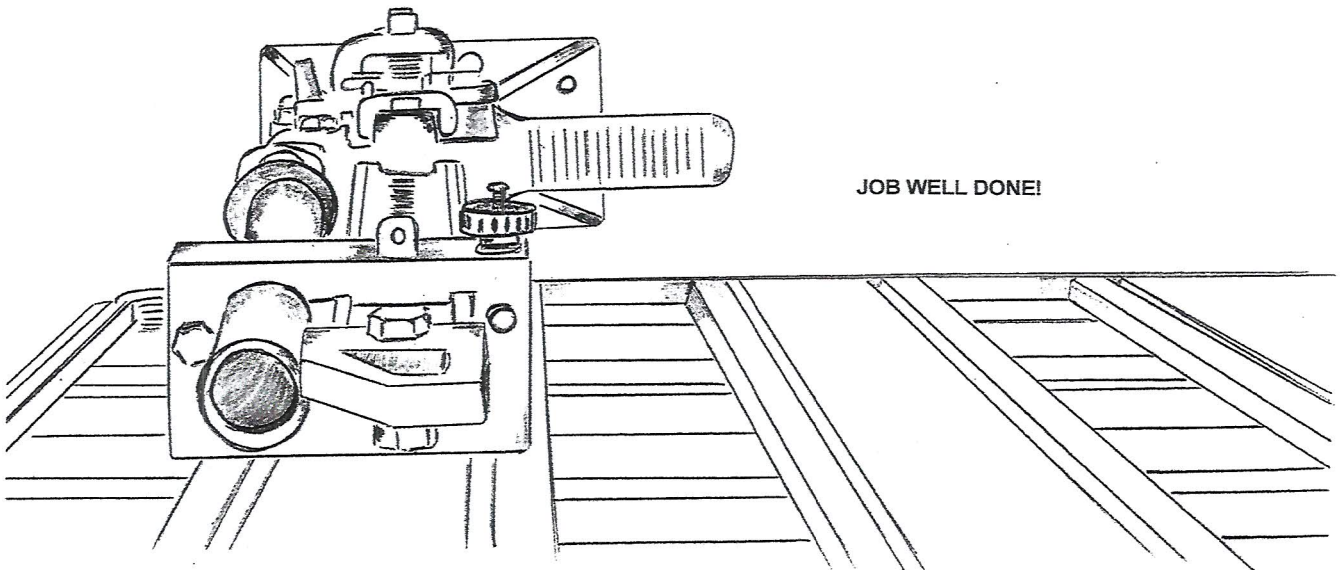

JOB WELL DONE!