



www.eezilawn.com

ROOFTENT

OPERATING INSTRUCTIONS

PO.BOX 68323 Bryanton 2021
200 Cussonia Park, 3Ridge Road
Laser Park, Honeydew, South Africa
Tel : (011)794-6311 Fax (011)794-6233

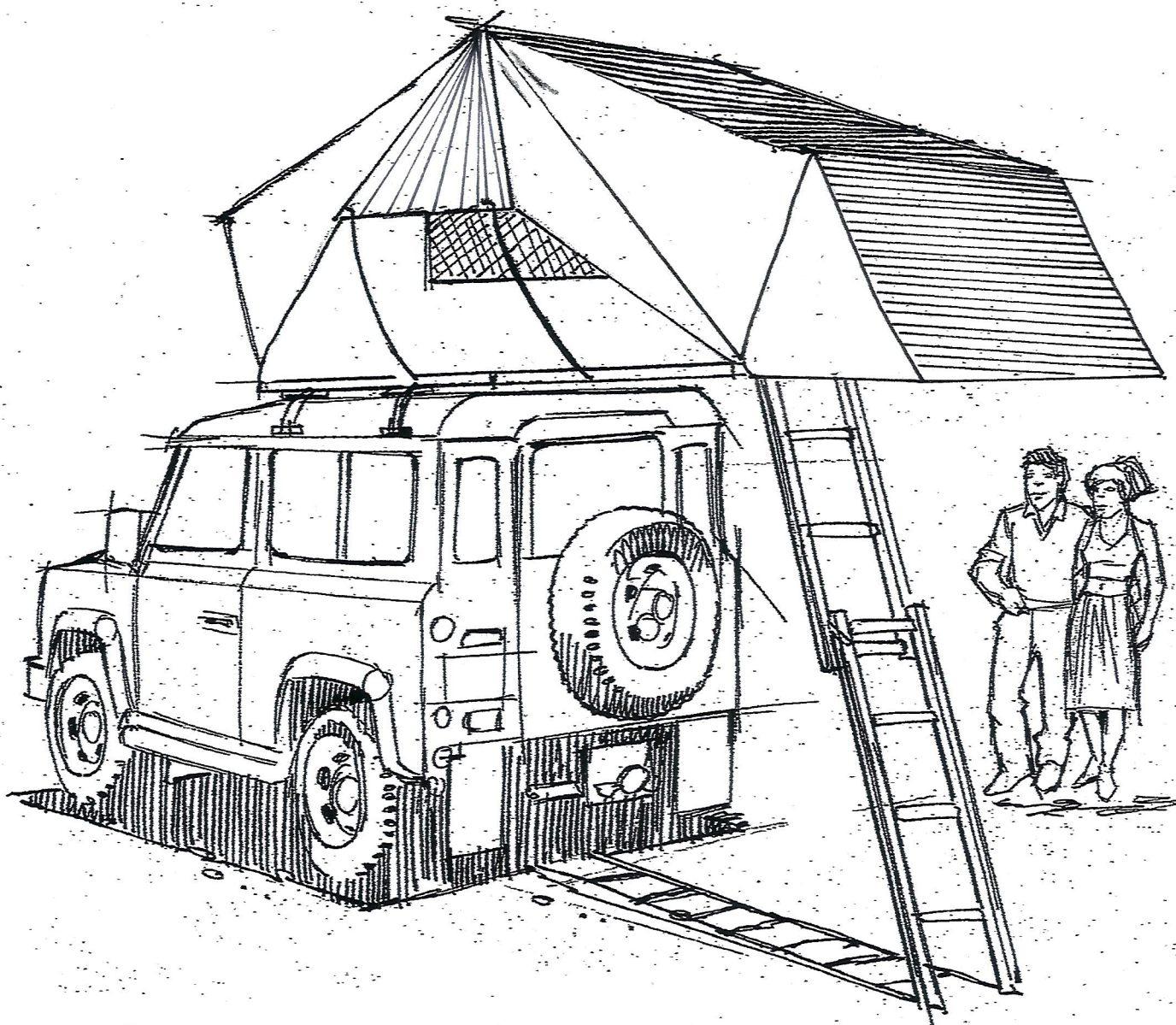

HELPFUL HINTS

1. Always make sure TENT is dry when stored - away from RATS and MICE.
2. Do not wash TENT with detergent. ONLY wipe with CLEAN CLOTH.



ROOFTENT

OPERATING INSTRUCTIONS TO OPEN

PO.BOX 68323 Bryanston 2021
200 Cussonia Park, Ridge Road
Laser Park, Honeydew, South Africa
Tel : (011)794-6311 Fax: (011)7946233

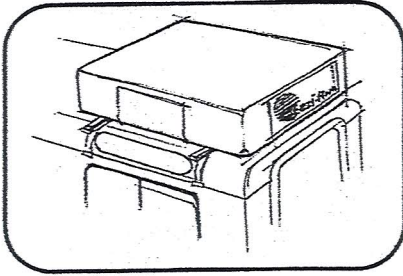

Enclosed rooftop tent with travel cover.

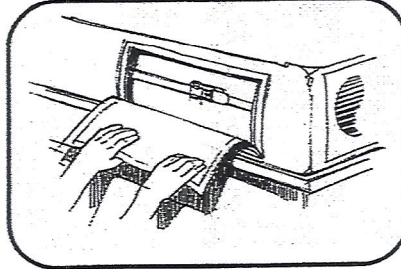

Open flap to access ratchet in order to remove travel cover.

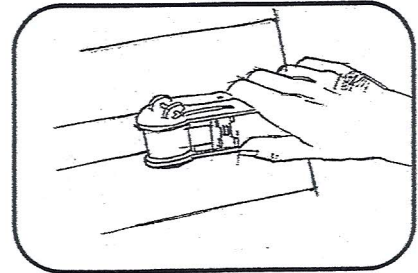

Pull ratchet-head forward to release strap and remove travel cover.

NOTE: Should ladder be separately delivered of rooftop tent, then fit ladder as follows:--

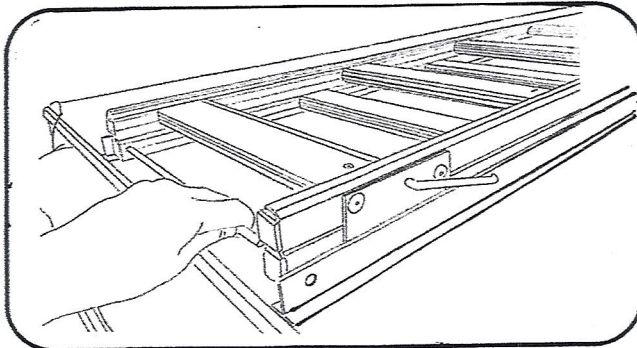

Insert rod through holes of ladder and aluminium.

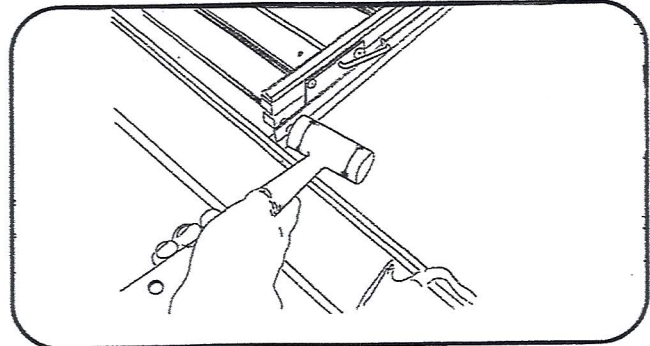

Fix rod by tapping cover-clips to each end.

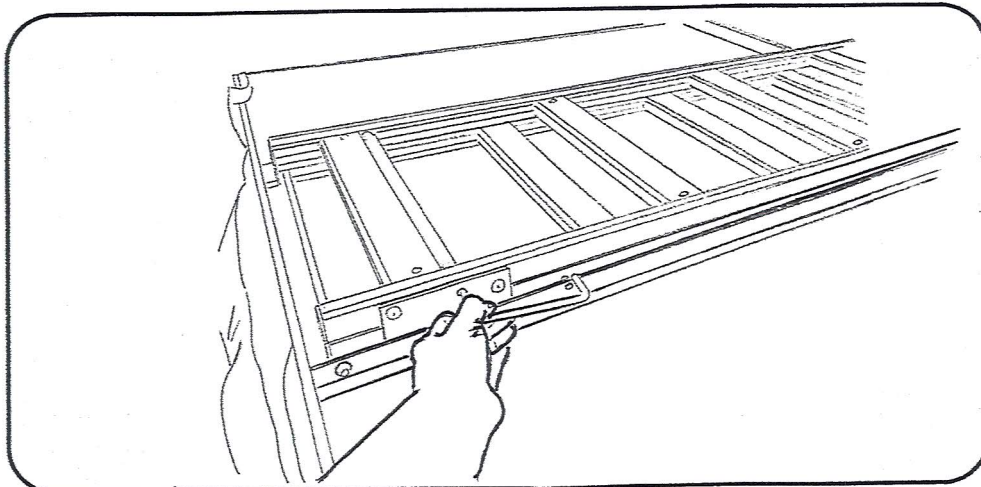

Unlock ladder and slide upper section to full length, relocate in hole provided and lock



ROOFTENT

P.O. Box 68323, Bryanston 2021
 200 Cussonia Park, 3 Ridge Road,
 Laser Park, Honeydew, South Africa.
 Tel: (011) 794-6311 • Fax: (011) 794-6233

OPERATING INSTRUCTIONS

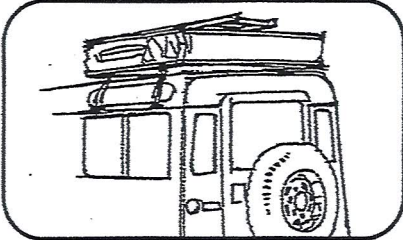

Unlock ladder and slide upper section to full length, relocate in hole provided and lock.

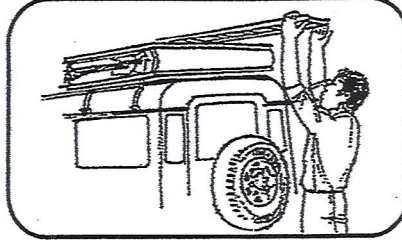

Pull down on fully extended ladder in order to open rooftop.

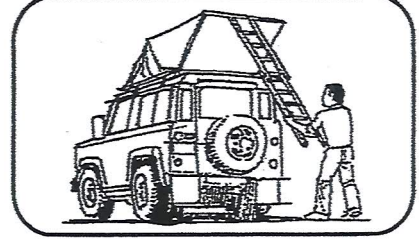

Pull backward to aid unfolding and rest ladder on ground.

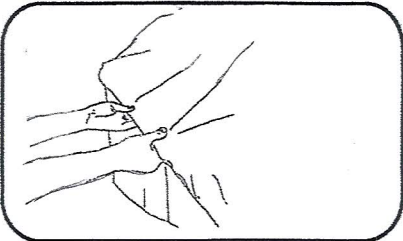

Take hold of aluminium bow and raise into position.

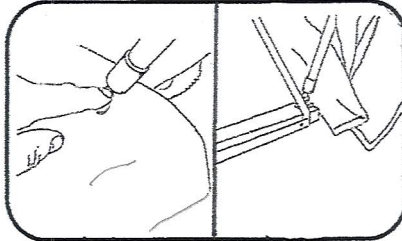

Push ball joint through hole in PVC so as it inserts into socket on the other end.

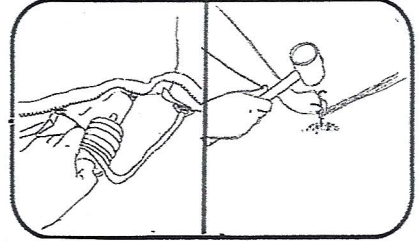

Take rope out of pocket and secure on each side with pegs provided.

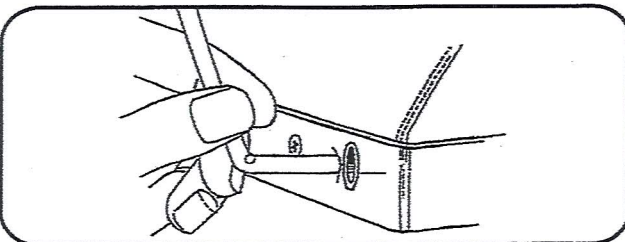

Insert spring steel rods into ferrils of rooftop tent base beading, bend rods and fit into eyelets of rooftop tent side canopies and flysheets.

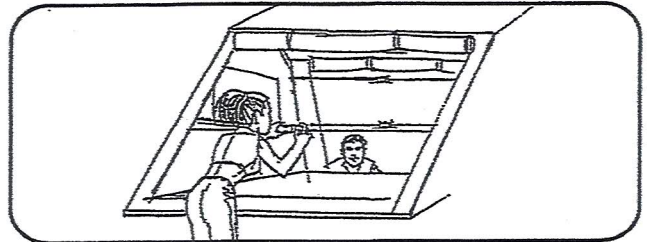

Undo internal plastic clips to release rooftop tent sidewalls.

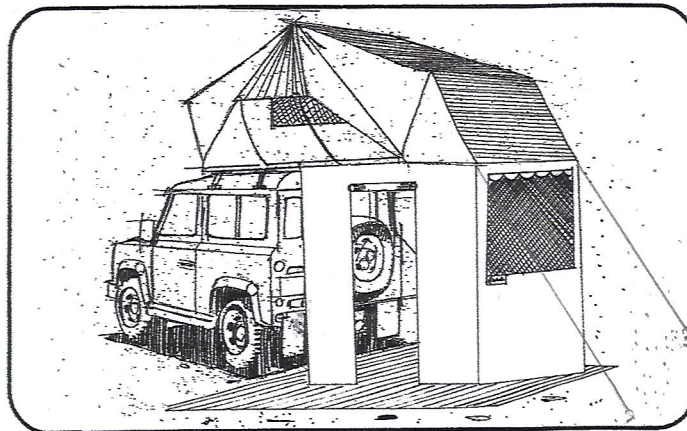

The Skirt sides can be hooked into position now. The Rooftent fully set-up and ready to occupy.



ROOFTENT

OPERATING INSTRUCTIONS TO CLOSE.

PO.BOX 68323 Bryanton 2021
200 Cussonia Park, 3Ridge Road
Laser Park, Honeydew, South Africa
Tel : (011)794-6311 Fax (011)794-6233

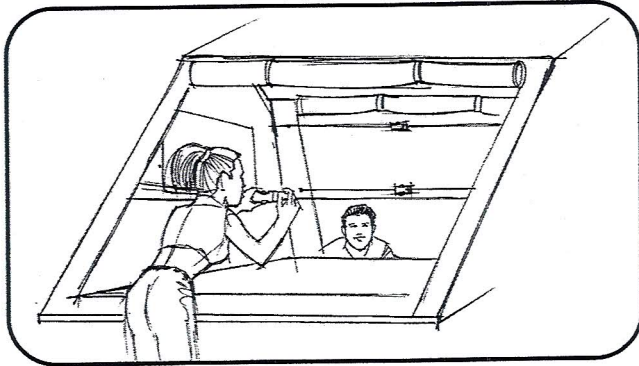

Before closing rooftop, lock plastic clips together to aid folding of rooftop sidewalls .

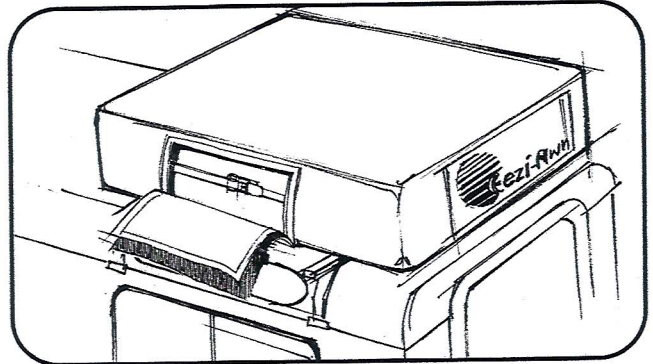

Re-fit travel cover, check that strap is tight across the corners of rooftop base.

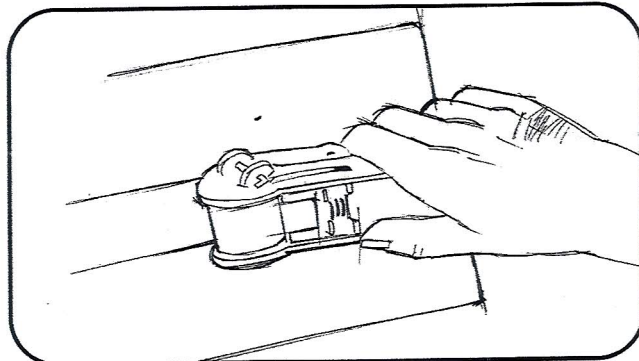

Activate ratchet straps to ensure the travel cover is well secured

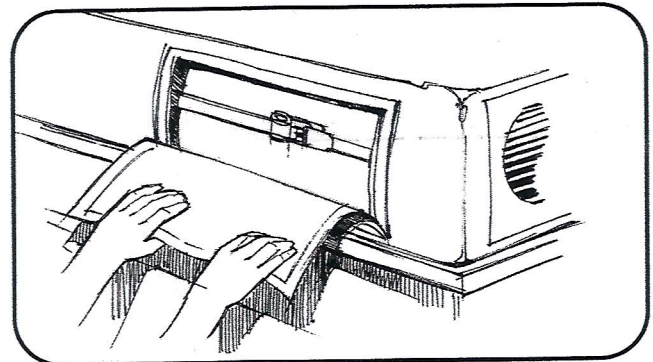

Close ratchet and conceal behind rooftop flap.

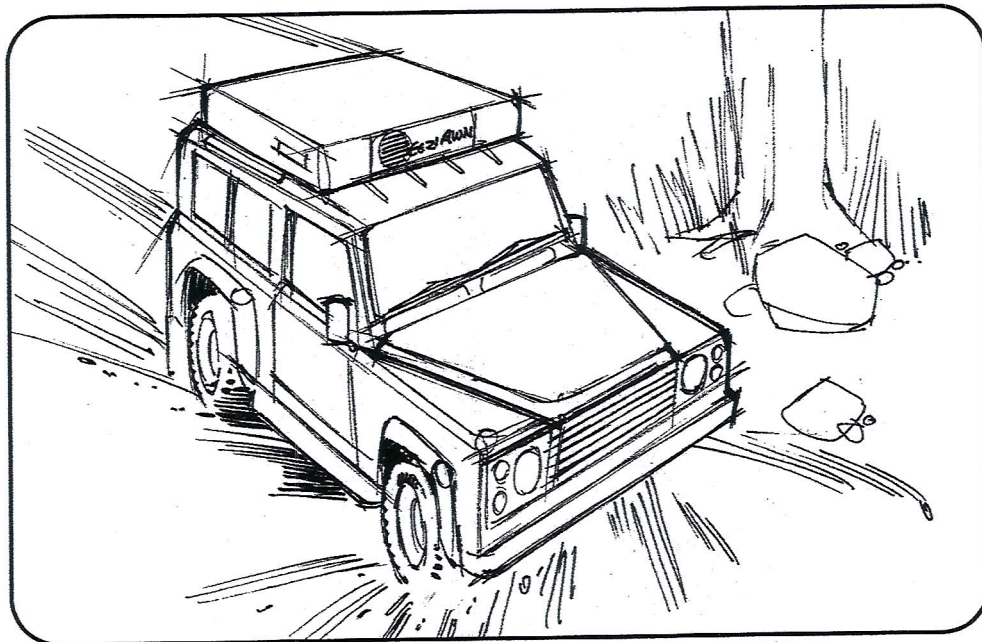

ON THE ROAD AGAIN !! — ENJOY THE RIDE !!



ROOFTENT

INSTALLATION INSTRUCTIONS

PO.BOX 68323 Bryanston 2021
 200 Cussonia Park, Ridge Road
 Laser Park, Honeydew, South Africa
 Tel : (011)794-6311 Fax: (011)7946233

Drop bolt through hole in fixing slide, Insert slide into rail, attached to rooftop base.

Drill hole through roofrack slat or board to accommodate bolt, washer and nyloc-nut supplied.

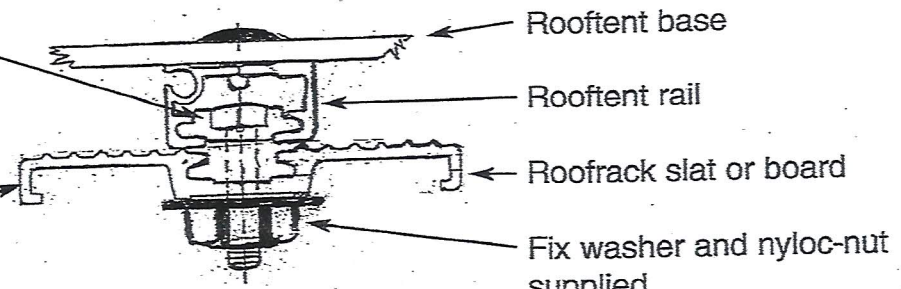

CROSS-SECTION OF INSTALLATION
 ROOFTENT TO ROOFRAK

PLAN VIEW ROOFTENT BASE RAIL CENTRES

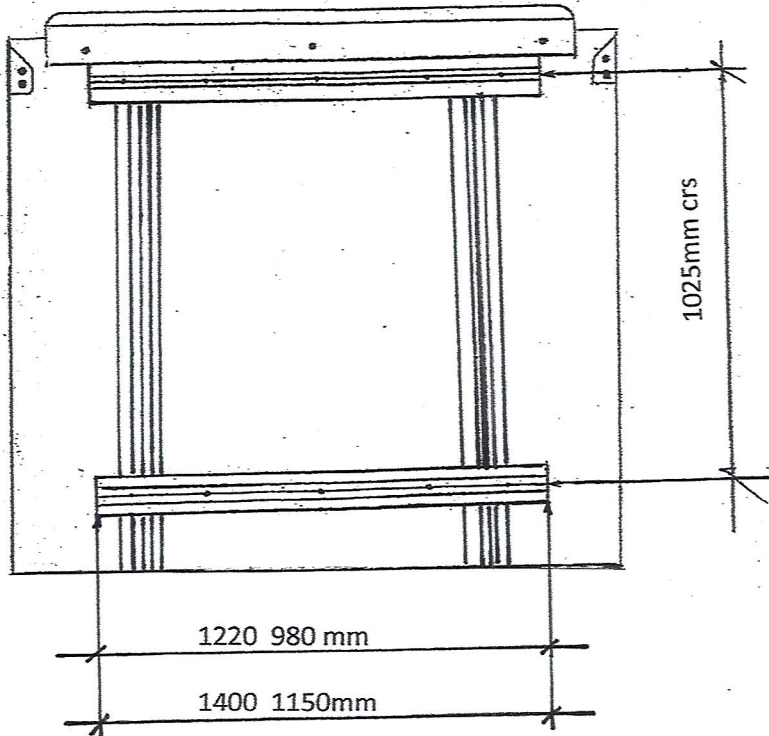

OPTIONAL EXTRAS TO FIT ROOFTENTS

Gutterless rail system to fit rooftents to vehicles without gutters.

Loadbars to fit rooftents onto vehicles with gutters.

Loadbars to fit rooftop tent onto roofrack rails.

Bullbar kits for rooftents that are mounted at the front of vehicle roof racks

PO.BOX 68323 Bryanston 2021
200 Cussonia Park,Ridge Road
Laser Park ,Honeydew.South Africa
Tel :(011)794-6311 Fax:(011)7946233

LADDER HEIGHT ADJUSTMENT INSTRUCTIONS

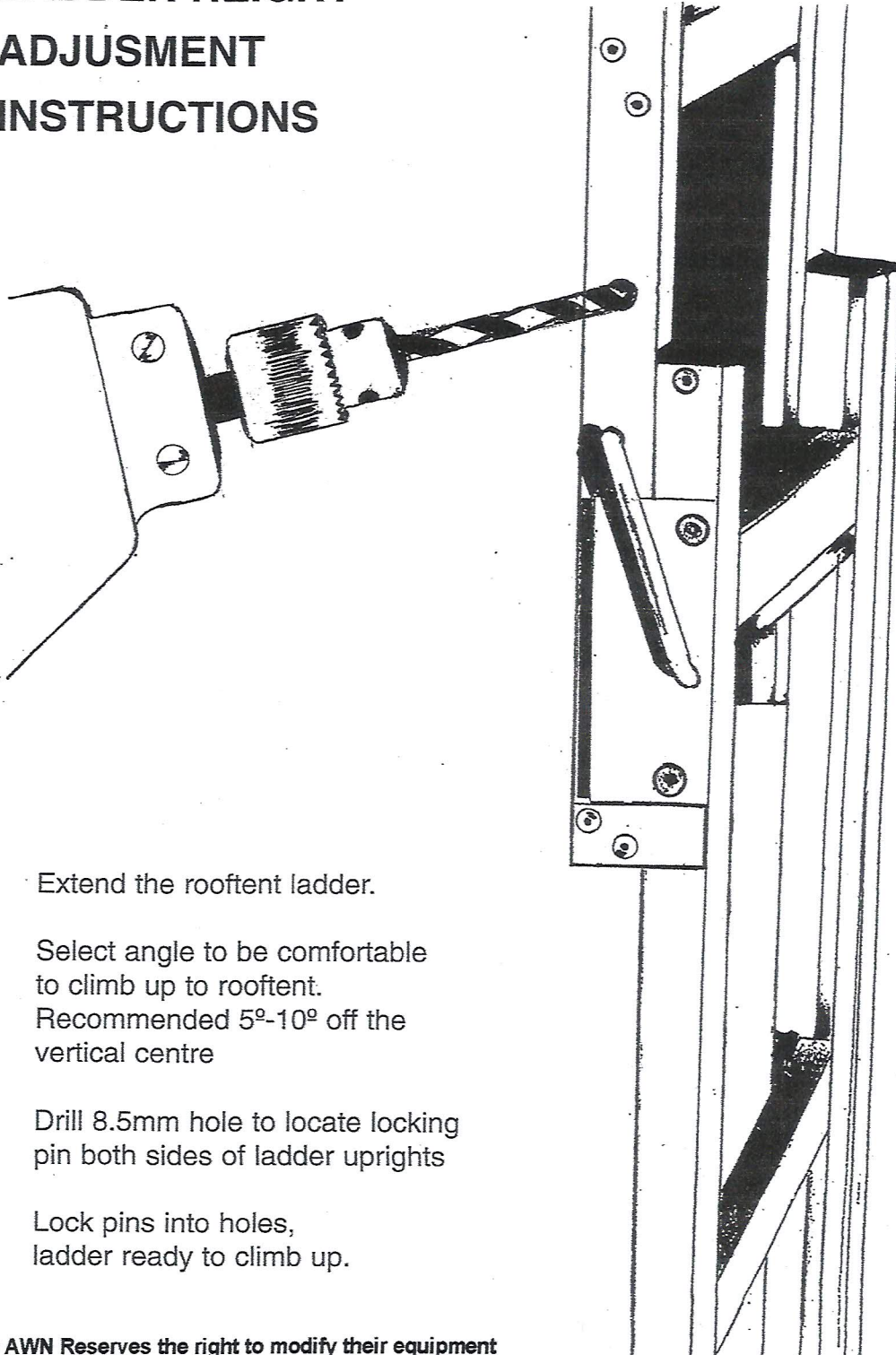

1. Extend the rooftent ladder.
2. Select angle to be comfortable to climb up to rooftent.
Recommended 5° - 10° off the vertical centre
3. Drill 8.5mm hole to locate locking pin both sides of ladder uprights
4. Lock pins into holes, ladder ready to climb up.