

POWER SMART[®]

INSTRUCTION MANUAL

18 inch Electric Chain Saw

Model # PS8218

Item#M1L-KW18-455

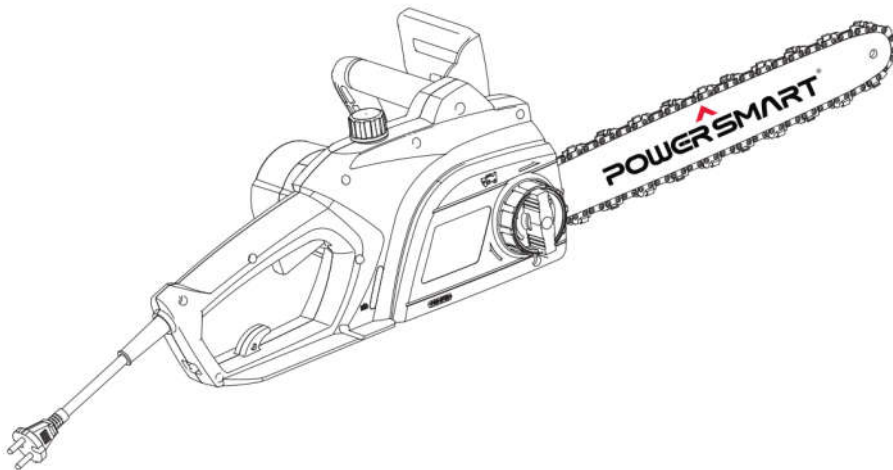

Have product questions or need technical support? Please scan the QR code to enter our official website and contact us!

Website: www.powersmartusa.com

Toll free: 1-800-791-9458 M-F 9-5 EST

Email: support@amerisuninc.com



Website

CONTENTS

Technical data.....	3
Introduction.....	4
Safety information.....	4
General safety procedures	5
Specific safety rules for chain saw.....	8
Symbols.....	9
Knowing your chain saw.....	11
Assembly instructions.....	12
Operation.....	13
Maintenance.....	17
Troubleshooting.....	19
Exploded view & parts list.....	21
Warranty statement.....	24

TECHNICAL DATA

18inch Electric Chain Saw	Model#PS8218
Voltage:	120V~60Hz
Amps:	15A
Bar length:	18"
Max cutting length:	18 in.
Chain pitch:	3/8 in.
Chain gauge:	0.05"
Chain speed:	13.6m/s
Brake time:	< 0.12s
Lubrication oil type:	30W
Oil tank capacity:	8.9 fl.oz
Package dimensions (L x W x H):	19 x 11 x 8.3 inches
G.W. / N.W.:	13.0 lbs / 11.0 lbs

INTRODUCTION

Thank You for Purchasing a PowerSmart® Product. This manual provides information regarding the safe operation and maintenance of this product. Every effort has been made to ensure the accuracy of the information in this manual. PowerSmart® reserves the right to change this product and specifications at any time without prior notice.

Please keep this manual available to all users during the entire life of the chain saw.



This manual contains special messages to bring attention to potential safety concerns, chain saw damage as well as helpful operating and servicing information. Please read all the information carefully to avoid injury and machine damage.

QUESTIONS? PROBLEMS?

Please contact our Customer Service Dept. with any questions and/or comments, either by Email: support@amerisuninc.com, or Toll Free at (800)791-9458. We are available Mon-Fri 9am-5pm EST to help solve any issues that you might encounter.

SAFETY INFORMATION

Before operating this chain saw, read and observe all warnings, cautions, and instructions on the chain saw and in this Owner's Manual.

NOTE: The following safety information is not meant to cover all possible conditions and situations that may occur. Read the entire Owner's Manual for safety and operating instructions. Failure to follow instructions and safety information could result in serious injury or death.

This safety alert symbol is used to identify safety information about hazards that can result in personal injury.



A signal word (DANGER, WARNING, or CAUTION) is used with the alert symbol to indicate the likelihood and the potential severity of injury. In addition, a hazard symbol may be used to represent the type of hazard.

DANGER Indicates a hazard, which, if not avoided, will result in death or serious injury.

WARNING Indicates a hazard, which, if not avoided, could result in death or serious injury.

CAUTION Indicates a hazard, which, if not avoided, might result in minor or moderate injury.

CAUTION Without the alert symbol, indicates a situation that could result in damage.

GENERAL SAFETY PROCEDURES

Safety is a combination of common sense, staying alert, and knowing how your electric chain saw works.

SAVE THESE SAFETY INSTRUCTIONS.



WARNING: Do not operate this unit until you read this instruction manual for safety, operation and maintenance instructions. Failure to follow all instructions listed below may result in electric shock, fire, and/or serious personal injury.

WORK AREA SAFETY

- Keep work area clean and well lit. Cluttered or dark areas invite accidents.
- Do not operate power tools in explosive atmospheres, such as in the presence of flammable liquids, gases or dust. Power tools create sparks which may ignite the dust or fumes.
- Keep children and bystanders away while operating a power tool. Distractions can cause you to lose control.

ELECTRICAL SAFETY

Grounding instructions

IN THE EVENT OF A MALFUNCTION OR BREAKDOWN, grounding provides the path of least resistance for electric current and reduces the risk of electric shock. This tool is equipped with an electric cord that has an equipment grounding conductor and a grounding plug. The plug **MUST** be plugged into a matching outlet that is properly installed and grounded in accordance with **ALL** local codes and ordinances.

DO NOT MODIFY THE PLUG PROVIDED. If it will not fit the outlet, have the proper outlet installed by a licensed electrician.

IMPROPER CONNECTION of the equipment grounding conductor can result in electric shock. The conductor with the green insulation (with or without yellow stripes) is the equipment grounding conductor. If repair or replacement of the electric cord or plug is necessary, **DO NOT** connect the equipment grounding conductor to a live terminal.

CHECK with licensed electrician or service personnel if you do not completely understand the grounding instructions, or if you are not sure if the tool is properly grounded.

USE ONLY THREE-WIRE EXTENSION CORDS that have 3-pronged plugs and outlets that accept the tool's plug as shown in Fig. A. Repair or replace a damaged or worn cord immediately.

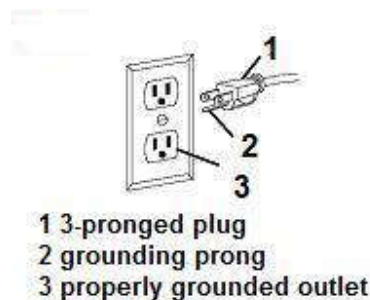

CAUTION: In all cases, make certain the outlet in question is properly grounded. If you are not sure if it is, have a licensed electrician check the outlet.



WARNING: Do not expose to rain or use in damp locations.

Guidelines for using extension cords

Make sure your extension cord is in good condition. When using an extension cord, be sure to use one heavy enough to carry the current your product will draw. An undersized cord will cause a drop in line voltage resulting in loss of power and overheating. The table below shows the correct size to be used according to cord length and nameplate ampere rating. If in doubt, use the next heavier gauge. The smaller the gauge number, the heavier the cord.

Minimum Gauge for Extension Cords (AWG)
(When using 120 V only)

Ampere Rating		Total Length of Cord in feet			
More Than	Not More Than	25	50	100	150
0	6	18	16	16	14
6	10	18	16	14	12
10	12	16	16	14	12
12	16	14	12	Not Recommended	

Make sure your extension cord is properly wired and in good condition. Always replace a damaged extension cord or have it repaired by a qualified person before using it.

Protect your extension cords from sharp objects, excessive heat and damp or wet areas.

Use a separate electrical circuit for your tools. This circuit must not be less than a #12 wire and should be protected with a 15 A time-delayed fuse. Before connecting the motor to the power line, make sure the switch is in the OFF position and the electric current is rated the same as the current stamped on the motor nameplate. Running at a lower voltage will damage the motor.



WARNING: This tool must be grounded while in use to protect the operator from electric shock.

PERSONAL SAFETY

- Stay alert, watch what you are doing and use common sense when operating a power tool. Do not use a power tool while you are tired or under the influence of drugs, alcohol or medication. A moment of inattention while operating power tools may result in serious personal injury.
- Use personal protective equipment. Always wear eye protection. Protective equipment such as dust mask, non-skid safety shoes, hard hat, or hearing protection used for appropriate conditions will reduce personal injuries.

- Prevent unintentional starting. Ensure the switch is in the off-position before connecting to power source and/or battery pack, picking up or carrying the tool. Carrying power tools with your finger on the switch or energising power tools that have the switch on invites accidents.
- Remove any adjusting key or wrench before turning the power tool on. A wrench or a key left attached to a rotating part of the power tool may result in personal injury.
- Do not overreach. Keep proper footing and balance at all times. This enables better control of the power tool in unexpected situations.
- Dress properly. Do not wear loose clothing or jewellery. Keep your hair, clothing, and gloves away from moving parts. Loose clothes, jewellery or long hair can be caught in moving parts.
- If devices are provided for the connection of dust extraction and collection facilities, ensure these are connected and properly used. Use of dust collection can reduce dust-related hazards.

POWER TOOL USE AND CARE

- Do not force the power tool. Use the correct power tool for your application. The correct power tool will do the job better and safer at the rate for which it was designed.
- Do not use the power tool if the switch does not turn it on and off. Any power tool that cannot be controlled with the switch is dangerous and must be repaired.
- Disconnect the plug from the power source and/or the battery pack from the power tool before making any adjustments, changing accessories, or storing power tools. Such preventive safety measures reduce the risk of starting the power tool accidentally.
- Store idle power tools out of the reach of children and do not allow persons unfamiliar with the power tool or these instructions to operate the power tool. Power tools are dangerous in the hands of untrained users.
- Maintain power tools. Check for misalignment or binding of moving parts, breakage of parts and any other condition that may affect the power tool's operation. If damaged, have the power tool repaired before use. Many accidents are caused by poorly maintained power tools.
- Keep cutting tools sharp and clean. Properly maintained cutting tools with sharp cutting edges are less likely to bind and are easier to control.
- Use the power tool, accessories and tool bits etc. in accordance with these instructions, taking into account the working conditions and the work to be performed. Use of the power tool for operations different from those intended could result in a hazardous situation.

SERVICE

- Tool service must be performed only by qualified repair personnel. Service or maintenance performed by unqualified personnel could result in a risk of injury.
- When servicing a tool, use only identical replacement parts. Follow instructions in the Maintenance section of this manual. Use of unauthorized parts or failure to follow Maintenance Instructions may create a risk of electric shock or injury.

SPECIFIC SAFETY RULES FOR CHAIN SAW



WARNING: Do not operate your chain saw until it is completely assembled and installed according to the instructions.

- Keep all parts of the body away from the saw chain when the chain saw is operating. Before you start the chain saw, make sure the saw chain is not contacting anything. A moment of inattention while operating chain saws may cause entanglement of your clothing or body with the saw chain.
- **DANGER – Keep hands away from blade.** Contact with blade will result in serious personal injury.
- Use chain saw for cutting wood only. Do not use for cutting non-wood items.
- Make sure that the area in which you are cutting is free from obstructions. Do not let the nose of the guide bar contact a log, branch, fence, or any other obstruction while you are operating the unit. Have a planned retreat path.
- Do not grasp the exposed cutting blades or cutting edges when picking up or holding the product.
- Cut only when visibility and light are adequate for you to see clearly.
- To protect yourself from electrocution, do not operate within 50 feet of overhead electrical lines.
- Before starting the motor, make sure the chain is not contacting any object.
- Turn off the motor and make sure cutting attachment has stopped before setting unit down.
- Follow the sharpening and maintenance instructions for the saw chain.
- Use only the replacement guide bars and low kickback chains specified for the unit.
- Do not operate the saw with one hand! Serious injury to the operator, helpers, bystanders, or any combination of these persons may result from one hand operation. This saw is intended for two-hand use.
- Use extreme caution when cutting small-sized brush and saplings because slender material may catch the saw chain and be whipped toward you or pull you off balance.
- When cutting a limb that is under tension, be alert for spring back so that you will not be struck when the tension in the wood fibers is released.
- To avoid accidental starting, never carry plugged in product with finger on switch. Be sure switch is off when plugging in.
- Maintain product with care. Keep cutting edge sharp and clean for best performance and to reduce the risk of injury. Follow this instruction for lubricating and changing accessories. Inspect cord periodically and, if damaged, have it repaired by an authorized service facility. Inspect extension cords periodically and replace if damaged. Keep handles dry, clean, and free from oil and grease.
- Remove the battery pack when not in use, before servicing, and when changing accessories.
- Service on the product must be performed by qualified repair personal only. Service or maintenance performed by unqualified personal could result in injury to the user or damage to the product.

PREVENTION OF KICKBACK

Kickback may occur when the nose or tip of the guide bar touches an object, or when the wood closes in and pinches the saw chain in the cut.

Tip contact, in some cases, may cause a sudden reverse reaction, kicking the guide bar up and back towards the operator.

Pinching the saw chain along the top of the guide bar may push the guide bar rapidly back towards the operator.







Either of these reactions may cause you to lose control of the saw which could result in serious personal injury. Do not rely exclusively on the safety devices built into your saw. As a chain saw user, you should take several steps to keep your cutting jobs free from accident and injury.





Kickback is the result of tool misuse and/or incorrect operating procedures or conditions and can be avoided by taking proper precautions as given below:

- Maintain a firm grip with thumbs and fingers encircling the chain saw handles, with both hands on the saw and position your body and arm to allow you to resist kickback forces. Kickback forces can be controlled by the operator, if proper precautions are taken. Do not let go of the chain saw.
- Do not overreach and do not cut above shoulder height. This helps prevent unintended tip contact and enables better control of the chain saw in unexpected situations.
- Follow the sharpening and maintenance instructions for the saw chain. Decreasing the depth gauge height can lead to increased kickback.

SYMBOLS

Some of the following symbols may be used on this product. Please study them and learn their meaning. Proper interpretation of these symbols will allow you to operate the product better and safer.

SYMBOL	NAME	DESIGNATION/EXPLANATION
V	Volts	Voltage
A	Amperes	Current
Hz	Hertz	Frequency (cycles per second)
W	Watts	Power
hrs	Hours	Time
	Double Insulated	Class II construction Double Insulated construction
	Safety Alert	Precautions that involve your safety.
	Read the user's manual	To reduce the risk of injury, user must read and understand user's manual before using this product.
	Ear protection	Wear ear protection when operating this equipment.
	Eye protection	Wear eye protection when operating this equipment.
	Withdraw the mains plug!	Unplug before performing any maintenance.
	Wear hand and foot protection	Wear gloves and appropriate closed-toe work boots when operating the chain saw.

SYMBOL	NAME	DESIGNATION/EXPLANATION
	Wet conditions alert	Do not expose to rain or use in damp locations.
	Avoid bar nose contact	Contact of the guide bar tip with any object should be avoided! Tip contact may cause the guide bar to move suddenly upward and backward, which may cause serious injury!
	No Hands Symbol	Failure to keep your hands away from the saw will result in serious personal injury.
	Operate With Two Hands	Do not use one handed when operating the chain saw. Always use two hands when operating the chain saw.
	Electric shock alert	Beware of electric shock hazard.

SERVICE

Servicing requires extreme care and knowledge and should be performed only by a qualified service technician. For service we suggest you return the product to your nearest **AUTHORIZED SERVICE CENTER** for repair. When servicing, use only identical replacement parts.



WARNING: To avoid serious personal injury, do not attempt to use this product until you have read this Owner's Manual thoroughly and understand it completely. If you do not understand the warnings and instructions in this Owner's Manual, do not use this product. Call the Toll-free Helpline (1-800-791-9458) for assistance.



WARNING:

The operation of any power tool can result in foreign objects being thrown into your eyes, which can result in severe eye damage. Before beginning power tool operation, always wear safety goggles or safety glasses with side shields and, when needed, a full face shield. We recommend Wide Vision Safety Mask for use over eyeglasses or standard safety glasses with side shields. Always use eye protection which is marked to comply with ANSI Z87.1.



SAVE THESE INSTRUCTIONS

KNOWING YOUR CHAIN SAW

Please use the illustration below to familiarize yourself with the location and function of the components that control of your chain saw.

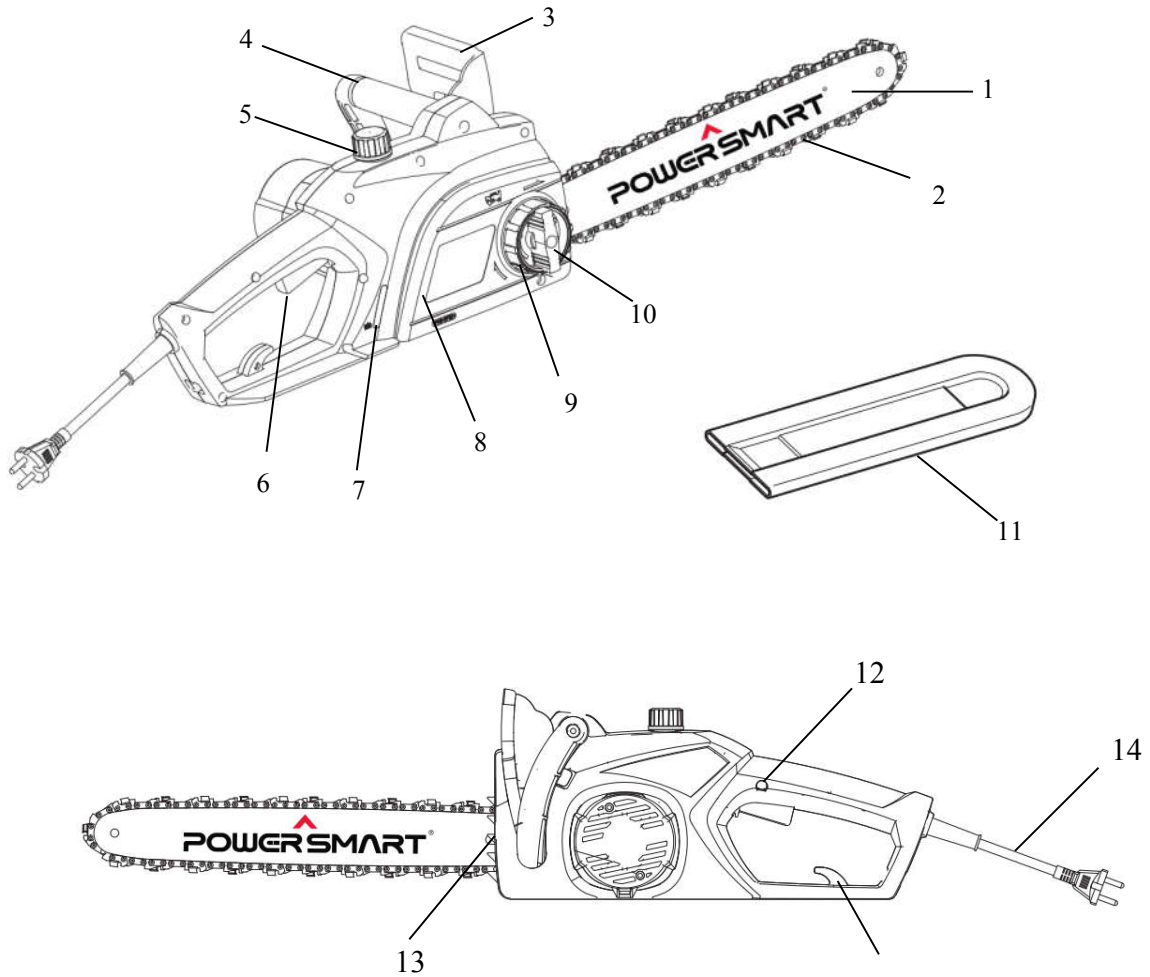

Fig.1

- | | | | | | |
|---|--------------|----|-----------------------|----|-----------------|
| 1 | Guide bar | 6 | Trigger switch | 11 | Guide bar cover |
| 2 | Saw chain | 7 | Oil inspection window | 12 | Lock-off button |
| 3 | Chain brake | 8 | Side cover | 13 | Spike bumper |
| 4 | Front handle | 9 | Chain tensioning ring | 14 | Power cord |
| 5 | Oil tank cap | 10 | Side cover lock knob | 15 | Cord retainer |

Unpacking

Unpack the chain saw and all its parts, and compare against the list below. Do not discard the carton or any packaging materials. Please call 1-800-791-9458 or E-mail us at support@amerisuninc.com if any parts are damaged or missing.

Including: Chain saw / User manual / Saw chain / Guide bar / Scabbard

ASSEMBLY INSTRUCTIONS



WARNING:

Do not use this product if any parts on the packing list are already assembled to your product when you unpack it. Parts on this list are not assembled to the product by the manufacturer and require customer installation. Use of a product that may have been improperly assembled could result in serious personal injury.



WARNING:

If any parts are damaged or missing do not operate this product until the parts are replaced. Use of this product with damaged or missing parts could result in serious personal injury.



WARNING:

Do not attempt to modify this product or create accessories not recommended for use with this product. Any such alteration or modification is misuse and could result in a hazardous condition leading to possible serious personal injury.



WARNING:

Do not connect to power supply until assembly is complete. Failure to comply could result in accidental starting and possible serious personal injury.

FITTING THE GUIDE BAR AND CHAIN



WARNING: Do not connect the chain saw to mains before it is completely assembled. Always use gloves when handling the chain. Wear protective gloves whenever doing any work on the saw chain.

1. Place the chain saw on a flat surface surface.
2. Unscrew the side cover lock knob to remove the side cover.
3. Fit in one end of the saw chain on the top of the guide bar and the other end of it around the sprocket.
4. Place the guide bar with the saw chain on the chain wheel and guide bolt.
5. Holding the guide bar, and turn the chain adjusting dial to adjust the saw chain tension.
6. Place the side cover so that the hooks fit alongside the holes and the pin fits its counterpart on the side cover.
7. Tighten the side cover.

LUBRICATION



CAUTION: The chain saw is not supplied filled with oil. It is essential to fill with oil before use. Never operate the chain saw without chain oil or at an empty oil tank level, as this will result in extensive damage to the product.

Use premium bar and chain lubricant. It is designed for chains and chain oilers, and is formulated to perform over a wide temperature range with no dilution required.



WARNING: Always be sure that the tool is switched off and unplugged before lubricating the saw chain.

To fill the oil, perform the following steps:

1. Place the chain saw on a firm, flat surface so that the oil tank cap is on top.
2. Clean the dust from the oil tank cap and the surroundings.
3. Unscrew the oil tank cap and add oil up to the lower edge of the filler neck.
4. Screw the oil tank cap firmly back in place.
5. Wipe away any spilt chain oil carefully.

NOTE: Do not use dirty, used, or otherwise contaminated lubricants. Damage may occur to the bar or chain.

NOTE: It is normal for oil to seep from the saw when not in use. To prevent seepage, empty the oil tank after each use then run for one minute. When storing the unit for a long period of time(three months or longer) be sure the chain is lightly lubricated; this will prevent rust on the chain and bar sprocket.

OPERATION



WARNING: Read and thoroughly understand all instructions and safety information before operating this chain saw. Failure to do so may cause serious injury or death. Do not allow anyone to operate this chain saw who has not read this manual. A chain saw can be dangerous if assembled or used improperly. Do not operate this chain saw if you have doubts or questions concerning safe operation. Call our customer service department at 1-800-791-9458 to address these concerns.

STARTING THE CHAIN SAW



WARNING: Before plugging in the tool, always check to see that the switch trigger actuates properly and returns to the "OFF" position when released. Check the voltage and current supply. The voltage and current supply must comply with the ratings on the type plate.

Make sure the chain brake is not engaged.

- Grasp the front and rear handles firmly.
- Press and hold the lock-off button with the thumb.
- To start the saw, squeeze the trigger switch. There is no need to continue to press the lock-off button. It will remain disengaged until the trigger is released.

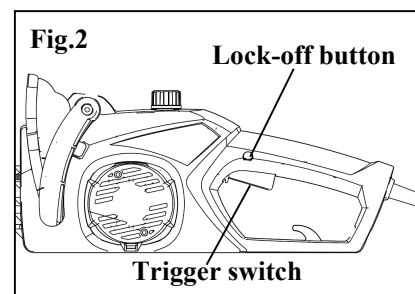

STOPPING THE CHAIN SAW

- Remove the chain saw from the cutting area, release the trigger switch and stop the chain saw.
- Push the chain brake forward to switch it to the braking position (See fig.3).



WARNING: The tool runs for approximately 4 seconds after it has been switched off. Let the motor come to a complete standstill before setting the tool down.

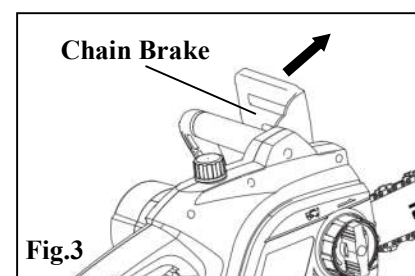

SETTING THE CHAIN BRAKE

Your chain saw is equipped with a motor chain braking system which will stop the chain quickly in case of kickback. After unpacking the chain saw, check the position of the chain brake. The chain saw will not run with the chain brake engaged. Pull the chain brake back towards the front handle before operation.

ADJUSTING CHAIN TENSION



WARNING: Unplug chain saw from power source before adjusting saw chain tension. Cutting edges on chain are sharp. Use protective gloves when handling chain.



WARNING: Maintain proper chain tension always. A loose chain will increase the risk of kickback. A loose chain may jump out of guide bar groove. This may injure operator and damage chain. A loose chain will cause chain, chain bar, and sprocket to wear rapidly.

1. Place the chain saw on any suitable flat surface. The tension is correct when the chain snaps back after being pulled 1/8" (3mm) away from the guide bar with light force from the index finger and thumb. There should be no "sag" between the guide bar and the chain on the underside as shown in Figure 4.

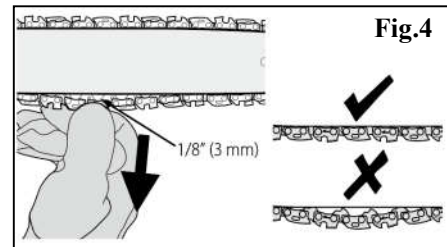

2. To adjust saw chain tension, turn the side cover lock knob counterclockwise one full turn. Then rotate the chain tensioning ring clockwise until the chain tension is correct as instructed above.
3. Do not over-tension the chain as this will lead to excessive wear and will reduce the life of the bar and chain.
4. Once chain tension is correct, securely tighten the side cover lock knob again.

PROPER GRIP ON HANDLES

- Wear non-slip gloves for maximum grip and protection.
- With the saw on a firm, flat surface, hold the saw firmly with both hands.
- Always grasp the front handle with the left hand and the rear handle with the right handle.
- The fingers should encircle the handle, with the thumb wrapped under the front handle.

CUTTING TIPS



WARNING: To reduce the risk of injury, wear proper boots, gloves, head, ear and eye protection.



WARNING: To reduce the risk of electric shock, make sure the cord insulation is intact and that the cord is in a dry location where there is no danger of it being cut or tripped over.



WARNING: To reduce the risk of injury, always be sure of footing and hold the chain saw firmly with both hands while the motor is running.

Cutting logs, branches, etc.

- When cutting timber with the chain saw, the left arm should be kept almost straight. Guide the saw so that no part of your body extends beyond the imaginary line «X» drawn through the guide bar. Press the spiked stop on the saw against the timber and only then start cutting holding the tool by the handle and raising the switch handle (See fig.5).



- When limbing, leave larger lower limbs to support the log off the ground. Remove the small limbs in one cut. Branches under tension should be cut from the bottom up to avoid binding the chain saw (See fig.6).

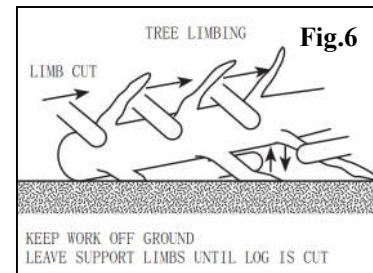

Trimming trees

- Plan retreat paths before beginning to cut, and make sure there are no obstructions. Always know how to get out of the way of falling branches.
- Make sure bystanders or helpers are a safe distance from falling branches. Bystanders or helpers should not stand directly in front of or behind the operator.
- Maintain solid footing and hold the chain saw firmly with both hands. Do not overreach. Never climb a tree or ladder to reach high limbs.
- Secure any branches that might be hazardous.
- Use proper auxiliary equipment.
- Prune lower limbs before pruning higher ones.
- Allow the saw chain to achieve full speed before cutting.
- Apply light pressure to the branch.
- For long limbs, cut the end of the limb first (1) to relieve pressure from the limb, then prune closer to the trunk (2) (See fig.7).
- Thick limbs (greater than 4 inch (10 cm) in diameter) can splinter or pinch the chain when making a single cut from the top. To avoid pinching or splintering, first make one shallow relief cut on the bottom surface of the limb (1), then cut the limb all of the way through from the top of the limb (2) to match the bottom cut (See fig.8).
- After most of the limb has been removed, make one smooth cut near the trunk (See fig.9).

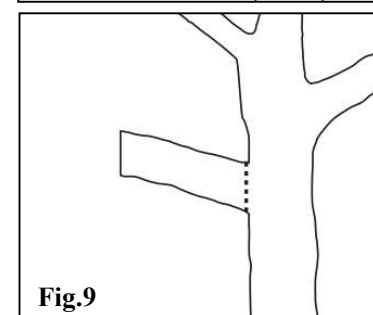
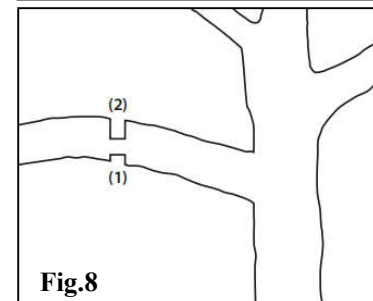
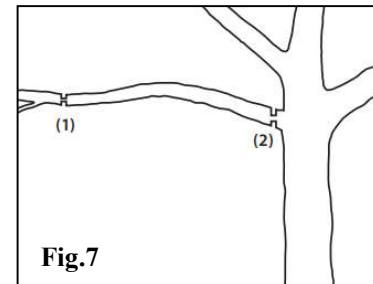

To fell a tree



WARNING: A tree is likely to roll or slide downhill after it is felled.

- Before commencing to cut down a tree, you must be clear where you want it to fall and be sure that there is nothing in the way, such as power lines or a building that could be damaged when the tree falls. NO person or animal must be within 2 1/2 tree lengths of the base of the tree concerned.

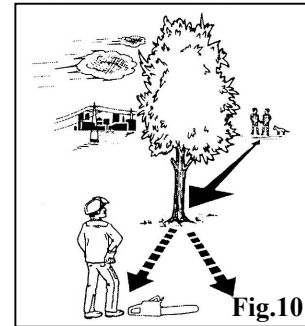

- You should clear two escape routes. Each opening put at an angle of about 45° in the direction opposite to that in which you plan that the tree should fall. These escape routes must be clear and free of obstruction (See fig. 11).

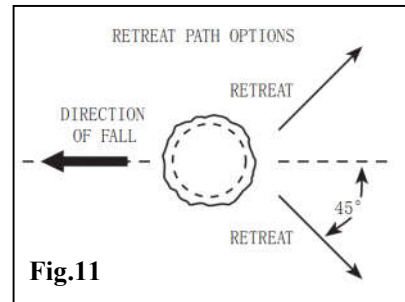

- First, make the notch 1/3 the diameter of the tree perpendicular to the direction of fall. Make the lower horizontal notching undercut first (1). This will help to avoid pinching of either the saw chain or the guide bar when the second cut (2) is being made (See fig. 12).

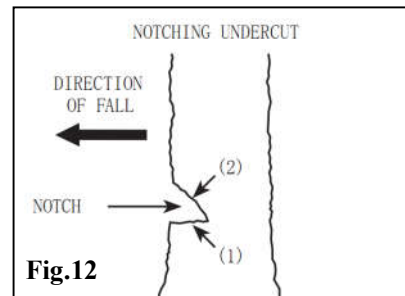

- Second, make the felling back cut at least 2 in (50 mm) higher than the horizontal notching undercut. Keep the felling back cut parallel to the horizontal notching undercut (See fig. 13).
- Make the felling back cut so enough wood is left to act as a hinge. The hinge wood keeps the tree from twisting and falling in the wrong direction. Do not cut through the hinge.
- As the felling cut gets close to the hinge, the tree should begin to fall.

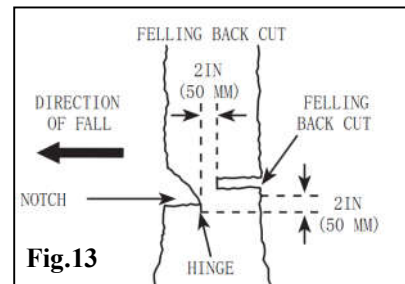

- If there is any chance that the tree may not fall in the desired direction or it may rock back and bind the saw chain, stop cutting before the felling back cut is complete and use wedges of wood, plastic or aluminum to open the cut and drop the tree along the desired line of fall.
- When the tree begins to fall, remove the chain saw from the cut, stop the motor, put the chain saw down, then use the retreat path planned.
- Be alert for overhead limbs falling and watch footing.

MAINTENANCE



WARNING:

In order to avoid personal injury and the risk of fire and electric shock, unplug chain saw for power source before adjusting, inspecting, or cleaning the chain saw.



WARNING:

When servicing, use only identical replacement parts. Use of any other parts could create a hazard or cause product damage.

CLEANING



WARNING: Avoid using solvents when cleaning plastic parts. Most plastics are susceptible to damage from various types of commercial solvents and may be damaged by their use. Use clean clothes to remove dirt, dust, oil, grease, etc.

Wear gloves.

- Unplug the chain saw.
- Remove wood chips and other debris from the motor housing and the vents.
- Always clean out wood chips, saw dust and dirt from the bar groove when replacing the chain.
- Make sure the cord and plug are dry before connecting to an outlet.

SHARPENING SAW CHAIN



WARNING: Unplug chain saw from power source before servicing. Severe injury or death could occur from electrical shock or body contact with moving chain. Cutting edges on chain are sharp. Use protective gloves when handling chain.

Keep chain sharp. Your saw will cut faster and more safely. A dull chain will cause undue sprocket, guide bar, chain, and motor wear. If you must force chain into wood and cutting creates only sawdust with few large chips, chain is dull.

GUIDE BAR MAINTENANCE

When the guide bar shows signs of wear, reverse it on the saw to distribute the wear for maximum bar life. The bar should be cleaned every day of use and checked for wear and damage.

Feathering or burring of the bar rails is a normal process of bar wear. Such faults should be smoothed with a file as soon as they occur.

A bar with any of the following faults should be replaced.

- Wear inside the bar rails which permits the chain to lay over sideways.
- Bent guide bar.
- Cracked or broken rails.
- Spread rails.

Lubricate guide bars with a sprocket at their tip weekly. Using a grease syringe, lubricate weekly in the lubricating hole. Turn the guide bar and check that the lubrication holes and chain groove are free from impurities.

REPLACING THE BAR AND CHAIN



WARNING:

To avoid possible serious injury, stop the motor and disconnect from power supply before replacing the bar, chain, or performing any maintenance operation.



CAUTION:

Always wear gloves when handling the bar and chain; these components are sharp and may contain burrs.

1. Unplug the chain saw.
2. Release the side cover lock knob counterclockwise and open the side cover.
3. Rotate the disk wheel at the rear end of the guide plate counter-clockwise and remove the guide bar and the saw chain.
4. Install the saw chain in the guide slot on the guide bar. The chain must be so fitted over the guide bar that the cutting edges of the cutters face in the direction that the chain runs.
5. Grasp the guide bar and the saw chain so that the centre hole of the disk wheel is inserted into the screw stud, and lop the saw chain onto the sprocket.
6. Cover the side cover and tight the side cover lock knob properly but do not make it too tight.
7. Rotate the chain tensioning ring clockwise until the saw chain is tight enough (see the description of adjusting chain tension section).
8. Tighten the side cover lock knob.

STORAGE

- Store out of the reach of children.
- Clean all foreign material from the product. Store idle unit indoors in a dry, well-ventilated area that is inaccessible to children. Keep away from corrosive agents such as garden chemicals and de-icing salts.

TROUBLE SHOOTING

The following form lists the common operating system with problem and solutions. Please read the form carefully and follow it.

PROBLEMS	POSSIBLE CAUSES	SOLUTION
Motor does not run.	<ul style="list-style-type: none"> · Saw is not plugged in. · Cord is damaged or severed. · Bad electrical outlet. · The lock-off button is not depressed before pressing the trigger switch. · Chain brake is engaged. · Saw chain is bound in the wood. · Debris in bar groove. · Debris inside cover. 	<ul style="list-style-type: none"> · Plug in the saw. · If extension cord is damaged, do not use and replace it. If chain saw cord is damaged, do not use and contact an approved service location. · Plug extension cord into a different outlet. · Press down the lock-off button and hold it, then depress the trigger switch to turn on the chain saw. · Pull the chain kickback brake handle backward toward the front handle. · Release the trigger switch; remove the saw chain and guide bar from the wood, then restart the chain saw. · Press the saw chain against the wood, move the chain saw back and forth to discharge the debris. · Unplug the power source, then remove side cover and clean out debris.
Motor runs, but chain does not rotate.	<ul style="list-style-type: none"> · Chain does not engage drive sprocket. · Guide bar nose sprocket 	<ul style="list-style-type: none"> · Reinstall the chain, making sure that the drive links on the chain are fully seated on the sprocket. · Replace the guide bar.
Chain brake does not engage.	<ul style="list-style-type: none"> · Debris preventing full movement of the chain kickback brake handle. · Possible chain brake malfunction 	<ul style="list-style-type: none"> · Clean debris from extremal chain brake mechanism. · WARNING: OPERATING A CHAIN SAW WITHOUT A FUNCTIONING CHAIN BRAKE COULD LEAD TO SERIOUS PERSONAL INJURY. Contact an approved service location before using.

PROBLEMS	POSSIBLE CAUSES	SOLUTION
Chain saw does not cut properly.	<ul style="list-style-type: none"> · Insufficient chain tension. · Dull chain. · Chain installed backwards. · Worm chain. · Dry or excessively stretched chain. · Chain not in bar groove 	<ul style="list-style-type: none"> · Readjust the chain tension, following the section: "CHAIN TENSION". · Reinstall the saw chain, following the section: "REPLACING THE BAR AND CHAIN". · Replace the chain, following the section: "REPLACING THE BAR AND CHAIN". · Check the oil level. Refill the oil tank if necessary. · Reinstall the saw chain, following the section: "REPLACING THE BAR AND CHAIN".
Bar and chain running hot and smoking.	<ul style="list-style-type: none"> · Check chain tension for over tightened condition. · Chain oil tank is empty. · Debris in guide bar groove. 	<ul style="list-style-type: none"> · Re-tension the saw chain; see the section: "CHAIN TENSION". · Filling bar and chain lubricant. · Clear the debris in the groove.

EXPLODED VIEW & PARTS LIST

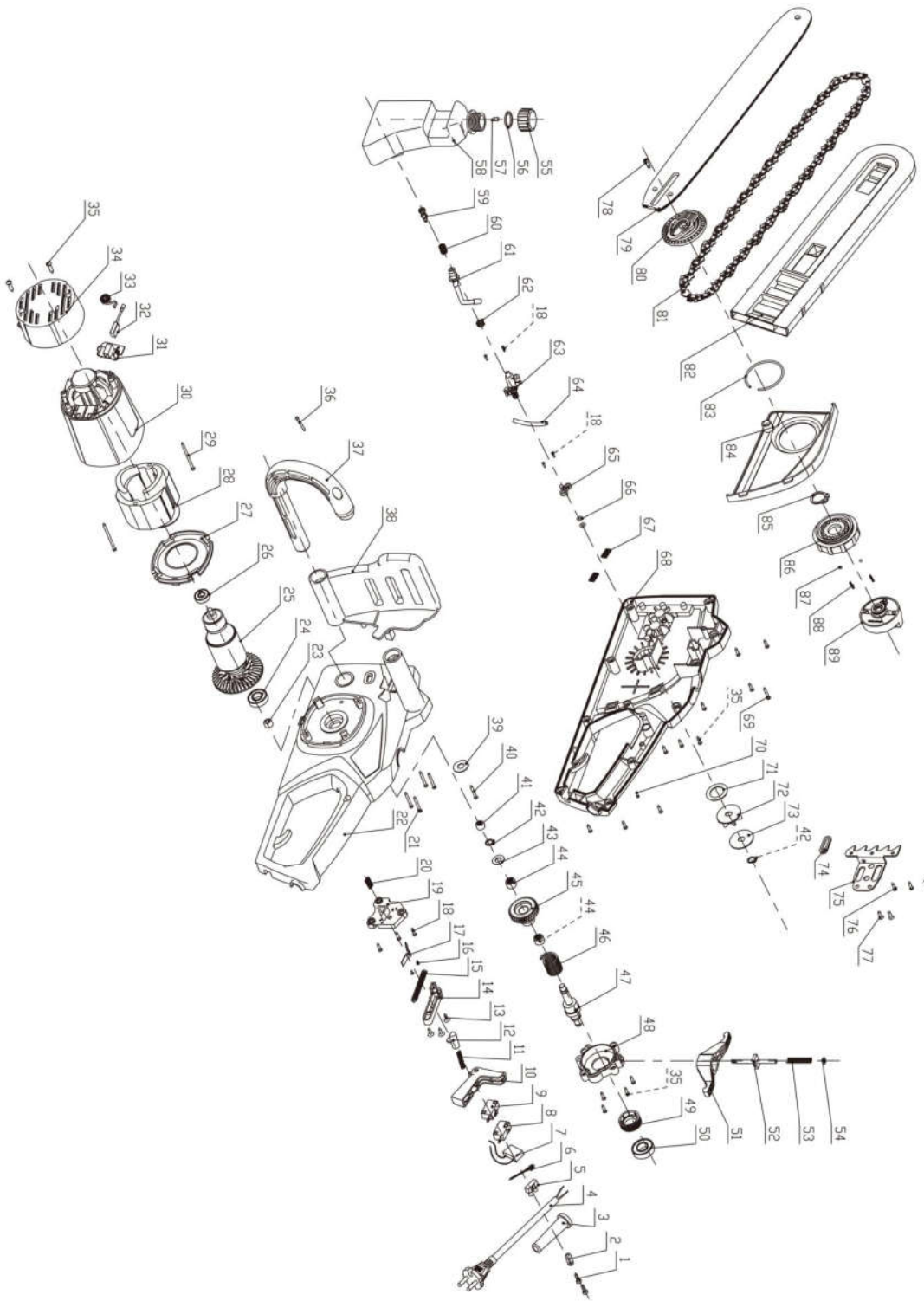

Item	Stock#	Description	Qty.
1	PS8218-001	Screw	2
2	PS8218-002	Tension disc	1
3	PS8218-003	Sheath	1
4	PS8218-004	Power cord	1
5	PS8218-005	Wiring terminal	1
6	PS8218-006	Lead wire	1
7	PS8218-007	Capacitance	1
8	PS8218-008	Switch	1
9	PS8218-009	Switch	1
10	PS8218-010	Trigger	1
11	PS8218-011	Spring	1
12	PS8218-012	Self-locking button	1
13	PS8218-013	Screw	3
14	PS8218-014	Push rod	1
15	PS8218-015	Push rod spring	1
16	PS8218-016	Screw	2
17	PS8218-017	Brake spring	1
18	PS8218-018	Screw	7
19	PS8218-019	Fixed plate	1
20	PS8218-020	Sponge block	1
21	PS8218-021	Screw	4
22	PS8218-022	Left handle	1
23	PS8218-023	Plastic gear ferrule	1
24	PS8218-024	Deep groove ball bearing	1
25	PS8218-025	Rotor	1
26	PS8218-026	Deep groove ball bearing	1
27	PS8218-027	Windshield	1
28	PS8218-028	Stator	1
29	PS8218-029	Screw	2
30	PS8218-030	Motor casing	1

Item	Stock#	Description	Qty.
31	PS8218-031	Brush carrier	2
32	PS8218-032	Carbon brush	2
33	PS8218-033	Coil spring	2
34	PS8218-034	Rear motor cover	1
35	PS8218-035	Screw	16
36	PS8218-036	Screw	1
37	PS8218-037	Front handle	1
38	PS8218-038	Brake baffle	1
39	PS8218-039	Big gasket	1
40	PS8218-040	Screw	1
41	PS8218-041	Needle bearing	1
42	PS8218-042	Shaft ring	2
43	PS8218-043	Big gear ring	1
44	PS8218-044	Needle bearing	2
45	PS8218-045	Big gear wheel	1
46	PS8218-046	Torsional spring	1
47	PS8218-047	Output shaft	1
48	PS8218-048	Gear cover	1
49	PS8218-049	Worm gear	1
50	PS8218-050	Deep groove ball bearing	1
51	PS8218-051	Brake block	1
52	PS8218-052	Brake rod	1
53	PS8218-053	Brake spring	1
54	PS8218-054	Flat gasket	1
55	PS8218-055	Oil tank cap	1
56	PS8218-056	Flat gasket	1
57	PS8218-057	Air breather	1
58	PS8218-058	Oiler	1
59	PS8218-059	Filter tip	1
60	PS8218-060	Spring	1

Item	Stock#	Description	Qty.
61	PS8218-061	Oil inlet tube	1
62	PS8218-062	Spring	1
63	PS8218-063	Oil pump assy	1
64	PS8218-064	Oil outlet tube	1
65	PS8218-065	Oil nozzle	1
66	PS8218-066	O-ring	2
67	PS8218-067	Sponge bar	2
68	PS8218-068	Right handle	1
69	PS8218-069	Screw	1
70	PS8218-070	Screw	1
71	PS8218-071	Felt washer	1
72	PS8218-072	Sprocket	1
73	PS8218-073	Sprocket gasket	1
74	PS8218-074	Oring seal	1
75	PS8218-075	Holder	1

Item	Stock#	Description	Qty.
76	PS8218-076	Screw	3
77	PS8218-077	Screw	2
78	PS8218-078	Screw	1
79	PS8218-079	Bar	1
80	PS8218-080	Adjustment subassembly	1
81	PS8218-081	Chain	1
82	PS8218-082	Bar cover	1
83	PS8218-083	Wire spring	1
84	PS8218-084	Side cover	1
85	PS8218-085	Shaft ring	1
86	PS8218-086	Adjusting ring	1
87	PS8218-087	Steel ball	2
88	PS8218-088	Little spring	2
89	PS8218-089	Compression knob	1

TWO (2) YEARS LIMITED WARRANTY

PowerSmart® is committed to building tools that are dependable for years. Our warranties are consistent with our commitment and dedication to quality.

TWO (2) YEARS LIMITED WARRANTY OF POWER SMART PRODUCTS FOR HOME USE.

PowerSmart ("Seller") warrants to the original purchaser only, that all PowerSmart consumer power tools will be free from defects in material or workmanship for a period of two (2) years from date of purchase. Ninety (90) days for all Power Smart Products, if the tool is used for professional or commercial use.

SELLER'S SOLE OBLIGATION AND YOUR EXCLUSIVE REMEDY under this Two (2) Years Limited Warranty and, to the extent permitted by law, any warranty or condition implied by law, shall be the repair or replacement of parts, without charge, which are defective in material or workmanship and which have not been misused, carelessly handled, or misrepaired by persons other than Seller or Authorized Service Center. To make a claim under this Limited Warranty, you must return the entire power tool product; transportation prepaid, to Power Smart Include a legible copy of the original receipt, which lists the date of purchase (month and year) and the name of the company purchased from.

THIS LIMITED WARRANTY DOES NOT APPLY TO ANY ACCESSORY ITEMS INCLUDED WITH THE TOOL SUCH AS CIRCULAR SAW BLADES OTHER RELATED ITEMS OR TO ANY REPLACEMENT PARTS LISTED UNDER MAINTENANCE.

ANY IMPLIED WARRANTIES SHALL BE LIMITED IN DURATION TO TWO (2) YEARS FROM DATE OF PURCHASE. SOME STATES IN THE U.S. AND SOME CANADIAN PROVINCES DO NOT ALLOW LIMITATIONS ON HOW LONG AN IMPLIED WARRANTY LASTS, SO THE ABOVE LIMITATION MAY NOT APPLY TO YOU.

IN NO EVENT SHALL SELLER BE LIABLE FOR ANY INCIDENTAL OR CONSEQUENTIAL DAMAGES (INCLUDING BUT NOT LIMITED TO LIABILITY FOR LOSS OF PROFITS) ARISING FROM THE SALE OR USE OF THIS PRODUCT. SOME STATES IN THE U.S. AND SOME CANADIAN PROVINCES DO NOT ALLOW THE EXCLUSION OR LIMITATION OF INCIDENTAL OR CONSEQUENTIAL DAMAGES, SO THE ABOVE LIMITATION OR EXCLUSION MAY NOT APPLY TO YOU.

THIS LIMITED WARRANTY GIVES YOU SPECIFIC LEGAL RIGHTS, AND YOU MAY ALSO HAVE OTHER RIGHTS WHICH VARY FROM STATE TO STATE IN THE U.S., PROVINCE TO PROVINCE IN CANADA AND FROM COUNTRY TO COUNTRY.

For questions / comments, technical assistance or repair parts –
Please call toll free at: 1-800-791-9458 (M-F 9am – 5pm EST)
Email: support@amerisuninc.com

SAVE YOUR RECEIPTS. THIS WARRANTY IS VOID WITHOUT THEM.