

# POWERSMART<sup>®</sup>

## INSTRUCTION MANUAL

### 20V Cordless Blower

Model # PS76101A



Have product questions or need technical support? Please feel free to contact us!

Website: [www.Amerisuninc.com](http://www.Amerisuninc.com)  
[www.powersmartusa.com](http://www.powersmartusa.com)

Toll free: 1-800-791-9458 M-F 9-5 EST

Email: [support@amerisuninc.com](mailto:support@amerisuninc.com)



## **CONTENTS**

Technical data.....	3
Introduction.....	4
Safety information.....	4
General safety rules.....	5
Symbols.....	9
Knowing your blower.....	10
Assembly instruction.....	11
Operating instruction.....	12
Maintenance.....	13
Environmentally safe battery disposal.....	14
Troubleshooting.....	14
Exploded view & parts list.....	15
Warranty.....	17

## **TECHNICAL DATA**

20V Cordless Blower	Model # PS76101A
Power input:	20V
Blower speed:	117MPH
No-load speed:	13500 RPM
Battery type:	20V Lithium-ion
Battery model:	PS76018B
Charging time:	1 hour
Charger model:	PS76018C
Charger rating:	Input: 120VAC,60Hz, 0.54A; Output: 20V DC,1.5A
Package dimensions (L x W x H):	18.5 x7.5 x6.5 inches
Weight:	6.4 lb.

## **INTRODUCTION**

Thank You for Purchasing a PowerSmart® Product. This manual provides information regarding the safe operation and maintenance of this product. Every effort has been made to ensure the accuracy of the information in this manual. PowerSmart® reserves the right to change this product and specifications at any time without prior notice.

Please keep this manual available to all users during the entire life of the power tool.



This manual contains special messages to bring attention to potential safety concerns, power tool damage as well as helpful operating and servicing information. Please read all the information carefully to avoid injury and machine damage.

### **QUESTIONS? PROBLEMS?**

Please contact our Customer Service Dept. with any questions and/or comments, either by Email: support@amerisuninc.com, or Toll Free at (800)791-9458. We are available Mon-Fri 9am-5pm EST to help solve any issues that you might encounter.

## **SAFETY INFORMATION**

Before operating this power tool, read and observe all warnings, cautions, and instructions on the power tool and in this Owner's Manual.

NOTE: The following safety information is not meant to cover all possible conditions and situations that may occur. Read the entire Owner's Manual for safety and operating instructions. Failure to follow instructions and safety information could result in serious injury or death.

This safety alert symbol is used to identify safety information about hazards that can result in personal injury.



A signal word (DANGER, WARNING, or CAUTION) is used with the alert symbol to indicate the likelihood and the potential severity of injury. In addition, a hazard symbol may be used to represent the type of hazard.

**DANGER** Indicates a hazard, which, if not avoided, will result in death or serious injury.

**WARNING** Indicates a hazard, which, if not avoided, could result in death or serious injury.

**CAUTION** Indicates a hazard, which, if not avoided, might result in minor or moderate injury.

**CAUTION** Without the alert symbol, indicates a situation that could result in damage.

## **GENERAL SAFETY RULES**

Safety is a combination of common sense, staying alert, and knowing how your blower works.  
**SAVE THESE SAFETY INSTRUCTIONS.**



**WARNING:** Do not operate this unit until you read this instruction manual for safety, operation and maintenance instructions. Failure to follow all instructions listed below may result in electric shock, fire, and/or serious personal injury.

- Do not operate power tools in explosive atmospheres, such as in the presence of flammable liquids, gases, or dust. Power tools create sparks which may ignite the dust or fumes.
- Do not allow children or untrained individuals to use this unit.
- Don't expose battery tools to rain or wet conditions. Water entering a battery tool will increase the risk of electric shock.
- Do not handle plug or tool with wet hands.
- Never allow children to operate the equipment. Never allow adults to operate the equipment without proper instruction.
- Always wear safety glasses with side shields that comply with ANSI Z87.1. Everyday glasses have only impact resistant lenses. They are NOT safety glasses. Following this rule will reduce the risk of eye injury. Use face mask if operation is dusty.
- Wear eye protection when operating this product. Secure long hair above shoulder level to prevent entanglement in moving parts.
- Use extra care when cleaning on stairs.
- Do not expose to rain, store indoors.
- Do not operate in poor lighting.
- Keep all parts of your body away from any moving part.
- Keep hair, loose clothing, fingers and all body parts away from openings and moving parts.
- Wear heavy long pants, boots, and gloves. Avoid loose garments and jewelry that could get caught in moving parts of the machine or its motor.
- Do not force tool. Use the correct tool for your application. The correct tool will do the job better and safer at the rate for which it is designed.
- Do not operate the equipment while barefoot or when wearing sandals or similar lightweight footwear. Wear protective footwear that will protect your feet and improve your footing on slippery surfaces.
- Secure long hair so it is above shoulder level to prevent entanglement in any moving parts.
- Keep firm footing and balance. Do not overreach. Overreaching can result in loss of balance.
- Do not allow to be used as a toy. Close attention is necessary when used by or near children.
- Do not use tool if switch does not turn it on or off. Any tool that cannot be controlled with the switch is dangerous and must be repaired.
- Keep all bystanders, children, and pets at least 50 ft. away.

- Do not operate this unit when you are tired, ill, or under the influence of alcohol, drugs, or medication.
- Keep all parts of your body away from any moving parts and all hot surfaces of the unit.
- Do not put any object into openings. Do not use with any opening blocked; keep openings free of dust, lint, hair, and anything that may reduce air flow.
- Check the work area before each use. Remove all objects such as rocks, broken glass, nails, wire, or string which can be thrown or become entangled in the machine.
- Use only identical manufacturer's replacement parts and accessories. Use of any other parts may create a hazard or cause product damage.
- Do not charge battery tool in rain, or damp or wet location. Following this rule will reduce the risk of electric shock.
- For household use only.
- Battery tools do not have to be plugged into an electrical outlet; therefore, they are always in operating condition. Be aware of possible hazards when not using your battery tool or when changing accessories. Following this rule will reduce the risk of electric shock, fire, or serious personal injury.
- Remove or disconnect battery before servicing, cleaning or removing material from the gardening appliance.
- Use only POWER SMART battery (Model#PS76018B)
- Store idle appliances - When not in use, blower should be stored indoors in a dry, locked place out of the reach of children.
- Do not dispose of the batteries in a fire. The cell may explode. Check with local codes for possible special disposal instructions.
- Do not open or mutilate the batteries. Released electrolyte is corrosive and may cause damage to the eyes or skin. It may be toxic if swallowed.
- Do not place battery tools or their batteries near fire or heat. This will reduce the risk of explosion and possibly injury.
- Batteries can explode in the presence of a source of ignition, such as a pilot light. To reduce the risk of serious personal injury, never use any cordless product in the presence of open flame. An exploded battery can propel debris and chemicals. If exposed, flush with water immediately.
- Do not crush, drop or damage battery pack. Do not use a battery pack or charger that has been dropped or received a sharp blow. A damaged battery is subject to explosion. Properly dispose of a dropped or damaged battery immediately.
- Exercise care in handling batteries in order not to short the battery with conducting materials such as rings, bracelets, and keys. The battery or conductor may overheat and cause burns. Do not open or mutilate the batteries. Released electrolyte is corrosive and may cause damage to the eyes or skin. It may be toxic if swallowed.
- For best results, your battery tool should be charged in a location where the temperature is more than 45°F but less than 104°F. To reduce the risk of serious personal injury, do not store outside or in vehicles.
- Under extreme usage or temperature conditions, battery leakage may occur. If liquid comes in contact with your skin, wash immediately with soap and water, then neutralize with lemon juice or

vinegar. If liquid gets into your eyes, flush them with clean water for at least 10 minutes, then seek immediate medical attention. Following this rule will reduce the risk of serious personal injury.

- If the power supply cord is damaged, it must be replaced only by the manufacturer or by an authorized service center to avoid risk.
- Do not point the blower nozzle in the direction of people or pets.
- Never run the unit without the proper equipment attached. Always ensure the sweeper tubes are installed.
- Maintain tool with care. Keep fan area clean for best and safest performance. Follow instructions for proper maintenance. Do not attempt to clear clogs from tool without first removing the battery.
- To reduce the risk of electrical shock, do not expose to rain, do not use on wet surfaces. Store indoors.
- Save these instructions. Refer to them frequently and use them to instruct others who may use this battery tool. If you loan someone this battery tool, loan them these instructions also.

## CHILD SAFETY

Tragic accidents can occur if the operator is not aware of the presence of children.

- Keep children out of the working area and under the watchful care of a responsible adult.
- Do not allow children under the age of 14 to operate this blower. Children who are 14 years of age and older must read and understand the operating instructions and safety rules in this manual, and must be trained and supervised by a parent.
- Stay alert, and turn the blower off if a child or any other person enters the mowing area.
- Use extreme care when approaching blind corners, doorways, shrubs, trees, or other objects that may obscure your view of a child who may run into the path of the blower.



### **WARNING:**

Some dust created by power sanding, sawing, grinding, drilling and other construction activities contains chemicals known to cause cancer, birth defects or other reproductive harm. Some examples of these chemicals are:

- Lead from lead-based paints,
- Crystalline silica from bricks and cement and other masonry products,
- Arsenic and chromium from chemically-treated lumber.

Your risk from these exposures varies, depending on how often you do this type of work. To reduce your exposure to these chemical: work in a well-ventilated area, and work with approved safety equipment, such as those dust masks that are specially designed to filter out microscopic particles.

## ENVIRONMENTAL PROTECTION



Waste electrical products should not be disposed of with household waste. Please recycle where facilities exist. Check with your local authority or retailer for recycling advice.

The battery contains material which is hazardous to you and the environment. It must be removed and disposed of separately at a facility that accepts lithium-ion batteries.

## SERVICE

Servicing requires extreme care and knowledge and should be performed only by a qualified service technician. For service we suggest you return the product to your nearest **AUTHORIZED SERVICE CENTER** for repair. When servicing, use only identical replacement parts.



**WARNING:** To avoid serious personal injury, do not attempt to use this product until you have read this Owner's Manual thoroughly and understand it completely. If you do not understand the warnings and instructions in this Owner's Manual, do not use this product. Call the Toll-free Helpline (1-800-791-9458) for assistance.



**WARNING:**









The operation of any power tool can result in foreign objects being thrown into your eyes, which can result in severe eye damage. Before beginning power tool operation, always wear safety goggles or safety glasses with side shields and, when needed, a full face shield. We recommend Wide Vision Safety Mask for use over eyeglasses or standard safety glasses with side shields. Always use eye protection which is marked to comply with ANSI Z87.1.





# SYMBOLS

Some of the following symbols may be used on this product. Please study them and learn their meaning. Proper interpretation of these symbols will allow you to operate the product better and safer.

SYMBOL	NAME	DESIGNATION/EXPLANATION
V	Volts	Voltage
A	Amperes	Current
Hz	Hertz	Frequency (cycles per second)
W	Watts	Power
min	Minutes	Time
	Safety Alert	Precautions that involve your safety.
	Read the user's manual	To reduce the risk of injury, user must read and understand user's manual before using this product.
	Eye protection	Wear eye protection that is marked to comply with ANSI Z87.1 when operating this equipment.
	Wet conditions alert	Do not expose to rain or use in damp locations.
	Long hair	Failure to keep long hair away from the air inlet could result in personal injury.
	Loose clothing	Failure to keep loose clothing from being drawn into air intake could result in personal injury.
	Keep Bystanders away	Keep all bystanders at least 50 ft. away.
	Blower tubes	Do not operate without tubes in place.
	Electric shock alert	Beware of electric shock hazard.

**SAVE THESE INSTRUCTIONS**

## KNOWING YOUR BLOWER

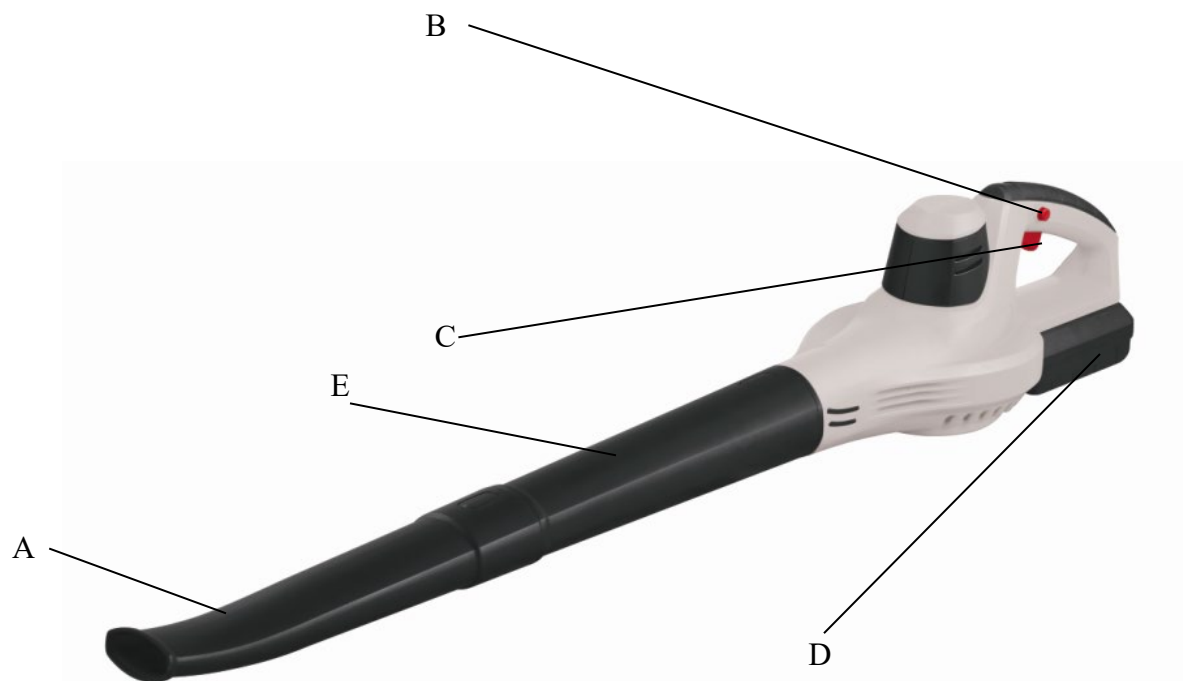

A Blower small tube  
C On/Off trigger switch  
E Blower big tube

B Lock off button  
D Battery pack

### **Unpacking**

Unpack the blower and all its parts, and compare against the list below. Do not discard the carton or any packaging materials. Please call 1-800-791-9458 or E-mail us at [support@amerisuninc.com](mailto:support@amerisuninc.com) if any parts are damaged or missing.

Including:

- Blower
- 20V Battery and Charger
- User manual
- Blower tube

# ASSEMBLY INSTRUCTIONS

## INSTALLING THE BLOWER TUBE

**CAUTION:** Always ensure that the tool is switched off and the battery is removed before making any adjustments or maintenance procedures.

- Slide the small tube (C) over the big tube (B) until the latch on the big tube is inserted into the end of the opening on the small tube and locks into position (see fig.1)
- Align the widest end of the big tube (B) with the front opening on the blower (A). (see fig 2)

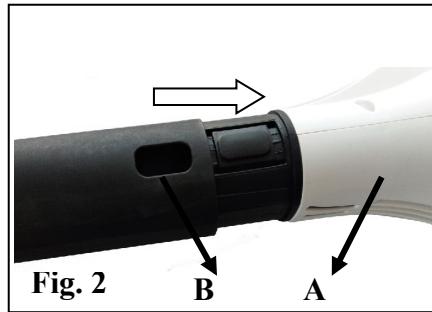
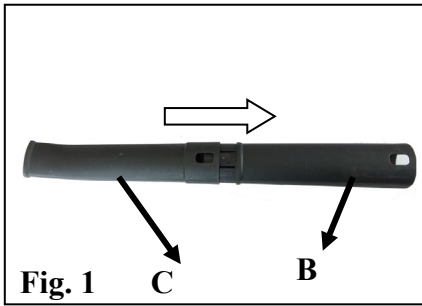

## CONNECTING AND REMOVING BATTERY

### IMPORTANT!

The battery pack is not charged when it is purchased. Before using the blower for the first time, place the battery pack in the battery charger and charge. Make sure to read all safety precautions, and follow the instructions in the battery charger section.

### To remove the battery pack

- Press the button (1) on the battery pack down and hold (see fig.3)
- Grasp the blower (2) firmly, and pull the battery pack out of the handle. (see fig 4)

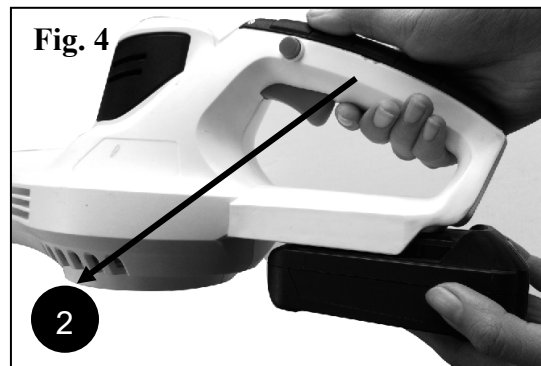
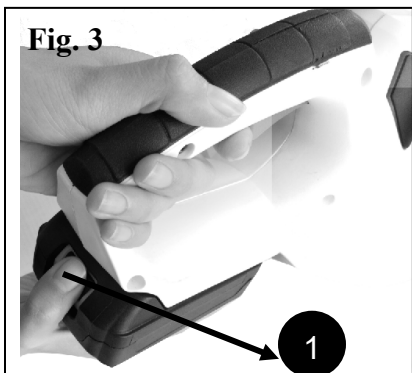

## To install the battery pack

To install the battery pack into the tool, align the rails of the battery pack with the rails in the tool and push the battery into the handle. To connect the battery, slide the battery pack fully forward. Until the latch locks into place.



### **WARNING:**

Follow these instructions in order to avoid injury and to reduce the risk of electric shock or fire:

- Replace the battery pack or the charger immediately if the battery case or charger cord is damaged.
- Verify that the battery pack is removed before inspecting, adjusting, or performing maintenance on any part of the blower.
- Read, understand, and follow the instructions.

## **OPERATING INSTRUCTIONS**



**WARNING:** Read and thoroughly understand all instructions and safety information before operating this blower. Failure to do so may cause serious injury or death. Do not allow anyone to operate this blower who has not read this manual. A blower can be dangerous if assembled or used improperly. Do not operate this blower if you have doubts or questions concerning safe operation. Call our customer service department at 1-800-791-9458 to address these concerns.

### **STARTING/STOPPING THE BLOWER (see fig.5)**

- Install the battery pack. (Refer to Installing the battery pack)
- To switch on squeeze the trigger switch (1)
- To switch off, release the trigger switch (1).



### **Use the blower to (see fig.6)**

- Blow debris or grass clippings off of driveways, sidewalks, patios, parks, parking lots, etc.
- Gather grass clippings, straw, or leaves into piles.
- Remove debris from corners, around joints, and between bricks.

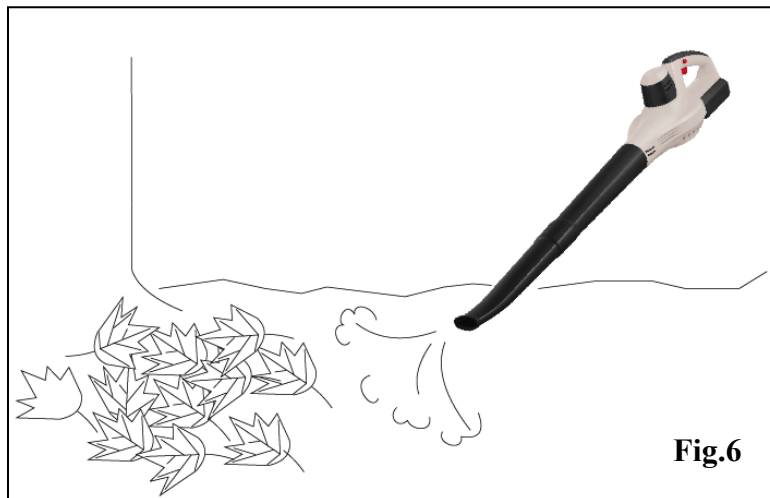

## **MAINTENANCE**



### **WARNING:**

In order to avoid personal injury and the risk of fire and electric shock, remove the battery pack before adjusting, inspecting, or cleaning the blower.

## **CLEANING**

Remove the battery pack.

- Brush or blow dust and debris out of the air vents using compressed air or a vacuum. Keep the air vents free of obstructions, sawdust, and wood chips. Do not spray, wash, or immerse the air vents in water.
- Wipe off the housing and the plastic components using a moist, soft cloth. Do not use strong solvents or detergents on the plastic housing or plastic components. Certain household cleaners may cause damage, and may cause a shock hazard.

## **BATTERY PACK**

- Store the battery pack fully charged.
- Once the charging light turns green, remove the battery from the charger and disconnect the charger from the outlet.
- Do not store the battery pack on the tool.
- After charging, the battery pack may be stored in the charger, as long as the charger is not plugged in.

## **CHARGER MAINTENANCE**

- Keep the charger clean and clear of debris. Do not allow foreign material to get into the recessed cavity or onto the contacts. Wipe the charger clean with a dry cloth. Do not use solvents or water, and do not place the charger in wet conditions.
- Unplug the charger when there is no battery pack in it.
- Fully charge the batteries before placing them in storage.
- Store the charger at normal room temperature. Do not store it in excessive heat. Do not use the charger in direct sunlight. Recharge at room temperature between 45°F and 104°F. If the battery pack is hot, allow it to cool down before recharging.

## ENVIRONMENTALLY SAFE BATTERY DISPOSAL

The batteries used in this blower's battery pack contain the following toxic and corrosive material:  
LITHIUM-ION.



### **WARNING:**

Toxic materials must be disposed of in a specified manner in order to prevent contamination of the environment. Before disposing of damaged or worn out Lithium-Ion battery packs, contact your local waste disposal agency for information and specific instructions. Take the batteries to a local recycling and/or disposal center that is certified for disposal.

If the battery pack cracks or breaks, whether it leaks or not, do not recharge it and do not use it. Dispose of it and replace it with a new battery pack. **DO NOT ATTEMPT TO REPAIR IT!**

Follow these instructions in order to avoid injury and the risk of fire, explosion, or electric shock, and to avoid damage to the environment:

- Cover the battery's terminals with heavy-duty adhesive tape.
- Do not attempt to remove or destroy any of the components of the battery pack.
- Do not attempt to open the battery pack.
- If a leak develops, the electrolytes that are released are corrosive and toxic. Do not get the solution in the eyes or on the skin, and do not swallow it.
- Do not place batteries in regular household trash.
- DO NOT incinerate batteries.
- DO NOT place batteries where they will become part of any waste landfill or municipal solid waste stream.
- Dispose of batteries at a certified recycling or disposal center.

## TROUBLE SHOOTING

The following form lists the common operating system with problem and solutions. Please read the form carefully and follow it.

PROBLEMS	POSSIBLE CAUSES	SOLUTION
Motor fails to start when Switch trigger is depressed.	Battery is not secure.	To secure the battery pack, make sure the latches on the top of the battery pack snap into place.
	Battery is not charged.	Charge the battery pack according to the Instruction included with your model.
Unit will not start	Defective power switch.	Return to place of purchase or return the unit to a repair center.
Unit will not blow	Blocked tube	Clear the blockage.

# EXPLODED VIEW & PARTS LIST

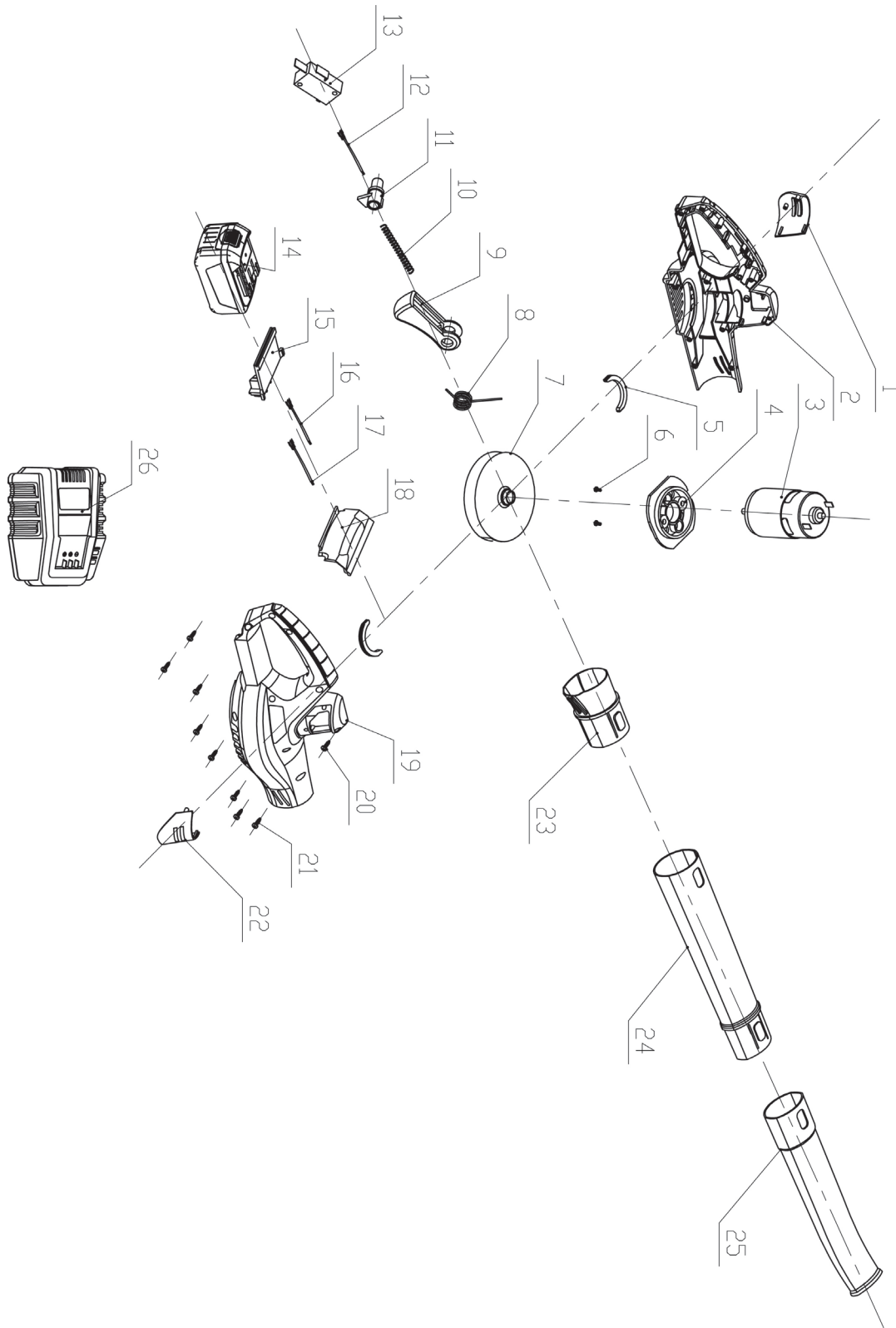

<b>Item</b>	<b>Stock#</b>	<b>Description</b>	<b>Qty</b>
1	PS76101A-001	Left front cover	1
2	PS76101A-002	Left housing	1
3	PS76101A-003	Motor	1
4	PS76101A-004	Motor retaining plate	1
5	PS76101A-005	Shock pad	4
6	PS76101A-006	Screw ST4x10	2
7	PS76101A-007	Fan	1
8	PS76101A-009	Button spring	1
9	PS76101A-010	Switch button	1
10	PS76101A-011	Un-locked button spring	1
11	PS76101A-012	Un-locked button	1
12	PS76101A-013	Lead wire	1
13	PS76101A-014	Switch	1
14	PS76101A-015	Battery	1
15	PS76101A-016	Battery connector	1
16	PS76101A-017	Lead wire	1
17	PS76101A-018	Lead wire	1
18	PS76101A-019	Wind scooper	1
19	PS76101A-020	Right housing	1
20	PS76101A-021	Screw ST3x12	1
21	PS76101A-022	Screw ST4x14	10
22	PS76101A-023	Right front cover	1
23	PS76101A-024	Connector tube	1
24	PS76101A-025	Tube1	1
25	PS76101A-026	Tube2	1
26	PS76101A-027	Charger	1



## **TWO (2) YEARS LIMITED WARRANTY**

PowerSmart® is committed to building tools that are dependable for years. Our warranties are consistent with our commitment and dedication to quality.

### **TWO (2) YEARS LIMITED WARRANTY OF POWER SMART PRODUCTS FOR HOME USE.**

PowerSmart ("Seller") warrants to the original purchaser only, that all PowerSmart consumer power tools will be free from defects in material or workmanship for a period of two (2) years from date of purchase. Ninety (90) days for all Power Smart Products, if the tool is used for professional or commercial use.

SELLER'S SOLE OBLIGATION AND YOUR EXCLUSIVE REMEDY under this Two (2) Years Limited Warranty and, to the extent permitted by law, any warranty or condition implied by law, shall be the repair or replacement of parts, without charge, which are defective in material or workmanship and which have not been misused, carelessly handled, or misrepaired by persons other than Seller or Authorized Service Center. To make a claim under this Limited Warranty, you must return the entire power tool product; transportation prepaid, to Power Smart Include a legible copy of the original receipt, which lists the date of purchase (month and year) and the name of the company purchased from.

THIS LIMITED WARRANTY DOES NOT APPLY TO ANY ACCESSORY ITEMS INCLUDED WITH THE TOOL SUCH AS CIRCULAR SAW BLADES OTHER RELATED ITEMS OR TO ANY REPLACEMENT PARTS LISTED UNDER MAINTENANCE.

ANY IMPLIED WARRANTIES SHALL BE LIMITED IN DURATION TO TWO (2) YEARS FROM DATE OF PURCHASE. SOME STATES IN THE U.S. AND SOME CANADIAN PROVINCES DO NOT ALLOW LIMITATIONS ON HOW LONG AN IMPLIED WARRANTY LASTS, SO THE ABOVE LIMITATION MAY NOT APPLY TO YOU.

IN NO EVENT SHALL SELLER BE LIABLE FOR ANY INCIDENTAL OR CONSEQUENTIAL DAMAGES (INCLUDING BUT NOT LIMITED TO LIABILITY FOR LOSS OF PROFITS) ARISING FROM THE SALE OR USE OF THIS PRODUCT. SOME STATES IN THE U.S. AND SOME CANADIAN PROVINCES DO NOT ALLOW THE EXCLUSION OR LIMITATION OF INCIDENTAL OR CONSEQUENTIAL DAMAGES, SO THE ABOVE LIMITATION OR EXCLUSION MAY NOT APPLY TO YOU.

THIS LIMITED WARRANTY GIVES YOU SPECIFIC LEGAL RIGHTS, AND YOU MAY ALSO HAVE OTHER RIGHTS WHICH VARY FROM STATE TO STATE IN THE U.S., PROVINCE TO PROVINCE IN CANADA AND FROM COUNTRY TO COUNTRY.

For questions / comments, technical assistance or repair parts –  
Please call toll free at: 1-800-791-9458 (M-F 9am – 5pm EST)  
Email: [support@amerisuninc.com](mailto:support@amerisuninc.com)

**SAVE YOUR RECEIPTS. THIS WARRANTY IS VOID WITHOUT THEM.**