

# POWER SMART<sup>®</sup>

## INSTRUCTION MANUAL

### 2850 PSI ELECTRIC PRESSURE WASHER

Model # PS2028

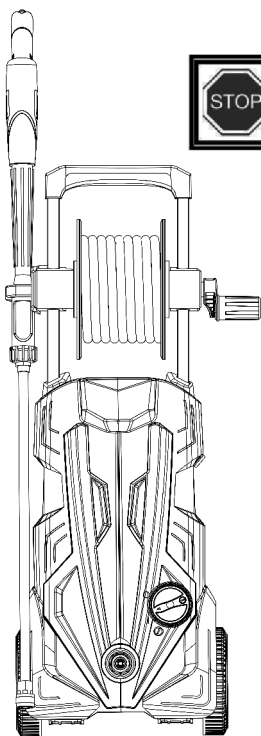

Have product questions or need technical support? Please scan the QR code to enter our official website and contact us!

Website: [www.powersmartusa.com](http://www.powersmartusa.com)

Toll free: 1-800-791-9458 M-F 9-5 EST

Email: [support@amerisuninc.com](mailto:support@amerisuninc.com)



Website



## **CONTENTS**

|  |    |
|--|----|
| Technical data .....                                   | 3  |
| Introduction .....                                     | 4  |
| Safety information .....                               | 4  |
| General safety rules.....                              | 5  |
| Special safety rules for electric pressure washer..... | 7  |
| Symbols .....  | 8  |
| Knowing your electric pressure washer.....             | 9  |
| Assembly instruction.....                              | 10 |
| Operating instruction.....                             | 11 |
| Maintenance.....                                       | 14 |
| Trouble shooting.....                                  | 15 |
| Exploded view.....                                     | 16 |
| Parts list.....  | 17 |
| Warranty statement.....                                | 19 |

## **TECHNICAL DATA**

|                                   |                        |
|-----------------------------------|------------------------|
| 2850 PSI Electric pressure washer | Model # PS2028         |
| Voltage:                          | AC120 V,60Hz           |
| Motor:                            | 14.5 Amp               |
| Max. pressure:                    | 2850 PSI               |
| Max. flow rate:                   | 1.85 GPM               |
| Max. Tap water:                   | 58Psi                  |
| Cord length:                      | 35 ft.                 |
| Water temperature:                | 32~104°F               |
| Working temperature:              | 41~122°F               |
| Package dimensions (L x W x H):   | 32.3x13.2 x12.2 inches |
| Weight:                           | 19.8 lb.               |

## **INTRODUCTION**

Thank You for Purchasing a PowerSmart® Product. This manual provides information regarding the safe operation and maintenance of this product. Every effort has been made to ensure the accuracy of the information in this manual. PowerSmart® reserves the right to change this product and specifications at any time without prior notice.

Please keep this manual available to all users during the entire life of the electric pressure washer.



This manual contains special messages to bring attention to potential safety concerns, electric pressure washer damage as well as helpful operating and servicing information. Please read all the information carefully to avoid injury and machine damage.

### **QUESTIONS? PROBLEMS?**

Please contact our Customer Service Dept. with any questions and/or comments, either by Email: support@amerisuninc.com, or Toll Free at (800)791-9458. We are available Mon-Fri 9am-5pm EST to help solve any issues that you might encounter.

## **SAFETY INFORMATION**

Before operating this electric pressure washer, read and observe all warnings, cautions, and instructions on the electric pressure washer and in this Owner's Manual.

**NOTE:** The following safety information is not meant to cover all possible conditions and situations that may occur. Read the entire Owner's Manual for safety and operating instructions. Failure to follow instructions and safety information could result in serious injury or death.

This safety alert symbol is used to identify safety information about hazards that can result in personal injury.



A signal word (**DANGER**, **WARNING**, or **CAUTION**) is used with the alert symbol to indicate the likelihood and the potential severity of injury. In addition, a hazard symbol may be used to represent the type of hazard.

**DANGER** Indicates a hazard, which, if not avoided, will result in death or serious injury.

**WARNING** Indicates a hazard, which, if not avoided, could result in death or serious injury.

**CAUTION** Indicates a hazard, which, if not avoided, might result in minor or moderate injury.

**CAUTION** Without the alert symbol, indicates a situation that could result in damage.

## **GENERAL SAFETY RULES**

Safety is a combination of common sense, staying alert, and knowing how your electric pressure washer works.

### **SAVE THESE SAFETY INSTRUCTIONS.**



**WARNING:** Do not operate this unit until you read this instruction manual for safety, operation and maintenance instructions. Failure to follow all instructions listed below may result in electric shock, fire, and/or serious personal injury.

### **WORK AREA SAFETY**

- This appliance is not intended for use by children or by unassisted, unsupervised persons whose physical, sensory or mental capabilities prevent them from using it safely. Children should be supervised to ensure that they do not play with the appliance.
- Keep bystanders away . All visitors and pets should be kept a safe distance away from the work area.
- Never use the machine in potentially explosive areas under any circumstances.
- The operator must use the appliance correctly. When working with the appliance, he must consider the local conditions and pay due care and attention to other persons, in particular children who are nearby.
- This electric pressure washer is designed for domestic use only:
  1. To clean cars, motorbikes, caravans, bicycles.
  2. To clean patios, fences, garden walls, pathways, driveways and house facades, particularly useful for cleaning blocked driveway.
  3. To remove of algae and moss from roofs, brickwork and guttering.
  4. To clean garden tools and machinery, furniture and barbecues.
  5. To clean hygienic of animal pens and their surrounding area.

### **ELECTRICAL SATETY**

#### **Grounding instructions**

IN THE EVENT OF A MALFUNCTION OR BREAKDOWN, grounding provides the path of least resistance for electric current and reduces the risk of electric shock. This tool is equipped with an electric cord that has an equipment grounding conductor and a grounding plug. The plug **MUST** be plugged into a matching outlet that is properly installed and grounded in accordance with ALL local codes and ordinances.

**DO NOT MODIFY THE PLUG PROVIDED.** If it will not fit the outlet, have the proper outlet installed by a licensed electrician.

**IMPROPER CONNECTION** of the equipment grounding conductor can result in electric shock. The conductor with the green insulation (with or without yellow stripes) is the equipment grounding conductor. If repair or replacement of the electric cord or plug is necessary, **DO NOT** connect the equipment grounding conductor to a live terminal.

**CHECK** with licensed electrician or service personnel if you do not completely understand the grounding instructions, or if you are not sure if the tool is properly grounded.

USE ONLY THREE-WIRE EXTENSION CORDS that have 3-pronged plugs and outlets that accept the tool's plug as shown in Fig. A. Repair or replace a damaged or worn cord immediately.



**CAUTION:** In all cases, make certain the outlet in question is properly grounded. If you are not sure if it is, have a licensed electrician check the outlet.



**WARNING:** Do not expose to rain or use in damp locations.

### Guidelines for using extension cords

Make sure your extension cord is in good condition. When using an extension cord, be sure to use one heavy enough to carry the current your product will draw. An undersized cord will cause a drop in line voltage resulting in loss of power and overheating. The table below shows the correct size to be used according to cord length and nameplate ampere rating. If in doubt, use the next heavier gauge. The smaller the gauge number, the heavier the cord.

**Minimum Gauge for Extension Cords (AWG)**  
 (When using 120 V only)

| Ampere Rating |               | Total Length of Cord in feet |    |                 |     |
|---------------|---------------|------------------------------|----|-----------------|-----|
| More Than     | Not More Than | 25                           | 50 | 100             | 150 |
| 0             | 6             | 18                           | 16 | 16              | 14  |
| 6             | 10            | 18                           | 16 | 14              | 12  |
| 10            | 12            | 16                           | 16 | 14              | 12  |
| 12            | 16            | 14                           | 12 | Not Recommended |     |

Make sure your extension cord is properly wired and in good condition. Always replace a damaged extension cord or have it repaired by a qualified person before using it.

Protect your extension cords from sharp objects, excessive heat and damp or wet areas.

Use a separate electrical circuit for your tools. This circuit must not be less than a #12 wire and should be protected with a 15 A time-delayed fuse. Before connecting the motor to the power line, make sure the switch is in the OFF position and the electric current is rated the same as the current stamped on the motor nameplate. Running at a lower voltage will damage the motor.



**WARNING:** This tool must be grounded while in use to protect the operator from electric shock.

## **PERSONAL SAFETY**

- The electric pressure washer may not be directed at persons, animals, live electrical equipment or at the appliance itself.
- Keep bystanders away . All visitors and pets should be kept a safe distance away from the work area.
- Do not wear loose clothing or jewelry. They can get caught in moving parts. Protective rubber gloves and non-slip footwear are recommended when working outdoors.
- Watch what you are doing. Use common sense. Do not operate the pressure washer when you are tired, or under the influence of alcohol or drugs.
- Do not overreach. Keep proper footing and balance at all times.
- Avoid unintentional starting. Do not carry a plugged-in machine with your finger on the trigger. Make sure the switch is off before plugging in the machine.
- Do not abuse the cord . Never carry the machine by the cord or yank the cord to disconnect it from the receptacle. Keep the cord away from heat, oil, and sharp edges.
- Use safety glasses . Also use safety footwear, snug-fitting clothing, protective gloves, hearing and head protection.

## **SERVICE**

- Tool service must be performed only by qualified repair personnel. Service or maintenance performed by unqualified personnel could result in a risk of injury.
- When servicing a tool, use only identical replacement parts. Follow instructions in the Maintenance section of this manual. Use of unauthorized parts or failure to follow Maintenance Instructions may create a risk of electric shock or injury.









## **SPECIFIC SAFETY RULES FOR ELECTRIC PRESSURE WASHER**

- Do not point the gun at anyone or at any part of the body.
- Before servicing, cleaning, or removing any parts, shut off the power and relieve pressure.
- Check the water temperature . This pressure washer is not meant to pump hot water. NEVER connect it to a hot water supply as it will significantly reduce the life of the pump.
- Store indoors. NEVER store the pressure washer outdoors or where it could freeze. The pump could be seriously damaged.
- Risk of explosion. Do not spray flammable liquids. Never draw in fluids containing solvents or undiluted acids. This includes petrol, paint thinner and heating oil. The spray mist thus generated is highly inflammable, explosive and poisonous. Do not use acetone, undiluted acids or solvents as they are damaging to the materials from which is the appliance is made.
- High pressure hoses, fixtures and couplings are important for the safety of the appliance. Only use high pressure hoses, fixtures and couplings recommended by the manufacturer.
- Create stability for the appliance prior to all work on or with the appliance to prevent accidents or damage. The stability of the appliance is warranted when it is placed on to an even surface.
- Never leave the appliance unattended when it is in operation.
- The appliance must not be used if the power cord or important parts of the appliance, e.g. high pressure hoses, trigger gun or safety devices are damaged. Please arrange for it to be replaced immediately by an authorised repair agent or a skilled electrician.
- The electric pressure washer must not be directed at other persons or directed by the user at him/herself to clean clothing or footwear.
- If the appliance is used in hazardous areas (e.g. filling stations) all of the safety provisions and operating instructions detailed in this manual must be observed.
- Never use the appliance to clean objects containing hazardous substances.

- Vehicle tyres or tyre valves are susceptible to damage from the electric pressure washer and may burst. The first indication of this is a discoloration of the tyre. Damaged vehicle tyres/tyre valves are highly dangerous. Ensure that a distance of at least 30 cm is observed when cleaning with the washer.
- Risk of explosion. Do not spray flammable liquids. Never draw in fluids containing solvents or undiluted acids. This includes petrol, paint thinner and heating oil. The spray mist thus generated is highly inflammable, explosive and poisonous. Do not use acetone, undiluted acids or solvents as they are damaging to the materials from which the appliance is made.
- Always fully unroll electrical cables.
- Do not cover or modify the spray wand or the spray nozzle in any way.
- Do not use the machine if the persons nearby do not wear safety protection device.
- Wearing protective clothing and safety goggles to protect against splash back containing water or dirt.

## **SYMBOLS**

Some of the following symbols may be used on this product. Please study them and learn their meaning. Proper interpretation of these symbols will allow you to operate the product better and safer.

| SYMBOL   | NAME                   | DESIGNATION/EXPLANATION  |
|--|------------------------|--|
| V  | Volts                  | Voltage  |
| A  | Amperes                | Current  |
| Hz   | Hertz                  | Frequency (cycles per second)  |
| W  | Watts                  | Power  |
| MIN  | Minutes                | Time   |
|    | Safety Alert           | Precautions that involve your safety.  |
|    | Read the user's manual | To reduce the risk of injury, user must read and understand user's manual before using this product. |
|    | Eye protection         | Wear eye protection when operating this equipment.   |
|    | Hearing protection     | Use proper hearing protection when operating this equipment.   |
|  | Wear non-slip footwear | Wear non-slip footwear that will protect your feet and improve your footing on slippery surfaces.    |
|  | Keep bystanders away   | To reduce the risk of injury, user must keep all bystanders at least 49 ft (15 m) away.              |
|  | Wet conditions alert   | Do not expose to rain or use in damp locations.  |
|  | Electric shock alert   | Beware of electric shock hazard.   |



# KNOWING YOUR ELECTRIC PRESSURE WASHER

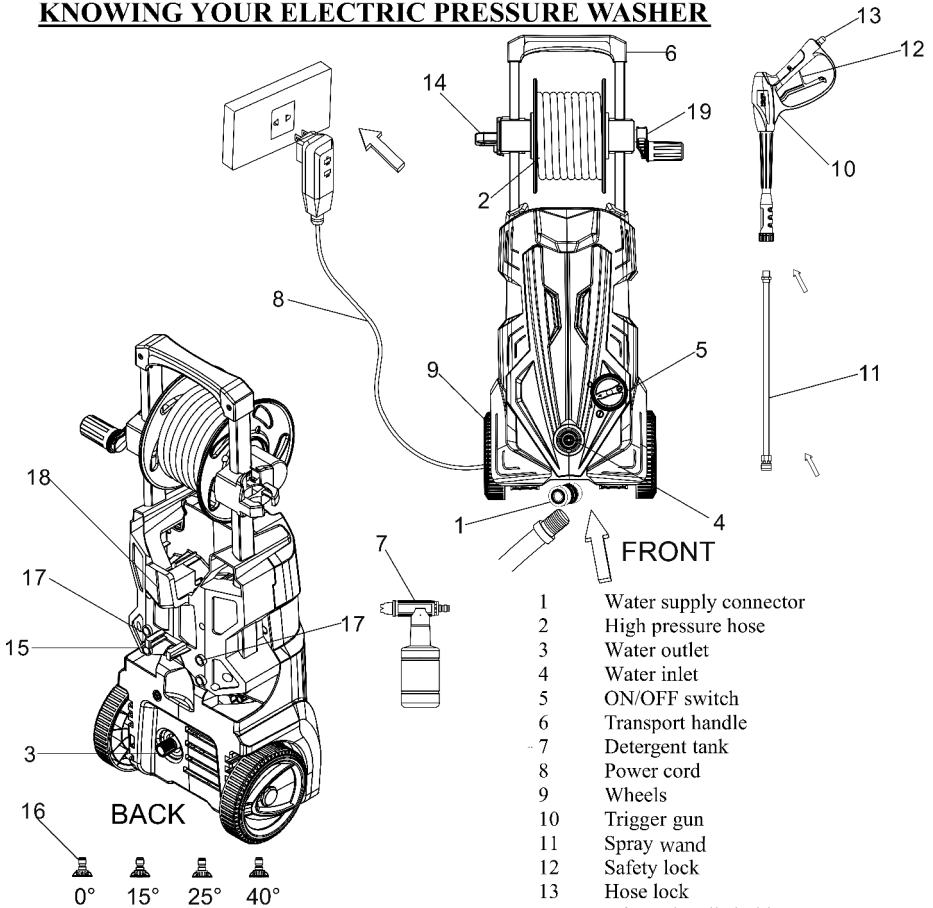

Fig.1

## Unpacking

Unpack the power tool and all its parts, and compare against the list below. Do not discard the carton or any packaging materials. Please call 1-800-791-9458 or E-mail us at [support@amerisuninc.com](mailto:support@amerisuninc.com) if any parts are damaged or missing.

Including: Electric pressure washer/ Trigger gun / Spray lance / Four Quick-Connect nozzles / Detergent tank / Needle/ User manual

## ASSEMBLY INSTRUCTION



### **WARNING:**

Do not use this product if any parts on the packing list are already assembled to your product when you unpack it. Parts on this list are not assembled to the product by the manufacturer and require customer installation. Use of a product that may have been improperly assembled could result in serious personal injury.



### **WARNING:**

If any parts are damaged or missing do not operate this product until the parts are replaced. Use of this product with damaged or missing parts could result in serious personal injury.



### **WARNING:**

Do not attempt to modify this product or create accessories not recommended for use with this product. Any such alteration or modification is misuse and could result in a hazardous condition leading to possible serious personal injury.



### **WARNING:**

Do not connect to power supply until assembly is complete. Failure to comply could result in accidental starting and possible serious personal injury.

1. Install coupling for water supply connector (Fig.2). Screw the coupling to the water inlet on the appliance.
2. Install high pressure hose (Fig.3)  
Insert the high pressure hose tightly in to coupling on the appliance/trigger gun and screw to the end. (Fig.4)
3. Install spray wand (Fig.5). Push the spray wand into the trigger gun and screw to the end.
4. Install the handle crank (Fig.6). Push the handle crank and twist the screw to the end.

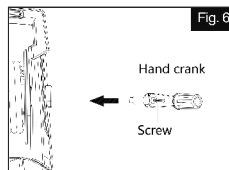
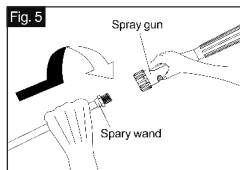
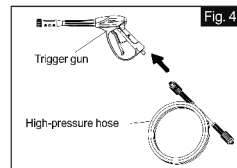
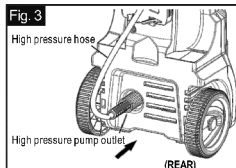
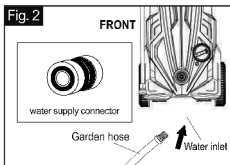

## OPERATING INSTRUCTION



**WARNING:** Prior to cleaning, make sure that the electric pressure washer is placed safely on level ground. Wear protective goggles and protective clothing during the cleaning process. **Notes:** Release the lever of the trigger gun, the device will switch off again. Electric pressure washer remains in the system.

## USING THE PRESSURE WASHER



**WARNING:** Impurities in the water can damage the high pressure pump and accessories. All electric pressure washer (except hot water system) use the cold water. The suitable water temperature is 0°C to 40°C.

- Position the washer as CLOSE as possible to the water supply.
- The washer must be used on a secure and stable surface in a standing, upright position (Fig.7).

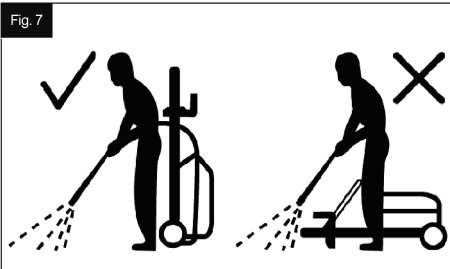

- Make sure the unit is switched off before plugging the unit into the power outlet.
- Check that the electrical supply voltage and frequency (Volt/Hz) correspond to those specified on the rating plate. If the power supply is correct, you may now plug the pressure washer into the power outlet.

**NOTE:** The GFCI may need to be reset when first plugged into the electric outlet. Press the "Reset" button until the power light indicator on the GFCI illuminates when plugged in (Fig. 8).

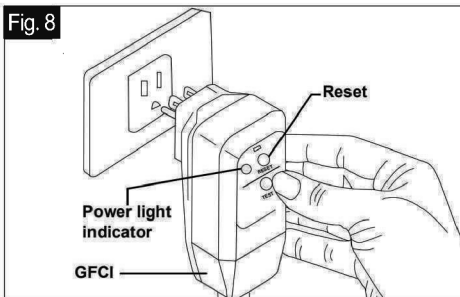

- Turn the water supply tap on completely.

- Make sure the safety lock is down and in its original position (Fig.9) , then press the trigger for a few seconds until water flow is steady. This will allow air to escape and discharge any residual pressure in the hose.

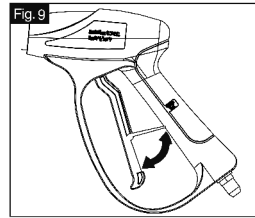

- Turn the ON/OFF switch to the ON position to start the pressure washer(Fig.10) .

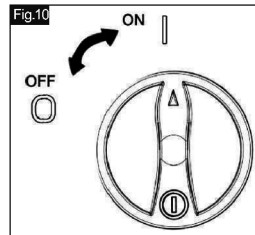

- When re-starting the motor, always keep the trigger pressed.  
**NOTE:** The motor only runs when the trigger is operated and shuts off when the trigger is released.

## USING NOZZLES

Before beginning any cleaning task, determine the best nozzle for the job. Each of the nozzles has a different spray pattern.

This electric pressure washer is equipped with four(4) Quick-Connect nozzles that easily snap onto the Quick-Connect collar of the spray wand. The nozzle patterns are 40° (for gentle cleaning), 25° (for all-purpose cleaning), 15° (for tough jobs), 0° (for spot cleaning or hard-to-reach areas).

**CAUTION:** NEVER change nozzles without locking the safety lock on the trigger handle.



**WARNING:** High-pressure jets can be dangerous if subject to misuse. The jet must not be directed at persons, pets, live electrical equipment, or the appliance itself.

### To connect a nozzle to the spray wand

- Turn off the pressure washer and shut off the water supply. Pull the trigger to release water pressure.
- Engage the safety lock on the trigger handle .
- Snap the desired nozzle onto the Quick-Connect collar until it clicks into place (Fig. 11).

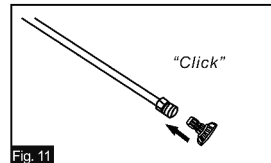

## To disconnect a nozzle from the spray wand

- Turn off the pressure washer and shut off the water supply. Pull the trigger to release water pressure.
- Engage the safety lock on the trigger handle .
- Remove the nozzle by placing your hand over the nozzle while pulling back on the Quick-Connect collar.
- The nozzles can be stored on the back of the machine(Fig.12).

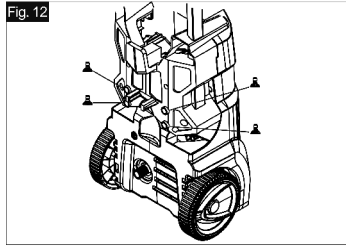

**WARNING:** Do not make changes to the nozzle while the trigger is engaged. Doing so could result in damage to the pressure washer or injury to the user.

## WORKING WITH DETERGENT



**WARNING:** Use only detergents specifically designed for use with pressure washers.

**DO NOT USE** household detergents, acids, alkaline solutions, bleaches, solvents, flammable material, or industrial grade solutions. These could damage the pressure washer. Many detergents may require mixing prior to use. Prepare the cleaning solution as instructed on the solution bottle.

- Remove the head with suction tube by unscrewing it. (Fig.13).
- Fill the tank or mix as recommended by detergent instructions, and secure the head back into place.
- Install the detergent tank on the spray wand.
- Turn on the pressure washer. Pull the trigger to operate the unit.
- When finished using the pressure washer, you must first drain and rinse the detergent tank. Run the pressure washer until all of the soap is drained from the detergent tank.

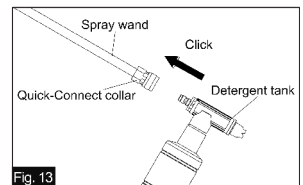

## FINISH OPERATION

1. Turn off the water source.
2. Press the lever on the trigger gun to release any remaining pressure and water in the system.
3. Turn the switch to the OFF position and unplug the power cord from the outlet.
4. Disconnect the high-pressure hose connection on the trigger gun handle.
5. Store the water hose and high pressure hose.

## MAINTENANCE



**WARNING:** In order to avoid personal injury and the risk of fire and electric shock, turn off the appliance and remove the mains plug prior to any care and maintenance work.



**WARNING:** When servicing, use only identical replacement parts. Use of any other parts could create a hazard or cause product damage.

## CLEANING

- Pull out the filter in the water connection and clean under running water. (Fig. 14).
- Pull out the nozzle and use the needle to clean.(Fig.15).

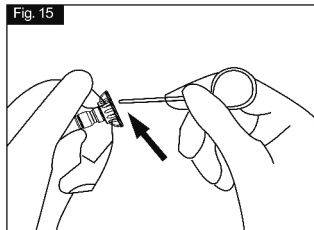
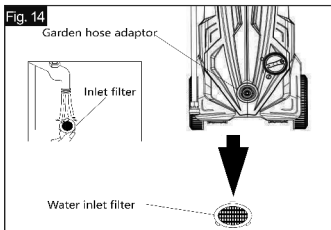

## STORAGE

- Place the appliance on a level ground.
- Disconnect trigger gun and high pressure hose.
- Disconnect high pressure hose with outlet.
- Put the trigger gun into the trigger gun holder.
- Wind back power cord and high pressure.
- In winter, please do not put the machine outside without draining the water to avoid the damage to the machine. Just put it in a room with frost prevention.

## SCHEMATIC DRAWING

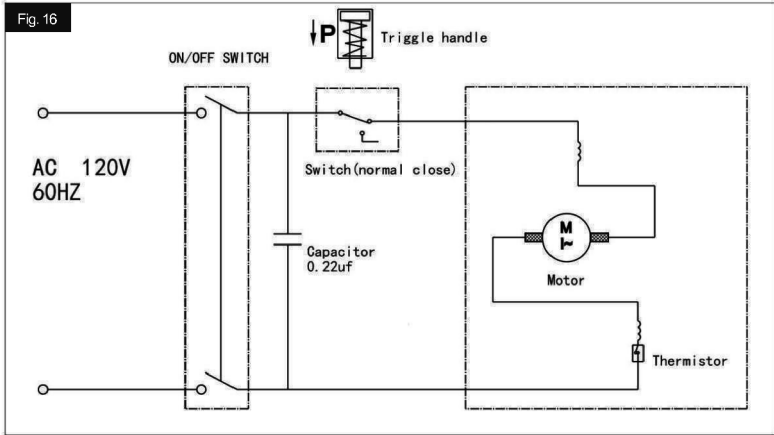

## TROUBLE SHOOTING



**WARNING:** Read instruction manual first! Remove plug from power source before making adjustments or assembling accessories.

| Problem                                     | Possible Cause   | Possible Solution   |
|---|--|---|
| Appliance is not running                    | <ol style="list-style-type: none"> <li>1.Machine not plugged in</li> <li>2.Defective socket</li> <li>3.Defective extension cable</li> <li>4.Incorrect mains voltage</li> <li>5.Switch off</li> <li>6.Fuse has blown</li> </ol> | <ol style="list-style-type: none"> <li>1.Plug in machine</li> <li>2.Try another socket</li> <li>3.Try another extension cable</li> <li>4.Check voltage correctly</li> <li>5.Turn on switch</li> <li>6.Replace fuse</li> </ol> |
| Pump stop working                           | Lack of water lead to high temperature   | Check water flow quantity   |
| Fluctuating pressure                        | <ol style="list-style-type: none"> <li>1.Spray lance blocked</li> <li>2.Pump is sucking air</li> <li>3.Impurities in pump</li> </ol>   | <ol style="list-style-type: none"> <li>1.Clean lance with needle</li> <li>2.Check that hoses and connections are airtight</li> <li>3.Contact the dealer</li> </ol>  |
| Appliance does not reach operation pressure | <ol style="list-style-type: none"> <li>1.Spray lance blocked or worn</li> <li>2.Short supply of water</li> <li>3.Hose kinked</li> <li>4.Filter blocked</li> <li>5.Hose blocked</li> </ol>                                      | <ol style="list-style-type: none"> <li>1.Clean or change spray lance</li> <li>2.Check inlet flow rate</li> <li>3.Straighten out hose</li> <li>4.Clean filter</li> <li>5.Clean hose</li> </ol>                                 |
| Trigger gun can be used                     | Trigger gun is locked  | Unlock trigger gun safety   |
| Machine often starts and stops by itself    | <ol style="list-style-type: none"> <li>1.Safety valve worn out</li> <li>2.Pump,high pressure hose, trigger gun is leaking</li> </ol>   | Call 800-791-9458   |

# EXPLODED VIEW

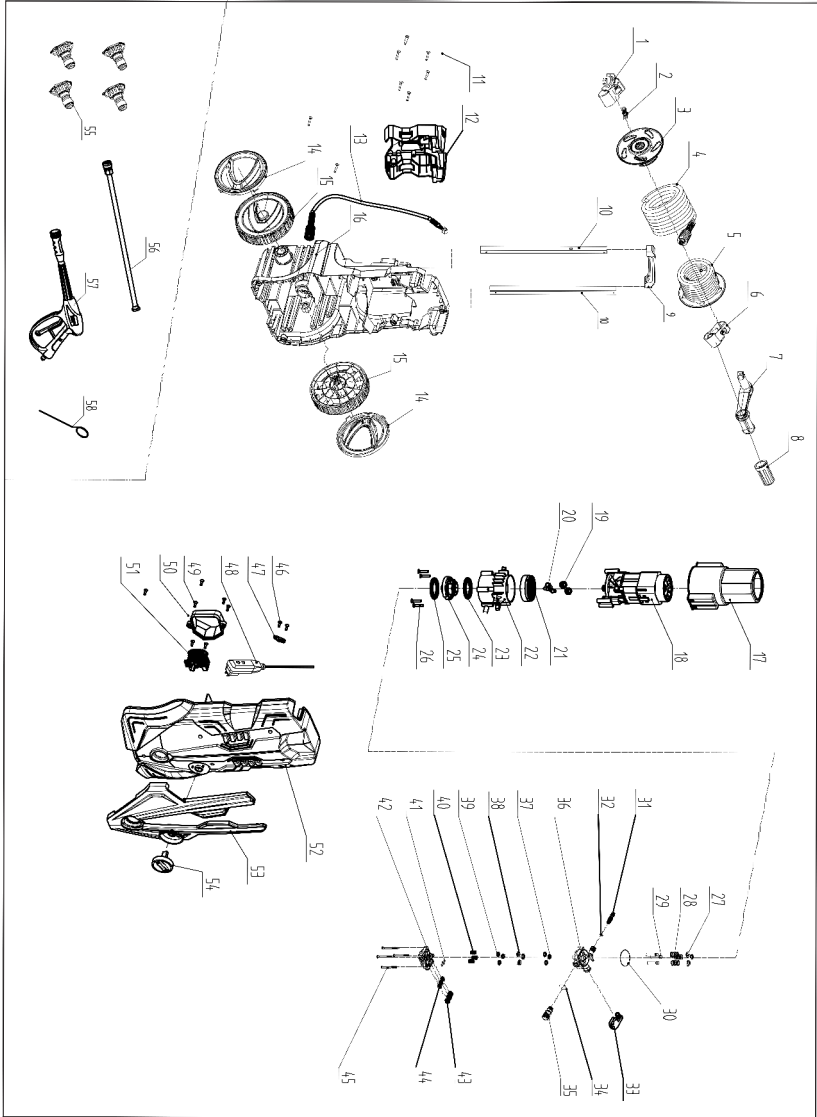



## **PARTS LIST**

| Number | Stock#     | Description                                  | QTY. |
|--------|------------|--|------|
| 1      | PS2028-001 | METAL HANDLE LEFT FIXING BLOCK (FOR GUN)     | 1    |
| 2      | PS2028-002 | BRASS CONNECTOR                              | 1    |
| 3      | PS2028-003 | LEFT HOSE REEL                               | 1    |
| 4      | PS2028-004 | HIGH PRESSURE HOSE L.=8000                   | 1    |
| 5      | PS2028-005 | RIGHT HOSE REEL                              | 1    |
| 6      | PS2028-006 | METAL HANDLE RIGHT FIXING BLOCK (FOR HANDLE) | 1    |
| 7      | PS2028-007 | HANDLE FOR HOSE REEL                         | 1    |
| 8      | PS2028-008 | HANDLE KNOB FOR HOSE REEL                    | 1    |
| 9      | PS2028-009 | METAL HANDLE SEAT                            | 1    |
| 10     | PS2028-010 | EXTRUSION PROFILES FOR HANDLE                | 2    |
| 11     | PS2028-011 | SCREW 3,9x22                                 | 17   |
| 12     | PS2028-012 | METAL HANDLE BRACKET                         | 1    |
| 13     | PS2028-013 | HIGH PRESSURE HOSE L=750                     | 1    |
| 14     | PS2028-014 | WHEEL COVER                                  | 2    |
| 15     | PS2028-015 | WHEEL  | 2    |
| 16     | PS2028-016 | BACK CABINET                                 | 1    |
| 17     | PS2028-017 | MOTOR CONVEYOR                               | 1    |
| 18     | PS2028-018 | MOTOR  | 1    |
| 19     | PS2028-019 | GEAR Z22                                     | 2    |
| 20     | PS2028-020 | PLANET SUPPORT                               | 1    |
| 21     | PS2028-021 | OUTSIDE GEAR Z56                             | 1    |
| 22     | PS2028-022 | ALUMINUM FLANGE                              | 1    |
| 23     | PS2028-023 | THRUST BEARING 45x62x11                      | 1    |
| 24     | PS2028-024 | WOBBLE PLATE 8.2°                            | 1    |
| 25     | PS2028-025 | THRUST BEARING 35X55X12                      | 1    |
| 26     | PS2028-026 | SCREW 5.5*25                                 | 4    |
| 27     | PS2028-027 | RETAINING RING D.21                          | 3    |
| 28     | PS2028-028 | PISTON SPRING                                | 3    |
| 29     | PS2028-029 | PISTON                                       | 3    |
| 30     | PS2028-030 | O-RING 62X2.1                                | 1    |
| 31     | PS2028-031 | CHECK VALVE ASSEMBLY                         | 1    |
| 32     | PS2028-032 | RING X VALVE GUIDE                           | 1    |
| 33     | PS2028-033 | BODY GUIDE                                   | 1    |
| 34     | PS2028-034 | TOTAL STOP SWITCH                            | 1    |
| 35     | PS2028-035 | INLET PIN                                    | 1    |
| 36     | PS2028-036 | INLET PLASTIC JOINT                          | 1    |
| 37     | PS2028-037 | OIL SEAL                                     | 3    |

|    |            |                          |   |
|----|------------|--------------------------|---|
| 38 | PS2028-038 | RING FOR SUPPORT SEAL    | 3 |
| 39 | PS2028-039 | WATER SEAL               | 3 |
| 40 | PS2028-040 | SUCTION VALVE            | 3 |
| 41 | PS2028-041 | SEAL GASKET              | 1 |
| 42 | PS2028-042 | PARTNER HEAD             | 1 |
| 43 | PS2028-043 | DELIVERY VALV.CAP        | 3 |
| 44 | PS2028-044 | DELIVERY VALVES          | 3 |
| 45 | PS2028-045 | SCREW M6*60              | 4 |
| 46 | PS2028-046 | SCREW 3,9x22             | 2 |
| 47 | PS2028-047 | FIX PAD                  | 1 |
| 48 | PS2028-048 | USA PLUG                 | 1 |
| 49 | PS2028-049 | SCREW 3,9x22             | 2 |
| 50 | PS2028-050 | COVER FOR ELECTRICAL BOX | 1 |
| 51 | PS2028-051 | ROTARY SWITCH            | 1 |
| 52 | PS2028-052 | FRONT CABINET            | 1 |
| 53 | PS2028-053 | FRONT PAD                | 1 |
| 54 | PS2028-054 | SWITCH KNOB              | 1 |
| 55 | PS2028-055 | NOZZLE KIT               | 1 |
| 56 | PS2028-056 | LANCE                    | 1 |
| 57 | PS2028-057 | GUN                      | 1 |
| 58 | PS2028-058 | PIN FOR NOOZLE           | 1 |

## **TWO (2) YEARS LIMITED WARRANTY**

PowerSmart® is committed to building tools that are dependable for years. Our warranties are consistent with our commitment and dedication to quality.

### **TWO (2) YEARS LIMITED WARRANTY OF POWERSMART PRODUCTS FOR HOME USE.**

PowerSmart ("Seller") warrants to the original purchaser only, that all PowerSmart consumer power tools will be free from defects in material or workmanship for a period of two (2) years from date of purchase. Ninety (90) days for all PowerSmart Products, if the tool is used for professional or commercial use.

SELLER'S SOLE OBLIGATION AND YOUR EXCLUSIVE REMEDY under this Two (2) Years Limited Warranty and, to the extent permitted by law, any warranty or condition implied by law, shall be the repair or replacement of parts, without charge, which are defective in material or workmanship and which have not been misused, carelessly handled, or misrepaired by persons other than Seller or Authorized Service Center. To make a claim under this Limited Warranty, you must return the entire power tool product; transportation prepaid, to PowerSmart Include a legible copy of the original receipt, which lists the date of purchase (month and year) and the name of the company purchased from.

THIS LIMITED WARRANTY DOES NOT APPLY TO ANY ACCESSORY ITEMS INCLUDED WITH THE TOOL SUCH AS CIRCULAR SAW BLADES OTHER RELATED ITEMS OR TO ANY REPLACEMENT PARTS LISTED UNDER MAINTENANCE.

ANY IMPLIED WARRANTIES SHALL BE LIMITED IN DURATION TO TWO (2) YEARS FROM DATE OF PURCHASE. SOME STATES IN THE U.S. AND SOME CANADIAN PROVINCES DO NOT ALLOW LIMITATIONS ON HOW LONG AN IMPLIED WARRANTY LASTS, SO THE ABOVE LIMITATION MAY NOT APPLY TO YOU.

IN NO EVENT SHALL SELLER BE LIABLE FOR ANY INCIDENTAL OR CONSEQUENTIAL DAMAGES (INCLUDING BUT NOT LIMITED TO LIABILITY FOR LOSS OF PROFITS) ARISING FROM THE SALE OR USE OF THIS PRODUCT. SOME STATES IN THE U.S. AND SOME CANADIAN PROVINCES DO NOT ALLOW THE EXCLUSION OR LIMITATION OF INCIDENTAL OR CONSEQUENTIAL DAMAGES, SO THE ABOVE LIMITATION OR EXCLUSION MAY NOT APPLY TO YOU.

THIS LIMITED WARRANTY GIVES YOU SPECIFIC LEGAL RIGHTS, AND YOU MAY ALSO HAVE OTHER RIGHTS WHICH VARY FROM STATE TO STATE IN THE U.S., PROVINCE TO PROVINCE IN CANADA AND FROM COUNTRY TO COUNTRY.

For questions / comments, technical assistance or repair parts –  
Please call toll free at: 1-800-791-9458 (M-F 9am – 5pm EST)  
Email: [support@amerisuninc.com](mailto:support@amerisuninc.com)

**SAVE YOUR RECEIPTS. THIS WARRANTY IS VOID WITHOUT THEM.**