

POWERSMART[®]

INSTRUCTION MANUAL

1500W Inverter Generator

Model # PS55

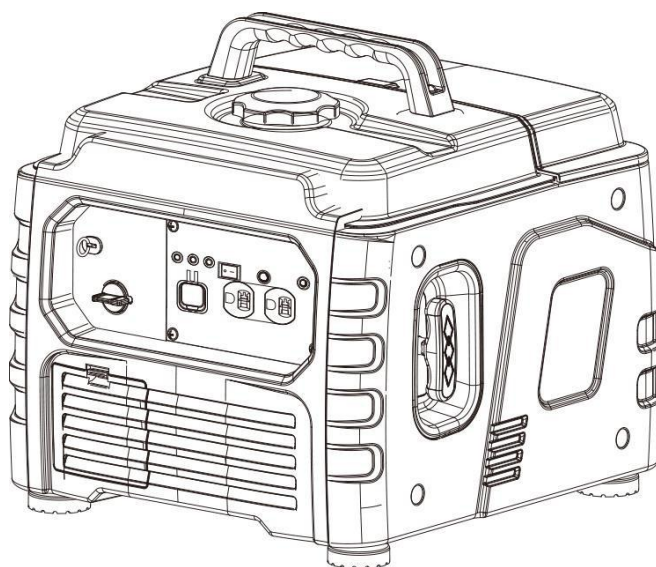

Have product questions or need technical support? Please scan the QR code to enter our official website and contact us!

Website: www.powersmartusa.com

Toll free: 1-800-791-9458 M-F 9-5 EST

Email: support@amerisuninc.com



Website

CONTENTS

Technical data.....	3
Introduction.....	4
Safety information.....	4
General safety rules	5
Important safety instructions.....	6
Symbols.....	7
Knowing your generator.....	8
Generator preparation.....	11
Starting the generator.....	15
Using the generator.....	16
Stopping the generator.....	17
Maintenance.....	17
Storage & transport procedures.....	21
Troubleshooting.....	22
Wiring diagram.....	23
Exploded view & parts list.....	24
Warranty statement.....	28

TECHNICAL DATA

1500W Inverter Generator	Model#PS55
Engine type:	4 stroke, OHV, single cylinder with forced air-cooling system
Start type:	Manual
Phase:	Single
Rated wattage:	1000 W
Starting wattage:	1500 W
Rated voltage:	120 V
Rated current:	8.3 A
Rated frequency:	60 Hz
Displacement:	56 cc
Continue Running Time:	4 hours
Spark plug gap:	0.6-0.8 mm (0.024-0.031 in.)
Fuel tank capacity:	0.74 Gallon
Engine Oil capacity:	9.47 Fl.oz
USB output voltage:	5V
Package dimensions(L x W x H):	13.2x12.9x12 inches
Weight:	26.5 lbs

INTRODUCTION

Thank You for Purchasing a PowerSmart® Product. This manual provides information regarding the safe operation and maintenance of this product. Every effort has been made to ensure the accuracy of the information in this manual. PowerSmart® reserves the right to change this product and specifications at any time without prior notice.



Please keep this manual available to all users during the entire life of the generator. This manual contains special messages to bring attention to potential safety concerns, generator damage as well as helpful operating and servicing information. Please read all the information carefully to avoid injury and machine damage.

QUESTIONS? PROBLEMS?

Please contact our Customer Service Dept. with any questions and/or comments, either by Email: support@amerisuninc.com, or Toll Free at (800)791-9458. We are available Mon-Fri 9am-5pm EST to help solve any issues that you might encounter.

NOTICE REGARDING EMISSIONS

Engines that are certified to comply with U.S. EPA emission regulations for SORE (Small Off Road Equipment), are certified to operate on regular unleaded gasoline, and may include the following emission control systems: (EM) Engine Modifications and (TWC) Three-Way Catalyst (if so equipped).

SAFETY INFORMATION

Before operating this generator, read and observe all warnings, cautions, and instructions on the generator and in this Owner's Manual.

NOTE: The following safety information is not meant to cover all possible conditions and situations that may occur. Read the entire Owner's Manual for safety and operating instructions. Failure to follow instructions and safety information could result in serious injury or death.

This safety alert symbol is used to identify safety information about hazards that can result in personal injury.



A signal word (DANGER, WARNING, or CAUTION) is used with the alert symbol to indicate the likelihood and the potential severity of injury. In addition, a hazard symbol may be used to represent the type of hazard.

DANGER Indicates a hazard, which, if not avoided, will result in death or serious injury. **WARNING**

Indicates a hazard, which, if not avoided, could result in death or serious injury. **CAUTION** Indicates a

hazard, which, if not avoided, might result in minor or moderate injury. **CAUTION** when used without

the alert symbol, indicates a situation that could result in damage to the engine or generator.

GENERAL SAFETY RULES

For any questions regarding the hazard and safety notices listed in this manual or on the product, please call (800) 791-9458, Mon-Fri 9-5 EST before using the generator. Please read and understand the instructions in this manual before starting the engine or attempting to operate this unit.

DANGER: CARBON MONOXIDE

Using a generator indoors **CAN KILL YOU IN MINUTES**. Generator exhaust contains carbon monoxide (CO). This is a poison gas you cannot see or smell. If you can smell the generator exhaust, you are breathing CO. But even if you cannot smell the exhaust, you could be breathing CO.

NEVER use a generator inside homes, garages, crawlspaces, or other partly enclosed areas. Deadly levels of carbon monoxide can build up in these areas. Using a fan or opening windows and doors does **NOT** supply enough fresh air. **ONLY** use a generator outside and far away from windows, doors, and vents. These openings can pull in generator exhaust.

Even if you use a generator correctly, CO may leak into the home. **ALWAYS** use a battery-powered or battery-backup CO alarm in the home. If you start to feel sick, dizzy, or weak after the generator has been running, move to fresh air **RIGHT AWAY**. See a doctor. You may have carbon monoxide poisoning.



WARNING: The exhaust from this product contains chemicals known to the State of California to cause cancer, birth defects, or other reproductive harm.



WARNING: This generator may emit highly flammable and explosive gasoline vapors, which can cause severe burns or even death if ignited. A nearby open flame can lead to explosion even if it isn't directly in contact with gasoline.

- Do not operate near open flame.
- Do not smoke near generator.
- Always operate on a firm, level surface.
- Always turn generator off before refueling. Allow generator to cool for at least 2 minutes before removing fuel cap. Loosen cap slowly to relieve pressure in tank.
- Do not overfill fuel tank. Gasoline may expand during operation. Do not fill to the top of the tank.
- Allow for expansion.
- Always check for spilled fuel before operating.
- Empty fuel tank before storing or transporting the generator.



WARNING: This generator produces powerful voltage, which can result in electrocution. **ALWAYS** ground the generator before using it (see the “Generating set ground” portion of the “GENERATOR PREPARATION” section).

Generator should only be plugged into electrical devices, either directly or with an extension cord. **NEVER** connect to a building electrical system without a qualified electrician. Such connections must comply with local electrical laws and codes. Failure to comply can create a back-feed, which may result in serious injury or death to utility workers.

- Use a ground fault circuit interrupter (GFCI) in highly conductive areas such as metal decking or steel work. GFCIs are available in-line with some extension cords.
- Do not use in rainy conditions.
- Do not touch bare wires or receptacles (outlets).
- Do not allow children or non-qualified persons to operate.



WARNING: This generator produces heat when running. Temperatures near exhaust can exceed 150°F (65°C).

Do not touch hot surfaces. Pay attention to warning labels on the generator identifying hot parts of the machine.

Allow generator to cool down after use before touching engine or areas of the generator that become hot during use.



CAUTION: Misuse of this generator can damage it or shorten its life.

Only use generator for its intended purposes.

Operate only on dry, level surfaces.

Allow generator to run for several minutes before connecting electrical devices.

Shut off and disconnect any malfunctioning devices from generator.

Do not exceed the wattage capacity of the generator by plugging in more electrical devices than the unit can handle.

Do not turn on electrical devices until after they are connected to the generator.

Turn off all connected electrical devices before stopping the generator.

Turn the engine switch to “OFF” position when the engine is not running.

IMPORTANT SAFETY INSTRUCTIONS

SAVE THESE INSTRUCTIONS – This manual contains important instructions for the PowerSmart® 1500W generator that should be followed during installation and maintenance of the generator.

Generators vibrate in normal use. During and after the use of the generator, inspect both the generator as well as extension and power supply cords for damage resulting from vibration. Have damaged items repaired or replaced as necessary. Do not use plugs or cords that show signs of damage such as broken or cracked insulation.











For power outages, permanently installed stationary generators are better suited for providing backup power to the home. Even a properly connected portable generator can become overloaded. This may result in overheating or stressing of the components, possibly leading to a generator failure.



WARNING: If this generator is used as a supply for a building’s wiring system, the generator must be installed by a qualified electrician and connected to a transfer switch as a separately derived system in accordance with the National Electrical Code, NFPA 70. The generator shall be connected to a transfer switch that switches all conductors excluding the equipment grounding conductor. The frame of the generator shall be connected to an approved grounding electrode.

SYMBOLS

Some of the following symbols may be used on this product. Please study them and learn their meaning. Proper interpretation of these symbols will allow you to operate the product better and safer.

SYMBOL	NAME	DESIGNATION/EXPLANATION
V	Volts	Voltage
A	Amperes	Current
Hz	Hertz	Frequency (cycles per second)
W	Watts	Power
MIN	Minutes	Time
	Safety Alert	Precautions that involve your safety.
	Read the user's manual	To reduce the risk of injury, user must read and understand user's manual before using this product.
	Carbon monoxide hazard	Never operate the generator in an enclosed area. Engine exhaust contains carbon monoxide. Only operate the generator outside and away from windows, doors and vents.
	Ground	Consult with local electrician to determine grounding requirements before operation.
	Clearance	Keep all objects at least 5 feet (1.5m) from generator. Heat from the muffler and exhaust gas can ignite combustible objects.
	Electric shock alert	Beware of electric shock hazard.
	Fire/Explosion	Fuel and its vapors are extremely flammable and explosive. Fire or explosion can cause severe burns or death. Keep generator at least 5 feet (1.5m) from all objects to prevent combustion.
	Wet conditions alert	Do not expose to rain or use in damp locations.
	Hot Surface	To reduce the risk of injury or damage, avoid contact with any hot surface.
	Open Flame Alert	Fuel and its vapors are extremely flammable and explosive. Keep fuel away from smoking, open flames, sparks, pilot lights, heat, and other ignition sources.

KNOWING YOUR GENRATOR

Use the illustrations below to become familiar with the locations and functions of the various components and controls of this generator.

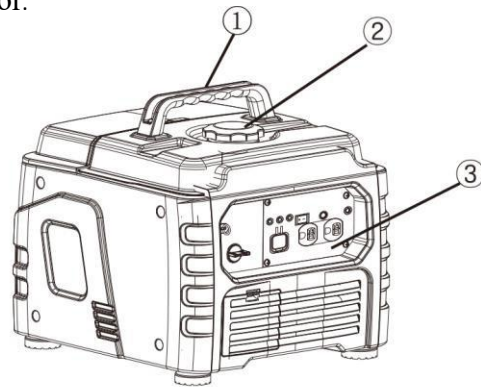

- ① Carrying handle
- ② Fuel tank cap
- ③ Control panel
- ④ Recoil starter
- ⑤ Oil filler cap
- ⑥ Louver
- ⑦ Muffler

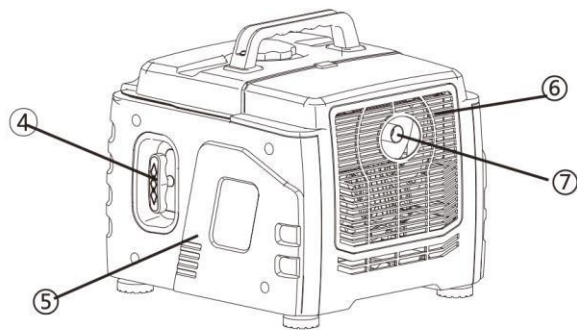

Control Panel

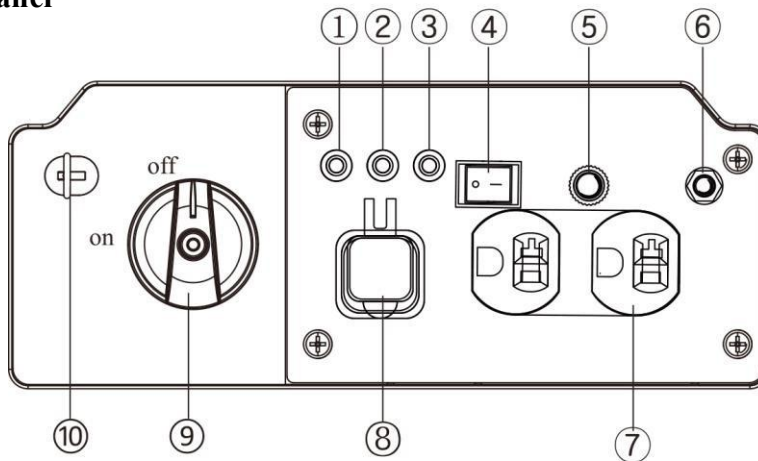

- ① Oil warning light
- ② Overload indicator light
- ③ AC pilot light
- ④ Engine switch
- ⑤ AC reset
- ⑥ Ground (earth) terminal
- ⑦ AC receptacle
- ⑧ USB
- ⑨ Fuel switch knob
- ⑩ Throttle switch

Oil warning light (red)

When the oil level falls below the lower level, the oil warning light comes on and then the engine stops automatically. Unless you refill with oil, the engine will not start again.

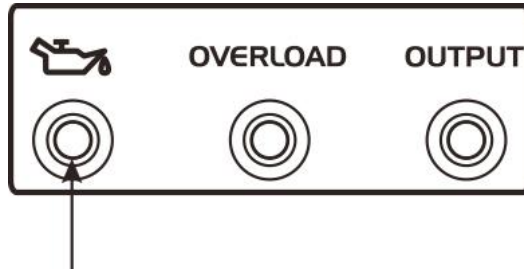

Tip: If the engine stalls or does not start, turn the engine switch to "ON" and then pull the recoil starter. If the oil warning light flickers for a few seconds, the engine oil is insufficient. Add oil and restart.

Overload indicator (red)

When the overload indicator is on, it indicates that the generating set is overload and then the AC protector works. It will stop the output of generating set to protect the electric equipment and the

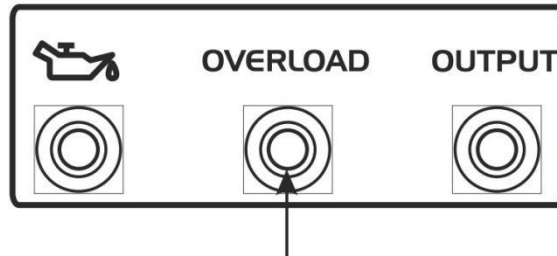

generating set itself. At this time, the running indicator (green) is off and the overload indicator (red) is on, but the engine is still in running state.

When the generating set has no output and the overload indicator is on, please take the following steps:

1. Lower the total power of the connected electric devices to the rated output range of generating set.
2. Check the air intake for impurities and check the control parts for abnormal situation. Handle immediately if necessary.
3. Press the reset button.

Running indicator (green)

The output indicator lights up when generating set starts and has normal output.

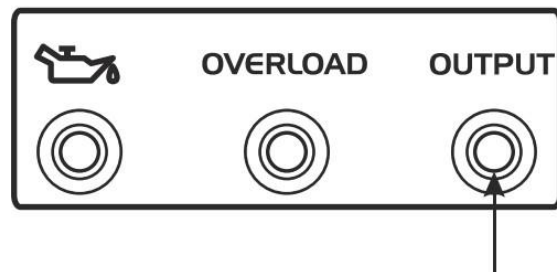

Note: If engine flames out or fails to start, turn the combination switch to "RUN" position and then pull the recoil starter. If the oil alarming lamp lights up, it shows lack of oil. Please add appropriate oil and restart the engine.

Reset button

The reset button is used to restore output if an overload occurs. To restore output, reduce the loads and press the reset button.

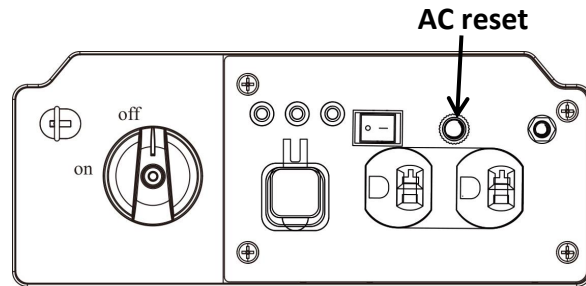

Grounding terminal

The grounding terminal is designed to prevent electric shock by connecting it to the grounding wire. The generating set must be properly grounded before operation.

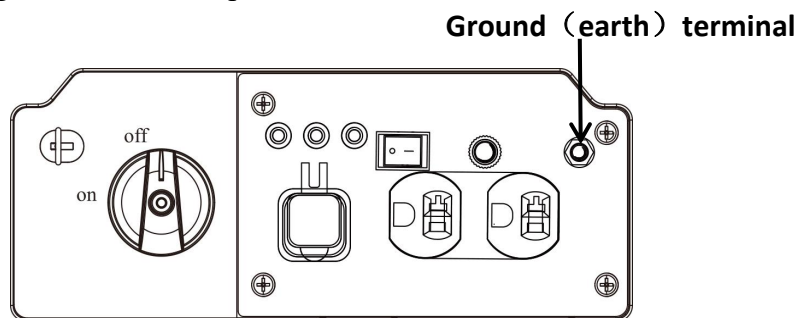

Fuel switch knob (ON&OFF)

OFF: Fuel is switched off, the engine will not run.

ON: Fuel is switched on, the engine can start.

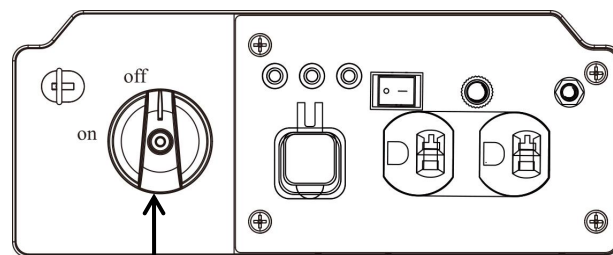

Fuel switch knob

Fuel tank cap

Remove the fuel tank cap by rotating it anticlockwise.

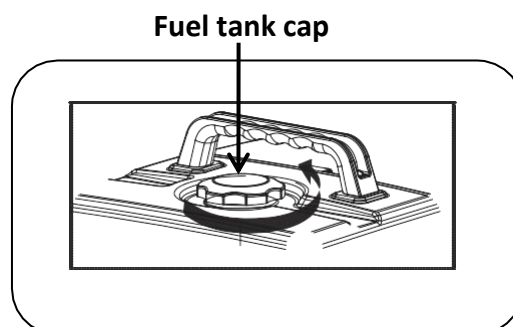

GENERATOR PREPARATION

The following section describes steps necessary to prepare the generator for use. If after reading this section, you are unsure about how to perform any of the steps please call (800) 791-9458 Mon-Fri 9-5 EST for customer service. Failure to perform these steps properly can damage the generator or shorten its lifespan.

Unpacking

Unpack the generator and all its parts. Do not discard the carton or any packaging until the generator is completely assembled.

1. Operating Location

- Only use OUTSIDE and place the generating set in a well-ventilated area.
- Only operate the generating set on a flat, level surface and in a clean, dry operating environment.
- Allow two feet clearance on all side of the generating set while operating it outdoors.
- Operate in specified area, if any problem on applicable occasion, please consult the authorized local dealers. In some areas, generating set must be registered with the local utility. Generating set used to construction sites may be subject to additional rules and regulations.



DANGER: The exhaust of the generating set contains carbon monoxide, using engine indoors **CAN KILL YOU!** NEVER use inside any building or any kind of enclosure, EVEN IF doors and windows are open. Place the generating set in a well-ventilated and clean area. Note the wind direction and air current when place the generating set.

High altitude

This generating set may require a high altitude carburetor kit to ensure correct operation at high altitudes. Consult the authorized local dealer for high altitude kit information if you always operate your engine at altitudes above 5,000 feet (1,500 meters).



CAUTION: Even with carburetor modification, generating set horsepower will decrease about 3.5% for each 1,000 feet (300 meters) increase in altitude. The effect of altitude on horsepower will be greater than this if no carburetor modification is made.

Operation the engine at altitude below 5,000 feet (1,500 meters) with modified carburetor may cause the generating set to overheat and result in serious engine damage. Please restore factory specifications of the carburetor at the dealer when using the engine in a low altitude area.

2. Operating Condition

Check for loose or damaged parts, signs of oil or fuel leaks, and any other condition that may affect proper operation. Repair or replace all damaged or defective parts immediately.



WARNING: Failing to correct problem(s) before operation could result in property damage, serious injury or DEATH.

Clean the dirt or foreign objects on the surface around exhaust and air intake of generator. DO NOT move or tip the generating set during operation. Use generating set only for intended uses. If you have questions about intended use, ask your local dealer

3. Operating Condition

Check for loose or damaged parts, signs of oil or fuel leaks, and any other condition that may affect proper operation. Repair or replace all damaged or defective parts immediately.



WARNING: Failing to correct problem(s) before operation could result in property damage, serious injury or DEATH.

Clean the dirt or foreign objects on the surface around exhaust and air intake of generator. DO NOT move or tip the generating set during operation. Use generating set only for intended uses. If you have questions about intended use, ask your local dealer.

4. Engine oil check



WARNING: This engine is not filled with oil before send out to the factory. User must add the proper amount of oil before operating the generator for the first time. Any attempt to crank or start the engine before it has been properly filled with the recommended type and amount of oil may result in engine damage and void your warranty.
The oil capacity (rated) of the engine crankcase is 9.47 fl. oz.

ENGINE OIL RECOMMENDATIONS

Only use 4-stroke engine oil of SJ,SL or equivalent level which are in accordance with or higher than API standard.

Check the API label on oil bottle or other container, and make sure the “SJ,SL” or equivalent level letter is in the label.

SAE 10W-30 is recommended for general, all-temperature use. Other viscosities shown in the chart may be used when the average temperature in your area is within the indicated range.

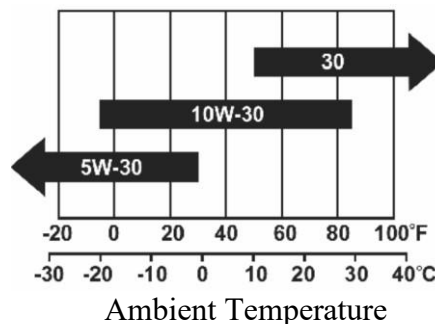

- Place the engine on a level surface with engine stopped. Check the engine oil level. Remove four screws. Remove the maintenance cover, then remove the filler cap.

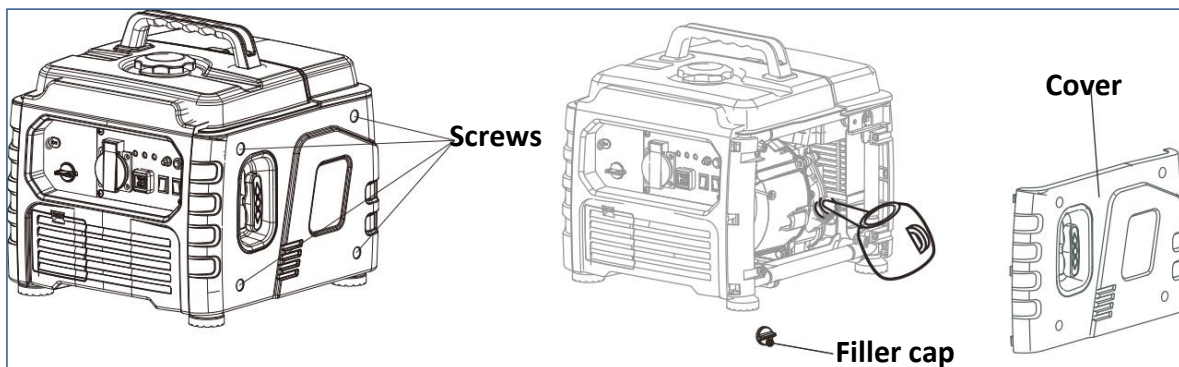

- Install dipstick into hole, rest on oil fill neck, DO NOT thread cap into hole. Fill the specified amount of the recommended engine oil, and then install and tighten the oil filler cap.

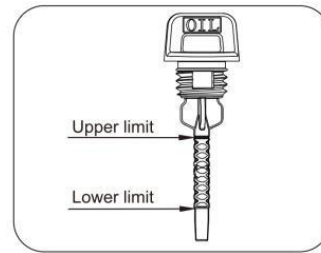
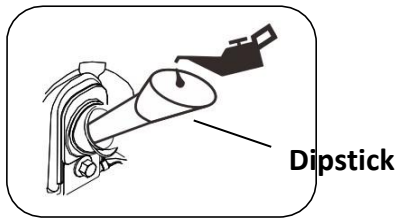

- Install the cover and tighten the screws.

CAUTION: Operate generator only on a level surfaces. The engine is equipped with a low oil sensor (applicable types) that will automatic stop the engine when the oil level falls below the safe limit. To avoid the inconvenient of an unexpected shutdown, fill to the upper limit and check the oil level regularly.

5. Generating set fuel check



WARNING: This generator may emit highly flammable and explosive gasoline vapors, which can cause severe burns or even death if ignited. A nearby open flame can lead to explosion even if not directly in contact with gasoline.

With the engine stopped, check the fuel level. Refill the fuel tank if necessary. Use clean, fresh, regular unleaded gasoline with a minimum octane rating of 87. Do not mix oil with gasoline. Always wipe up any spilled fuel.

To add gasoline, follow these steps:

1. Make sure the generator stopped and it is on a level surface.
2. Unscrew fuel cap and set aside.
NOTE: The fuel cap may be tight and hard to unscrew.
3. Slowly add unleaded gasoline to the fuel tank. Be sure not to fill above the upper limit mark. Always allow room for fuel expansion.
4. The capacity of the fuel tank is 2.8L.

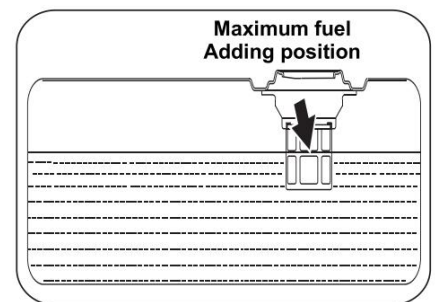

NOTE: Do not fill the fuel tank to the very top. Gasoline will expand and spill over during use even with the fuel cap in place. Reinstall fuel cap and wipe clean any spilled gasoline with a dry cloth.

IMPORTANT:

- Do not fill tank indoors.
- Do not fill tank when the engine is running or hot.
- Never use an oil/gasoline mixture.
- Never use old gasoline.
- Avoid getting dirt or water into the fuel tank.
- Gasoline can age in the tank and make starting difficult. Never store generator for extended periods of time with fuel in the tank or the carburetor.
- Turn the fuel cock off and drain the fuel from the carburetor.



CATION:

- Never use engine or carburetor cleaner products in the fuel tank or permanent damage may occur.
- It is important to prevent gum deposits from forming in essential fuel system parts, such as the carburetor, fuel filter, fuel hose or tank during storage. Also, experience indicates that
- alcohol-blended fuels (called gasohol, ethanol or methanol) can attract moisture, which leads to separation and formation of acids during storage.
- Acidic fuel can damage the fuel system of the generating set while in storage. Be sure to review the instruction given in “Storage” section.
- Gasoline/ Alcohol Blends: up to 10% alcohol, 90% unleaded gasoline by volume is approved as a fuel. Other gasoline/alcohol blends are not approved.
- Effects of old, stale or contaminated fuel are not warrantable.
- Allow the generating set to cool for at least two minutes before removing fuel cap when adding fuel.
- Loose the fuel cap slowly to relieve any pressure in the tank.

6. Generating set grounding



DANGER: Failure to properly ground the generator can result in electrocution.

The generator must be properly connected to an appropriate ground. It helps prevent electrical shock if a ground fault condition exists in the generating set or in connected electrical devices, especially when the unit is equipped with a wheel kit. Proper grounding also helps dissipate static electricity, which often builds up in ungrounded devices.

A ground terminal has been provided on the generating set. For remote grounding, connect a length of heavy gauge (4mm²) copper wire between the generating set ground terminal and a copper rod driven into the ground.

Local electrical codes may also require proper grounding of the unit. We strongly recommend that you consult with a qualified electrician for grounding requirements in your area.

ELECTRICAL DEVICES

Disconnect all electrical devices from the generator and switch off the AC circuit breaker before start the engine.

The generator may be hard to start with electrical devices.

The connected electrical equipment must not exceed the maximum limit of the generator. Please refer to the specification table for details.

NOTE: After completing the above preparation, the generator is ready to be started.

STARTING THE GENERATOR



CAUTION: Disconnect all electrical loads from the generator before attempting to start.

Pull the starter handle 6-8 times to prefill fuel system before initial operation or removal from long term storage. Failure to do so could result in bad starting experience.

1. Perform generator preparation (see page. 11) and remove all loads.
2. Cold start

Turn the engine switch to “ON”.

Pull the chock out.

Turn the fuel switch knob to “ON”

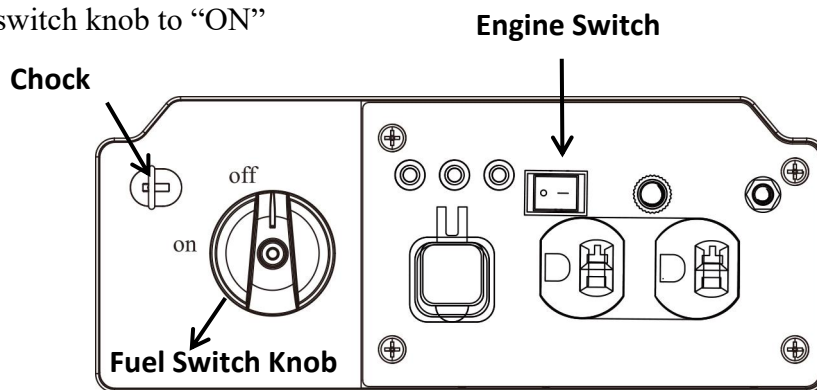

3. Manual start



WARNING: Check starter cord conditions before operating. Have it replaced immediately by local authorized dealer if cord is frayed.

When starting engine, grasp the recoil starter handle and pull slowly until resistance is felt. Then pull rapidly to avoid kickback. When pulling the recoil starter, firmly grasp the carrying handle to avoid tumble of generating set.

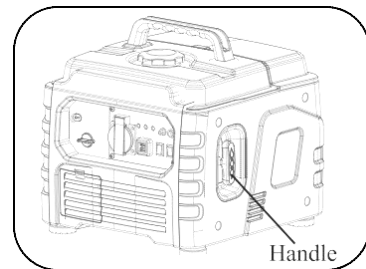

WARNING: KICKBACK

Rapid retraction of the starter cord will pull hand and arm towards the engine faster than you can let go. Unintentional startup can result in entanglement, traumatic amputation or laceration. Broken bones, fractures, bruises or sprains could result.

USING THE GENERATOR



WARNING: It is prohibited to start or close the generating set when the output terminal of generating set is connected to an electric device is in “ON” state.

CONNECT TO ELECTRICAL DEVICES

1. Inspect power cord for damage before using. There is a hazard of electrical shock from crushing, cutting or heat damage.
2. Make sure that the generating set has been properly grounded. If the electric devices require grounding, the generating set must ground.
3. Make sure that the electric devices are in “OFF” position.
4. Allow the engine to stabilize and warm up for a few minutes after starting.
5. Connect and start the electric devices.
6. Turn off all electric devices and disconnect them from the generating set.
7. If the generating set supplies for several loads or electric devices, start the smallest one first and the largest one last.



DANGER: If connected devices overheat, turn them off and disconnect them from generating set.

Electrical Shock

To reduce the risk of electrical shock, DO NOT use electrical cords that are worn, frayed, bare or otherwise damaged. DO NOT touch bare wires or receptacles. DO NOT handle generating set or electrical cords while standing in water, while barefoot, or while hands or feet are wet.

LOADING CAPACITY



WARNING: Do not overload the generating set. Exceeding the generating set’s capacity can damage the generating set and/or electric devices connected to it.

You must make sure your generating set can supply enough rated (running) and (starting) watts for the electrical devices at the same time. Follow these simple steps to calculate the running and starting watts necessary for your purposes.

1. Count the electrical devices you will power at the same time.
2. The amount of power you need to run with the devices is the total rated (running) watts of these items.
3. Starting power is the power needed shortly when electric devices start. Since not all devices start at the same time, starting power can be estimated by the maximum power of all devices plus the total power counted in step 2.

Electric equipment		Rate power(W)	Starting power(W)
Appliances	Tablet computer27”	80	100
	Energy saving lamb	5-50	5-50
	Electric cooker	1000	1000
	Computer	250	250
	Electric fan	50	100
	Washing machine	250	500
	Refrigerator	50	300
	Air-conditioner	1600	3200
Electric tooling	Electric hammer	1000	1500
	Impact Hammer	3000	6000
	Water pump	2200	5000
	Electric welding machine	5000	7500
	Air compressor	5000	10000

Wattage Reference Chart



WARNING: It is necessary to equip with circuit protector or switch to isolate the generating set from the electric utility when the generating set is mainly used for backup. Failure to isolate the generating set from the power utility may result in injury or death to electric utility workers and damage to the generating set due to back feed of electrical energy.

STOPPING THE GENERATOR



WARNING: Never stop the engine with electrical devices connected and with the connected devices turn “ON”.

1. Remove the connectors of all electric equipment from the generating set panel.

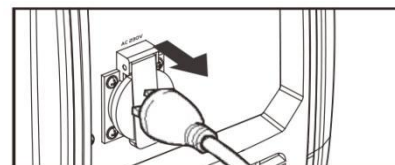

2. Turn the Fuel switch to “OFF” position, the generator stops operation.

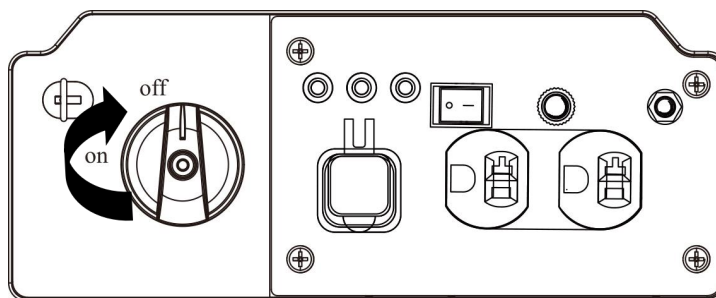

MAINTENANCE

It is the operator’s responsibility to complete all scheduled maintenance in a timely manner. Correct any issue before operating the generating set. Always follow the inspection and maintenance recommendations and schedules in this manual.



WARNING: Improper maintenance or failure correct a problem before operation can cause a malfunction and result in property damage, serious injury or DEATH. Improper maintenance will void your warranty.



DANGER: Accidental starts can cause severe injury or death. Remove the spark plug cap and ground generating set before performing any service.



WARNING: The filter element may contains PAHs, PAHs are harmful for your health. Please wear gloves for protection during air filter maintenance.

MAINTENANCE SCHEDULE

Items		Frequency		First 1 month or first 20hrs of operation	Thereafter, every 3 months or every 50hrs of operation	Every year or every 100 hrs of operation
		Each time				
Engine oil	Check-Refill	✓				
	Replace		✓	✓		
Reduction gear oil(if equipped)	Oil level check	✓				
	Replace		✓	✓		
Air filter element	Check	✓				
	Clean		✓			
	Replace			✓		
Deposit Cup (if equipped)	Clean					✓
Spark Plug	Check-adjust					✓
	Replace	Every year or 250 hrs of operation				
Spark arrester	Clean			✓		
Idling (if equipped)*	Check-adjust					✓
Valve clearan- ce *	Check-adjust					✓
Fuel tank & fuel filter *	Clean					✓
Fuel line	Check	Every 2 years(change if necessary)				
Cylinder head, piston	Clean up carb- on *	<225cc, Every 125hrs ≥ 225cc, Every 250hrs				
* These items should be maintained and repaired by our authorized dealer, unless the owner has appropriate tools and is proficient with mechanical maintenance.						

Stop the generating set before serving, disconnect all electric devices and battery (If equipped), and cool down the generating set completely.

Serve the generating set in a clean, dry and flat area, so that no accident would happen during the serving. Please make the wheel in brake state to stop accidental movement of generating set.

Follow the service intervals indicated in the chart below. Service your generating set more frequently when operating in adverse conditions.

Contact your local authorized service dealer for your generating set or engine maintenance needs.

NOTICE

- If the gasoline engine frequently works under high temperature or heavy load, change the oil every 25 hours.
- If the engine frequently work under dusty or other severe circumstances, clean the air filter element every 10 hours; If necessary, change the air filter element every 25 hours.
- If maintenance period and the exact time(hour), the one which comes first should govern.
- If you have missed the scheduled time to maintain your engine, do it as soon as possible.

GENERATING SET MAINTENANCE



WARNING: Never clean the generator when it is running! Never use water to clean the generating set. Water can enter the generating set through the cooling slots and damage the generating set windings.



WARNING: Do not modify the generator in any way. Do not tamper with governed speed. Generator supplies correct rated frequency and voltage when running at factory set. Tampering with the factory set governor will void your warranty.

- Make certain that the generator is kept clean and stored properly.
- Use a damp cloth to clean exterior surfaces of the generating set. Use a soft brush to clean the dirt and oil.
- Use an air compressor (25 PSI) to clear dirt and debris from the generating set.
- Inspect all air vents and cooling slots to ensure that they are clean and unobstructed.

ENGINE MAINTENANCE

Changing the oil



WARNING: Change the oil when the engine is warm from operation. The oil can reach up to 140°C under that condition. Careful operation should be taken to prevent burns.

1. Place the machine on a level surface which is 300mm higher than the ground.
2. Remove the right cover.
3. Place the waste oil box on the ground.
4. Remove the oil dipstick, and tilt the machine to pour the oil.
5. Add recommended oil to the upper limit.
6. Fully tighten the dipstick.
7. Properly dispose of any used oil at an approved waste management facility.
8. Reinstall the oil maintenance cover.

AIR FILTER



WARNING: Do not run the engine without the air filter, or serious danger can result.

Routine maintenance of the air cleaner helps maintain proper airflow to the carburetor. Occasionally check that the air cleaner is free of excessive dirt.

1. Remove the air filter maintenance cover.
2. Loosen the filter fix clamp and remove the cover of the air filter.
3. Remove the foam filter element.
4. Wash in liquid detergent and warm water.
5. Squeeze thoroughly dry in a clean cloth.
6. Saturate in clean engine oil.
7. Squeeze in a clean, absorbent cloth to remove all excess oil.
8. Assemble the filter element onto the filter unit.
9. Assemble the filter fix clamp.
10. Reinstall the air filter maintenance cover.

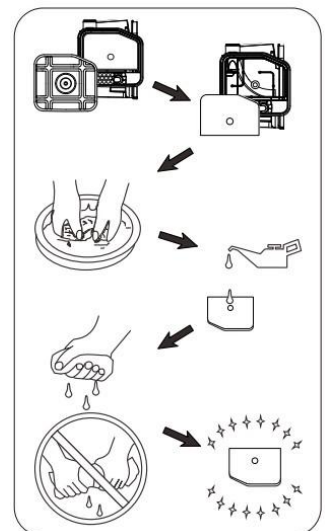

SPARK PLUG

Spark plug gap : 0.6mm-0.8mm(0.024-0.031 in). Spark plug tighten torque: 12.5N.m

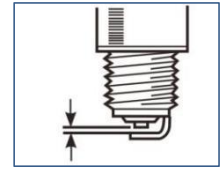

The spark plug is important for proper engine operation. A good spark plug should be intact, free of deposits, and properly gapped. Refer to Recommended Maintenance Schedule. To inspect the spark plug:

1. Clean any dirt from the spark plug cap and spark plug base.
2. Remove the cap (a) and the spark plug cap (b), Insert the tool through the hole from the outside of the cover.
3. Insert the handlebar (c) into the tool (d) and turn it counterclockwise to remove the spark plug.
4. Check for discoloration and remove the carbon. The porcelain insulator around the center electrode of spark plug should be a medium-to-light tan color.

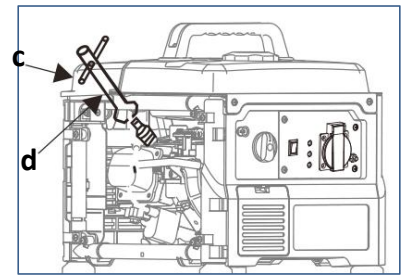
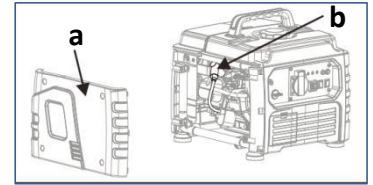

CAUTION: Only use recommended spark plug or equivalent. Do not use spark plugs that have improper heat range.

FUEL TANK FILTER



WARNING: Never use the gasoline while smoking or in the vicinity of an open flame.

1. Remove the fuel tank cap and filter.
 2. Clean the filter with gasoline.
 3. Wipe the filter and install it.
 4. Install the fuel tank cap.
- Be sure the fuel tank cap is tightened securely.

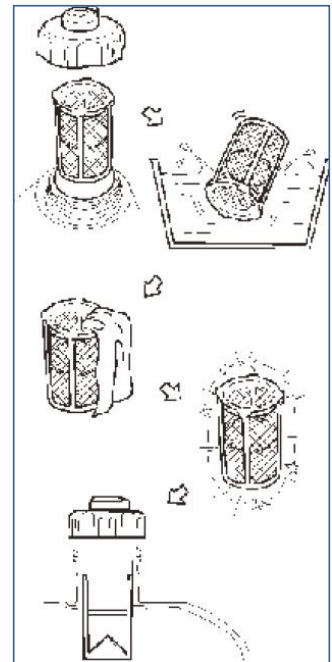

FUEL FILTER

1. Remove the screws, take the cover down and drain the fuel.
2. Hold and move up the clamp, take off the hose from the tank.
3. Take out the fuel filter.
4. Clean the filter with gasoline.
5. Dry the filter and put it back into tank.
6. Install the hose and clamp, then open the fuel valve to check whether it is leak.
7. Install the cover and tighten the screws.

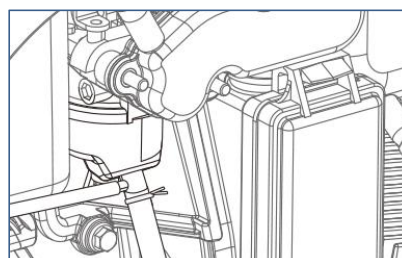
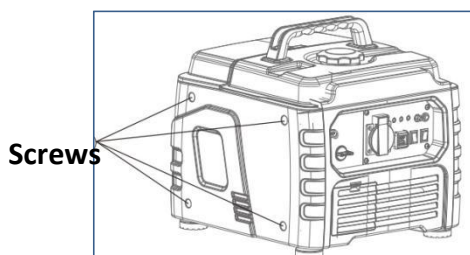

STORAGE & TRANSPORT PROCEDURES

STORAGE



WARNING: Gasoline is highly flammable and extremely explosive. Empty the fuel tank and shut off fuel valve before storing or transporting this generating set.

The generating set should be started at least once every 2 weeks and allowed to run for at least 20 minutes. Follow the instructions below for longer term storage if the generating set will be out of service for 2 months or more.

- Allow the generating set to cool completely before storage.
- Clean the generating set according to instruction in maintenance section.
- Drain all fuel completely from the fuel tank, fuel hose and carburetor to prevent gum from forming.
- Turn off the fuel supply at the fuel valve.
- Change the oil.
- Reattach the spark plug.
- Remove the spark plug and pour about 15ml of oil into the cylinder. Crank the engine slowly to distribute the oil and lubricate the cylinder.
- Store the unit in a clean, dry area out of direct sunlight.

TRANSPORT

To prevent fuel spillage when transporting or during temporary storage, the generating set should be secured upright in its normal operating position, with the engine switch OFF. The combination switch should be in the “stop” position and knob of the fuel cap should be turned to the “OFF” position.

When transporting:

- Do not overfill the tank.
- Do not operate the generating set while it is on vehicle. Take the generating set off the vehicle and use it in a well-ventilated place. Avoid a place exposed to direct sunlight when putting the generating set on a vehicle. If the generating set is left in an enclosed vehicle for many hours, high temperature inside the vehicle could cause fuel to vaporize resulting in a possible explosion.
- Do not drive on a rough road for an extended period with the generating set on a rough road, drain the fuel from the generating set beforehand.

TROUBLESHOOTING

ENGINE WON'T START

1. Fuel systems

No fuel supplied to combustion chamber.

- No fuel in tank...Supply fuel.
- Clogged fuel filter Clean fuel filter.
- Clogged carburetor.... Clean carburetor.

2. Engine oil system

Insufficient

- Oil level is low.... Add engine oil.

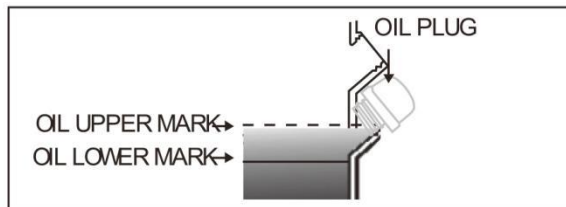

3. Electrical systems

- Pull the choke out and pull the recoil starter ... Poor spark.
- Spark plug dirty with carbon or wet ... Remove carbon or wipe spark plug dry.
- Faulty ignition system ... consult our company authorized dealer.

GENERATOR WON'T PRODUCE POWER

- The AC pilot light (Green) go off Stop the engine, then restart.

WIRING DIAGRAM

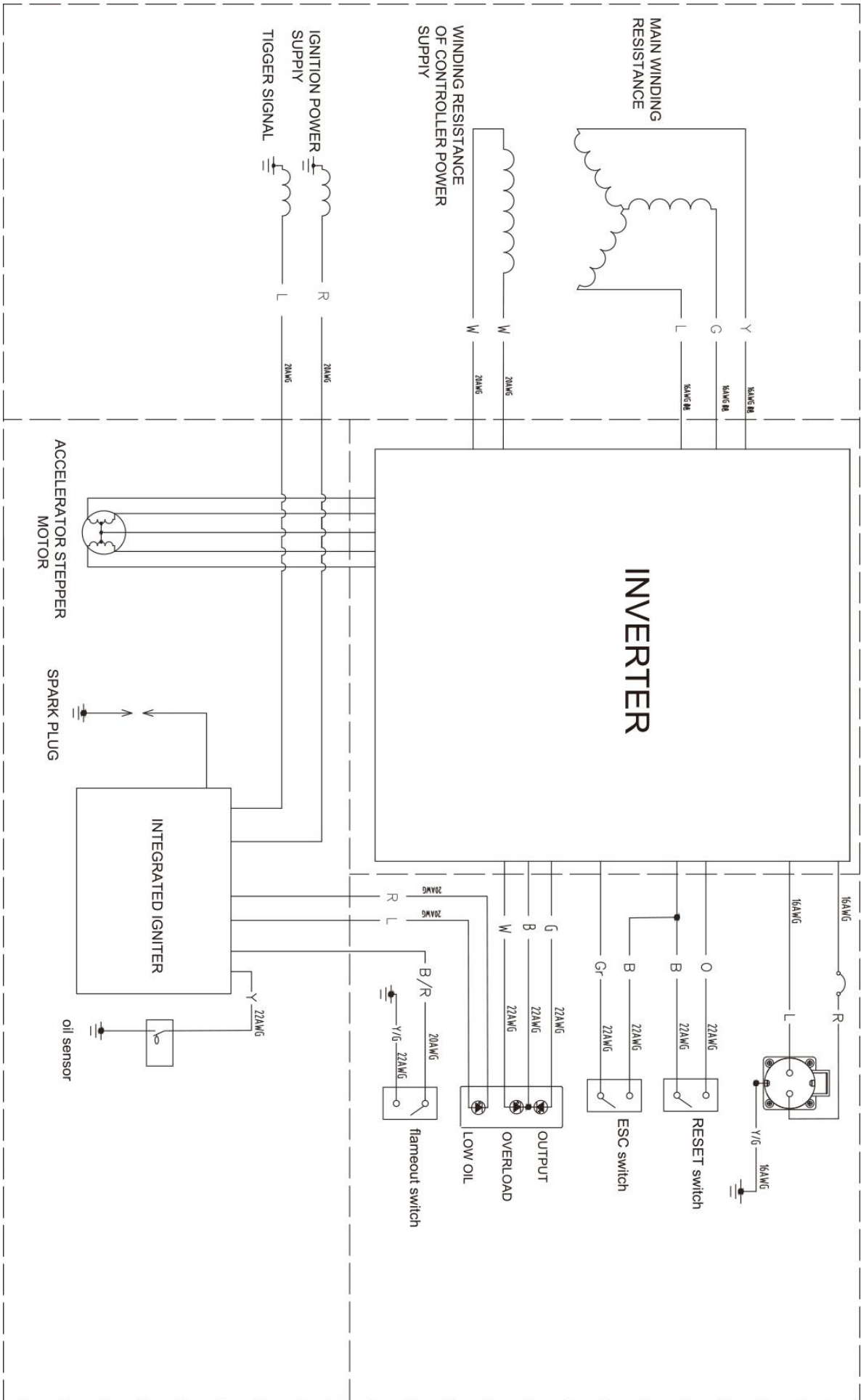

EXPLODED VIEW & PARTS LIST

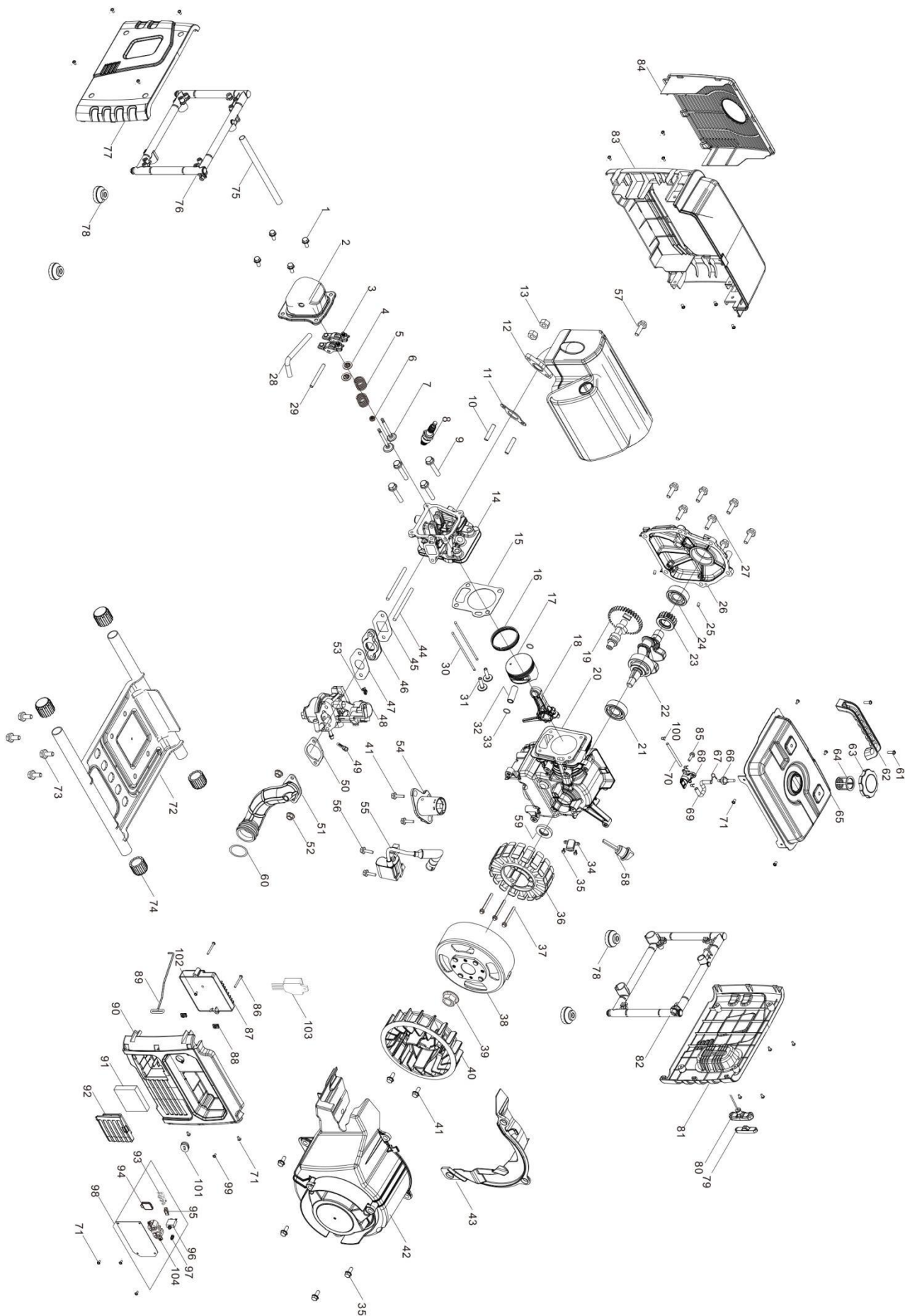

Generator parts list

Item	Stock #	Description	Qty
1	PS55-001	BOLT	4
2	PS55-002	COVER SUBASSEMBLY, CYLINDER HEAD	1
3	PS55-003	ROCKER SUBASSEMBLY, VALVE	2
4	PS55-004	SEAT, VALVE SPRING	2
5	PS55-005	SPRING, VALVE	2
6	PS55-006	GUIDE, SEAL	1
7	PS55-007	VALVES SET	1
8	PS55-008	PLUG, SPARK	1
9	PS55-009	BOLT	4
10	PS55-010	STUD BOLT	2
11	PS55-011	GASKET, EXHAUST OUTLET	1
12	PS55-012	MUFFLER ASSY.	1
13	PS55-013	HEXAGON NUT	2
14	PS55-014	HEAD SUBASSEMBLY, CYLINDER	1
15	PS55-015	GASKET, CYLINDER HEAD	1
16	PS55-016	RING ASSY, PISTON	1
17	PS55-017	PISTON	1
18	PS55-018	ROD, CONNECTING	1
19	PS55-019	CAMSHAFT ASSY.	1
20	PS55-020	CRANKCASE SUBASSEMBLY.	1
21	PS55-021	DEEP GROOVE BALL BEARING	1
22	PS55-022	CRANKSHAFT ASSY.	1
23	PS55-023	GEAR, TIMING DRIVE	1
24	PS55-024	DEEP GROOVE BALL BEARING	1
25	PS55-025	POSITION PIN - TYPE A	2
26	PS55-026	COVER, CRANKCASE	1
27	PS55-027	BOLT	6
28	PS55-028	TUBE, BREATHER	1
29	PS55-029	SHAFT, VALVE ROCKER	1
30	PS55-030	LIFTER SUBASSEMBLY, VALVE	2
31	PS55-031	TAPPET, VALVE	2
32	PS55-032	PIN, PISTON	1
33	PS55-033	CLIP, PISTON PIN	2
34	PS55-034	TRIGGER ASSY.	1
35	PS55-035	BOLT	6
36	PS55-036	STATOR SUBASSEMBLY, MAGNETO	1
37	PS55-037	HEXAGON SOCKET FLANGE FACE BOLT - SMALL SERIES	3
38	PS55-038	CASE SUBASSEMBLY, MAGNETO ROTOR	1
39	PS55-039	HEXAGON NUT WITH FLANGE	1
40	PS55-040	IMPELLER	1
41	PS55-041	BOLT	4
42	PS55-042	MANUAL STARTING ASSEMBLY	1
43	PS55-043	SHIELD, CRANKCASE REAR	1
44	PS55-044	STUD BOLT (BM=2D)	2
45	PS55-045	GASKET, CARBURETOR INSULATOR	1
46	PS55-046	PLATE, CARBURETOR INSULATOR	1
47	PS55-047	CARBURETOR SEAL GASKET	1

48	PS55-048	CARBURETOR ASSY.	1
49	PS55-049	STRAINER, FUEL	1
50	PS55-050	AIR CLEANER SEAL GASKET	1
51	PS55-051	AIR CLEANER INTAKE DUCT ASSEMBLY	1
52	PS55-052	HEXAGON NUT WITH FLANGE	2
53	PS55-053	CLIP, GOVERNOR ROD	1
54	PS55-054	SENSOR, ENGINE OIL	1
55	PS55-055	COIL, IGNITION	1
56	PS55-056	BOLT	2
57	PS55-057	BOLT	1
58	PS55-058	DIPSTICK SUBASSEMBLY, OIL	1
59	PS55-059	SEAL, OIL	1
60	PS55-060	CLIP	1
61	PS55-061	CROSS-RECESSED PAN HEAD SCREW	2
62	PS55-062	HANDLE	1
63	PS55-063	COVER, FUEL TANK	1
64	PS55-064	STRAINER, FUEL	1
65	PS55-065	FUEL TANK	1
66	PS55-066	OUTLET SUBASSEMBLY, FUEL TANK OIL	1
67	PS55-067	COLLAR	1
68	PS55-068	COCK ASSY, FUEL	1
69	PS55-069	TUBE, FUEL	1
70	PS55-070	TUBE, FUEL	1
71	PS55-071	SELF-TAPPING SCREW	26
72	PS55-072	ENGINE FIXED BOTTOM PLATE	1
73	PS55-073	BOLT	4
74	PS55-074	BUFFERING PAD SUPPORT	4
75	PS55-075	PIPE, ENGINE FRAME CONNECTING	1
76	PS55-076	FRAME ASSY, ENGINE	1
77	PS55-077	LEFT HOUSING COVER PLATE	1
78	PS55-078	SEAT, ENGINE FRAME SHOCK ABSORPTION	4
79	PS55-079	CORE, CABLE HANDLE	1
80	PS55-080	SLEEVE, CABLE HANDLE OUTER	1
81	PS55-081	RIGHT APPEARANCE COVER PLATE	1
82	PS55-082	FRAME ASSY, ENGINE	1
83	PS55-083	COVER, MUFFLER SIDE	1
84	PS55-084	COVER, MUFFLER SIDE	1
85	PS55-085	BOLT	1
86	PS55-086	HEXAGON SOCKET FLANGE FACE BOLT - SMALL SERIES	2
87	PS55-087	INVERTOR	1
88	PS55-088	CLIP NUT	2
89	PS55-089	CHOKE PULL ROD	1
90	PS55-090	SEAT, PANEL	1
91	PS55-091	ELEMENT, AIR CLEANER	1
92	PS55-092	COVER, AIR CLEANER CASE	1
93	PS55-093	STATUS DISPLAY BOARD ASSEMBLY	1
94	PS55-094	SOCKET SUBASSEMBLY, D.C	1
95	PS55-095	SWITCH SUBASSEMBLY	1
96	PS55-096	BUTTON, RESETTING	1
97	PS55-097	TERMINAL SUBASSEMBLY, GROUNDING	1
98	PS55-098	PANEL SUBASSEMBLY, CONTROL	1

99	PS55-099	BOLT	1
100	PS55-100	COLLAR	3
101	PS55-101	PLUG, END	1
102	PS55-102	CROSS-RECESSED PAN HEAD SCREW	1
103	PS55-103	REGULATOR, VOLTAGE	1
104	PS55-104	SOCKET SUBASSEMBLY, POWER SUPPLY	1

THREE (3) YEARS LIMITED WARRANTY

PowerSmart® is committed to building tools that are dependable for years. Our warranties are consistent with our commitment and dedication to quality.

THREE (3) YEARS LIMITED WARRANTY OF POWERSMART PRODUCTS FOR HOME USE.

PowerSmart ("Seller") warrants to the original purchaser only, that all PowerSmart consumer power tools will be free from defects in material or workmanship for a period of three (3) years from date of purchase. Ninety (90) days for all PowerSmart Products, if the tool is used for professional or commercial use.

SELLER'S SOLE OBLIGATION AND YOUR EXCLUSIVE REMEDY under this Three (3) Years Limited Warranty and, to the extent permitted by law, any warranty or condition implied by law, shall be the repair or replacement of parts, without charge, which are defective in material or workmanship and which have not been misused, carelessly handled, or misrepaired by persons other than Seller or Authorized Service Center. To make a claim under this Limited Warranty, you must return the entire power tool product; transportation prepaid, to PowerSmart Include a legible copy of the original receipt, which lists the date of purchase (month and year) and the name of the company purchased from.

THIS LIMITED WARRANTY DOES NOT APPLY TO ANY ACCESSORY ITEMS INCLUDED WITH THE TOOL SUCH AS CIRCULAR SAW BLADES OTHER RELATED ITEMS OR TO ANY REPLACEMENT PARTS LISTED UNDER MAINTENANCE.

ANY IMPLIED WARRANTIES SHALL BE LIMITED IN DURATION TO THREE (3) YEARS FROM DATE OF PURCHASE. SOME STATES IN THE U.S. AND SOME CANADIAN PROVINCES DO NOT ALLOW LIMITATIONS ON HOW LONG AN IMPLIED WARRANTY LASTS, SO THE ABOVE LIMITATION MAY NOT APPLY TO YOU.

IN NO EVENT SHALL SELLER BE LIABLE FOR ANY INCIDENTAL OR CONSEQUENTIAL DAMAGES (INCLUDING BUT NOT LIMITED TO LIABILITY FOR LOSS OF PROFITS) ARISING FROM THE SALE OR USE OF THIS PRODUCT. SOME STATES IN THE U.S. AND SOME CANADIAN PROVINCES DO NOT ALLOW THE EXCLUSION OR LIMITATION OF INCIDENTAL OR CONSEQUENTIAL DAMAGES, SO THE ABOVE LIMITATION OR EXCLUSION MAY NOT APPLY TO YOU.

THIS LIMITED WARRANTY GIVES YOU SPECIFIC LEGAL RIGHTS, AND YOU MAY ALSO HAVE OTHER RIGHTS WHICH VARY FROM STATE TO STATE IN THE U.S., PROVINCE TO PROVINCE IN CANADA AND FROM COUNTRY TO COUNTRY.

For questions / comments, technical assistance or repair parts –
Please call toll free at: 1-800-791-9458 (M-F 9am – 5pm EST)
Email: support@amerisuninc.com

SAVE YOUR RECEIPTS. THIS WARRANTY IS VOID WITHOUT THEM.