

# POWER SMART<sup>®</sup>

## INSTRUCTION MANUAL

### 3500W Inverter Generator

Model # PS5035

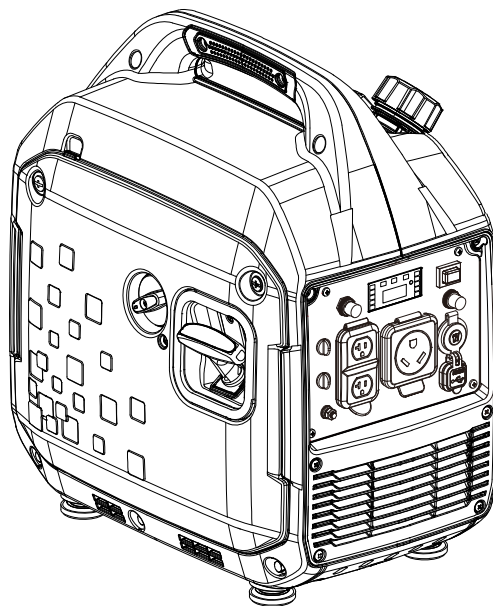

Have product questions or need technical support? Please scan the QR code to enter our official website and contact us!

Website: [www.powersmartusa.com](http://www.powersmartusa.com)

Toll free: 1-800-791-9458 M-F 9-5 EST

Email: [support@amerisuninc.com](mailto:support@amerisuninc.com)



Website



## **CONTENTS**

Technical data.....	3
Introduction.....	4
Safety information.....	4
General safety rules .....	5
Important safety instructions.....	6
Symbols.....	7
Knowing your generator.....	8
Generator preparation.....	12
Starting the generator.....	16
Using the generator.....	16
Stopping the generator.....	18
Maintenance.....	18
Storage & transport procedures.....	22
Troubleshooting.....	23
Wiring diagram.....	24
Exploded view & parts list.....	25
Warranty statement.....	30

## **TECHNICAL DATA**

3500W Inverter Generator	Model # PS5035
Engine type:	4 stroke, OHV, single cylinder with forced air-cooling system
Start type:	Manual
Phase:	Single
Rated wattage:	2700W
Starting wattage:	3500W
Rated voltage:	120V
Rated current:	22.5A
DC output voltage:	12V
DC Amps:	8.3A
Frequency:	60Hz
Displacement:	149cc
Spark plug gap:	0.6-0.8 mm (0.024-0.031 in.)
Fuel tank capacity:	1.53 gallons
Oil capacity:	19.6 fl.oz
USB output voltage:	5V
Package dimensions(L x W x H):	21.3x14.2x20.7 inches
Weight:	72.8lbs

## **INTRODUCTION**

Thank You for Purchasing a PowerSmart® Product. This manual provides information regarding the safe operation and maintenance of this product. Every effort has been made to ensure the accuracy of the information in this manual. PowerSmart® reserves the right to change this product and specifications at any time without prior notice.



Please keep this manual available to all users during the entire life of the generator.

This manual contains special messages to bring attention to potential safety concerns, generator damage as well as helpful operating and servicing information. Please read all the information carefully to avoid injury and machine damage.

## **QUESTIONS? PROBLEMS?**

Please contact our Customer Service Dept. with any questions and/or comments, either by Email: support@amerisuninc.com, or Toll Free at (800)791-9458. We are available Mon-Fri 9am-5pm EST to help solve any issues that you might encounter.

## **NOTICE REGARDING EMISSIONS**

Engines that are certified to comply with U.S. EPA emission regulations for SORE (Small Off Road Equipment), are certified to operate on regular unleaded gasoline, and may include the following emission control systems: (EM) Engine Modifications and (TWC) Three-Way Catalyst (if so equipped).

## **SAFETY INFORMATION**

Before operating this generator, read and observe all warnings, cautions, and instructions on the generator and in this Owner's Manual.

NOTE: The following safety information is not meant to cover all possible conditions and situations that may occur. Read the entire Owner's Manual for safety and operating instructions. Failure to follow instructions and safety information could result in serious injury or death.

This safety alert symbol is used to identify safety information about hazards that can result in personal injury.



A signal word (DANGER, WARNING, or CAUTION) is used with the alert symbol to indicate the likelihood and the potential severity of injury. In addition, a hazard symbol may be used to represent the type of hazard.

**DANGER** Indicates a hazard, which, if not avoided, will result in death or serious injury.

**WARNING** Indicates a hazard, which, if not avoided, could result in death or serious injury.

**CAUTION** Indicates a hazard, which, if not avoided, might result in minor or moderate injury.

**CAUTION** when used without the alert symbol, indicates a situation that could result in damage to the engine or generator.



## GENERAL SAFETY RULES

For any questions regarding the hazard and safety notices listed in this manual or on the product, please call (800) 791-9458 Mon-Fri 9-5 EST before using the generator. Please read and understand the instructions in this manual before starting the engine or attempting to operate this unit.

### **DANGER: CARBON MONOXIDE**

Using a generator indoors **CAN KILL YOU IN MINUTES**. Generator exhaust contains carbon monoxide (CO). This is a poison gas you cannot see or smell. If you can smell the generator exhaust, you are breathing CO. But even if you cannot smell the exhaust, you could be breathing CO.

**NEVER** use a generator inside homes, garages, crawlspaces, or other partly enclosed areas. Deadly levels of carbon monoxide can build up in these areas. Using a fan or opening windows and doors does **NOT** supply enough fresh air. **ONLY** use a generator outside and far away from windows, doors, and vents. These openings can pull in generator exhaust.

Even if you use a generator correctly, CO may leak into the home. **ALWAYS** use a battery-powered or battery-backup CO alarm in the home. If you start to feel sick, dizzy, or weak after the generator has been running, move to fresh air **RIGHT AWAY**. See a doctor. You may have carbon monoxide poisoning.



**WARNING:** The exhaust from this product contains chemicals known to the State of California to cause cancer, birth defects, or other reproductive harm.



**WARNING:** This generator may emit highly flammable and explosive gasoline vapors, which can cause severe burns or even death if ignited. A nearby open flame can lead to explosion even if it isn't directly in contact with gasoline.

- Do not operate near open flame.
- Do not smoke near generator.
- Always operate on a firm, level surface.
- Always turn generator off before refueling. Allow generator to cool for at least 2 minutes before removing fuel cap. Loosen cap slowly to relieve pressure in tank.
- Do not overfill fuel tank. Gasoline may expand during operation. Do not fill to the top of the tank. Allow for expansion.
- Always check for spilled fuel before operating.
- Empty fuel tank before storing or transporting the generator.



**WARNING:** This generator produces powerful voltage, which can result in electrocution.

**ALWAYS** ground the generator before using it (see the “Generating set ground” portion of the “GENERATOR PREPARATION” section).

Generator should only be plugged into electrical devices, either directly or with an extension cord.

**NEVER** connect to a building electrical system without a qualified electrician. Such connections must comply with local electrical laws and codes. Failure to comply can create a back-feed, which may result in serious injury or death to utility workers.

- Use a ground fault circuit interrupter (GFCI) in highly conductive areas such as metal decking or steel work. GFCIs are available in-line with some extension cords.
- Do not use in rainy conditions.
- Do not touch bare wires or receptacles (outlets).
- Do not allow children or non-qualified persons to operate.



**WARNING:** This generator produces heat when running. Temperatures near exhaust can exceed 150°F (65° C).

Do not touch hot surfaces. Pay attention to warning labels on the generator identifying hot parts of the machine.

Allow generator to cool down after use before touching engine or areas of the generator that become hot during use.



**CAUTION:** Misuse of this generator can damage it or shorten its life.

Only use generator for its intended purposes.

Operate only on dry, level surfaces.

Allow generator to run for several minutes before connecting electrical devices.

Shut off and disconnect any malfunctioning devices from generator.

Do not exceed the wattage capacity of the generator by plugging in more electrical devices than the unit can handle.

Do not turn on electrical devices until after they are connected to the generator.

Turn off all connected electrical devices before stopping the generator.

Turn the engine switch to “OFF” position when the engine is not running.

## **IMPORTANT SAFETY INSTRUCTIONS**

SAVE THESE INSTRUCTIONS – This manual contains important instructions for the PowerSmart® 3500W generator that should be followed during installation and maintenance of the generator.

Generators vibrate in normal use. During and after the use of the generator, inspect both the generator as well as extension and power supply cords for damage resulting from vibration. Have damaged items repaired or replaced as necessary. Do not use plugs or cords that show signs of damage such as broken or cracked insulation.











For power outages, permanently installed stationary generators are better suited for providing backup power to the home. Even a properly connected portable generator can become overloaded. This may result in overheating or stressing of the components, possibly leading to a generator failure.



**WARNING:** If this generator is used as a supply for a building’s wiring system, the generator must be installed by a qualified electrician and connected to a transfer switch as a separately derived system in accordance with the National Electrical Code, NFPA 70. The generator shall be connected to a transfer switch that switches all conductors excluding the equipment grounding conductor. The frame of the generator shall be connected to an approved grounding electrode.

## SYMBOLS

Some of the following symbols may be used on this product. Please study them and learn their meaning. Proper interpretation of these symbols will allow you to operate the product better and safer.

SYMBOL	NAME	DESIGNATION/EXPLANATION
V	Volts	Voltage
A	Amperes	Current
Hz	Hertz	Frequency (cycles per second)
W	Watts	Power
MIN	Minutes	Time
	Safety Alert	Precautions that involve your safety.
	Read the user's manual	To reduce the risk of injury, user must read and understand user's manual before using this product.
	Carbon monoxide hazard	Never operate the generator in an enclosed area. Engine exhaust contains carbon monoxide. Only operate the generator outside and away from windows, doors and vents.
	Ground	Consult with local electrician to determine grounding requirements before operation.
	Clearance	Keep all objects at least 5 feet (1.5m) from generator. Heat from the muffler and exhaust gas can ignite combustible objects.
	Electric shock alert	Beware of electric shock hazard.
	Fire/Explosion	Fuel and its vapors are extremely flammable and explosive. Fire or explosion can cause severe burns or death. Keep generator at least 5 feet (1.5m) from all objects to prevent combustion.
	Wet conditions alert	Do not expose to rain or use in damp locations.
	Hot Surface	To reduce the risk of injury or damage, avoid contact with any hot surface.
	Open Flame Alert	Fuel and its vapors are extremely flammable and explosive. Keep fuel away from smoking, open flames, sparks, pilot lights, heat, and other ignition sources.

## KNOWING YOUR GENERATOR

Use the illustrations below to become familiar with the locations and functions of the various components and controls of this generator.

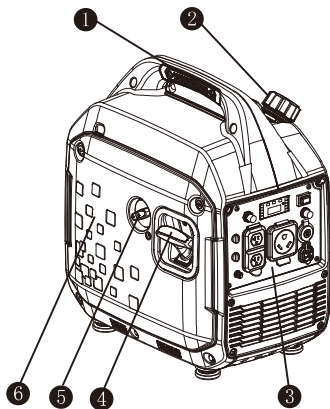

- ① Carrying handle
- ② Fuel tank cap
- ③ Control Panel
- ④ Recoil starter
- ⑤ Combination switch  
(CHOKE&RUN&OFF&STOP)

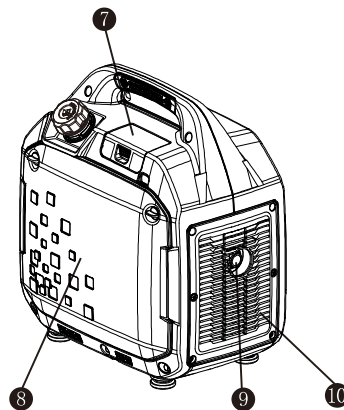

- ⑥ Left cover
- ⑦ Spark plug maintenance cover
- ⑧ Right cover
- ⑨ Muffler
- ⑩ Muffler blind window

### Control Panel

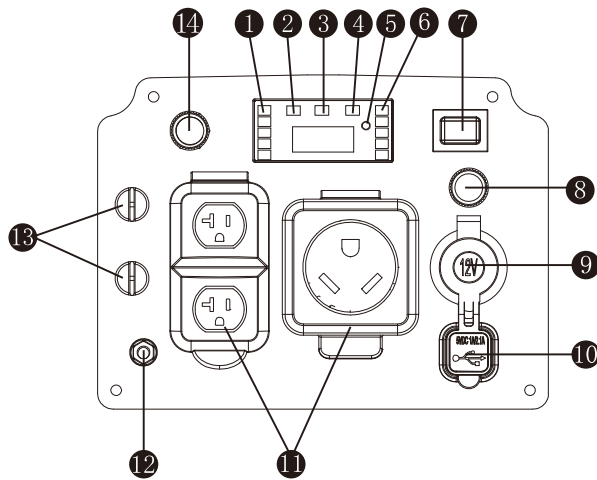

- ① Power indicator
- ② Overload indicator
- ③ Running indicator
- ④ Oil alarm lamp
- ⑤ Reset button
- ⑥ Fuel display
- ⑦ Energy-saving switch
- ⑧ DC breaker
- ⑨ 12V DC
- ⑩ USB port
- ⑪ AC output receptacle
- ⑫ Ground terminal
- ⑬ Parallel kit terminal
- ⑭ AC breaker

### Overload indicator (red)

When the overload indicator is on, it indicates that the generating set is overload and then the AC protector works. It will stop the output of generating set to protect the electric equipment and the generating set itself. At this time, the running indicator (green) is off and the overload indicator (red) is on, but the engine is still in running state.

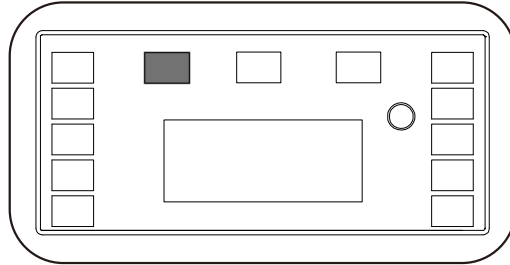

When the generating set has no output and the overload indicator is on, please take the following steps:

1. Lower the total power of the connected electric devices to the rated output range of generating set.
2. Check the air intake for impurities and check the control parts for abnormal situation. Handle immediately if necessary.
3. Press the reset button.

### Running indicator (green)

The running indicator lights up when generating set starts and has normal output.

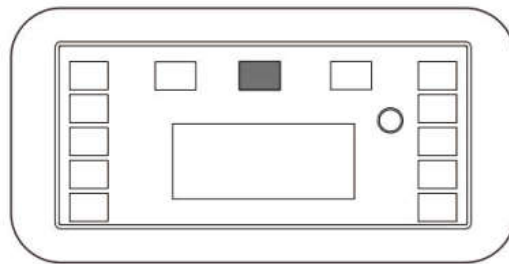

### Oil alarm lamp (yellow)

When the oil level drops below the lower limit, the oil protection system will stop the engine automatically and oil alarming lamp will blink by pulling the recoil starter. The engine will not run until the oil has been filled to the proper level.

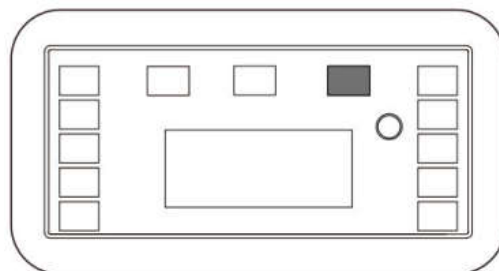

**Note:** If engine flames out or fails to start, turn the combination switch to “RUN” position and then pull the recoil starter. If the oil alarming lamp lights up, it shows lack of oil. Please add appropriate oil and restart the engine.

### Rest button

The reset button is used to restore output if an overload occurs. To restore output, reduce the loads and press the rest button.

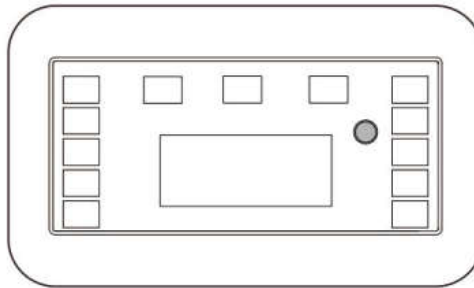

### Energy-saving switch

When the energy-saving switch is in “ON” position, the energy saving equipment controls the engine rotate speed according to the connected loads. There will be good fuel consumption and low noise. When the energy-saving switch is in “OFF” position, the engine will always run in rated rotate speed no matter it is connected to the loads or not.

**Note:** Please set the energy-saving switch to “OFF” position when connect to air compressor, sinking pump etc. because these equipments need large starting current.

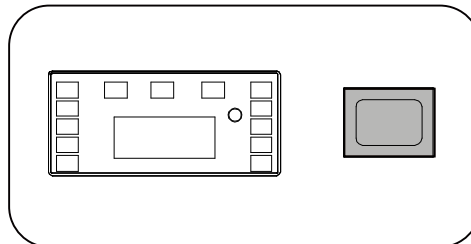

### Grounding terminal

The grounding terminal is designed to prevent electric shock by connecting it to the grounding wire. The generating set must be properly grounded before operation.

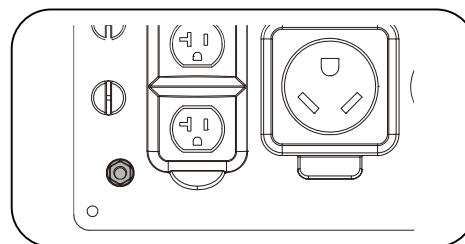

### Combination switch (CHOKE&RUN&OFF&STOP)

**Note:** One-button start and remote control start, no function of manually close for the choke.

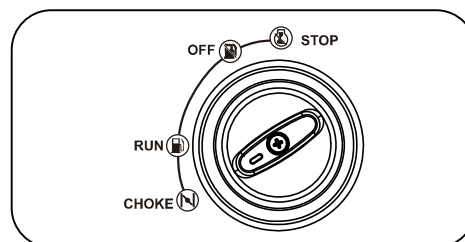

Choke: Close the choke.

Note: Turn to choke position to start when engine is cold, and turn to Run position to start when engine is hot.

Run: The generating set operates normally.

Off: Fuel off without stop. This position can run out of the remaining fuel and improve the reliability of the generating set.

Note: If you do not plan to use the generator in the near future, please use this function, or drain the fuel inside the carburetor through the carburetor drain bolt.

Stop: The stop position of the generator.

Note: After the generating set is unloaded, please run for 3 minutes at no load to stabilize the temperature, then stop the generating set.

### Circuit breaker

When the generator is overloaded or overheated for a long time, the thermal protector works.

Under protected, please reduce the load or run it for a few minutes without load. Press the thermal protector button, then output recovers.

**Note:** The thermal protector is influenced by factors, such as operation current and ambient temperature, so the protection time varies.

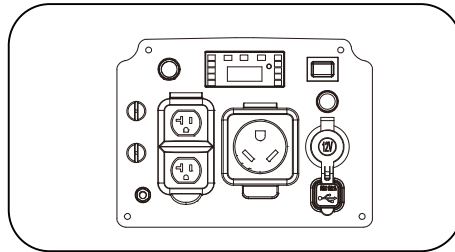

### Parallel kit terminal

It used for parallel operation with another inverter.

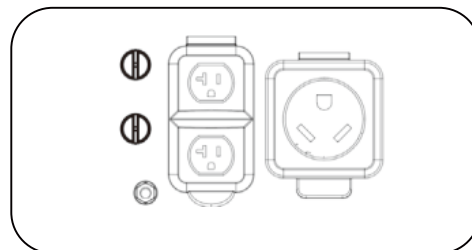

### Fuel tank cap

Remove the fuel tank cap by rotating it anticlockwise.

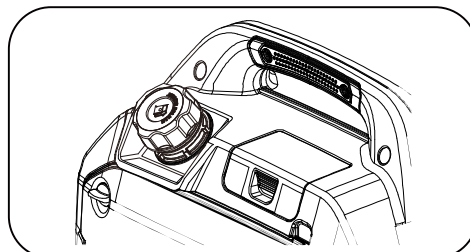



## **GENERATOR PREPARATION**

The following section describes steps necessary to prepare the generator for use. If after reading this section, you are unsure about how to perform any of the steps please call (800) 791-9458 Mon-Fri 9-5 EST for customer service. Failure to perform these steps properly can damage the generator or shorten its lifespan.

### **Unpacking**

Unpack the generator and all its parts. Do not discard the carton or any packaging until the generator is completely assembled.

### **1. Operating Location**

- Only use OUTSIDE and place the generating set in a well-ventilated area.
- Only operate the generating set on a flat, level surface and in a clean, dry operating environment.
- Allow two feet clearance on all side of the generating set while operating it outdoors.
- Operate in specified area, if any problem on applicable occasion, please consult the authorized local dealers. In some areas, generating set must be registered with the local utility. Generating set used to construction sites may be subject to additional rules and regulations.



**DANGER:** The exhaust of the generating set contains carbon monoxide, using engine indoors **CAN KILL YOU!** NEVER use inside any building or any kind of enclosure, EVEN IF doors and windows are open. Place the generating set in a well-ventilated and clean area. Note the wind direction and air current when place the generating set.

### **High altitude**

This generating set may require a high altitude carburetor kit to ensure correct operation at high altitudes. Consult the authorized local dealer for high altitude kit information if you always operate your engine at altitudes above 5,000 feet (1,500 meters).



**CAUTION:** Even with carburetor modification, generating set horsepower will decrease about 3.5% for each 1,000 feet (300 meters) increase in altitude. The effect of altitude on horsepower will be greater than this if no carburetor modification is made.

Operation the engine at altitude below 5,000 feet (1,500 meters) with modified carburetor may cause the generating set to overheat and result in serious engine damage. Please restore factory specifications of the carburetor at the dealer when using the engine in a low altitude area.

### **2. Operating Condition**

Check for loose or damaged parts, signs of oil or fuel leaks, and any other condition that may affect proper operation. Repair or replace all damaged or defective parts immediately.



**WARNING:** Failing to correct problem(s) before operation could result in property damage, serious injury or DEATH.

Clean the dirt or foreign objects on the surface around exhaust and air intake of generator. DO NOT move or tip the generating set during operation. Use generating set only for intended uses. If you have questions about intended use, ask your local dealer.



### 3. Engine oil check



**WARNING:** This engine is not filled with oil before send out to the factory. User must add the proper amount of oil before operating the generator for the first time. Any attempt to crank or start the engine before it has been properly filled with the recommended type and amount of oil may result in engine damage and void your warranty.

The oil capacity (rated) of the engine crankcase is 19.6 fl. oz.

#### ENGINE OIL RECOMMENDATIONS

Only use 4-stroke engine oil of SJ,SL or equivalent level which are in accordance with or higher than API standard.

Check the API label on oil bottle or other container, and make sure the “SJ,SL” or equivalent level letter is in the label.

SAE 10W-30 is recommended for general, all-temperature use. Other viscosities shown in the chart may be used when the average temperature in your area is within the indicated range.

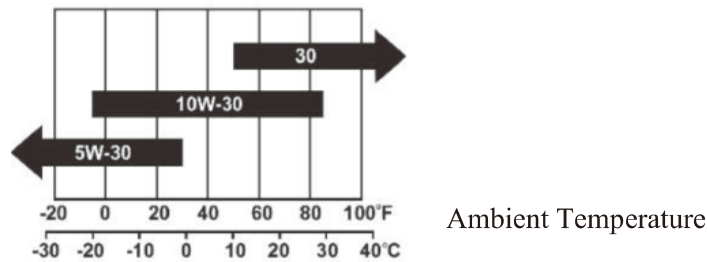

- Place the engine on a level surface with engine stopped. Check the engine oil level. Remove the oil maintenance cover. Remove the dipstick and wipe it clean.

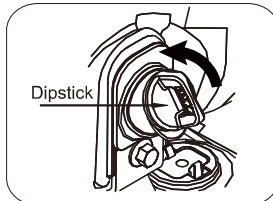
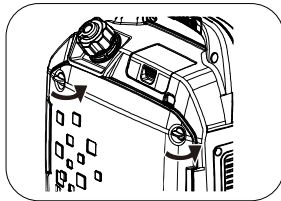

- Reinstall dipstick into hole, rest on oil fill neck, DO NOT thread cap into hole.
- Remove the dipstick again and check oil level. Level should be between the upper and lower limit.
- Fill to the upper limit of the dipstick with the recommended oil if the oil level is too low.

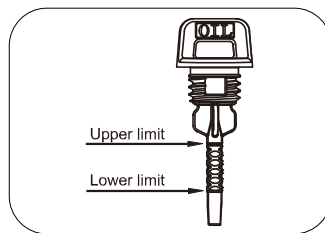
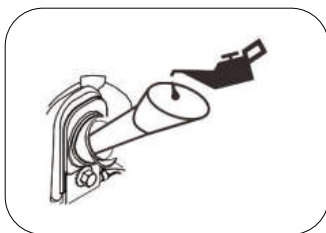

- Reinstall and fully tighten the dipstick.

**CAUTION:** Operate generator only on a level surfaces. The engine is equipped with a low oil sensor (applicable types) that will automatic stop the engine when the oil level falls below the safe limit. To avoid the inconvenient of an unexpected shutdown, fill to the upper limit and check the oil level regularly.

#### 4. Generating set fuel check



**WARNING:** This generator may emit highly flammable and explosive gasoline vapors, which can cause severe burns or even death if ignited. A nearby open flame can lead to explosion even if not directly in contact with gasoline.

With the engine stopped, check the fuel level. Refill the fuel tank if necessary. Use clean, fresh, regular unleaded gasoline with a minimum octane rating of 87. Do not mix oil with gasoline. Always wipe up any spilled fuel.

#### To add gasoline, follow these steps:

1. Make sure the generator stopped and it is on a level surface.
2. Unscrew fuel cap and set aside.  
**NOTE:** The fuel cap may be tight and hard to unscrew.
3. Slowly add unleaded gasoline to the fuel tank. Be sure not to fill above the upper limit mark. Always allow room for fuel expansion. The capacity of the fuel tank is 1.53 gallons .  
**NOTE:** Do not fill the fuel tank to the very top. Gasoline will expand and spill over during use even with the fuel cap in place.
4. Reinstall fuel cap and wipe clean any spilled gasoline with a dry cloth.

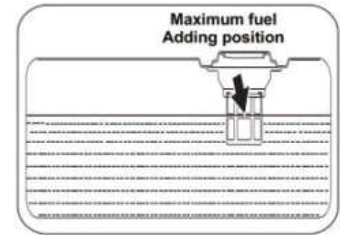

#### IMPORTANT:

- Do not fill tank indoors.
- Do not fill tank when the engine is running or hot.
- Never use an oil/gasoline mixture.
- Never use old gasoline.
- Avoid getting dirt or water into the fuel tank.
- Gasoline can age in the tank and make starting difficult. Never store generator for extended periods of time with fuel in the tank or the carburetor.
- Turn the fuel cock off and drain the fuel from the carburetor.



#### CAUTION:

- Never use engine or carburetor cleaner products in the fuel tank or permanent damage may occur.
- It is important to prevent gum deposits from forming in essential fuel system parts, such as the carburetor, fuel filter, fuel hose or tank during storage. Also, experience indicates that alcohol-blended fuels (called gasohol, ethanol or methanol) can attract moisture, which leads to separation and formation of acids during storage. Acidic fuel can damage the fuel system of the generating set while in storage. Be sure to review the instruction given in “Storage” section.
- Gasoline/ Alcohol Blends: up to 10% alcohol, 90% unleaded gasoline by volume is approved as a fuel. Other gasoline/alcohol blends are not approved.
- Effects of old, stale or contaminated fuel are not warrantable.
- Allow the generating set to cool for at least two minutes before removing fuel cap when adding fuel. Loose the fuel cap slowly to relieve any pressure in the tank.

## 5. Generating set grounding



**DANGER:** Failure to properly ground the generator can result in electrocution.

The generator must be properly connected to an appropriate ground. It helps prevent electrical shock if a ground fault condition exists in the generating set or in connected electrical devices, especially when the unit is equipped with a wheel kit. Proper grounding also helps dissipate static electricity, which often builds up in ungrounded devices.

A ground terminal has been provided on the generating set. For remote grounding, connect a length of heavy gauge (4mm<sup>2</sup>) copper wire between the generating set ground terminal and a copper rod driven into the ground.

Local electrical codes may also require proper grounding of the unit. We strongly recommend that you consult with a qualified electrician for grounding requirements in your area.

### ELECTRICAL DEVICES

Disconnect all electrical devices from the generator and switch off the AC circuit breaker before start the engine.

The generator may be hard to start with electrical devices.

The connected electrical equipment must not exceed the maximum limit of the generator. Please refer to the specification table for details.

**NOTE:** After completing the above preparation, the generator is ready to be started.

### STARTING THE GENERATOR



**CAUTION:** Disconnect all electrical loads from the generator before attempting to start.

Pull the starter handle 6-8 times to prefill fuel system before initial operation or removal from long term storage. Failure to do so could result in bad starting experience.

1. Perform generator preparation (see page 12) and remove all loads.
2. Cold start  
Turn the combination switch to “CHOKE” position to shut off the choke.  
Warm start  
Turn the combination switch to “RUN” position, if not started, please turn the combination switch to “CHOKE” position before restarting.

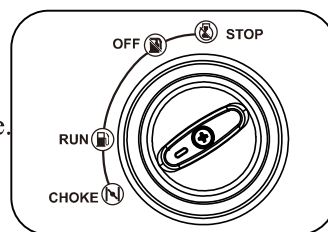

3. Turn the energy saving switch to the “ON” position.  
Note: When the energy-saving switch is in “ON” position, the energy saving equipment controls the engine rotate speed according to the connected loads. There will be good fuel consumption and low noise. When the energy-saving switch is in “OFF” position, the engine will always run in rotate speed no matter it is connected to the loads or not. Please set the energy-saving switch to “OFF” position when the load is over 1200W.

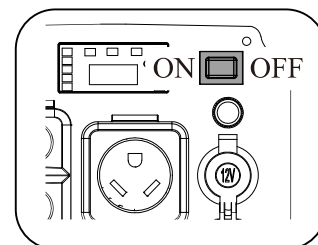

#### 4. Manual start



**WARNING:** Check starter cord conditions before operating. Have it replaced immediately by local authorized dealer if cord is frayed.

- When starting engine, grasp the recoil starter handle and pull slowly until resistance is felt. Then pull rapidly to avoid kickback. When pulling the recoil starter, firmly grasp the carrying handle to avoid tumble of generating set.

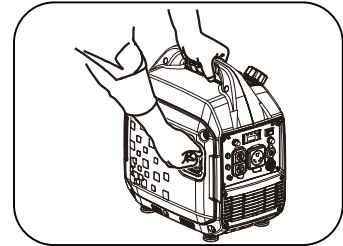

#### **WARNING: KICKBACK**

Rapid retraction of the starter cord will pull hand and arm towards the engine faster than you can let go.

Unintentional startup can result in entanglement, traumatic amputation or laceration. Broken bones, fractures, bruises or sprains could result.

- Turn the combination switch to “RUN” position.
- When electrical device requires a large starting current, please put the energy-saving switch in the “OFF” position. When the starting current required by electrical device is small, put the energy-saving switch in the “ON” position.
- After all above operations, the engine can be normally loaded.

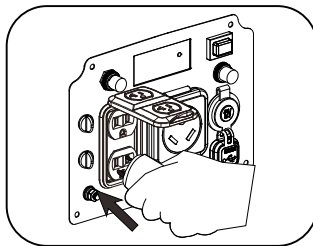
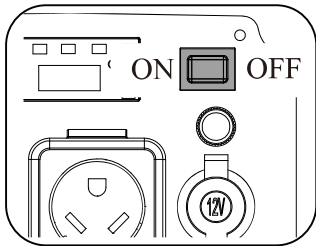
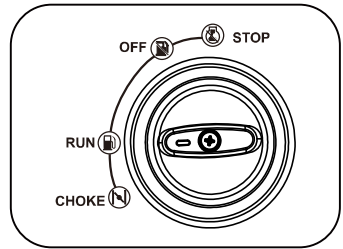

### **USING THE GENERATOR**



**WARNING:** It is prohibited to start or close the generating set when the output terminal of generating set is connected to an electric device is in “ON” state.

#### **CONNECT TO ELECTRICAL DEVICES**

1. Inspect power cord for damage before using. There is a hazard of electrical shock from crushing, cutting or heat damage.
2. Make sure that the generating set has been properly grounded. If the electric devices require grounding, the generating set must ground.
3. Make sure that the electric devices are in “OFF” position.
4. Allow the engine to stabilize and warm up for a few minutes after starting.
5. Connect and start the electric devices.
6. Turn off all electric devices and disconnect them from the generating set.
7. If the generating set supplies for several loads or electric devices, start the smallest one first and the largest one last.



**DANGER:** If connected devices overheat, turn them off and disconnect them from generating set.

## Electrical Shock

To reduce the risk of electrical shock, DO NOT use electrical cords that are worn, frayed, bare or otherwise damaged. DO NOT touch bare wires or receptacles. DO NOT handle generating set or electrical cords while standing in water, while barefoot, or while hands or feet are wet.

### LOADING CAPACITY



**WARNING:** Do not overload the generating set. Exceeding the generating set's capacity can damage the generating set and/or electric devices connected to it.

You must make sure your generating set can supply enough rated (running) and (starting) watts for the electrical devices at the same time. Follow these simple steps to calculate the running and starting watts necessary for your purposes.

1. Count the electrical devices you will power at the same time.
2. The amount of power you need to run with the devices is the total rated (running) watts of these items.
3. Starting power is the power needed shortly when electric devices start. Since not all devices start at the same time, starting power can be estimated by the maximum power of all devices plus the total power counted in step 2.

Electric equipment		Rate power(W)	Starting power(W)
Appliances	Tablet computer 27"	80	100
	Energy saving lamp	5-50	5-50
	Electric cooker	1000	1000
	Computer	250	250
	Electric fan	50	100
	Washing machine	250	500
	Refrigerator	50	300
	Air-conditioner	1600	3200
Electric tooling	Electric hammer	1000	1500
	Impact Hammer	3000	6000
	Water pump	2200	5000
	Electric welding machine	5000	7500
	Air compressor	5000	10000

**Wattage Reference Chart**



**WARNING:** It is necessary to equip with circuit protector or switch to isolate the generating set from the electric utility when the generating set is mainly used for backup. Failure to isolate the generating set from the power utility may result in injury or death to electric utility workers and damage to the generating set due to back feed of electrical energy.

### PARALLEL OPERATION

Make sure that the generating set is in a good running state before connecting it to other generating sets. The total power of electric devices should not exceed rated power of generating set.

When electric motor starts, the overload indicator (red) will light up and normally it will stop within 4 seconds. If it cannot stop, please call (800) 791-9458 Mon-Fri 9-5 EST or email: support@amerisuninc.com for customer service.

During parallel operation, energy-saving switches of generating sets should be in the same position. To parallel operation, perform the following steps:

1. Connect one generating set to other generating set(s) in parallel. Use the parallel kit to make the parallel connection (the parallel kit needs to be purchased separately).
2. Insert the plug of the parallel kit into the parallel socket on the panel, and start the generators in turn. Make sure that the output indicator of each generator is in normal state (green).
3. Connect the plug of electric devices to the AC receptacle of parallel kit.

**NOTE:** When connecting, please connect the plug to the panel socket of the same color.

4. Run the electric devices.



**CAUTION:** When overload too much, overload indicator (red) blinks continuously, and the generating set may be damaged. When overload a little, overload indicator (red) lights up continuously, it may shorten the service life of generating set. When continuously operating the generating set, power cannot exceed the rated power of generating set. The total power of electric devices cannot exceed the rated power of generating set. The manufacturers of electric devices or tools always list the rated power of similar models or serial number.

## STOPPING THE GENERATOR



**WARNING:** Never stop the engine with electrical devices connected and with the connected devices turn “ON”.

1. Remove the connectors of all electric equipment from the generating set panel.

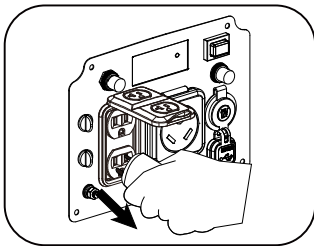

2. Turn the combination switch to “STOP” position, the generator stops operation.

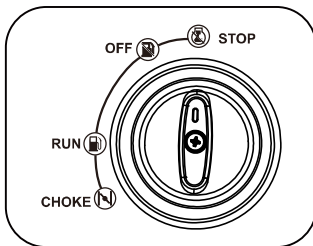

## MAINTENANCE

It is the operator’s responsibility to complete all scheduled maintenance in a timely manner. Correct any issue before operating the generating set. Always follow the inspection and maintenance recommendations and schedules in this manual.



**WARNING:** Improper maintenance or failure correct a problem before operation can cause a malfunction and result in property damage, serious injury or DEATH. Improper maintenance will void your warranty.



**DANGER:** Accidental starts can cause severe injury or death. Remove the spark plug cap and ground generating set before performing any service.



**WARNING:** The filter element may contains PAHs, PAHs are harmful for your health. Please wear gloves for protection during air filter maintenance.



## MAINTENANCE SCHEDULE

Stop the generating set before serving, disconnect all electric devices and battery (If equipped),and cool down the generating set completely.

Serve the generating set in a clean, dry and flat area, so that no accident would happen during the serving.

Please make the wheel in brake state to stop accidental movement of generating set.

Follow the service intervals indicated in the chart below. Service your generating set more frequently when operating in adverse conditions.

Contact your local authorized service dealer for your generating set or engine maintenance needs.

		Each time before use	The first month or 10 hours <small>note2</small>	Every three months or 50 hours <small>note2</small>	Every six months or 100 hours <small>note2</small>	Every year or 300 hours <small>note2</small>
Engine oil	Inspection	√				
	Replacement		√		√	
Air filter	Inspection	√				
	Cleaning			√ <small>note3</small>		
Spark plug	Inspection and adjustment				√	
	Replacement					√
Spark Extinguisher <sup>note1</sup>	Cleaning				√	
Idle speed	Inspection and adjustment					√ <small>note4</small>
Valve clearance	Inspection and adjustment					√ <small>note4</small>
Carbon canister <small>note1</small>	Inspection	Ever two years <small>note4</small>				
Low permeability Oil tube <small>note1</small>	Inspection	Ever two years <small>note4</small>				
Oil tube	Inspection	Ever two years <small>note4</small>				

### NOTE:

Note1: Applicable types (if available).

Note2: Before each season and after then (whichever comes first).

Note3: Service more frequently under severe , dusty, dirty conditions.

Note4: To be performed by knowledgeable, experienced owners or the authorized dealer.

## GENERATING SET MAINTENANCE



**WARNING:** Never clean the generator when it is running! Never use water to clean the generating set. Water can enter the generating set through the cooling slots and damage the generating set windings.



**WARNING:** Do not modify the generator in any way. Do not tamper with governed speed. Generator supplies correct rated frequency and voltage when running at factory set. Tampering with the factory set governor will void your warranty.

- Make certain that the generator is kept clean and stored properly.
- Use a damp cloth to clean exterior surfaces of the generating set. Use a soft brush to clean the dirt and oil.
- Use an air compressor (25 PSI) to clear dirt and debris from the generating set.
- Inspect all air vents and cooling slots to ensure that they are clean and unobstructed.

## ENGINE MAINTENANCE

### Changing the oil



**WARNING:** Change the oil when the engine is warm from operation. The oil can reach up to 140°C under that condition. Careful operation should be taken to prevent burns.

1. Place the machine on a level surface which is 300mm higher than the ground.
2. Remove the right cover.

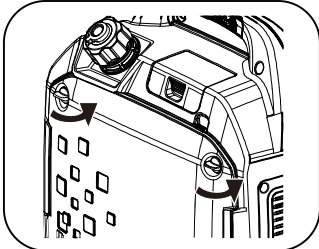

3. Place the waste oil box on the ground.
4. Remove the oil dipstick, and tilt the machine to pour the oil.
5. Add recommended oil to the upper limit.
6. Fully tighten the dipstick.
7. Properly dispose of any used oil at an approved waste management facility.
8. Reinstall the oil maintenance cover.



## AIR FILTER



**WARNING:** Do not run the engine without the air filter, or serious danger can result.

Routine maintenance of the air cleaner helps maintain proper airflow to the carburetor. Occasionally check that the air cleaner is free of excessive dirt.

1. Remove the air filter maintenance cover.
2. Loosen the filter fix clamp and remove the cover of the air filter.
3. Remove the foam filter element.
4. Wash in liquid detergent and warm water.
5. Squeeze thoroughly dry in a clean cloth.
6. Saturate in clean engine oil.
7. Squeeze in a clean, absorbent cloth to remove all excess oil.
8. Assemble the filter element onto the filter unit.
9. Assemble the filter fix clamp.
10. Reinstall the air filter maintenance cover.

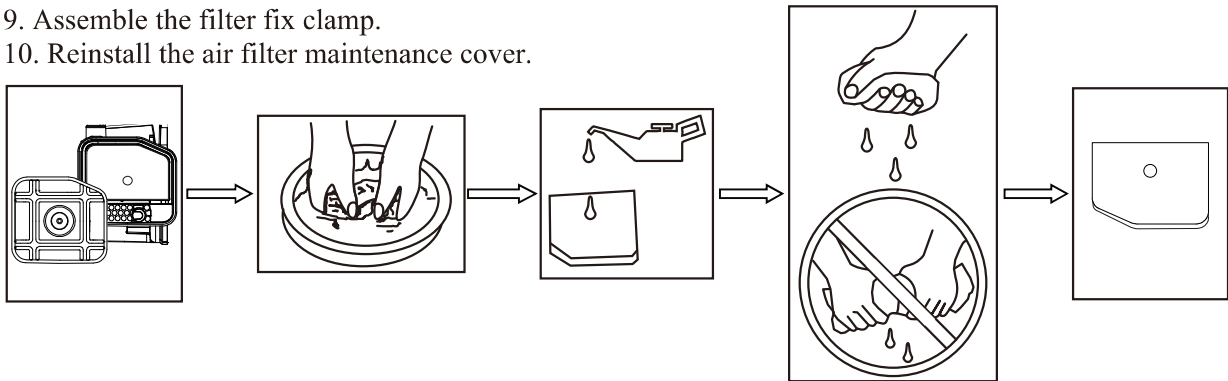

## SPARK PLUG

**Spark plug gap : 0.6mm-0.8mm(0.024-0.031 in). Spark plug tighten torque: 15-20N.m**

The spark plug is important for proper engine operation. A good spark plug should be intact, free of deposits, and properly gapped. Refer to Recommended Maintenance Schedule. To inspect the spark plug:

1. Clean any dirt from the spark plug cap and spark plug base.
2. Remove the spark plug cap.
3. Using socket wrench to loose and remove the spark plug.
4. Inspect the spark plug and spark plug washer, if it was broken or worn, replace with a new one. Clean the spark plug with wire brush if reuse it.
5. Check spark plug gap. Carefully bend side electrode to adjust the gap if necessary.
6. Carefully thread the plug into the engine by hand.
7. After the spark plug is seated, use spark plug wrench to tighten the plug.
8. Attach the spark cap to the plug and connect the spark plug wire to the plug.

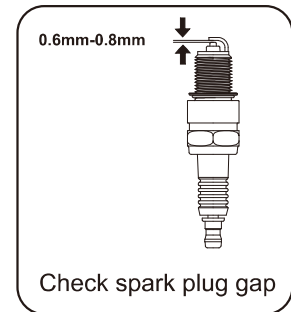

**CAUTION:** Only use recommended spark plug or equivalent. Do not use spark plugs that have improper heat range.

## SPARK ARRESTER

1. Allow the generating set to cool completely before servicing the spark arrester.
2. Remove the muffler blind window first.
3. Remove the spark arrester screen.
4. Carefully remove the carbon deposits from the spark arrester screen with a wire brush.
5. Replace the spark arrester if it is damaged.
6. Reinstall the spark arrester in the muffler and reinstall the muffler blind window.

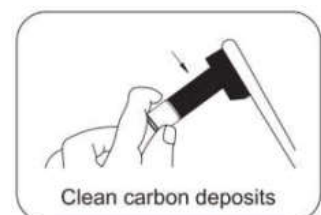

## **STORAGE & TRANSPORT PROCEDURES**

### **STORAGE**



**WARNING:** Gasoline is highly flammable and extremely explosive. Empty the fuel tank and shut off fuel valve before storing or transporting this generating set.

The generating set should be started at least once every 2 weeks and allowed to run for at least 20 minutes. Follow the instructions below for longer term storage if the generating set will be out of service for 2 months or more.

- Allow the generating set to cool completely before storage.
- Clean the generating set according to instruction in maintenance section.
- Drain all fuel completely from the fuel tank, fuel hose and carburetor to prevent gum from forming.
- Turn off the fuel supply at the fuel valve.
- Change the oil.
- Reattach the spark plug.
- Remove the spark plug and pour about 15ml of oil into the cylinder. Crank the engine slowly to distribute the oil and lubricate the cylinder.
- Store the unit in a clean, dry area out of direct sunlight.

### **TRANSPORT**

To prevent fuel spillage when transporting or during temporary storage, the generating set should be secured upright in its normal operating position, with the engine switch OFF. The combination switch should be in the “stop” position and knob of the fuel cap should be turned to the “OFF” position.

#### **When transporting:**

- Do not overfill the tank.
- Do not operate the generating set while it is on vehicle. Take the generating set off the vehicle and use it in a well-ventilated place. Avoid a place exposed to direct sunlight when putting the generating set on a vehicle. If the generating set is left in an enclosed vehicle for many hours, high temperature inside the vehicle could cause fuel to vaporize resulting in a possible explosion.
- Do not drive on a rough road for an extended period with the generating set on a rough road, drain the fuel from the generating set beforehand.

## TROUBLESHOOTING

Failure	Trouble	Solution
Generating set fails to start	Combination switch is in "OFF" or "STOP" position.	When engine is cold, turn switch to "CHOKE", and follow starting procedure to start the generating set. When engine is hot, turn switch to "RUN", and follow starting procedure to start the generating set,
	Lack of fuel.	Fill fuel tank per instructions in this manual.
	Lack of engine oil.	Check oil level. This engine is equipped with a low oil sensor. The engine cannot be started unless the oil level is above the prescribed lower limit.
	No ignition.	Remove the spark plug cap. Clean any dirt around the plug base, and then remove the spark plug. Install the spark plug in the plug cap. Turn the combination switch to "RUN" position. Grounding the electrode to any engine ground, pull the recoil starter to see if sparks jump across the gap. If there is no spark, replace the plug.  Reinstall the plug and start engine according to instructions in this manual.  Consult Customer Service if necessary.
	Spark plug is splashed by fuel	Remove the spark plug and wipe the fuel.
	The generating set flames out after running for a certain time.	Turn the ventilation knob on the fuel tank cap to "ON" position;  Check the fuel and oil level. Add them if necessary.
	Battery undercharge (electric start)	Charge the battery by starting the generator manually (at least 30 minutes). After closing the choke manually, start the generator according to the manual startup steps.
Generating set has no output	Breaker trip	Reset circuit breakers.
	Inadequate cord sets or extension cords.	Check cord sets or extension cords capabilities in section controls; cable size in this manual.  Consult Customer Service if necessary.

# WIRING DIAGRAM

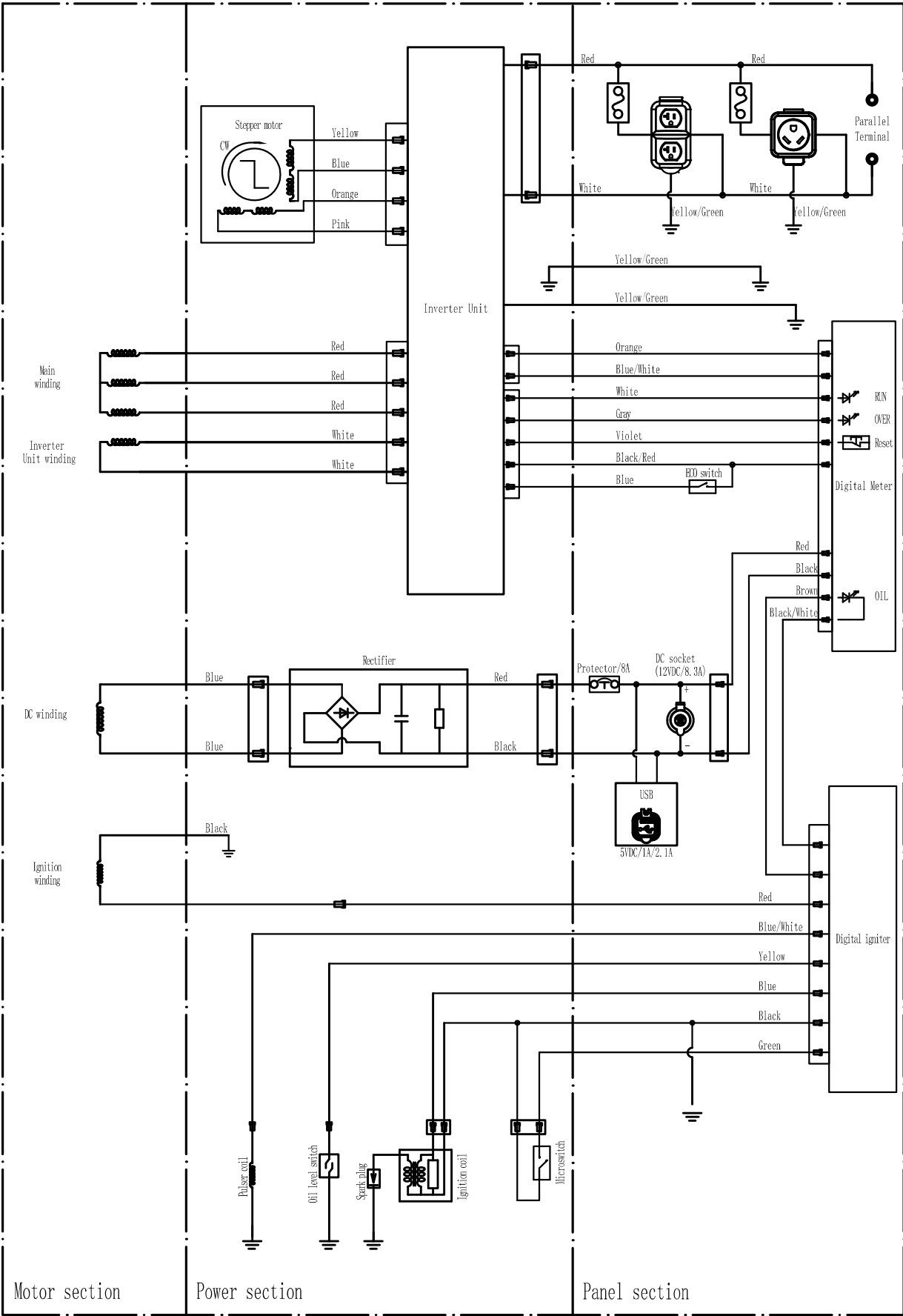

# EXPLODED VIEW & PARTS LIST

## Generator exploded view

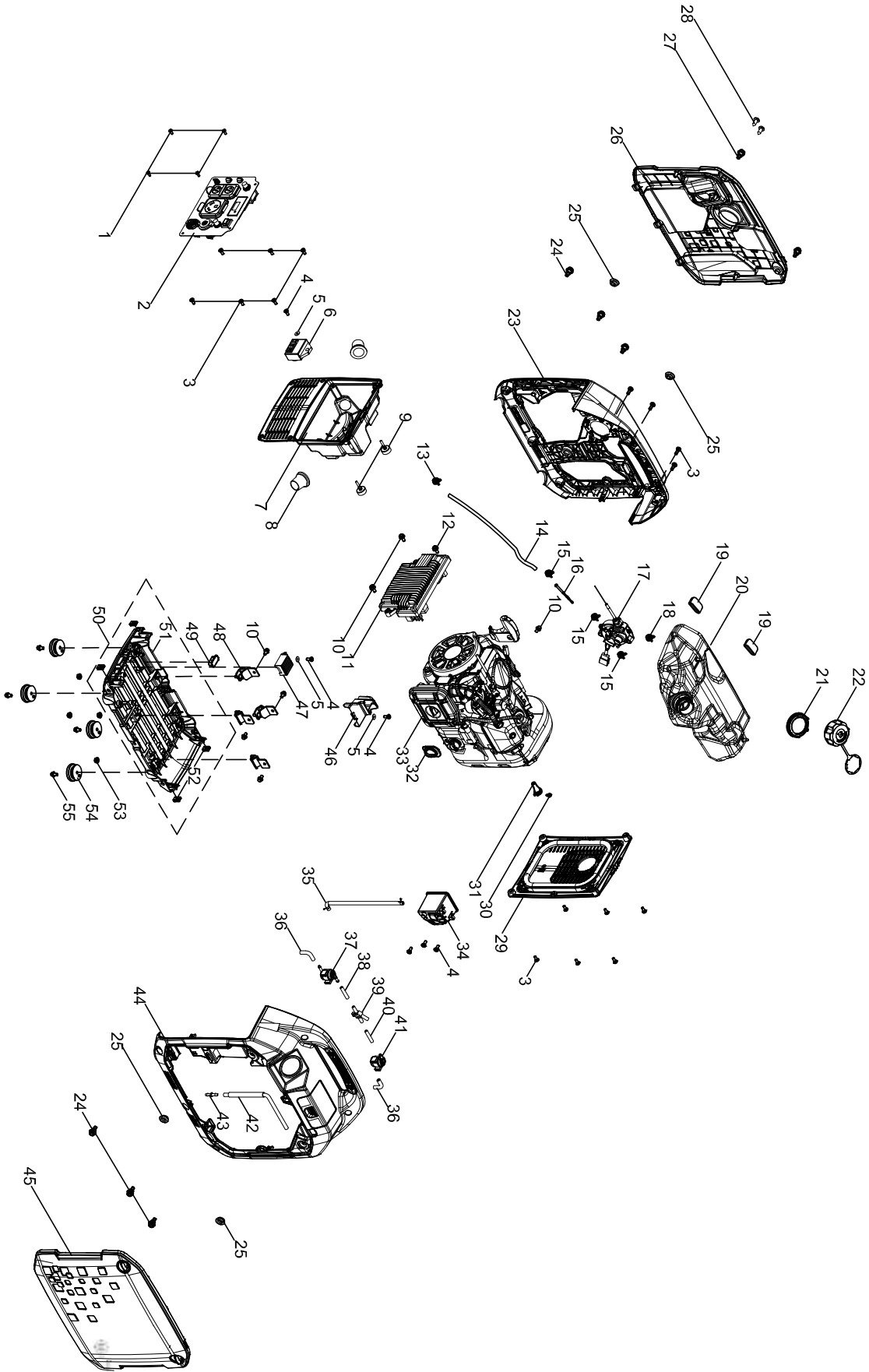

## Generator parts list

Part#	Stock#	Description	Qty.
1	100010946-0001	Screw, M4×10	4
2	100727215-0001	Control Panel	1
3	100033079-0003	Screw, M5×16	19
4	100011002-0004	Self-tappling Screw, ST4.2×19	6
5	100010897-0001	Washer, φ4	3
6	100087971	Ignition Module	1
7	100716667	Left Hull	1
8	100711831	Wire Jacket	2
9	100716670	Bumper pad	2
10	100011570-0001	Bolt, M6×12	7
11	100711015	Inverter	1
12	100011247-0004	Bolt, M5×8	1
13	100005130	Clamp	1
14	100716682	Fuel Hose	1
15	100005148	Clamp	3
16	100711177	Fuel Filter	1
17	100716675	Switch Assembly	1
18	100005135	Clamp	1
19	100072727	Damping Pad	2
20	100716694	Fuel Tank	1
21	100008887	Nut	1
22	100008761	Fuel Cap	1
23	100727374-0001	Left Hull Assembly	1
24	100081994	Alignment Bolt	6
25	100716674	Damping Pad	4
26	100727376-0002	Left Cover Board Assembly	1
27	100072713-0002	Phillips Bolt	2
28	100011006-0004	Self-tappling Screw, ST4.8×13	2
29	100727377-0001	Service Window Assembly	1
30	100011000-0001	Self-tappling Screw, ST4.2×9.5	1
31	100085794	Spark Arrester	1
32	100072878-0001	O-Ring, Dipstick	1
33	1ZZDDF331	Engine	1
34	100158093	Carbon Canister	1
35	100716686	Fuel Hose	1
36	100161875-0001	Fuel Hose	2
37	100158094	Roll Over Valve	1
38	100716692	Fuel Hose	1
39	100160310	Fuel Tee Pipe	1
40	100716690	Fuel Hose	1
41	100158092	Roll Over Valve	1
42	100716688	Fuel Hose	1
43	100731971	Fuel Tee Pipe	1
44	100727373-0001	Right Hull Assembly	1
45	100727375-0002	Right Cover Board Assembly	1
46	100717737	Shroud Cover	1
47	100137683	Rectifier	1
48	100072715	Damping Pad	4
49	100072710	Damping Pad	1
50	100716663	Switch Box Base	1
51	100716665	Switch Box Base Body	1
52	100050562	Fuel Tank Mount Thread Tab	4
53	100011452-0003	Nut, M6	4
54	100072712	Rubber Cap	4
55	100011261-0004	Bolt, M6×12	4

# Engine exploded view

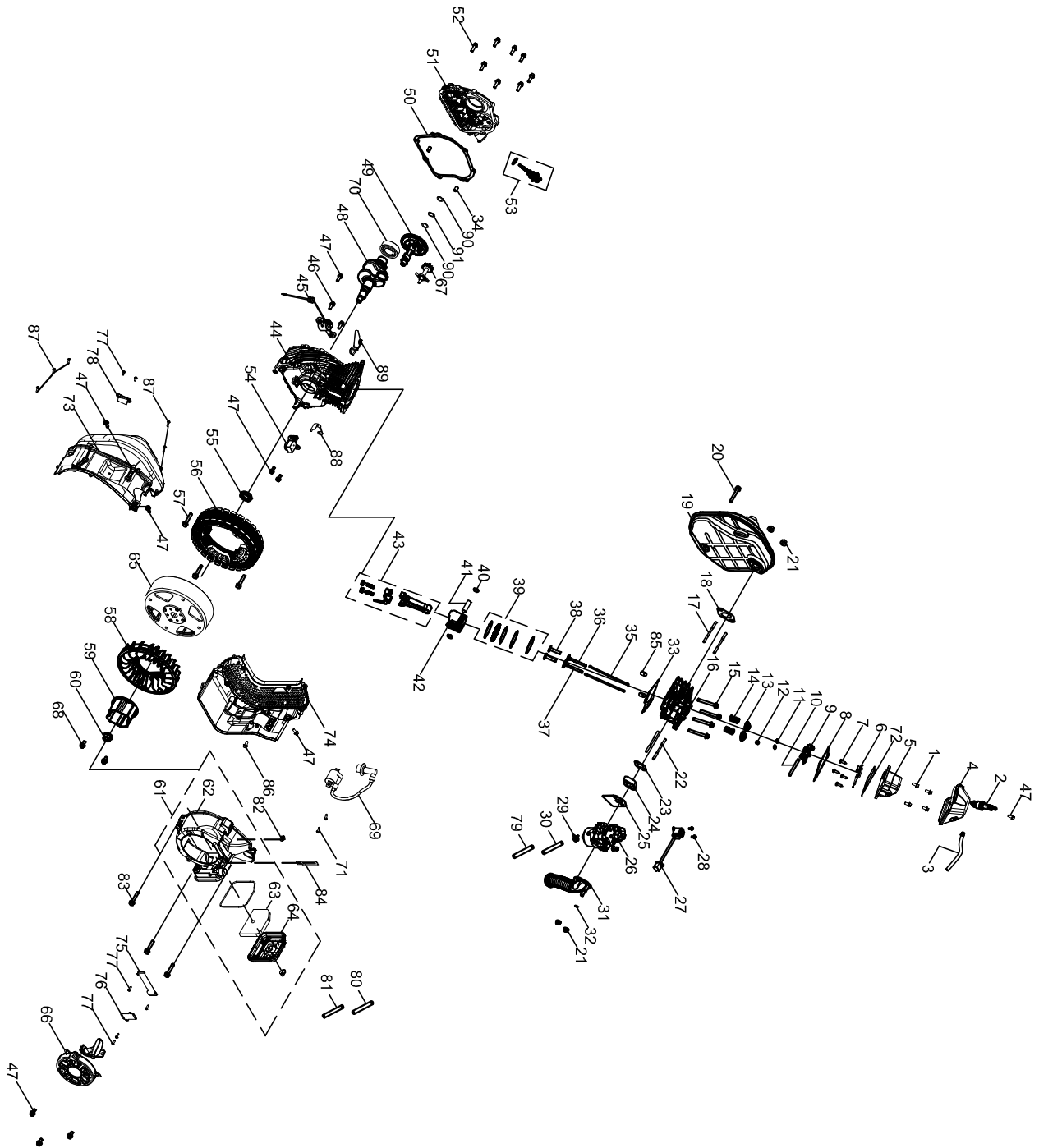

## Engine parts list

Part#	Stock#	Description	Qty.
1	100031968-0002	Bolt, M6×20	4
2	100009386	Spark Plug	1
3	100088413	Breather Hose	1
4	100158098	Valve Cover	1
5	100157081	Valve Cover Assembly	1
6	100158112	Inner Cover, Valve Cover	1
7	100005133	Screw, M3×6	4
8	100158122	Gasket, Valve Cover	1
9	100158128	Rocker Arm Assembly	2
10	100158127	Rocker Arm Coreshaft	1
11	100075055	Valve Locker	2
12	100075058	Intake Valve Seal	1
13	100075056	Valve Spring Seat	2
14	100158126	Valve Spring	2
15	100002464-0001	Bolt, M8×60	4
16	100157089	Cylinder Head	1
17	100051258-0001	Stud, M6×82	2
18	100075043	Gasket, Muffler	1
19	100158113	Muffler	1
20	100011280-0002	Bolt, M6×75	1
21	100011452-0003	Nut, M6	4
22	100010348	Stud, M6×87	2
23	100158108	Gasket, Carburetor Insulator	1
24	100158118	Insulator	1
25	100158117	Gasket, Carburetor	1
26	100716704	Carburetor	1
27	100061512	Stepping Motor	1
28	100051029-0002	Screw, M4×6	2
29	100090871	Clamp	1
30	100714183	Fuel Hose	1
31	100158121	Intake Manifold	1
32	100005150	Clamp	1
33	100158124	Gasket, Cylinder Head	1
34	100010549	Pin, φ8×12	2
35	100158123	Push Rod	2
36	100158115	Exhaust Valve	1
37	100158002	Intake Valve	1
38	100004262	Tappet	2
39	100725589	Piston Ring Set	1
40	100003220	Circlip	2
41	100722061	Piston Pin	1
42	100717667	Piston	1
43	100157084	Connecting Rod Assembly	1
44	100157087	Crankcase	1
45	100719270-0001	Oil Sensor	1
46	100031967-0007	Bolt, M6×16	2
47	100011570-0001	Bolt, M6×12	11
48	100158116	Crankshaft	1
49	100158125	Camshaft	1
50	100158110	Gasket, Cylinder Cover	1
51	100157091	Crankcase Cover	1
52	100033100-0005	Bolt, M6×25	8



Part#	Stock#	Description	Qty.
53	100084322-0001	Dipstick	1
54	100162244	Trigger	1
55	100017644	Oil Seal, $\phi 25 \times \phi 41.25 \times 6$	1
56	100159878	Stator Assembly	1
57	100076844-0001	Bolt, M6×38	3
58	100158114	Cooling Fan	1
59	100157090	Starter Cup	1
60	100011462-0001	Nut, M14×1.5	1
61	100158109	Recoil Starter	1
62	100158181	Blower Housing	1
63	100158179	Air Filter Element	1
64	100158178	Air Filter Cover	1
65	100159877	Rotor	1
66	100145808	Recoil Starter	1
67	100724647	Oil Thrower Gear	1
68	100011571-0001	Bolt, M6×14	2
69	100710068	Ignition Coil	1
70	100072204	Bearing, 6205E	1
71	100093250-0004	Self-tappling Screw, ST4.8×20	2
72	100158111	Gasket, Cylinder Cover	1
73	100158103	Cylinder Head Baffle	1
74	100158107	Cylinder Head Baffle	1
75	100158097	Clip Base	1
76	100158096	Clip Base	1
77	100032967-0002	Self-tappling Screw, ST4.2×16	6
78	100158099	Idle Spring	1
79	100131884	Fuel Hose Jacket	1
80	100724658	Fuel Hose Body	1
81	100098589	Fuel Hose Jacket	1
82	100000672	Clip	1
83	100011274-0002	Bolt, M6×45	3
84	100000656	Clip	1
85	100010558	Pin, $\phi 10 \times 16$	2
86	100715178-0001	Bolt, M6×45	1
87	100011004-0001	Self-tappling Screw, ST4.2×25	5
88	100720770	Wind Board	1
89	100720769	Wind Board	1
90	100158680	Washer, $\phi 14.2 \times 0.5 \times \phi 21$	2
91	100162210	Corrugated Gasket	1

## **THREE (3) YEARS LIMITED WARRANTY**

PowerSmart is committed to building equipment that will provide years of dependable service. Our warranties are consistent with our commitment and dedication to quality.

### THREE (3) YEARS LIMITED WARRANTY OF POWER SMART PRODUCTS FOR HOME USE.

PowerSmart ("Seller") warrants to the original purchaser only, that all PowerSmart consumer power tools will be free from defects in material or workmanship for a period of three (3) years from date of purchase. If the tool(s) is used while providing professional or commercial services, the warranty coverage shall be for a maximum of (90) days.

SELLER'S SOLE OBLIGATION AND YOUR EXCLUSIVE REMEDY under this Three (3) Years Limited Warranty and, to the extent permitted by law, any warranty or condition implied by law, shall be the repair or replacement of parts, without charge, which are defective in material or workmanship and which have not been misused, carelessly handled, or improperly repaired, by person(s) other than an Authorized Seller or Service Center.

Please be aware that normal wear parts are not covered this warranty. This includes drive belts, blades and grass bags. Carburetor issues, and/or other damage found to be the result of stale, contaminated or compromised fuel, are not covered under this limited warranty.

To make a claim under this Limited Warranty, you must return the entire power tool product; transportation prepaid, to PowerSmart. The owner must include a legible copy of the original receipt, which shall list the date of purchase, along with the company's name where the product was purchased.

THIS LIMITED WARRANTY DOES NOT APPLY TO ANY ACCESSORY ITEMS INCLUDED WITH THE TOOL SUCH AS CIRCULAR SAW BLADES OTHER RELATED ITEMS OR TO ANY REPLACEMENT PARTS LISTED UNDER MAINTENANCE.

ANY IMPLIED WARRANTIES SHALL BE LIMITED IN DURATION TO THREE(3) YEARS FROM DATE OF PURCHASE. SOME STATES IN THE U.S. AND SOME CANADIAN PROVINCES DO NOT ALLOW LIMITATIONS ON HOW LONG AN IMPLIED WARRANTY LASTS, SO THE ABOVE LIMITATION MAY NOT APPLY TO YOU.

IN NO EVENT SHALL SELLER BE LIABLE FOR ANY INCIDENTAL OR CONSEQUENTIAL DAMAGES (INCLUDING BUT NOT LIMITED TO LIABILITY FOR LOSS OF PROFITS) ARISING FROM THE SALE OR USE OF THIS PRODUCT. SOME STATES IN THE U.S. AND SOME CANADIAN PROVINCES DO NOT ALLOW THE EXCLUSION OR LIMITATION OF INCIDENTAL OR CONSEQUENTIAL DAMAGES, SO THE ABOVE LIMITATION OR EXCLUSION MAY NOT APPLY TO YOU.

THIS LIMITED WARRANTY GIVES YOU SPECIFIC LEGAL RIGHTS, AND YOU MAY ALSO HAVE OTHER RIGHTS WHICH VARY FROM STATE TO STATE IN THE U.S., PROVINCE TO PROVINCE IN CANADA AND FROM COUNTRY TO COUNTRY.

For questions, comments, technical assistance or to order repair

1-800-791-9458 (M-F 9am – 5pm EST) Email:

[support@amerisuninc.com](mailto:support@amerisuninc.com)

PLEASE SAVE ALL OF YOUR ORIGINAL RECEIPTS. THIS WARRANTY IS VOID WITHOUT THEM.



