



PUMPS, SPRAY NOZZLES, AND, ACCESSORIES

PRODUCT CATALOG



TABLE OF CONTENTS

Pumps and Engines	1-134
Selecting the Right Pump	2-10
Centrifugal Pumps	11-60
Life Guard Silicon Carbide Pump Seals	58
Self-Priming Adaptor (SPA)	59
Centrifugal Pump Accessories	60
Transfer Pumps	61-67
Roller Pumps	68-78
Roller Pump Kits & Accessories	76-77
Other Pump Accessories	78
Diaphragm Pumps	79-93
Diaphragm Pump Accessories, Kits and Control Units	91-93
Shurflo Pumps	94-109
Shurflo Diaphragm Pumps	94-104
Shurflo Diaphragm Pump Accessories and Fittings	105-106
Shurflo Mini-Bulk Chemical Transfer Systems and Accessories	107-109
Piston / Plunger Pumps and Hydraulically-Driven Pressure Washers	110-127
Specialty Pumps (Versa-Twin, Noryl, Hydraulic-Driven Gear Pump and Aqua-Tiger)	128-133
PowerPro Gasoline Engines	134
Spray Nozzles	135-212
Selecting the Right Spray Nozzles	135-139
Broadcast Spray Nozzles	140-161
Broadcast Wide-Angle Spray Nozzles	162-165
Streaming Spray Nozzles	166-169
Banding and Directed Spray Nozzles	170-185
Specialty Spray Nozzles	186-196
Caps, Filters and Training Tools	197-199
Technical Information – Spray Nozzles	200-212
Accessories	213-262
ProStop-E and Fence Row Control	214-215
Express Boom Assembly	216-217
Duo React	218
ProFlo Nozzle Bodies, Accessories, Boom Clamps and Foam Marker	219-226
ProCap Tank Lids and Tank Accessories (ProClean)	227-231
Cleanload Chemical Eductor, Cleanload Max, Poly or Stainless Steel Eductor	232-234
Line Strainers	235-236
Spray Guns & Lances	237-241
Flowmeters	242
Sprayer Control Valves	243-245
Ball Valves	247-248
Gauges	248-250
Universal Flange Clamps, Gaskets and Fittings	251-252
Fittings, Cable Ties, Hose Clamps and Sealant	253-263
Index	264-278
Limited Warranty on Hypro/Shurflo Pumps and Other Hypro Products	279

CENTRIFUGAL PUMPS PAGE 11

Commonly used with self-propelled sprayers, large-trailed sprayers, and construction equipment

- ◆ Material Options: Cast Iron, Polypropylene, 316 Stainless Steel
- ◆ Pressure Range: 0-150 psi (0-10 bar)
- ◆ Flow Range: 0-1078 gpm (0-4080 lpm)

TRANSFER PUMPS PAGE 61

Commonly used with tender trailers and fluid transfer stations

- ◆ Material Options: Polypropylene, Aluminum, Cast Iron
- ◆ Pressure Range: 0-55 psi (0-3.8 bar)
- ◆ Flow Range: 0-460 gpm (0-1740 lpm)

ROLLER PUMPS PAGE 68

Commonly used with 3-point sprayers, pest control, and de-icing skids

- ◆ Material Options: Cast Iron, Ni-Resist, Silver Series XL
- ◆ Pressure Range: 0-300 psi (0-20 bar)
- ◆ Flow Range: 0-60 gpm (0-227 lpm)

DIAPHRAGM PUMPS PAGE 79

Commonly used with nutrient application systems, fruit & vegetable sprayers, and pressure cleaning system

- ◆ Material Options: Aluminum, Brass, Polypropylene
- ◆ Pressure Range: 0-725 psi (0-50 bar)
- ◆ Flow Range: 0-66 gpm (0-250 lpm)

SHURFLO DIAPHRAGM PUMPS PAGE 94

Commonly used with ATV sprayers and nutrient application systems

- ◆ Material Options: Polypropylene, Nylon
- ◆ Pressure Range: 0-150 psi (0-10 bar)
- ◆ Flow Range: 0-5 gpm (0-19 lpm)

PISTON & PLUNGER PUMPS PAGE 110

Commonly used with pressure-cleaning and car wash systems

- ◆ Material Options: Cast Iron, 316 Stainless Steel, Brass
- ◆ Pressure Range: 0-3600 psi (0-248 bar)
- ◆ Flow Range: 0-45 gpm (0-170 lpm)

SPECIALTY PUMPS PAGE 128

- ◆ Versa-Twin: transferring liquids in carpet cleaning, pest control, and turf spraying
- ◆ Noryl: bulk transfer of fertilizer and agricultural chemicals
- ◆ Aqua-Tiger: general pumping applications where a flooded intake is provided

POWERPRO ENGINES PAGE 134

SELECTING THE RIGHT PUMP

Because the pump is the “heart of the liquid system” on equipment, careful consideration must be made in selecting the right pump. Seldom is there only one pump that will do the job. To make a wise choice, you will need to know about pump types, how the pump is driven, and the flow and pressure requirements for your specific spraying system and application.

PUMP TYPES

To ensure you can closely match the pump to your needs, Pentair manufactures six different types of pumps under the Hypro and Shuflo brands: centrifugal, transfer, roller, diaphragm, piston and plunger pumps.



“Positive displacement” vs. “Non-positive displacement”

Pumps can be divided into two general categories: “positive displacement” and “non-positive displacement.”

Positive Displacement – In a positive displacement pump the flow from the pump is directly proportional to the pump speed. Liquid is captured and discharged as a fixed volume per revolution of the pump shaft. This positive flow is why all positive displacement pump installations must include a relief valve and bypass line between the pump outlet and the nozzle shut-off valve. Roller, diaphragm, piston and plunger pumps are positive displacement pumps.

Non-positive Displacement – In a non-positive displacement pump a rotating impeller creates a centrifugal force that overcomes the restriction of liquid flow through the system. If the outlet is closed, the impeller continues to rotate harmlessly without damaging system components. Centrifugal and transfer pumps are non-positive displacement pumps.

Centrifugal Pumps -Spray & Transfer Applications (non-positive displacement)

In centrifugal pumps, liquid enters through the center of a rotating impeller that is driven at speeds up to 6000 RPM. Liquid is forced to the outer edge of the housing; this centrifugal force is what delivers the liquid to the nozzle. Traditionally thought of as low to medium pressure pumps, the Hypro line of centrifugal pumps can deliver from 0-150 psi (0-10 bar) and flow rates up to 440 gpm (1760 lpm). 1078 gpm [4080 lpm] is the max flow achieved by the 9308 series centrifugal pumps. Centrifugal pumps have minimum surfaces to wear and no poppet valves, making them very durable, easy to maintain and well suited for pumping abrasive and corrosive materials. Because centrifugal pumps operate at higher speeds than the RPMs of a tractor PTO, the speed must be increased through a gear drive, belt drive, gas engine drive, or high-speed hydraulic motor drive. Pump models are specifically designed for each of these drive applications. The broad, versatile line includes models with rugged housings and components of cast iron, polypropylene, engineered plastics and stainless steel that endure the wide variety of agricultural chemicals.



SELECTING THE RIGHT PUMP



Diaphragm Pumps (positive displacement)

Diaphragm pumps are designed to isolate abrasive and corrosive solutions being pumped from its mechanical drive components through the use of synthetic diaphragms.

Diaphragm pumps are compact, self-priming and produce low-to-high pressures 0 to 725 psi (0-50 bar) with flow rates of 3.8 to 65.7 gpm (14.5 -260 lpm). Driven by 540 rpm PTO, gas engine, or hydraulic motor, diaphragm pumps are used for a variety of agricultural, horticultural and pest control spraying applications.

Shurflo pumps are efficient, 12 VDC electric motor driven low pressure diaphragm pumps designed for smaller spray applications with pressures 0-150 psi (0-10 bar) and flows 0-5.3 gpm (0-20 lpm). Shurflo pumps fit uniquely into mobile applications on ATV, home lawn care, fertilizer and pesticide equipment.



Roller Pumps (positive displacement)

The Hypro line of roller pumps are an economical choice by farmers throughout the world. The rollers revolve inside the pump housing on an

eccentric profile to force spray solution through the pump which then develops pressure and flow. The roller pump offers a compact design with mechanical simplicity to provide a low initial cost pump that is extremely versatile. They operate efficiently at PTO speeds of 540 and 1000 rpm and have a wide pressure

range of up to 300 psi (20 bar) and flow rates of 2 to 62 gpm (7 to 235 lpm). Roller pumps are self-priming and easily adapt to PTO or gas engine drives. Specific seal, roller and casting materials can be selected for compatibility with certain herbicides, pesticides, fungicides and fertilizers.



Piston and Plunger Pumps (positive displacement)

Piston/Plunger pumps have a shaft, pistons or plungers and "inlet" and "outlet" poppet valves. The design of the pump converts the rotational drive into a oscillating vertical motion. On the

down-stroke, the inlet valve opens, filling the chamber with solution. On the up-stroke, the outlet valve opens, and the piston forces the solution to the nozzle. Piston pumps deliver relatively low flow rate, less than 10 gpm (40 lpm), at pressures up to 1000 psi (69 bar). Plunger pumps are designed with ceramic plungers which can operate at higher pressures up to 3600 psi (248 bar) at flows up to 45 gpm (170 lpm). The main difference of construction is in a piston pump the sealing material moves with the piston while in a plunger pump the sealing material (u-cups) are stationary with only the plunger in motion. The replaceable piston cups can be of leather, fabric or Buna-N rubber, depending on the type of solution to be sprayed. They can be driven by 540 rpm PTO, gas engine, hydraulic or electric motor. Their low volume/ high pressure capability permits use in general spraying as well as task-oriented applications such as spraying fence rows and ditches, and hydrostatic testing. Plunger pumps are used primarily for cleaning operations.



SELECTING THE RIGHT PUMP

PUMP DRIVES

How a pump is to be driven is often a primary consideration in selecting the proper type of pump. If the power source has already been determined, the following chart may be of further help in selecting the type of pump that is best suited to your needs.

HOW DO YOU PLAN TO DRIVE THE PUMP?

If your power source is:	Method	Roller	Centrifugal and Transfer	Diaphragm	Piston/Plunger
540 rpm PTO	direct coupled:	X		X	X
	through gear drive:		X		
	through belt/pulley:		X		
1000 rpm PTO	direct coupled:	X			
	through gear drive:		X		
	through belt/pulley:		X		
Hydraulic Motor		X	X	X	X
12 Volt DC Motor		X		X	X
Gas Engine	direct coupled:	X	X		
	through gear reduction:	X		X	X
	through belt/pulley:	X	X	X	X
Electric Motor	direct coupled:	X	X		
	through belt/pulley:	X	X	X	X

SELECTING THE RIGHT PUMP

FLOW AND PRESSURE REQUIREMENTS

Pump pressure required is often dependent on the application. Whether it be low pressure band spraying or high pressure tree spraying, it is the application that dictates what pressure is needed to get the right performance at the spray nozzle. Once you know what pressure is desired choose a pump with extra pressure capacity due to losses in pressure as it goes through the system components (strainer, valves, elbows, hose, etc.) out to the nozzle.

HOW MUCH PRESSURE DO YOU NEED?

Pressure		Flow		Pump
0-150 psi (0-10 bar)		0-1078 gpm (0-4080 lpm)		Centrifugal
0-150 psi (0-10 bar)		0-5 gpm (0-20 lpm)		Shurflo Diaphragm
0-300 psi (0-20 bar)		0-60 gpm (0-225 lpm)		Roller
0-725 psi (0-50 bar)		0-60 gpm (0-225 lpm)		HYPRO Diaphragm
0-1000 psi (0-69 bar)		0-10 gpm (0-38 lpm)		Piston/Plunger
0-3600 psi (0-248 bar)		0-45 gpm (0-170 lpm)		Plunger

Pump flow required is dependent on several factors. Application rate, width of boom or size of nozzle, speed of travel and agitation. To review your pump flow requirements follow through the calculations presented on the following pages. As with pressure you will want to choose a pump that has additional flow so that it meets your application needs over time as performance drops due to component wear.

HOW MUCH FLOW DO YOU NEED?

Flow		Pressure		Pump
0-5 gpm (0-20 lpm)		0-150 psi (0-10 bar)		Shurflo Diaphragm
0-10 gpm (0-38 lpm)		0-1000 psi (0-70 bar)		Piston/Plunger
0-45 gpm (0-170 lpm)		0-3600+ psi (248+ bar)		Plunger
0-60 gpm (0-225 lpm)		0-300 psi (0-20 bar)		Roller
0-60 gpm (0-225 lpm)		0-725 psi (0-50 bar)		HYPRO Diaphragm
0-1078 gpm (0-4080 lpm)		0-150 psi (0-10 bar)		Centrifugal

SELECTING THE RIGHT PUMP

Determining Pump Flow and Pressure Requirements

Every pumping task has an optimum volume and pressure requirement. Determining that optimum (and selecting the pump that delivers it) is key to an efficient and economical spraying system operation.

Pressure requirements for agricultural pumps are dependent on both the material to be applied and application targets. Soil-applied herbicides generally require a relatively low pressure pump rating of 30-60 psi with foliar-applied herbicides at the top end of that range and slightly higher. Insecticides and fungicides can require higher pressure ratings of 100 to 500 psi. Pressure must be sufficient, in the case of heavy foliage field crops and orchard crops, to penetrate the leaf foliage. In the case of orchard crops, pressure must also be sufficient to carry material up and over as well as into the canopy.

A number of factors must be considered to properly determine the total flow you will need from your pump. They include:

- ◆ Type of spray operation (broadcast, banding, low-level, etc.)
- ◆ The chemical's application rate, ground speed, boom width, hose length, tank agitation, etc.

The spray task is the first consideration in determining flow rate and pressure needs. The following formulas and calculations may help.

Calculating Agitation Requirements

The pump must produce enough flow for both the application rate and tank agitation requirements. Too little agitation will not keep the solution in proper suspension and too much agitation may cause foaming. Here are rule of thumb formulas for calculating how much additional pump flow you will need for agitation.

Liquids:

$$\text{Tank volume (gallons)} \times .05 = \text{total agitation in gpm}$$

or

$$\text{Tank volume (litres)} \times .05 = \text{total agitation in lpm}$$

Wetable Powders and Flowables:

$$\text{Tank volume (gallons)} \times .125 = \text{total agitation in gpm}$$

or

$$\text{Tank volume (litres)} \times .125 = \text{total agitation in lpm}$$

EXAMPLE: If you will be spraying a wettable powder from a 100-gallon tank, proper agitation will require 12.5 gpm additional flow from the pump.

Reducing Agitation Flow Requirements

Agitation flow requirements can be reduced by using jet agitation in the tank. Jet agitators use a venturi design to multiply agitation output. Depending on the jet agitator model and pressure, one gallon per minute input can provide two to ten gallons per minute agitation output. If your sprayer is equipped with a jet agitator, consult the operator's manual or documentation to find the output to input ratio and adjust your flow required for agitation accordingly.

Agitation Flow with Jet Agitation:

$$\text{required gpm} \times \frac{\text{input}}{\text{output}}$$

or

$$\text{required lpm} \times \frac{\text{input}}{\text{output}}$$

For example: If you calculate a requirement of 63 gpm of agitation and your jet agitator produces 3 to 1 output to input ratio, your pump would only need 1/3 of 63 gpm, or 21 gpm.

SELECTING THE RIGHT PUMP

Factor in an "Excess Flow" Requirement

It is wise to have some excess flow capacity so you will not end up with an undersized pump because actual operation conditions may cause changes in spray system performance (such as normal pump wear, operating at less than rated speeds, etc.). Hypro recommends you add an additional 20% to your calculated total pump flow requirement to compensate for these variables. Plumbing systems have a number of restrictions that will result in a pressure drop from the pump to the actual spray point. These must be taken into account and minimized.

Calculating Pump Flow for Broadcast Boom Sprayers

Chemical application is measured in gallons per acre (gpa) or litres per hectare (l/ha), whereas pump flow is stated in gallons per minute (gpm) or litres per minute (lpm). To calculate the pump flow required by a broadcast boom sprayer, multiply the application rate (from the chemical label) by the sprayer ground speed. Multiply the sum by the boom width on your sprayer. Then, divide that number by 495 for US units or by 600 for metric units. As a formula, it is written like this:

Flow required for boom:

$$\text{gpm} = \frac{\text{gpa} \times \text{mph} \times \text{boom width (ft.)}}{495}$$

or

$$\text{lpm} = \frac{\text{l/ha} \times \text{km/hr} \times \text{boom width (m)}}{600}$$

The result will be the pump flow required to deliver the proper application rate at the boom's nozzles. Then calculate your total pump flow requirement (broadcast):

Flow required for boom	_____ gpm	
Flow required for agitation	+ _____ gpm	
Sub-total	= _____ gpm	
Excess flow requirement	x <u>1.20</u>	
TOTAL PUMP FLOW NEEDED	_____ gpm	

OR

Flow required for boom	_____ lpm	
Flow required for agitation	+ _____ lpm	
Sub-total	= _____ lpm	
Excess flow requirement	x <u>1.20</u>	
TOTAL PUMP FLOW NEEDED	_____ lpm	

Calculating Pump Flow for Banding Sprayers

First, multiply the band width by the number of rows to determine the total width (w). Then, multiply the application rate (from the chemical label) by the ground speed. Multiply that result by the total width (w) calculated earlier, then divide the result by 5940 for US units or 60,000 for metric units. Here's how the formula appears:

Total band width of sprayer:

$$w = \text{rows} \times \text{band width (inches)}$$

or

$$w = \text{rows} \times \text{band width (cm)}$$

Flow required for banding nozzles:

$$\text{gpm} = \frac{\text{gpa} \times \text{mph} \times w}{5940}$$

or

$$\text{lpm} = \frac{\text{l/ha} \times \text{km/hr} \times w}{60,000}$$

The result will be the pump flow required to deliver the proper application rate at the boom's nozzles. Then calculate your total pump flow requirement (banding):

Flow required for boom	_____ gpm	
Flow required for agitation	+ _____ gpm	
Sub-total	= _____ gpm	
Excess flow requirement	x <u>1.20</u>	
TOTAL PUMP FLOW NEEDED	_____ gpm	

OR

Flow required for boom	_____ lpm	
Flow required for agitation	+ _____ lpm	
Sub-total	= _____ lpm	
Excess flow requirement	x <u>1.20</u>	
TOTAL PUMP FLOW NEEDED	_____ lpm	

SELECTING THE RIGHT PUMP

Calculating Pump Flow for Hand Gun Spraying

For low-level spraying with a hand gun, such as for lawn and turf care, professional applicators typically “walk” the lawn at about 1,000 sq. ft. per minute or 100 sq. m per minute. That means the “gpm” or “lpm” rate of the hand gun will generally be the same as “gallons per 1,000 sq. ft.” or “litres per 100 sq. m.”

To Determine Your Total Pump Flow Requirement:

Flow required for gun/nozzle:	_____	Litres per 1,000ft ² (same as gpm)
Flow required for agitation: +	_____	gpm
Sub-total =	_____	gpm
Excess flow requirement: x	1.20	
TOTAL PUMP FLOW NEEDED:	_____	gpm

Flow required for gun/nozzle:	_____	Litres per 1,000ft ² (same as gpm)
Flow required for agitation: +	_____	lpm
Sub-total =	_____	lpm
Excess flow requirement: x	1.20	
TOTAL PUMP FLOW NEEDED:	_____	lpm

Use this same method for calculating the pump flow requirement for high pressure spraying, such as trees. Even though the application “rate” is usually a visual saturation of the tree, the known gpm or lpm factor will be the hand gun nozzle output, which is the rate you use for the calculation.

Calculating Pump Pressure for Hand Gun Spraying

For most hand gun chemical spraying, 40 psi (3 bar) at the nozzle is typical. To properly select a pump that can deliver the right nozzle pressure, you must consider the normal “pressure drop” that occurs within the length of hose. The amount of pressure drop through the hose depends on hose length, hose diameter and flow rate. For example, 300’ (90 m) of 1/2” hose spraying at 6 gpm (23 lpm), will have a pressure drop of approximately 120 psi (8 bar). That means you need a pump delivering at least 160 psi (12 bar) in order to ensure 40 psi (3 bar) at the nozzle.

Desired pressure at gun nozzle:	_____	psi
Hose pressure loss: +	_____	psi
TOTAL PUMP PRESSURE NEEDED: =	_____	psi

or

Desired pressure at gun nozzle:	_____	bar
Hose pressure loss: +	_____	bar
TOTAL PUMP PRESSURE NEEDED: =	_____	bar

NOTE: When determining the total pump pressure requirement for high tree spraying, you must also consider the spray height (or reach) you need to attain. Generally, pumps of up to 700 psi (50 bar) are used for this purpose.

Pressure Loss at Various Rates of Flow of Water Through Hose*

at temperature of 68° Fahrenheit (20°C.)

*1/4-inch to 1-inch inside diameter

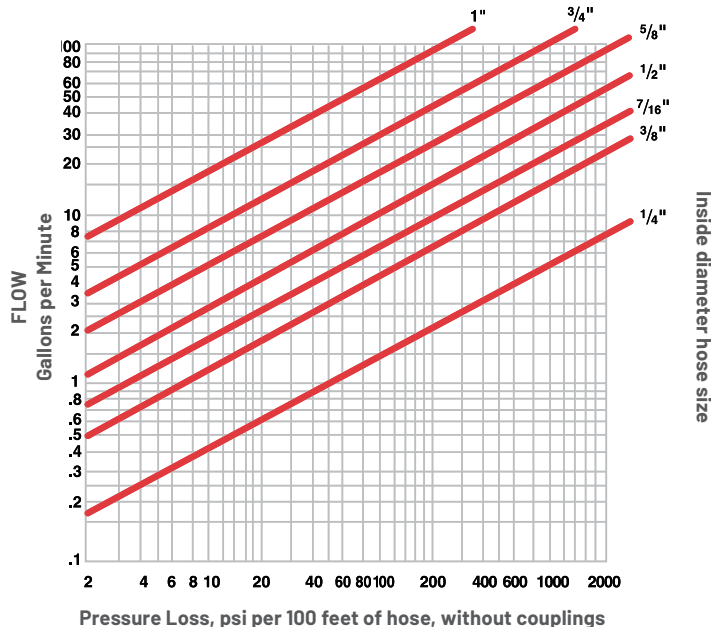

SYSTEM HOOK-UPS

Centrifugal Pumps

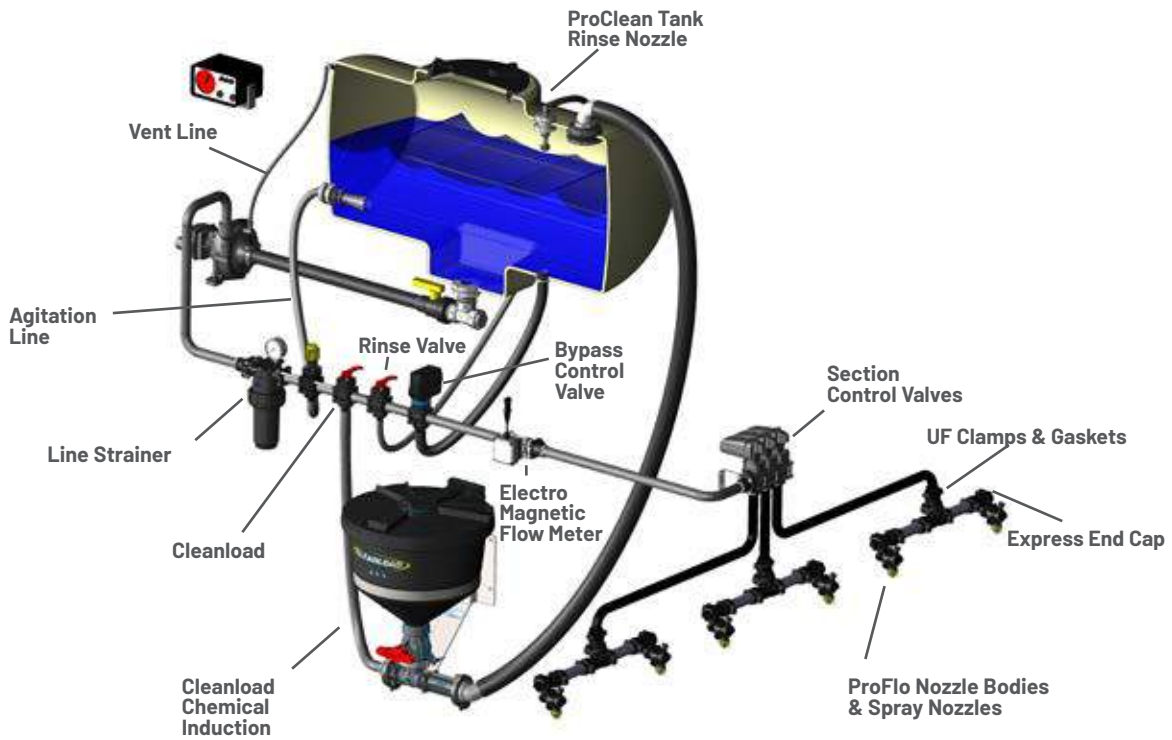

SYSTEM HOOK-UPS

Roller, Diaphragm Pumps

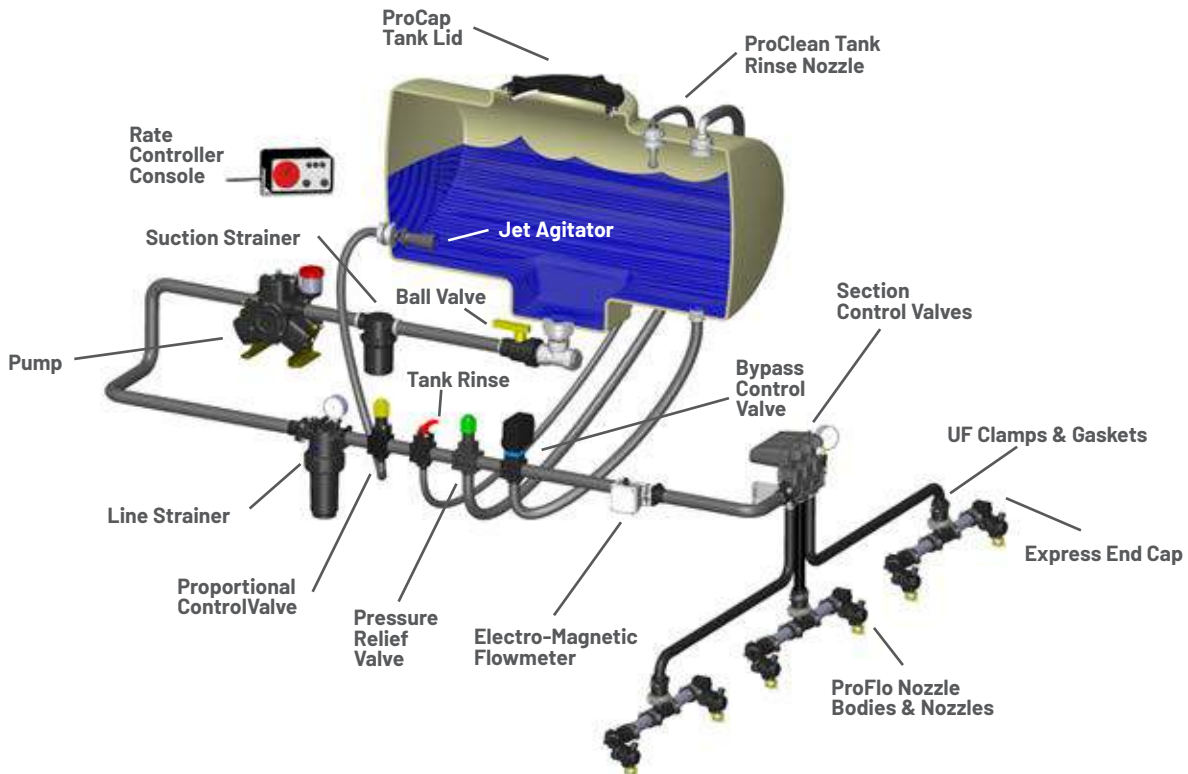

Hypro carries all parts labeled above. Please contact your local Hypro dealer by using the "Where to Buy" function on our website at pentair.com, or call 1-800-424-9776 for more information.

SYSTEM HOOK-UPS

Diaphragm Pumps, High Pressure Applications

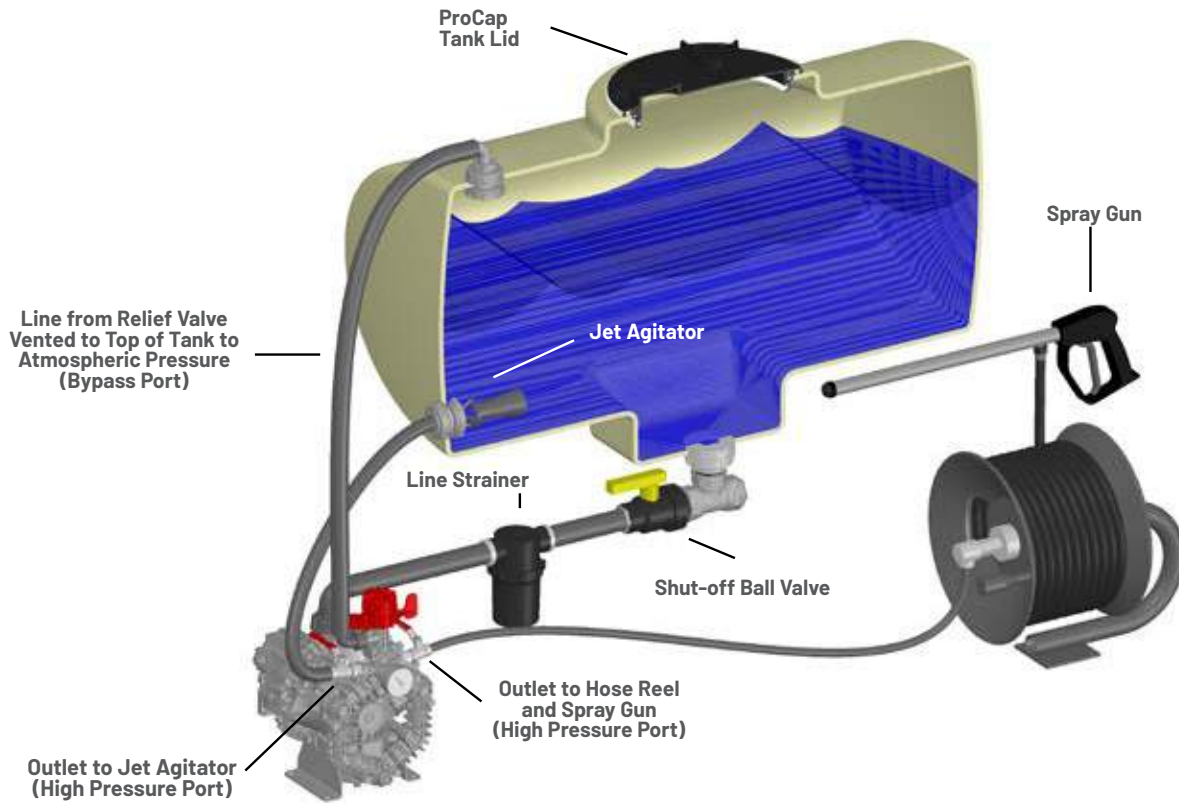

SYSTEM HOOK-UPS

Small Twin[®] Piston Pumps

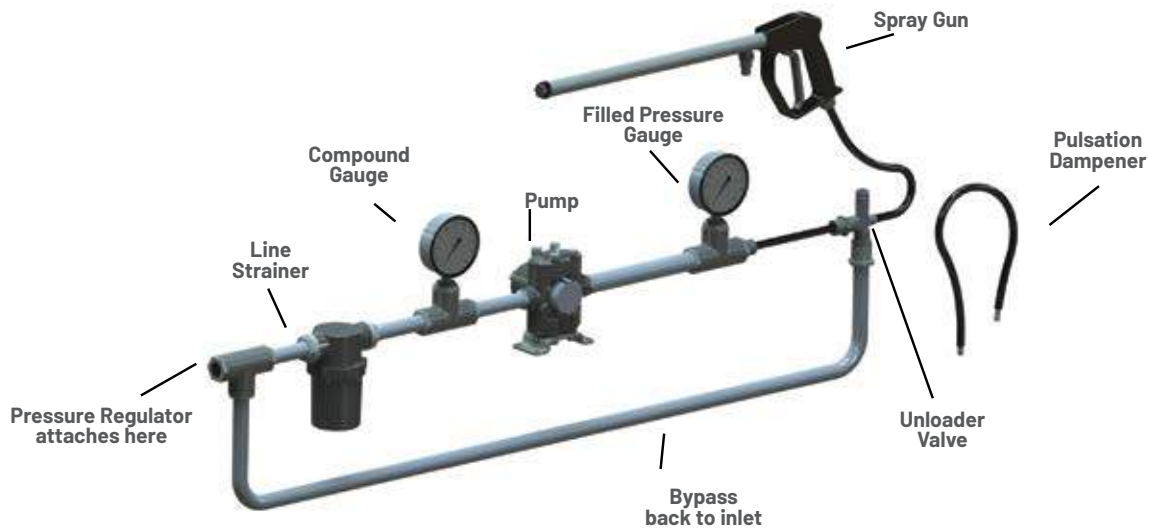

Hypro carries all parts labeled above. Please contact your local Hypro dealer by using the "Where to Buy" function on our website at pentair.com, or call 1-800-424-9776 for more information.

GEAR DRIVEN, CAST IRON

Series 9000C-0



UPGRADE OPTIONS:

- ◆ Increase dry-run and abrasive resistance with Life Guard Seals
 - Life Guard seals are the OEM standard

FEATURES

- ◆ Planetary oil-bath gear drive
- ◆ Port sizes: 1-1/2" NPT inlet, 1-1/4" NPT outlet
- ◆ Max. fluid temperature: 140°F/60°C
- ◆ Housing: Cast iron
- ◆ Impeller: Nylon
- ◆ Pump shaft rotation: Counter clockwise when looking at the shaft end
- ◆ Pump seals: Viton®/ceramic standard; Life Guard silicon carbide (B) available
- ◆ Life Guard seals are the industry standard on OEM equipment
- ◆ Weight: 44 lbs./20 kg

ORDER INFORMATION

Model Number	Max GPM	Max LPM	Max PSI	Max BAR	Max RPM	PTO Output	Locking Collar and Mounting Clip
9006C-0	117	443	78	5.4	600	1-3/8" 6 spline (SAE) 540 rpm female	x
9008C-0	110	416	75	5.2	1000	1-3/8" 21 spline (SAE) 1000 rpm female	x
9016C-0	117	443	78	5.4	600	1" (25.4 mm) Solid Shaft	
9018C-0	110	416	75	5.2	1000	1" (25.4 mm) Solid Shaft	
9028C-0	110	416	75	5.2	1000	1-3/4" 20 spline (SAE) 1000 rpm female	x
90029	110	416	75	5.2	1000	38mm 8 spline 1000 rpm female	x
3430-0334	Seal and o-ring repair kit						
3430-0591	Life Guard silicon carbide seal kit						

Life Guard silicon carbide seal - Add suffix "B" (i.e.: 9006C-0-B)

9006C-0, 9016C-0

U.S. UNITS

RPM	GPM at 20 PSI	GPM at 30 PSI	GPM at 40 PSI	GPM at 50 PSI	GPM at 60 PSI	GPM at 70 PSI
500	97	86	71	47		
540	106	96	87	70	47	
600	117	113	104	96	82	63

9006C-0, 9016C-0

METRIC UNITS

RPM	LPM at 1.4 BAR	LPM at 2.1 BAR	LPM at 2.8 BAR	LPM at 3.4 BAR	LPM at 4.1 BAR	LPM at 4.8 BAR
500	367	326	269	178		
540	401	363	329	265	178	
600	443	428	394	363	310	238

9008C-0, 9018C-0, 9028C-0, 90029

U.S. UNITS

RPM	GPM at 20 PSI	GPM at 30 PSI	GPM at 40 PSI	GPM at 50 PSI	GPM at 60 PSI	GPM at 70 PSI
800	82	70	53			
900	96	88	76	60	24	
1000	110	102	96	86	70	46

9008C-0, 9018C-0, 9028C-0, 90029

METRIC UNITS

RPM	LPM at 1.4 BAR	LPM at 2.1 BAR	LPM at 2.8 BAR	LPM at 3.4 BAR	LPM at 4.1 BAR	LPM at 4.8 BAR
800	310	265	201			
900	363	333	288	227	91	
1000	416	386	363	326	265	174

Viton® is a registered trademark of DuPont. Hypro® is a registered trademark of Pentair.

GEAR DRIVEN, CAST IRON, SELF-PRIMING

Series 9000C-0-SP



UPGRADE OPTIONS:

- ◆ Increase dry-run and abrasive resistance with Life Guard Seals
 - Life Guard seals are the OEM standard

FEATURES:

- ◆ Planetary oil-bath gear drive
- ◆ Port sizes: 1-1/2" NPT inlet, 1-1/4" NPT outlet
- ◆ Max. fluid temperature: 140°F/60°C
- ◆ Housing: Cast iron
- ◆ Impeller: Nylon
- ◆ Pump shaft rotation: Counter clockwise when looking at the shaft end
- ◆ Pump seals: Viton®/ceramic standard; Life Guard silicon carbide (B) available
- ◆ Life Guard seals are the industry standard on OEM equipment
- ◆ Weight: 62 lbs./28.2 kg

ORDER INFORMATION

Model Number	Max GPM	Max LPM	Max PSI	Max BAR	Max RPM	PTO Output	Locking Collar and Mounting Clip
9006C-0-SP	119	450	77	5.3	600	1-3/8" 6 spline (SAE) 540 rpm	x
9016C-0-SP	119	450	77	5.3	600	1" (25.4 mm) solid shaft	
9028C-0-SP	117	443	69	4.35	1000	1-3/4" 20 spline (SAE) 1000 rpm	x
3430-0334						Seal and o-ring repair kit	
3430-0591						Life Guard silicon carbide seal kit	
3430-0480SP						Self priming chamber kit	

Life Guard silicon carbide seal - Available upon request

9006C-0-SP, 9016C-0-SP

U.S. UNITS

RPM	GPM at 10 PSI	GPM at 20 PSI	GPM at 30 PSI	GPM at 40 PSI	GPM at 50 PSI	GPM at 60 PSI	GPM at 70 PSI
500	101	95	77	51	12		
540	111	109	94	74	47	11	
600	119	118	112	97	79	54	23

9028C-0-SP

U.S. UNITS

RPM	GPM at 10 PSI	GPM at 20 PSI	GPM at 30 PSI	GPM at 40 PSI	GPM at 50 PSI	GPM at 60 PSI	GPM at 70 PSI
800	91	81	57	19			
940	105	101	84	60	25		
1000	117	114	104	87	65	33	23

9006C-0-SP, 9016C-0-SP

METRIC UNITS

RPM	LPM at 0.7 BAR	LPM at 1.4 BAR	LPM at 2.1 BAR	LPM at 2.8 BAR	LPM at 3.4 BAR	LPM at 4.1 BAR	LPM at 4.8 BAR
500	382	360	291	193	45		
540	420	413	356	280	178	42	
600	450	447	424	367	299	204	87

9028C-0-SP

METRIC UNITS

RPM	LPM at .07 BAR	LPM at 1.4 BAR	LPM at 2.1 BAR	LPM at 2.8 BAR	LPM at 3.4 BAR	LPM at 4.1 BAR	LPM at 4.8 BAR
800	344	307	216	72			
940	397	382	318	227	95		
1000	443	432	394	329	246	125	87

Viton® is a registered trademark of DuPont. Hypro® is a registered trademark of Pentair.

GEAR DRIVEN, POLYPROPYLENE

Series 9000P-0



UPGRADE OPTIONS:

- ◆ Increase abrasive resistance with Life Guard Seals
 - Life Guard seals are the OEM standard

FEATURES:

- ◆ Planetary oil-bath gear drive
- ◆ Port sizes: 1-1/2" NPT inlet, 1-1/4" NPT outlet
- ◆ Max. fluid temperature: 140°F/60°C
- ◆ Housing: Polypropylene
- ◆ Impeller: Polypropylene
- ◆ Pump shaft rotation: Counter clockwise when looking at the shaft end
- ◆ Pump seals: Viton®/ceramic standard; Life Guard silicon carbide (B) available
- ◆ Life Guard seals are the industry standard on OEM equipment
- ◆ Weight: 37 lbs./16.8 kg

ORDER INFORMATION

Model Number	Max GPM	Max LPM	Max PSI	Max BAR	Max RPM	PTO Output	Locking Collar Kit
9006P-0	97	367	83	5.7	600	1 3/8" 6 spline (SAE) 540 rpm female	x
9008P-0	94	355	67	4.6	1000	1 3/8" 21 spline (SAE) 1000 rpm female	x
9016P-0	97	367	83	5.7	600	1" (25.4 mm) solid shaft	
9018P-0	94	355	67	4.6	1000	1" (25.4 mm) solid shaft	
3430-0333	Seal and o-ring repair kit						
3430-0590	Life Guard silicon carbide seal kit						

Life Guard silicon carbide seal - Add suffix "B" (i.e.: 9006P-0-B)

9006P-0, 9016P-0

U.S. UNITS

RPM	GPM at 10 PSI	GPM at 20 PSI	GPM at 30 PSI	GPM at 40 PSI	GPM at 50 PSI	GPM at 60 PSI	GPM at 70 PSI
450	73	63	52	34			
500	81	77	67	55	37		
550	88	85	78	68	56	36	
600	97	97	93	85	76	66	52

9006P-0, 9016P-0

METRIC UNITS

RPM	LPM at 0.7 BAR	LPM at 1.4 BAR	LPM at 2.1 BAR	LPM at 2.8 BAR	LPM at 3.4 BAR	LPM at 4.1 BAR	LPM at 4.8 BAR
450	276	239	196	129			
500	307	291	255	208	142		
550	333	323	295	257	210	137	
600	367	367	354	323	288	249	198

Viton® is a registered trademark of DuPont. Hypro® is a registered trademark of Pentair.

9008P-0, 9018P-0

U.S. UNITS

RPM	GPM at 10 PSI	GPM at 20 PSI	GPM at 30 PSI	GPM at 40 PSI	GPM at 50 PSI	GPM at 60 PSI
800	70	64	53	34		
900	83	79	70	58	42	
1000	96	92	86	78	67	52

9008P-0, 9018P-0

METRIC UNITS

RPM	LPM at 0.7 BAR	LPM at 1.4 BAR	LPM at 2.1 BAR	LPM at 2.8 BAR	LPM at 3.4 BAR	LPM at 4.1 BAR
800	314	243	200	128		
900	363	299	265	220	161	
1000	327	348	327	296	254	198

PEDESTAL MOUNT, CAST IRON & STAINLESS STEEL

Series 9202C and 9202S



UPGRADE OPTIONS:

- ◆ Increase dry-run and abrasive resistance with Life Guard Seals
 - Life Guard seals are the OEM standard
- ◆ Extend pump life with Stainless Steel
 - Fact: Chemical corrosion, pump cavitation, and abrasive wear are key factors in pump life
 - 316 Stainless Steel pumps provide superior chemical corrosion resistance, while maintaining material strength to prolong the life against abrasive wear
 - 316 Stainless Steel resists cavitation pitting of pumps, extending the wear life
 - Drop in replacements for cast iron pumps

FEATURES:

- ◆ Available in cast iron and 316 stainless steel for extended pump life
- ◆ Pedestal mount, direct drive
- ◆ Port sizes: 1-1/4" NPT inlet, 1" NPT outlet
- ◆ Max. fluid temperature: 140°F/60°C
- ◆ Impeller: Nylon (cast iron standard); polypropylene (stainless standard)
- ◆ Pump shaft rotation: Counter clockwise when looking at the shaft end, 9202S-R is Clockwise
- ◆ Pump seals: Viton®/ceramic standard (Life Guard silicon carbide (B) available); Life Guard silicon carbide standard in stainless steel pumps
- ◆ Life Guard seals are the industry standard on OEM equipment
- ◆ Weight: 18 lbs./8.2 kg

ORDER INFORMATION

Model Number	Max GPM	Max LPM	Max PSI	Max BAR	Max RPM	Shaft Output
9202C	103	390	170	11.7	6000	5/8" (15.9 mm) solid shaft
9202S	103	390	170	11.7	6000	5/8" (15.9 mm) stainless steel shaft
9202S-R	103	390	170	11.7	6000	5/8" (15.9 mm) stainless steel shaft
3430-0332	Seal and o-ring repair kit					
3430-0589	Life Guard silicon carbide seal kit					

Life Guard silicon carbide seal - Add suffix "B" (i.e.: 9202C-B)

9202C, 9202S, 9202S-R

U.S. UNITS

RPM	10 PSI		20 PSI		40 PSI		60 PSI		80 PSI		100 PSI		120 PSI		140 PSI	
	GPM	HP	GPM	HP	GPM	HP	GPM	HP	GPM	HP	GPM	HP	GPM	HP	GPM	HP
2400	50	1.3	46	1.2												
3600	67	3.7	66	3.7	62	3.5	34	2.6								
4200	75	5.7	75	5.7	75	5.7	66	5.3	44	4.2						
5000	88	9.3	88	9.3	88	9.3	88	9.3	77	8.6	60	7.5	24	6.4		
6000	103	15.6	103	15.6	103	15.6	103	15.6	103	15.6	100	15.5	91	14.8	75	14

9202C, 9202S, 9202S-R

METRIC UNITS

RPM	0.7 BAR		1.4 BAR		2.8 BAR		4.1 BAR		5.5 BAR		6.9 BAR		8.3 BAR		9.7 BAR	
	LPM	HP	LPM	HP	LPM	HP	LPM	HP	LPM	HP	LPM	HP	LPM	HP	LPM	HP
2400	189	1.3	174	1.2												
3600	254	3.7	250	3.7	235	3.5	129	2.6								
4200	284	5.7	284	5.7	284	5.7	250	5.3	167	4.2						
5000	333	9.3	333	9.3	333	9.3	333	9.3	291	8.6	227	7.5	91	6.4		
6000	390	15.6	390	15.6	390	15.6	390	15.6	390	15.6	379	15.5	344	14.8	284	14

Viton® is a registered trademark of DuPont. Hypro® is a registered trademark of Pentair.

PEDESTAL MOUNT, CAST IRON & STAINLESS STEEL

Series 9203C and 9203S



UPGRADE OPTIONS:

- ◆ Increase dry-run and abrasive resistance with Life Guard Seals
 - Life Guard seals are the OEM standard
- ◆ Extend pump life with Stainless Steel
 - Fact: Chemical corrosion, pump cavitation, and abrasive wear are key factors in pump life
 - 316 Stainless Steel pumps provide superior chemical corrosion resistance, while maintaining material strength to prolong the life against abrasive wear
 - 316 Stainless Steel resists cavitation pitting of pumps, extending the wear life
 - Drop in replacements for cast iron pumps

FEATURES:

- ◆ Available in cast iron and 316 stainless steel for extended pump life
- ◆ Pedestal mount, direct drive
- ◆ Port sizes: 1-1/2" NPT inlet, 1-1/4" NPT outlet
- ◆ 220 x 200 Universal flange available (U)
- ◆ Max. fluid temperature: 140°F/60°C
- ◆ Impeller: Nylon (cast iron standard); polypropylene (stainless standard); GTX available
- ◆ Pump shaft rotation: Counter clockwise when looking at the shaft end; 9203C-R is clockwise
- ◆ Pump seals: Cast Iron models - Viton®/ceramic standard; Life Guard silicon carbide (B) available; Stainless Steel models - Life Guard silicon carbide standard
- ◆ Life Guard seals are the industry standard on OEM equipment
- ◆ Weight: 19 lbs./8.6 kg

FOR FLANGED CONNECTIONS YOU WILL ALSO NEED:

- Universal Flange Gasket Universal Flange Clamp

See 251 for details

ORDER INFORMATION

Model Number	Max GPM	Max LPM	Max PSI	Max PSI (BAR)	Max RPM	Shaft Output
9203C †	140	530	170	11.7	6000	5/8" (15.9 mm) solid shaft
9203C-R (CW)	140	530	170	11.7	6000	5/8" (15.9 mm) solid shaft
9203S †	140	530	170	11.7	6000	5/8" (15.9 mm) stainless steel shaft
9203S-R (CW)	140	530	170	11.7	6000	5/8" (15.9 mm) stainless steel shaft
3430-0332	Seal and o-ring repair kit					
3430-0589	Life Guard silicon carbide seal kit					

† Universal Flange (220 x 200) - Add Suffix "U" (i.e.: 9203C-U)
Life Guard silicon carbide seal - Add suffix "B" (i.e.: 9203C-B)

9203C, 9203S, 9203C-R, 9203S-R

U.S. UNITS

RPM	10 PSI		20 PSI		40 PSI		60 PSI		80 PSI		100 PSI		120 PSI		140 PSI	
	GPM	HP	GPM	HP	GPM	HP	GPM	HP	GPM	HP	GPM	HP	GPM	HP	GPM	HP
2400	80	1.9	65	1.8												
3600	105	5.3	105	5.3	92	5.0	50	3.7								
4200	122	8.2	120	7.9	115	7.7	98	7.1	56	5.3						
5000	140	12.6	140	12.6	138	12.6	130	12.2	118	11.6	88	9.9	45	7.2		
5500	140	14.9	140	14.9	138	14.9	135	15.2	130	15.2	118	14.4	90	12.5	60	9.8
6000	140	17.1	140	17.1	140	17.5	140	18.0	135	18.2	132	18	125	18.2	103	16.3

9203C, 9203S, 9203C-R, 9203S-R

METRIC UNITS

RPM	0.7 BAR		1.4 BAR		2.8 BAR		4.1 BAR		5.5 BAR		6.9 BAR		8.3 BAR		9.7 BAR	
	LPM	HP	LPM	HP	LPM	HP	LPM	HP	LPM	HP	LPM	HP	LPM	HP	LPM	HP
2400	303	1.9	246	1.8												
3600	397	5.3	397	5.3	348	5.0	189	3.7								
4200	462	8.2	454	7.9	435	7.7	371	7.1	212	5.3						
5000	530	12.6	530	12.6	522	12.6	492	12.2	447	11.6	333	9.9	170	7.2		
5500	530	14.9	530	14.9	522	14.9	511	15.2	492	15.2	447	14.4	341	12.5	227	9.8
6000	530	17.1	530	17.1	530	17.5	530	18.0	511	18.2	500	18	473	18.2	409	16.3

PEDESTAL MOUNT, CAST IRON & STAINLESS STEEL, SELF-PRIMING

Series 9203C-SP and 9203S-SP



UPGRADE OPTIONS:

- ◆ Increase dry-run and abrasive resistance with Life Guard Seals
 - Life Guard seals are the OEM standard
- ◆ Extend pump life with Stainless Steel
 - Fact: Chemical corrosion, pump cavitation, and abrasive wear are key factors in pump life
 - 316 Stainless Steel pumps provide superior chemical corrosion resistance, while maintaining material strength to prolong the life against abrasive wear
 - 316 Stainless Steel resists cavitation pitting of pumps, extending the wear life
 - Drop in replacements for cast iron pumps

FEATURES:

- ◆ Available in cast iron and 316 stainless steel for extended pump life
- ◆ Pedestal mount, direct drive
- ◆ Port sizes: 1-1/2" NPT inlet, 1-1/4" NPT outlet (9203C-SP, 9203S-SP); 2" NPT inlet, 2" NPT outlet (9203C-R-SP)
- ◆ Max. fluid temperature: 140°F/60°C
- ◆ Impeller: Nylon (cast iron standard); polypropylene (stainless steel); GTX available
- ◆ Pump shaft rotation: Counter clockwise when looking at the shaft end; 9203C-R-SP is clockwise
- ◆ Pump seals: Cast Iron models - Viton®/ceramic standard; Life Guard silicon carbide (B) available; Stainless Steel models - Life Guard silicon carbide standard
- ◆ Life Guard seals are the industry standard on OEM equipment
- ◆ Weight: 31.7 lbs./14.4 kg - Stainless Steel; 29 lbs./13.2 kg - Cast Iron

ORDER INFORMATION

Model Number	Max GPM	Max LPM	Max PSI	Max BAR	Max RPM	Shaft Output
9203C-SP	120	454	157	10.8	6000	5/8" (15.9 mm) solid shaft
9203C-R-SP(CW)	140	530	155	10.7	6000	5/8" (15.9 mm) solid shaft
9203S-SP	120	454	157	10.8	6000	5/8" (15.9 mm) stainless steel shaft
3430-0332	Seal and o-ring repair kit					
3430-0589	Life Guard silicon carbide seal kit					
3430-0480SP	Self priming chamber kit					
3430-0482SP	Self priming chamber kit for reverse rotation ONLY					

Life Guard silicon carbide seal - Add suffix "B" (i.e.: 9203C-SP-B)

PEDESTAL MOUNT, CAST IRON & STAINLESS STEEL, SELF-PRIMING

Series 9203C-SP and 9203S-SP

9203C-R-SP

U.S. UNITS

RPM	20 PSI		40 PSI		60 PSI		80 PSI		100 PSI		120 PSI		140 PSI	
	GPM	HP	GPM	HP	GPM	HP	GPM	HP	GPM	HP	GPM	HP	GPM	HP
3600	80	3.8	43	2.9										
4200	102	6.1	76	5.4	38	4								
5000	127	10.5	109	9.8	86	8.7	55	7.2	18	5.4				
5500	135	13.5	125	13.1	110	12.3	83	10.9	57	9.3	21	6.9		
6000	138	15.7	132	15.7	122	15.1	111	14.1	93	13.2	67	12.2	32	9.5

9203C-R-SP

METRIC UNITS

RPM	1.4 BAR		2.8 BAR		4.1 BAR		5.5 BAR		6.9 BAR		8.3 BAR		9.7 BAR	
	LPM	HP	LPM	HP	LPM	HP	LPM	HP	LPM	HP	LPM	HP	LPM	HP
3600	303	3.8	163	2.9										
4200	386	6.1	288	5.4	144	4								
5000	481	10.5	413	9.8	326	8.7	208	7.2	68	5.4				
5500	511	13.5	473	13.1	416	12.3	314	10.9	216	9.3	79	6.9		
6000	522	15.7	500	15.7	462	15.1	420	14.1	352	13.2	254	12.2	121	9.5

9203C-SP, 9203S-SP

U.S. UNITS

RPM	20 PSI		40 PSI		60 PSI		80 PSI		100 PSI		120 PSI		140 PSI	
	GPM	HP	GPM	HP	GPM	HP	GPM	HP	GPM	HP	GPM	HP	GPM	HP
3600	101	4.2	60	3.4										
4200	118	6.7	97	6.1	54	4.7								
5000	120	10.1	119	10.3	110	10.1	78	8.7	25	5.8				
5500	120	12.1	119	12.7	116	13.2	110	12.8	79	11.0	29	7.6		
6000	120	14.3	119	15.0	116	15.7	114	16.0	110	16.0	82	14.0	40	10.6

9203C-SP, 9203S-SP

METRIC UNITS

RPM	1.4 BAR		2.8 BAR		4.1 BAR		5.5 BAR		6.9 BAR		8.3 BAR		9.7 BAR	
	LPM	HP	LPM	HP	LPM	HP	LPM	HP	LPM	HP	LPM	HP	LPM	HP
3600	382	4.2	227	3.4										
4200	447	6.7	367	6.1	204	4.7								
5000	458	10.1	450	10.3	416	10.1	295	8.7	95	5.8				
5500	458	12.1	450	12.7	439	13.2	416	12.8	299	11.0	110	7.6		
6000	458	14.3	450	15.0	439	15.7	432	16.0	416	16.0	310	14.0	157	10.6

PEDESTAL MOUNT, CAST IRON

Series 9205C



UPGRADE OPTIONS:

- ◆ Increase dry-run and abrasive resistance with Life Guard Seals
 - Life Guard seals are the OEM standard

FEATURES:

- ◆ Pedestal mount, direct drive
- ◆ Port sizes: 2" NPT inlet, 1-1/2" NPT outlet
- ◆ Max. fluid temperature: 140°F/60°C
- ◆ Housing: Cast iron
- ◆ Impeller: Nylon
- ◆ Pump shaft rotation: Counter clockwise when looking at the shaft end
- ◆ Pump seals: Viton®/ceramic standard; Life Guard silicon carbide (B) available
- ◆ Life Guard seals are the industry standard on OEM equipment
- ◆ Weight: 47 lbs./21.4 kg

ORDER INFORMATION

Model Number	Max GPM	Max LPM	Max PSI	Max BAR	Max RPM	Shaft Output
9205C	180	681	196	13.5	4200	7/8" (22.2 mm) solid keyed shaft
3430-0537	Seal and o-ring repair kit					
3430-0646	Life Guard silicon carbide seal kit					
2526-0011	Clutch/single groove					

Life Guard silicon carbide seal - Add suffix "B" (i.e.: 9205C-B)

9205C

U.S. UNITS

RPM	20 PSI		40 PSI		60 PSI		80 PSI		100 PSI		120 PSI		140 PSI		160 PSI	
	GPM	HP	GPM	HP	GPM	HP	GPM	HP	GPM	HP	GPM	HP	GPM	HP	GPM	HP
3000	165	11.4	164	11.7	154	11.6	104	9.5								
3400	175	14.8	175	15.5	173	16.3	168	16.3	127	14.2	43	8.7				
3800	180	18.2	180	18.8	180	19.8	178	21.1	173	21.8	156	20.7	112	17.5		
4200	180	21.9	180	22.0	180	24.0	180	25.3	180	26.9	177	27.9	173	28.1	157	26.4

9205C

METRIC UNITS

RPM	1.4 BAR		2.8 BAR		4.1 BAR		5.5 BAR		6.9 BAR		8.3 BAR		9.7 BAR		11.0 BAR	
	LPM	HP	LPM	HP	LPM	HP	LPM	HP	LPM	HP	LPM	HP	LPM	HP	LPM	HP
3000	625	11.4	621	11.7	583	11.6	394	9.5								
3400	662	14.8	662	15.5	655	16.3	636	16.3	481	14.2	163	8.7				
3800	681	18.2	681	18.8	681	19.8	674	21.1	655	21.8	591	20.7	424	17.5		
4200	681	21.9	681	22.0	681	24.0	681	25.3	681	26.9	670	27.9	655	28.1	594	26.4

Viton® is a registered trademark of DuPont. Hypro® is a registered trademark of Pentair.

PEDESTAL MOUNT, CAST IRON, SELF-PRIMING

Series 9205C-SP



UPGRADE OPTIONS:

- ◆ Increase dry-run and abrasive resistance with Life Guard Seals
 - Life Guard seals are the OEM standard

FEATURES:

- ◆ Pedestal mount, direct drive
- ◆ Port sizes:
 - 2" NPT inlet, 2" NPT outlet (9205C-SP)
 - 2" BSP inlet, 2" BSP outlet (9205C-BSP)
- ◆ Max. fluid temperature: 140°F/60°C
- ◆ Housing: Cast iron
- ◆ Impeller: Nylon
- ◆ Pump shaft rotation: Counter clockwise when looking at the shaft end
- ◆ Pump seals: Viton®/ceramic standard; Life Guard silicon carbide (B) available
- ◆ Life Guard seals are the industry standard on OEM equipment
- ◆ Weight: 48 lbs./21.8 kg

ORDER INFORMATION

Model Number	Max GPM	Max LPM	Max PSI	Max BAR	Max RPM	Shaft Output
9205C-SP	160	606	145	10.0	3800	7/8" (22.2 mm) solid keyed shaft
9205C-BSP	160	606	145	10.0	3800	7/8" (22.2 mm) solid keyed shaft
3430-0537						Seal and o-ring repair kit
3430-0646						Life Guard silicon carbide seal kit
3430-0481SP						Self priming chamber kit
2526-0011						Clutch/single groove
3430-0481BSP						Self priming chamber kit (BSP)

Life Guard silicon carbide seal - Add suffix "B" (i.e.: 9205C-SP-B)

9205C-SP, 9205C-BSP

U.S. UNITS

RPM	GPM at 40 PSI	GPM at 50 PSI	GPM at 60 PSI	GPM at 70 PSI	GPM at 80 PSI	GPM at 90 PSI	GPM at 100 PSI	GPM at 110 PSI	GPM at 120 PSI	GPM at 130 PSI	GPM at 140 PSI
3400	155	154	153	150	131	110	84	35			
3600	158	157	156	155	153	137	114	88	58		
3800	160	159	158	157	156	155	142	123	102	74	28

9205C-SP, 9205C-BSP

METRIC UNITS

RPM	LPM at 2.8 BAR	LPM at 3.4 BAR	LPM at 4.1 BAR	LPM at 4.8 BAR	LPM at 5.5 BAR	LPM at 6.2 BAR	LPM at 6.9 BAR	LPM at 7.6 BAR	LPM at 8.3 BAR	LPM at 8.9 BAR	LPM at 9.7 BAR
3400	587	583	579	568	496	416	318	132			
3600	598	594	591	587	579	518	432	333	220		
3800	606	602	598	594	591	587	538	466	383	280	106

PEDESTAL MOUNT, CAST IRON & STAINLESS STEEL

Series 9206C and 9206S



UPGRADE OPTIONS:

- ◆ Increase dry-run and abrasive resistance with Life Guard Seals
 - Life Guard seals are the OEM standard
- ◆ Extend pump life with Stainless Steel
 - Fact: Chemical corrosion, pump cavitation, and abrasive wear are key factors in pump life
 - 316 Stainless Steel pumps provide superior chemical corrosion resistance, while maintaining material strength to prolong the life against abrasive wear
 - 316 Stainless Steel resists cavitation pitting of pumps, extending the wear life
 - Drop in replacements for cast iron pumps

FEATURES:

- ◆ Available in cast iron and 316 stainless steel for extended pump life
- ◆ Pedestal mount, direct drive
- ◆ Port sizes: 2" NPT inlet, 1-1/2" NPT outlet
- ◆ 220 x 220 (U) and 300 x 220 (-3U models) universal flange available
- ◆ Max. fluid temperature: 140°F/60°C
- ◆ Impeller: Nylon (standard in cast iron); polypropylene (standard in stainless steel); GTX available
- ◆ Pump shaft rotation: Counter clockwise when looking at the shaft end
- ◆ Pump seals: Cast Iron models - Viton®/ceramic standard; Life Guard silicon carbide (B) available; Stainless Steel models - Life Guard silicon carbide standard
- ◆ Life Guard seals are the industry standard on OEM equipment
- ◆ Weight: 23 lbs./10.5 kg

FOR FLANGED CONNECTIONS YOU WILL ALSO NEED:

- Universal Flange Gasket
- Universal Flange Clamp

See 251 for details

ORDER INFORMATION

Model Number	Max GPM	Max LPM	Max PSI	Max BAR	Max RPM	Shaft Output
9206C*	225	852	80	5.5	4200	5/8" (15.9 mm) solid shaft
9206S	225	852	80	5.5	4200	5/8" (15.9 mm) stainless steel shaft
3430-0332	Seal and o-ring repair kit					
3430-0589	Life Guard silicon carbide seal kit					

*Universal Flange (220 x 220) - Add Suffix "U" (i.e.: 9206C-U),
 Universal Flange (300 x 220) - Add Suffix "3U" (i.e.: 9206C-3U),
 Life Guard silicon carbide seal - Add suffix "B" (i.e.: 9206C-B)

9206C, 9206S, 9206C-U, 9206S-3U

U.S. UNITS

RPM	10 PSI		20 PSI		30 PSI		40 PSI		50 PSI		60 PSI		70 PSI		80 PSI	
	GPM	HP	GPM	HP	GPM	HP	GPM	HP	GPM	HP	GPM	HP	GPM	HP	GPM	HP
2400	171	2.3	114	2.0												
3600	225	7.0	225	7.1	225	7.5	196	7.3	143	6.1						
4200	225	9.2	225	9.4	225	10.7	225	11.0	225	11.3	202	10.9	158	9.5	80	6.4

9206C, 9206S, 9206C-U, 9206S-3U

METRIC UNITS

RPM	0.7 BAR		1.4 BAR		2.1 BAR		2.8 BAR		3.4 BAR		4.1 BAR		4.8 BAR		5.5 BAR	
	LPM	HP	LPM	HP	LPM	HP	LPM	HP	LPM	HP	LPM	HP	LPM	HP	LPM	HP
2400	647	2.3	432	2.0												
3600	852	7.0	852	7.1	852	7.5	742	7.3	541	6.1						
4200	852	9.2	852	9.4	852	10.7	852	11.0	852	11.3	765	10.9	598	9.5	303	6.4

PEDESTAL MOUNT, CAST IRON

Series 9208



FEATURES:

- ◆ 5" ANSI-flanged inlet x 4" ANSI-flanged outlet
- ◆ 316 stainless steel impeller for superior corrosion resistance
- ◆ 9208 version includes a solid 416 stainless steel shaft for corrosion resistance
- ◆ The 9208 shaft diameter is 1.63" (41.3 mm) to allow direct coupling to electric motors
- ◆ Life Guard silicon carbide seal for premium abrasion resistance and dry run protection
- ◆ Life Guard seals are the industry standard on OEM equipment
- ◆ Pump shaft rotation: Counter clockwise when looking at the shaft end

ORDER INFORMATION

Model Number	Max GPM	Max LPM	Max PSI	Max BAR	Max RPM	Shaft Output
9208C	1400	5300	85	5.9	3000	1-5/8" (41.3 mm) solid keyed Stainless Steel shaft
						Life Guard silicon carbide seal kit

9208C U.S. UNITS

RPM	20 PSI		40 PSI		60 PSI	
	GPM	HP	GPM	HP	GPM	HP
1750	607	10.8				
2500	1071	32.3	852	31.0	474	24.4
2750	1052	38.5	1027	42.0	788	38.2

9208C METRIC UNITS

RPM	1.4 BAR		2.8 BAR		4.1 BAR	
	LPM	HP	LPM	HP	LPM	HP
1750	2298	10.8				
2500	4054	32.3	3225	31.0	1794	24.4
2750	3982	38.5	3888	42.0	2983	38.2

PEDESTAL MOUNT, POLYPROPYLENE

Series 9203P-S



UPGRADE OPTIONS:

- ◆ Increase abrasive resistance with Life Guard Seals
 - Life Guard seals are the OEM standard

FEATURES:

- ◆ Pedestal mount
- ◆ For belt and pulley drive
- ◆ Port sizes: 1-1/2" NPT inlet, 1-1/4" NPT outlet
- ◆ Max. fluid temperature: 140°F/60°C
- ◆ Housing: Polypropylene
- ◆ Impeller: Polypropylene
- ◆ Pump shaft rotation: Counter clockwise 9203P-S, when looking at the shaft end; 9203P-SR is clockwise
- ◆ Pump seals: Viton®/ceramic standard; Life Guard silicon carbide (B) available
- ◆ Life Guard seals are the industry standard on OEM equipment
- ◆ Weight: 14 lbs./6.4 kg

ORDER INFORMATION

Model Number	Max GPM	Max LPM	Max PSI	Max BAR	Max RPM	Shaft Output
9203P-S	100	379	82	5.7	4200	7/8" (22.2 mm) solid keyed stainless steel shaft
9203P-SR	100	379	82	5.7	4200	7/8" (22.2 mm) solid keyed stainless steel shaft
3430-0333	Seal and o-ring repair kit					
3430-0590	Life Guard silicon carbide seal kit					

Life Guard silicon carbide seal - Add suffix "B" (i.e.: 9203P-S-B)

9203P-S, 9203P-SR

U.S. UNITS

RPM	10 PSI		20 PSI		30 PSI		40 PSI		50 PSI		60 PSI		70 PSI		80 PSI	
	GPM	HP	GPM	HP	GPM	HP	GPM	HP	GPM	HP	GPM	HP	GPM	HP	GPM	HP
2400	55	1.5	49	1.4	32	1.1										
3600	89	4.4	87	4.3	81	4.1	71	3.9	58	3.6	37	3.1				
4200	100	6.7	100	6.6	97	6.5	90	6.3	82	6.0	71	5.7	60	5.2	39	4.4

9203P-S, 9203P-SR

METRIC UNITS

RPM	0.7 BAR		1.4 BAR		2.1 BAR		2.8 BAR		3.4 BAR		4.1 BAR		4.8 BAR		5.5 BAR	
	LPM	HP	LPM	HP	LPM	HP	LPM	HP	LPM	HP	LPM	HP	LPM	HP	LPM	HP
2400	208	1.5	185	1.4	121	1.1										
3600	337	4.4	329	4.3	307	4.1	269	3.9	220	3.6	140	3.1				
4200	379	6.7	379	6.6	367	6.5	341	6.3	310	6.0	269	5.7	227	5.2	148	4.4

FLANGE MOUNT, POLYPROPYLENE

Series 9213P



UPGRADE OPTIONS:

- ◆ Increase abrasive resistance with Life Guard Seals
 - Life Guard seals are the OEM standard

FEATURES:

- ◆ Mounts clockwise rotation (when looking at the shaft end) – for direct mount to gasoline engines
- ◆ Shaft: 3/4" (19 mm) hollow, 416 stainless steel
- ◆ Port size: 1-1/2" NPT inlet, 1-1/4" NPT outlet
- ◆ Max. fluid temperature: 140°F/60°C
- ◆ Housing: Polypropylene
- ◆ Impeller: Polypropylene
- ◆ Flange bolt pattern for 5 hp gas engine
- ◆ Pump seals: Viton®/ceramic standard; Life Guard silicon carbide (B) available
- ◆ Life Guard seals are the industry standard on OEM equipment
- ◆ Weight: 19 lbs./8.6 kg

ORDER INFORMATION

Model Number	Max GPM	Max LPM	Max PSI	Max BAR	Max RPM	PTO Output
9213P	91	344	65	4.5	3600	3/4" hollow keyed stainless steel shaft for direct coupling to 5hp engine
3430-0333						Seal and o-ring repair kit
3430-0590						Life Guard silicon carbide seal kit

Life Guard silicon carbide seal - Add suffix "B" (i.e.: 9213P-B)

9213P – BASED ON 5.5 HP HONDA® ENGINE U.S. UNITS

GPM at 0 PSI	GPM at 10 PSI	GPM at 20 PSI	GPM at 30 PSI	GPM at 40 PSI	GPM at 50 PSI	GPM at 60 PSI
92	91	88	81	70	58	42

9213P – BASED ON 5.5 HP HONDA® ENGINE METRIC UNITS

LPM at 0.0 BAR	LPM at 0.7 BAR	LPM at 1.4 BAR	LPM at 2.1 BAR	LPM at 2.8 BAR	LPM at 3.4 BAR	LPM at 4.1 BAR
348	344	333	307	265	220	159

PEDESTAL MOUNT, CLUTCH-DRIVEN, POLYPROPYLENE

Series 9260P



UPGRADE OPTIONS:

- ◆ Increase dry-run and abrasive resistance with Life Guard Seals
 - Life Guard seals are the OEM standard

FEATURES:

- ◆ Pedestal mount with DC clutch drive
- ◆ Port sizes: 1-1/2" NPT inlet, 1-1/4" NPT outlet
- ◆ Max. fluid temperature: 140°F/60°C
- ◆ Housing: Polypropylene
- ◆ Impeller: Polypropylene
- ◆ Pump shaft rotation: Counter clockwise 9260P, when looking at the shaft end; 9260P-R is clockwise
- ◆ Pump seals: Viton®/ceramic standard; Life Guard silicon carbide (B) available
- ◆ Life Guard seals are the industry standard on OEM equipment
- ◆ Clutch: 12 volt with 5-1/2" (140 mm) diameter A-section pulley (part # 2526-0011)
- ◆ Weight: 19 lbs./8.6 kg

ORDER INFORMATION

Model Number	Max GPM	Max LPM	Max PSI	Max BAR	Max RPM	Rotation
9260P	100	379	82	5.7	4200	CCW
9260P-R	100	379	82	5.7	4200	CW
3430-0333	Seal and o-ring repair kit					
3430-0590	Life Guard silicon carbide seal kit					

Life Guard silicon carbide seal - Add suffix "B" (i.e.: 9260P-B)

9260P, 9260P-R

U.S. UNITS

RPM	10 PSI		20 PSI		30 PSI		40 PSI		50 PSI		60 PSI		70 PSI		80 PSI	
	GPM	HP	GPM	HP	GPM	HP	GPM	HP	GPM	HP	GPM	HP	GPM	HP	GPM	HP
2400	55	1.5	49	1.4	32	1.1										
3600	89	4.4	87	4.3	81	4.1	71	3.9	58	3.6	37	3.1				
4200	100	6.7	100	6.6	97	6.5	90	6.3	82	6.0	71	5.7	60	5.2	39	4.4

9260P, 9260P-R

METRIC UNITS

RPM	0.7 BAR		1.4 BAR		2.1 BAR		2.8 BAR		3.4 BAR		4.1 BAR		4.8 BAR		5.5 BAR	
	LPM	HP	LPM	HP	LPM	HP	LPM	HP	LPM	HP	LPM	HP	LPM	HP	LPM	HP
2400	208	1.5	185	1.4	121	1.1										
3600	337	4.4	329	4.3	307	4.1	269	3.9	220	3.6	140	3.1				
4200	379	6.7	379	6.6	367	6.5	341	6.3	310	6.0	269	5.7	227	5.2	148	4.4

PEDESTAL MOUNT, CLUTCH-DRIVEN, CAST IRON & STAINLESS STEEL

Series 9262C-C and 9262S-C



UPGRADE OPTIONS:

- ◆ Increase dry-run and abrasive resistance with Life Guard Seals
 - Life Guard seals are the OEM standard
- ◆ Extend pump life with Stainless Steel
 - Fact: Chemical corrosion, pump cavitation, and abrasive wear are key factors in pump life
 - 316 Stainless Steel pumps provide superior chemical corrosion resistance, while maintaining material strength to prolong the life against abrasive wear
 - 316 Stainless Steel resists cavitation pitting of pumps, extending the wear life
 - Drop in replacements for cast iron pumps

FEATURES:

- ◆ Pedestal mount with DC clutch drive
- ◆ Double "A" groove pulley (5"/125 mm diameter)
- ◆ Port sizes: 1-1/4" NPT inlet, 1" NPT outlet
- ◆ Max. fluid temperature: 140°F/60°C
- ◆ Available in cast iron and 316 stainless steel for extended pump life
- ◆ Impeller: Nylon (standard in cast iron); polypropylene (standard in stainless steel); GTX available
- ◆ Pump shaft rotation: Counter clockwise when looking at the shaft end; Clockwise for -CR models
- ◆ Pump seals: Cast Iron models - Viton®/ceramic standard; Life Guard silicon carbide (B) available; Stainless Steel models (Life Guard silicon carbide standard)
 - Life Guard seals are the industry standard on OEM equipment
- ◆ 3.75 Amp draw (45 watts at 12 volts)
- ◆ Weight: 23 lbs./10.5 kg

ORDER INFORMATION

Model Number	Max GPM	Max LPM	Max PSI	Max PSI	Max RPM	Rotation
9262C-C	88	333	114	7.9	5000	CCW*
9262S-C	145	549	114	7.9	5000	CCW*
9262S-CR	145	549	114	7.9	5000	CW*
3430-0332	Seal and o-ring repair kit					
3430-0589	Life Guard silicon carbide seal kit					

Life Guard silicon carbide seal - Add suffix "B" (i.e.: 9262C-CB) *CCW (counterclockwise) CW (clockwise) are determined when looking at the shaft end.

9262C-C

U.S. UNITS

RPM	10 PSI		20 PSI		40 PSI		60 PSI		80 PSI		100 PSI	
	GPM	HP	GPM	HP	GPM	HP	GPM	HP	GPM	HP	GPM	HP
2400	50	1.3	46	1.2								
3600	67	3.7	66	3.7	62	3.5	25	2.8				
4200	75	5.7	75	5.7	75	5.7	66	5.3	40	4.6		
5000	88	9.3	88	9.3	88	9.3	88	9.3	77	8.6	60	7.5

9262C-C

METRIC UNITS

RPM	0.7 BAR		1.4 BAR		2.8 BAR		4.1 BAR		5.5 BAR		6.9 BAR	
	LPM	HP	LPM	HP	LPM	HP	LPM	HP	LPM	HP	LPM	HP
2400	189	1.3	174	1.2								
3600	254	3.7	250	3.7	235	3.5	95	2.8				
4200	284	5.7	284	5.7	284	5.7	250	5.3	151	4.6		
5000	333	9.3	333	9.3	333	9.3	333	9.3	291	8.6	227	7.5

9262S-C, 9262S-CR

U.S. UNITS

RPM	10 PSI		20 PSI		40 PSI		60 PSI		80 PSI		100 PSI	
	GPM	HP	GPM	HP	GPM	HP	GPM	HP	GPM	HP	GPM	HP
2400	73	1.4	55	1.2								
3600	112	4.5	109	4.5	86	4.0	25	2.8				
4200	128	7.1	127	7.1	116	6.8	92	6.1	40	4.6		
5000	145	11.8	145	11.8	143	11.7	133	11.3	115	10.4	86	9.1

9262S-C, 9262S-CR

METRIC UNITS

RPM	0.7 BAR		1.4 BAR		2.8 BAR		4.1 BAR		5.5 BAR		6.9 BAR	
	LPM	HP	LPM	HP	LPM	HP	LPM	HP	LPM	HP	LPM	HP
2400	276	1.4	208	1.2								
3600	424	4.5	413	4.5	326	4.0	95	2.8				
4200	484	7.1	481	7.1	439	6.8	348	6.1	151	4.6		
5000	549	11.8	549	11.8	541	11.7	503	11.3	435	10.4	326	9.1

Viton® is a registered trademark of DuPont. Hypro® is a registered trademark of Pentair.

PEDESTAL MOUNT, CLUTCH-DRIVEN, CAST IRON & STAINLESS STEEL, SELF-PRIMING

Series 9263C-SP and 9263S-SP



UPGRADE OPTIONS:

- ◆ Increase dry-run and abrasive resistance with Life Guard Seals
 - Life Guard seals are the OEM standard
- ◆ Extend pump life with Stainless Steel
 - Fact: Chemical corrosion, pump cavitation, and abrasive wear are key factors in pump life
 - 316 Stainless Steel pumps provide superior chemical corrosion resistance, while maintaining material strength to prolong the life against abrasive wear
 - 316 Stainless Steel resists cavitation pitting of pumps, extending the wear life
 - Drop in replacements for cast iron pumps

FEATURES:

- ◆ Available in cast iron and 316 stainless steel for extended pump life
- ◆ Double "A" groove pulley (5"/125 mm diameter)
- ◆ Pedestal mount with DC clutch drive
- ◆ Max fluid temperature: 140° F/60° C
- ◆ Impeller: Nylon (standard in cast iron); polypropylene (standard in stainless steel); GTX available
- ◆ Pump seals: Cast Iron models - Viton®/ceramic standard; Life Guard silicon carbide (B) available; Stainless Steel models (Life Guard silicon carbide standard)
- ◆ Life Guard seals are the industry standard on OEM equipment
- ◆ 3.75 Amp draw (45 watts at 12 volts)

ORDER INFORMATION

Model Number	Max GPM	Max LPM	Max PSI	Max BAR	Max RPM	Rotation	Port Sizes
9263C-CR-SP	127	481	110	7.6	5000	CW*	2" NPT inlet x 2" NPT outlet
9263C-CR-SP-B	127	481	110	7.6	5000	CW*	2" NPT inlet x 2" NPT outlet
9263C-C-SP	120	454	110	7.6	5000	CCW*	1-1/2" NPT inlet x 1-1/4" NPT outlet
9263S-C-SP	120	454	110	7.6	5000	CCW*	1-1/2" NPT inlet x 1-1/4" NPT outlet
3430-0332	Seal and o-ring repair kit						
3430-0589	Life Guard silicon carbide seal kit						

Life Guard silicon carbide seal - Add suffix "B" (i.e.: 9263-CR-SP-B) *CCW (counterclockwise) CW (clockwise) are determined when looking at the shaft end.

9263C-CR-SP, 9263C-CR-SP-B

U.S. UNITS

RPM	20 PSI		30 PSI		40 PSI		50 PSI		60 PSI		70 PSI		80 PSI		90 PSI		100 PSI		
	GPM	HP	GPM	HP	GPM	HP	GPM	HP	GPM	HP	GPM	HP	GPM	HP	GPM	HP	GPM	HP	
3600	80	3.8	64	3.4	43	2.9	17	2.6											
4200	102	6.1	90	5.8	76	5.4	59	4.7	38	4.0	16	3.7							
5000	127	10.5	119	10.2	109	9.8	99	9.3	86	8.7	70	7.9	55	7.2	37	6.2	18	5.4	

9263C-CR-SP, 9263C-CR-SP-B

METRIC UNITS

RPM	1.4 BAR		2.1 BAR		2.8 BAR		3.4 BAR		4.1 BAR		4.8 BAR		5.5 BAR		6.2 BAR		6.9 BAR		
	LPM	HP	LPM	HP	LPM	HP	LPM	HP	LPM	HP	LPM	HP	LPM	HP	LPM	HP	LPM	HP	
3600	303	3.8	242	3.4	163	2.9	64	2.6											
4200	386	6.1	341	5.8	288	5.4	223	4.7	144	4.0	61	3.7							
5000	481	10.5	450	10.2	413	9.8	375	9.3	326	8.7	265	7.9	208	7.2	140	6.2	68	5.4	

9263C-C-SP, 9263S-C-SP

U.S. UNITS

RPM	20 PSI		30 PSI		40 PSI		50 PSI		60 PSI		70 PSI		80 PSI		90 PSI		100 PSI		
	GPM	HP	GPM	HP	GPM	HP	GPM	HP	GPM	HP	GPM	HP	GPM	HP	GPM	HP	GPM	HP	
3600	101	4.2	84	3.9	60	3.4	25	2.6											
4200	118	6.7	112	6.7	97	6.1	79	5.5	54	4.7	23	4.0							
5000	120	10.1	120	10.3	119	10.3	117	10.2	110	10.1	96	9.6	78	8.7	52	7.2	25	5.8	

9263C-C-SP, 9263S-C-SP

METRIC UNITS

RPM	1.4 BAR		2.1 BAR		2.8 BAR		3.4 BAR		4.1 BAR		4.8 BAR		5.5 BAR		6.2 BAR		6.9 BAR		
	LPM	HP	LPM	HP	LPM	HP	LPM	HP	LPM	HP	LPM	HP	LPM	HP	LPM	HP	LPM	HP	
3600	382	4.2	318	3.9	227	3.4	95	2.6											
4200	447	6.7	424	6.7	367	6.1	299	5.5	204	4.7	87	4.0							
5000	454	10.1	454	10.3	450	10.3	443	10.2	416	10.1	363	9.6	295	8.7	197	7.2	95	5.8	

Viton® is a registered trademark of DuPont. Hypro® is a registered trademark of Pentair.

PEDESTAL MOUNT, CLUTCH-DRIVEN, CAST IRON & STAINLESS STEEL

Series 9263C-C and 9263S-C



UPGRADE OPTIONS:

- ◆ Increase dry-run and abrasive resistance with Life Guard Seals
 - Life Guard seals are the OEM standard
- ◆ Extend pump life with Stainless Steel
 - Fact: Chemical corrosion, pump cavitation, and abrasive wear are key factors in pump life
 - 316 Stainless Steel pumps provide superior chemical corrosion resistance, while maintaining material strength to prolong the life against abrasive wear
 - 316 Stainless Steel resists cavitation pitting of pumps, extending the wear life
 - Drop in replacements for cast iron pumps

FEATURES:

- ◆ Available in cast iron and 316 stainless steel for extended pump life
- ◆ Pedestal mount with DC clutch drive
- ◆ Double "A" groove pulley (5"/125 mm diameter)
- ◆ Port sizes: 1-1/2" NPT inlet, 1-1/4" NPT outlet (BSP available on 9263C)
- ◆ 220 x 200 universal flange available (U)
- ◆ Max. fluid temperature: 140°F/60°C
- ◆ Impeller: Nylon (standard in cast iron); polypropylene (standard in stainless steel); GTX available
- ◆ Pump seals: Cast Iron models - Viton®/ceramic standard; Life Guard silicon carbide (B) available; Stainless Steel models - Life Guard silicon carbide standard
- ◆ Life Guard seals are the industry standard on OEM equipment
- ◆ 3.75 Amp draw (45 watts at 12 volts)
- ◆ Weight: 23 lbs./10.5 kg

FOR FLANGED CONNECTIONS YOU WILL ALSO NEED:

- Universal Flange Gasket Universal Flange Clamp
See 251 for details

ORDER INFORMATION

Model Number	Max GPM	Max LPM	Max PSI	Max BAR	Max RPM	Rotation
9263C-C †(BSP Version - 9263C-BT)	140	530	114	7.9	5000	CCW*
9263C-CR	140	530	114	7.9	5000	CW*
9263S-C †	140	530	114	7.9	5000	CCW*
9263S-CR	140	530	114	7.9	5000	CW*
3430-0332	Seal and o-ring repair kit					
3430-0589	Life Guard silicon carbide seal kit					

† Universal Flange (220 x 200) - Add Suffix "U" (i.e.: 9263C-C-U)

Life Guard silicon carbide seal - Add suffix "B" (i.e.: 9263C-CB)

*CCW (counterclockwise) CW (clockwise) are determined when looking at the shaft end.

9263C-C, 9263S-C, 9263C-CR, 9263S-CR, 9263C-C-U, 9263S-C-U

U.S. UNITS

RPM	10 PSI		20 PSI		40 PSI		60 PSI		80 PSI		100 PSI	
	GPM	HP	GPM	HP	GPM	HP	GPM	HP	GPM	HP	GPM	HP
2400	80	1.9	65	1.8								
3600	105	5.3	105	5.3	92	5.0	50	3.7				
4200	122	8.2	120	7.9	115	7.7	98	7.1	56	5.3		
5000	140	12.6	140	12.6	138	12.6	130	12.2	118	11.6	88	9.9

9263C-C, 9263S-C, 9263C-CR, 9263S-CR, 9263C-C-U, 9263S-C-U

METRIC UNITS

RPM	0.7 BAR		1.4 BAR		2.8 BAR		4.1 BAR		5.5 BAR		6.9 BAR	
	LPM	HP	LPM	HP	LPM	HP	LPM	HP	LPM	HP	LPM	HP
2400	303	1.9	246	1.8								
3600	397	5.3	397	5.3	348	5.0	189	3.7				
4200	462	8.2	454	7.9	435	7.7	371	7.1	212	5.3		
5000	530	12.6	530	12.6	522	12.6	492	12.2	447	11.6	333	9.9

Viton® is a registered trademark of DuPont. Hypro® is a registered trademark of Pentair.

HYDRAULICALLY-DRIVEN, CAST IRON AND STAINLESS STEEL

Series 9302C and 9302S



UPGRADE OPTIONS:

- ◆ Increase dry-run and abrasive resistance with Life Guard Seals
 - Life Guard seals are the OEM standard
- ◆ Extend pump life with Stainless Steel
 - Fact: Chemical corrosion, pump cavitation, and abrasive wear are key factors in pump life
 - 316 Stainless Steel pumps provide superior chemical corrosion resistance, while maintaining material strength to prolong the life against abrasive wear
 - 316 Stainless Steel resists cavitation pitting of pumps, extending the wear life
 - Drop in replacements for cast iron pumps

FEATURES:

- ◆ Available in cast iron and 316 stainless steel for extended pump life
- ◆ Hydraulic motor drive (for open center, closed center and load-sensing systems)
- ◆ Port sizes: 1-1/4" NPT inlet, 1" NPT outlet
- ◆ Max. fluid temperature: 140°F/60°C
- ◆ Impeller: Cast Iron models - Nylon; Stainless Steel models - Polypropylene
- ◆ Motor: internal gear gerotor
- ◆ Hydraulic ports: 1/2" NPT inlet, 3/4" NPT outlet-HM Series
- ◆ Hydraulic ports on GM1 Series: 3/4" 16 UNF #8 SAE
- ◆ Pump seals: Cast Iron models - Viton®/ceramic standard; Life Guard silicon carbide (B) available; Stainless Steel models (Life Guard silicon carbide standard)
- ◆ Life Guard seals are the industry standard on OEM equipment
- ◆ Hydraulic motor seal: double-lip Teflon®
- ◆ Max. motor psi: 3000 (bar: 207)
- ◆ Weight: 26 lbs./11.8 kg

ORDER INFORMATION

Model Number	Max GPM	Max LPM	Max PSI	Max BAR	Max Hyd. GPM	Max Hyd. LPM	Hydraulic Selection System
9302CT-GM1	63	238	90	6.2	3	11.4	Open/Closed
9302C-HM1C	72	273	150	10.3	13	49.2	Open/Closed
9302C-HM2C	65	246	96	6.6	6	22.7	Open/Closed
9302C-HM4C	72	273	120	8.3	7	26.5	Open/Closed
9302ST-GM1	63	238	90	6.2	3	11.4	Open/Closed
9302S-HM1C	72	273	150	10.3	13	49.2	Open/Closed
9302S-HM2C	65	246	96	6.6	6	22.7	Open/Closed
9302S-HM4C	72	273	120	8.3	7	26.5	Open/Closed
3430-0332	Seal and o-ring repair kit						
3430-0589	Life Guard silicon carbide seal kit						

Life Guard silicon carbide seal - Add suffix "B" (i.e.: 9302CT-GM1-B)

HYDRAULICALLY-DRIVEN, CAST IRON AND STAINLESS STEEL

Series 9302C and 9302S

9302CT-GM1, 9302ST-GM1

U.S. UNITS

Hyd. Flow GPM	GPM at 10 PSI	GPM at 20 PSI	GPM at 30 PSI	GPM at 40 PSI	GPM at 50 PSI	GPM at 60 PSI	GPM at 70 PSI	GPM at 80 PSI	GPM at 90 PSI
2.0	51	48	39	21					
2.5	60	59	56	48	37	23			
3.0	63	63	62	61	58	50	39	25	0

9302CT-GM1, 9302ST-GM1

METRIC UNITS

Hyd. Flow LPM	LPM at 0.7 BAR	LPM at 1.4 BAR	LPM at 2.1 BAR	LPM at 2.8 BAR	LPM at 3.5 BAR	LPM at 4.2 BAR	LPM at 4.9 BAR	LPM at 5.6 BAR	LPM at 6.3 BAR
7.6	193	182	148	79					
9.5	227	223	212	182	140	87			
11.4	238	238	235	231	220	189	148	95	0

9302C-HM1C, 9302S-HM1C

U.S. UNITS

Hyd. Flow GPM	GPM at 40 PSI	GPM at 50 PSI	GPM at 60 PSI	GPM at 70 PSI	GPM at 80 PSI	GPM at 90 PSI	GPM at 100 PSI	GPM at 110 PSI	GPM at 120 PSI	GPM at 130 PSI	GPM at 140 PSI
11	72	72	71	65	56	45	29				
12	72	72	72	72	70	63	53	40			
13	72	72	72	72	72	71	68	63	56	48	35

9302C-HM1C, 9302S-HM1C

METRIC UNITS

Hyd. Flow LPM	LPM at 2.8 BAR	LPM at 3.4 BAR	LPM at 4.1 BAR	LPM at 4.8 BAR	LPM at 5.5 BAR	LPM at 6.2 BAR	LPM at 6.9 BAR	LPM at 7.6 BAR	LPM at 8.3 BAR	LPM at 9.0 BAR	LPM at 9.7 BAR
41.6	273	273	269	246	212	170	110				
45.4	273	273	273	273	265	238	201	151			
49.2	273	273	273	273	273	269	257	238	212	182	132

9302C-HM2C, 9302S-HM2C

U.S. UNITS

Hyd. Flow GPM	GPM at 10 PSI	GPM at 20 PSI	GPM at 30 PSI	GPM at 40 PSI	GPM at 50 PSI	GPM at 60 PSI	GPM at 70 PSI	GPM at 80 PSI	GPM at 90 PSI
4	54	49	42	34	19				
5	59	57	50	42	34	25	11		
6	64	63	60	52	44	36	27	18	9

9302C-HM2C, 9302S-HM2C

METRIC UNITS

Hyd. Flow LPM	LPM at 0.7 BAR	LPM at 1.4 BAR	LPM at 2.1 BAR	LPM at 2.8 BAR	LPM at 3.4 BAR	LPM at 4.1 BAR	LPM at 4.8 BAR	LPM at 5.5 BAR	LPM at 6.2 BAR
15.1	204	185	159	129	72				
18.9	223	216	189	159	129	95	42		
22.7	244	238	227	197	167	136	102	68	34

9302C-HM4C, 9302S-HM4C

U.S. UNITS

Hyd. Flow GPM	GPM at 10 PSI	GPM at 20 PSI	GPM at 30 PSI	GPM at 40 PSI	GPM at 50 PSI	GPM at 60 PSI	GPM at 70 PSI	GPM at 80 PSI	GPM at 90 PSI	GPM at 100 PSI	GPM at 110 PSI
6	65	63	59	51	41	29	12				
7	72	72	71	67	60	51	42	31	17		
8	72	72	72	72	70	64	57	50	42	32	16

9302C-HM4C, 9302S-HM4C

METRIC UNITS

Hyd. Flow LPM	LPM at 0.7 BAR	LPM at 1.4 BAR	LPM at 2.1 BAR	LPM at 2.8 BAR	LPM at 3.4 BAR	LPM at 4.1 BAR	LPM at 4.8 BAR	LPM at 5.5 BAR	LPM at 6.2 BAR	LPM at 6.9 BAR	LPM at 7.6 BAR
22.7	246	238	223	193	155	110	45				
26.5	273	273	269	254	227	193	159	117	64		
30.3	273	273	273	273	265	242	216	189	159	121	61

HYDRAULICALLY-DRIVEN, CAST IRON & STAINLESS STEEL

Series 9303C and 9303S



UPGRADE OPTIONS:

- ◆ Increase dry-run and abrasive resistance with Life Guard Seals
 - Life Guard seals are the OEM standard
- ◆ Extend pump life with Stainless Steel
 - Fact: Chemical corrosion, pump cavitation, and abrasive wear are key factors in pump life
 - 316 Stainless Steel pumps provide superior chemical corrosion resistance, while maintaining material strength to prolong the life against abrasive wear
 - 316 Stainless Steel resists cavitation pitting of pumps, extending the wear life
 - Drop in replacements for cast iron pumps

FEATURES:

- ◆ Hydraulic motor drive (for open center, closed center and load-sensing systems)
- ◆ Port sizes: 1-1/2" NPT inlet, 1-1/4" NPT outlet
- ◆ 220 x 200 universal flange available (U)
- ◆ Max. fluid temperature: 140°F/60°C
- ◆ Impeller: Cast Iron models - Nylon; (GTX available)
Stainless Steel models - Polypropylene
- ◆ Motor: internal gear gerotor
- ◆ Hydraulic ports: 1/2" NPT inlet, 3/4" NPT outlet
- ◆ Pump seals: Cast Iron models - Viton®/ceramic standard; Life Guard silicon carbide (B) available;
Stainless Steel models - Life Guard silicon carbide standard
- ◆ Life Guard seals are the industry standard on OEM equipment
- ◆ Hydraulic motor seal: double-lip Teflon®
- ◆ Max. motor psi: 3000 (bar: 207)
- ◆ Weight: 26 lbs./11.8 kg

FOR FLANGED CONNECTIONS YOU WILL ALSO NEED:

- Universal Flange Gasket Universal Flange Clamp
See 251 for details

ORDER INFORMATION

Model Number	Max GPM	Max LPM	Max PSI	Max BAR	Max Hyd. GPM	Max Hyd. LPM	Hydraulic Selection System
9303C-HM1C	114	432	130	9.0	13	49.2	Open/Closed
9303C-HM2C	97	367	95	6.5	6	22.7	Open/Closed
9303C-HM3C	125	473	98	6.8	24	90.8	Open/Closed
9303C-HM4C	115	435	93	6.4	7	26.5	Open/Closed
9303C-HM5C	147	556	145	10.0	16	60.6	Open/Closed
9303S-HM1C	114	432	130	9.0	13	49.2	Open/Closed
9303S-HM2C	97	367	95	6.5	6	22.7	Open/Closed
9303S-HM3C	125	473	98	6.8	24	90.8	Open/Closed
9303S-HM4C	115	435	93	6.4	7	26.5	Open/Closed
9303S-HM5C	147	556	145	10.0	16	60.6	Open/Closed
3430-0332	Seal and o-ring repair kit						
3430-0589	Life Guard silicon carbide seal kit						

Universal Flange (220 x 200) - Add suffix "U" (i.e.: 9303C-HM3C-U)
Life Guard silicon carbide seal - Add suffix "B" (i.e.: 9303C-HM1C-B)

Teflon® is a registered trademark of E.I. DuPont de Nemours and Co.
Viton® is a registered trademark of DuPont. Hypro® is a registered trademark of Pentair.

HYDRAULICALLY-DRIVEN, CAST IRON & STAINLESS STEEL

Series 9303C and 9303S

9303C-HM1C, 9303S-HM1C

U.S. UNITS

Hyd. Flow GPM	GPM at 20 PSI	GPM at 30 PSI	GPM at 40 PSI	GPM at 50 PSI	GPM at 60 PSI	GPM at 70 PSI	GPM at 80 PSI	GPM at 90 PSI	GPM at 100 PSI	GPM at 110 PSI	GPM at 120 PSI
11	104	101	96	90	82	71	60	47	31		
12	110	109	107	105	101	92	81	67	53	36	9
13	112	111	109	107	104	102	96	85	76	63	33

9303C-HM1C, 9303S-HM1C

METRIC UNITS

Hyd. Flow LPM	LPM at 1.4 BAR	LPM at 2.1 BAR	LPM at 2.8 BAR	LPM at 3.4 BAR	LPM at 4.1 BAR	LPM at 4.8 BAR	LPM at 5.5 BAR	LPM at 6.2 BAR	LPM at 6.9 BAR	LPM at 7.6 BAR	LPM at 8.3 BAR
41.6	394	382	363	341	310	269	227	178	117		
45.4	416	413	405	397	382	348	307	254	201	136	34
49.2	424	420	413	405	394	386	363	322	288	238	125

9303C-HM2C, 9303S-HM2C

U.S. UNITS

Hyd. Flow GPM	GPM at 10 PSI	GPM at 20 PSI	GPM at 30 PSI	GPM at 40 PSI	GPM at 50 PSI	GPM at 60 PSI	GPM at 70 PSI	GPM at 80 PSI	GPM at 90 PSI
4	70	60	45	25					
5	83	74	65	50	37	22	4		
6	94	86	80	72	62	50	37	22	7

9303C-HM2C, 9303S-HM2C

METRIC UNITS

Hyd. Flow LPM	LPM at 0.7 BAR	LPM at 1.4 BAR	LPM at 2.1 BAR	LPM at 2.8 BAR	LPM at 3.4 BAR	LPM at 4.1 BAR	LPM at 4.8 BAR	LPM at 5.5 BAR	LPM at 6.2 BAR
15.1	265	227	170	95					
18.9	314	280	246	189	140	83	15		
22.7	356	326	303	273	235	189	140	83	26

9303C-HM3C, 9303S-HM3C

U.S. UNITS

Hyd. Flow GPM	GPM at 10 PSI	GPM at 20 PSI	GPM at 30 PSI	GPM at 40 PSI	GPM at 50 PSI	GPM at 60 PSI	GPM at 70 PSI	GPM at 80 PSI	GPM at 90 PSI
15	100	92	83	69	47				
18	116	114	108	100	90	76	55	33	
20	125	123	120	114	107	96	85	71	50

9303C-HM3C, 9303S-HM3C

METRIC UNITS

Hyd. Flow LPM	LPM at 0.7 BAR	LPM at 1.4 BAR	LPM at 2.1 BAR	LPM at 2.8 BAR	LPM at 3.4 BAR	LPM at 4.1 BAR	LPM at 4.8 BAR	LPM at 5.5 BAR	LPM at 6.2 BAR
56.8	379	348	314	261	178				
68.1	439	432	409	379	341	288	208	125	
75.7	473	466	454	432	405	363	322	269	189

9303C-HM4C, 9303S-HM4C

U.S. UNITS

Hyd. Flow GPM	GPM at 10 PSI	GPM at 20 PSI	GPM at 30 PSI	GPM at 40 PSI	GPM at 50 PSI	GPM at 60 PSI	GPM at 70 PSI	GPM at 80 PSI	GPM at 90 PSI
5	84	76	66	52	34				
6	97	92	86	78	67	50	25		
7	110	104	98	91	82	69	55	38	14

9303C-HM4C, 9303S-HM4C

METRIC UNITS

Hyd. Flow LPM	LPM at 0.7 BAR	LPM at 1.4 BAR	LPM at 2.1 BAR	LPM at 2.8 BAR	LPM at 3.4 BAR	LPM at 4.1 BAR	LPM at 4.8 BAR	LPM at 5.5 BAR	LPM at 6.2 BAR
18.9	318	288	250	197	129				
22.7	367	348	326	295	254	189	95		
26.5	416	394	371	344	310	261	208	144	53

9303C-HM5C, 9303S-HM5C

U.S. UNITS

Hyd. Flow GPM	GPM at 30 PSI	GPM at 40 PSI	GPM at 50 PSI	GPM at 60 PSI	GPM at 70 PSI	GPM at 80 PSI	GPM at 90 PSI	GPM at 100 PSI	GPM at 110 PSI	GPM at 120 PSI	GPM at 130 PSI
13	113	105	97	86	73	59	44				
14	128	123	116	108	98	88	74	61	44		
15	135	132	126	119	110	100	89	77	66	50	20
16	145	142	137	132	126	117	107	95	83	70	55

9303C-HM5C, 9303S-HM5C

METRIC UNITS

Hyd. Flow LPM	LPM at 2.1 BAR	LPM at 2.8 BAR	LPM at 3.4 BAR	LPM at 4.1 BAR	LPM at 4.8 BAR	LPM at 5.5 BAR	LPM at 6.2 BAR	LPM at 6.9 BAR	LPM at 7.6 BAR	LPM at 8.3 BAR	LPM at 9.0 BAR
49.2	428	397	367	326	276	223	167				
53.0	485	466	439	409	371	333	280	231	167		
56.8	511	500	477	450	416	379	337	291	250	189	76
60.6	549	538	519	500	477	443	405	360	314	265	208

FORCEFIELD, CAST IRON AND STAINLESS STEEL

Series 9313



UPGRADE OPTIONS:

- ◆ Extend pump life with Stainless Steel
 - Fact: Chemical corrosion, pump cavitation, and abrasive wear are key factors in pump life
 - 316 Stainless Steel pumps provide superior chemical corrosion resistance, while maintaining material strength to prolong life against abrasive wear
 - 316 Stainless Steel resists cavitation pitting of pumps, extending wear life
- ◆ Hydraulic motor with case drain for maximum motor life

FEATURES:

- ◆ ForceField Technology is a superior wet seal technology that provides the ultimate protection for the mechanical seal and avoids costly downtime
- ◆ Protects the mechanical seal against common failures related to dry run and chemical bonding by using a barrier fluid to keep it cool and lubricated
- ◆ Actively maintains a pressure differential between the barrier fluid and the pumping solution, which results in longer life and worry free operation.
- ◆ Capable of flows up to 197 GPM (746 LPM) and can produce up to 150 PSI (10.3 bar)
- ◆ Designed to be a drop-in replacement for standard Hypro hydraulically driven centrifugal pumps
- ◆ One year warranty covering pump, motor and seals

FOR FLANGED CONNECTIONS YOU WILL ALSO NEED:

- Universal Flange Gasket Universal Flange Clamp

See 251 for details

ORDER INFORMATION

Part Number	Current Product Equivalent	Inlet/Outlet	Max GPM	Max LPM	Max PSI	Max Bar	Max Hyd. GPM	Max Hyd. LPM
9313C-M04	9303C-HM2C	1-1/2" NPT x 1-1/4" NPT	140	530	90	6.2	7	26.5
9313CU-M04	9303C-HM2C-U	220 x 200 Universal Flange	140	530	90	6.2	7	26.5
9313C-M05	9303C-HM4C	1-1/2" NPT x 1-1/4" NPT	155	587	100	6.9	8	30.3
9313CU-M05	9303C-HM4C-U	220 x 200 Universal Flange	155	587	100	6.9	8	30.3
9313C-M08	9303C-HM1C	1-1/2" NPT x 1-1/4" NPT	188	712	137	9.4	13	49.2
9313CU-M08	9303C-HM1C-U	220 x 200 Universal Flange	188	712	137	9.4	13	49.2
9313C-M10	9303C-HM5C	1-1/2" NPT x 1-1/4" NPT	197	746	150	10.3	16	60.6
9313CU-M10	9303C-HM5C-U	220 x 200 Universal Flange	197	746	150	10.3	16	60.6
9313C-M16	9303C-HM3C	1-1/2" NPT x 1-1/4" NPT	194	734	103	7.1	20	75.7
9313CU-M16	9303C-HM3C-U	220 x 200 Universal Flange	194	734	103	7.1	20	75.7
9313S-M04	9303S-HM2C	1-1/2" NPT x 1-1/4" NPT	140	530	90	6.2	7	26.5
9313SU-M04	9303S-HM2C-U	220 x 200 Universal Flange	140	530	90	6.2	7	26.5
9313S-M05	9303S-HM4C	1-1/2" NPT x 1-1/4" NPT	155	587	100	6.9	8	30.3
9313SU-M05	9303S-HM4C-U	220 x 200 Universal Flange	155	587	100	6.9	8	30.3
9313S-M08	9303S-HM1C	1-1/2" NPT x 1-1/4" NPT	188	712	137	9.4	13	49.2
9313SU-M08	9303S-HM1C-U	220 x 200 Universal Flange	188	712	137	9.4	13	49.2
9313S-M10	9303S-HM5C	1-1/2" NPT x 1-1/4" NPT	197	746	150	10.3	16	60.6
9313SU-M10	9303S-HM5C-U	220 x 200 Universal Flange	197	746	150	10.3	16	60.6
9313S-M16	9303S-HM3C	1-1/2" NPT x 1-1/4" NPT	194	734	103	7.1	20	75.7
9313SU-M16	9303S-HM3C-U	220 x 200 Universal Flange	194	734	103	7.1	20	75.7

Case Drain motor available - Add suffix "Y" (i.e. 9313CU-M08Y)

9313C-M04, 9313CU-M04, 9313S-M04, 9313SU-M04

U.S. UNITS

Hyd. Flow GPM	GPM at 10 PSI	GPM at 20 PSI	GPM at 30 PSI	GPM at 40 PSI	GPM at 50 PSI	GPM at 60 PSI	GPM at 70 PSI	GPM at 80 PSI
5	128	111	85	60	36	15		
6	134*	120	97	74	55	36	18	
7	140*	127	104	83	64	45	29	14

9313C-M04, 9313CU-M04, 9313S-M04, 9313SU-M04

METRIC UNITS

Hyd. Flow LPM	LPM at 0.7 BAR	LPM at 1.4 BAR	LPM at 2.1 BAR	LPM at 2.8 BAR	LPM at 3.4 BAR	LPM at 4.1 BAR	LPM at 4.8 BAR	LPM at 5.5 BAR
18.9	485	420	322	227	136	57		
22.7	507*	454	367	280	208	136	68	
26.5	530*	481	394	314	242	170	110	53

FORCEFIELD, CAST IRON AND STAINLESS STEEL

Series 9313

9313C-M05, 9313CU-M05, 9313S-M05, 9313SU-M05

U.S. UNITS

Hyd. Flow GPM	GPM at 10 PSI	GPM at 20 PSI	GPM at 30 PSI	GPM at 40 PSI	GPM at 50 PSI	GPM at 60 PSI	GPM at 70 PSI	GPM at 80 PSI	GPM at 90 PSI
6	144*	130	106	82	58	30			
7	150*	138	119	96	75	55	34	14	
8	155*	145*	130	108	88	70	52	35	17

9313C-M05, 9313CU-M05, 9313S-M05, 9313SU-M05

METRIC UNITS

Hyd. Flow LPM	LPM at 0.7 BAR	LPM at 1.4 BAR	LPM at 2.1 BAR	LPM at 2.8 BAR	LPM at 3.4 BAR	LPM at 4.1 BAR	LPM at 4.8 BAR	LPM at 5.5 BAR	LPM at 6.2 BAR
22.7	545*	492	401	310	220	114			
26.5	568*	522*	450	363	284	208	129	53	
30.3	587*	549*	492	409	333	265	197	132	64

9313C-M08, 9313CU-M08, 9313S-M08, 9313SU-M08

U.S. UNITS

Hyd. Flow GPM	GPM at 20 PSI	GPM at 30 PSI	GPM at 40 PSI	GPM at 50 PSI	GPM at 60 PSI	GPM at 70 PSI	GPM at 80 PSI	GPM at 90 PSI	GPM at 100 PSI	GPM at 110 PSI	GPM at 120 PSI
11	178*	169*	157*	138	117	97	72	48	22		
12	183*	176*	165*	149*	131	111	93	74	52	29	
13	188*	182*	173*	159*	141	124	106	89	71	53	33

9313C-M08, 9313CU-M08, 9313S-M08, 9313SU-M08

METRIC UNITS

Hyd. Flow LPM	LPM at 1.4 BAR	LPM at 2.1 BAR	LPM at 2.8 BAR	LPM at 3.4 BAR	LPM at 4.1 BAR	LPM at 4.8 BAR	LPM at 5.5 BAR	LPM at 6.2 BAR	LPM at 6.9 BAR	LPM at 7.6 BAR	LPM at 8.3 BAR
41.6	674*	640*	594*	522	443	367	273	182	83		
45.4	693*	666*	625*	564*	496	420	352	280	197	110	
49.2	712*	689*	655*	602*	534	469	401	337	269	201	125

9313C-M10, 9313CU-M10, 9313S-M10, 9313SU-M10

U.S. UNITS

Hyd. Flow GPM	GPM at 30 PSI	GPM at 40 PSI	GPM at 50 PSI	GPM at 60 PSI	GPM at 70 PSI	GPM at 80 PSI	GPM at 90 PSI	GPM at 100 PSI	GPM at 110 PSI	GPM at 120 PSI	GPM at 130 PSI
13	185*	176*	162*	143	122	99	68	24			
14	190*	183*	172*	155*	137	117	96	70	35		
15	193*	187*	179*	168*	154*	135	113	91	66	41	16
16	197*	192*	186*	178*	166*	150	132	114	96	76	55

9313C-M10, 9313CU-M10, 9313S-M10, 9313SU-M10

METRIC UNITS

Hyd. Flow LPM	LPM at 2.1 BAR	LPM at 2.8 BAR	LPM at 3.4 BAR	LPM at 4.1 BAR	LPM at 4.8 BAR	LPM at 5.5 BAR	LPM at 6.2 BAR	LPM at 6.9 BAR	LPM at 7.6 BAR	LPM at 8.3 BAR	LPM at 9.0 BAR
49.2	700*	666*	613*	541	462	375	257	91			
53.0	719*	693*	651*	587*	519	443	363	265	132		
56.8	731*	708*	678*	636*	583*	511	428	344	250	155	61
60.6	746*	727*	704*	674*	628*	568	500	432	363	288	208

9313C-M16, 9313CU-M16, 9313S-M16, 9313SU-M16

U.S. UNITS

Hyd. Flow GPM	GPM at 20 PSI	GPM at 30 PSI	GPM at 40 PSI	GPM at 50 PSI	GPM at 60 PSI	GPM at 70 PSI	GPM at 80 PSI	GPM at 90 PSI	GPM at 100 PSI
16	168*	154*	134	105	66				
18	185*	177*	165*	145*	119	85	41		
20	194*	190*	184*	175*	160*	139	115	78	20

9313C-M16, 9313CU-M16, 9313S-M16, 9313SU-M16

METRIC UNITS

Hyd. Flow LPM	LPM at 1.4 BAR	LPM at 2.1 BAR	LPM at 2.8 BAR	LPM at 3.4 BAR	LPM at 4.1 BAR	LPM at 4.8 BAR	LPM at 5.5 BAR	LPM at 6.2 BAR	LPM at 6.9 BAR
60.6	636*	583*	507*	397	250				
68.1	700*	670*	625*	549*	450	322	155		
75.7	734*	719*	697*	662*	606*	526	435	295	76

*Flow rates can only be achieved with sufficient NPSHA (Net Positive Suction Head Available), refer to OIPM for details.

HYDRAULICALLY-DRIVEN, CAST IRON & STAINLESS STEEL, SELF-PRIMING

Series 9303C-SP and 9303S-SP



UPGRADE OPTIONS:

- ◆ Increase dry-run and abrasive resistance with Life Guard Seals
 - Life Guard seals are the OEM standard
- ◆ Extend pump life with Stainless Steel
 - Fact: Chemical corrosion, pump cavitation, and abrasive wear are key factors in pump life
 - 316 Stainless Steel pumps provide superior chemical corrosion resistance, while maintaining material strength to prolong the life against abrasive wear
 - 316 Stainless Steel resists cavitation pitting of pumps, extending the wear life
 - Drop in replacements for cast iron pumps

FEATURES:

- ◆ Available in cast iron and 316 stainless steel for extended pump life
- ◆ Hydraulic motor drive (for open center, closed center and load-sensing systems)
- ◆ Port sizes: 1-1/2" NPT inlet, 1-1/4" NPT outlet
- ◆ Max. fluid temperature: 140°F/60°C
- ◆ Impeller: Cast Iron models – Nylon; (GTX available)
Stainless Steel models – Polypropylene
- ◆ Motor: internal gear gerotor
- ◆ Hydraulic ports: 1/2" NPT inlet, 3/4" NPT outlet
- ◆ Max. motor psi: 3000 (bar: 207)
- ◆ Pump seals: Cast Iron models – Viton®/ceramic standard; Life Guard silicon carbide (B) available; Stainless Steel models – Life Guard silicon carbide standard
- ◆ Life Guard seals are the industry standard on OEM equipment
- ◆ Hydraulic motor seal: double-lip Teflon®
- ◆ Weight: 38 lbs./17.3 kg

ORDER INFORMATION

Model Number	Max GPM	Max LPM	Max PSI	Max BAR	Max Hyd. GPM	Max Hyd. LPM	Hydraulic Selection System
9303C-HM1C-SP	122	462	130	9.0	13	49.2	Open/Closed
9303C-HM2C-SP	104	398	80	5.5	6	22.7	Open/Closed
9303C-HM3C-SP	120	454	95	6.5	24	90.8	Open/Closed
9303C-HM4C-SP	99	375	97	6.7	7	26.5	Open/Closed
9303C-HM5C-SP	140	530	140	9.7	16	60.5	Open/Closed
9303S-HM1C-SP	114	432	130	9.0	13	49.2	Open/Closed
9303S-HM2C-SP	97	361	95	6.5	6	22.7	Open/Closed
9303S-HM3C-SP	125	473	98	6.8	20	75.7	Open/Closed
9303S-HM4C-SP	115	435	93	6.4	7	26.5	Open/Closed
9303S-HM5C-SP	147	556	145	9.9	16	60.5	Open/Closed
3430-0589	Life Guard silicon carbide seal kit						
3430-0480SP	Self priming chamber kit						

Life Guard silicon carbide seal - Add suffix "B" (i.e.: 9303C-HM1C-SP-B)

Teflon® is a registered trademark of E.I. DuPont de Nemours and Co.
Viton® is a registered trademark of DuPont. Hypro® is a registered trademark of Pentair.

HYDRAULICALLY-DRIVEN, CAST IRON & STAINLESS STEEL, SELF-PRIMING

Series 9303C-SP and 9303S-SP

9303C-HM1C-SP, 9303S-HM1C-SP

U.S. UNITS

Hyd. Flow GPM	GPM at 10 PSI	GPM at 20 PSI	GPM at 30 PSI	GPM at 40 PSI	GPM at 50 PSI	GPM at 60 PSI	GPM at 70 PSI	GPM at 80 PSI	GPM at 90 PSI	GPM at 100 PSI	GPM at 110 PSI
11	119	111	102	89	75	58	42	25			
12	122	120	113	104	94	81	69	55	39	24	
13	122	121	119	111	102	90	78	65	52	39	26

9303C-HM1C-SP, 9303S-HM1C-SP

METRIC UNITS

Hyd. Flow LPM	LPM at 0.7 BAR	LPM at 1.4 BAR	LPM at 2.1 BAR	LPM at 2.8 BAR	LPM at 3.4 BAR	LPM at 4.1 BAR	LPM at 4.8 BAR	LPM at 5.5 BAR	LPM at 6.2 BAR	LPM at 6.9 BAR	LPM at 7.6 BAR
41.6	450	420	386	337	284	220	159	95			
45.4	462	454	428	394	356	307	261	208	148	91	
49.2	462	458	450	420	386	341	295	246	197	148	98

9303C-HM2C-SP, 9303S-HM2C-SP

U.S. UNITS

Hyd. Flow GPM	GPM at 10 PSI	GPM at 20 PSI	GPM at 30 PSI	GPM at 40 PSI	GPM at 50 PSI	GPM at 60 PSI	GPM at 70 PSI
4	57	43	26				
5	80	67	53	39	23		
6	98	88	78	67	55	42	29

9303C-HM2C-SP, 9303S-HM2C-SP

METRIC UNITS

Hyd. Flow LPM	LPM at 0.7 BAR	LPM at 1.4 BAR	LPM at 2.1 BAR	LPM at 2.8 BAR	LPM at 3.4 BAR	LPM at 4.1 BAR	LPM at 4.8 BAR
15.1	216	163	98				
18.9	303	254	201	148	87		
22.7	371	333	295	254	208	159	110

9303C-HM3C-SP, 9303S-HM3C-SP

U.S. UNITS

Hyd. Flow GPM	GPM at 10 PSI	GPM at 20 PSI	GPM at 30 PSI	GPM at 40 PSI	GPM at 50 PSI	GPM at 60 PSI	GPM at 70 PSI	GPM at 80 PSI
15	104	90	74	55	23			
18	119	113	102	87	69	46		
20	120	119	114	106	91	74	55	33

9303C-HM3C-SP, 9303S-HM3C-SP

METRIC UNITS

Hyd. Flow LPM	LPM at 0.7 BAR	LPM at 1.4 BAR	LPM at 2.1 BAR	LPM at 2.8 BAR	LPM at 3.4 BAR	LPM at 4.1 BAR	LPM at 4.8 BAR	LPM at 5.5 BAR
56.8	394	341	280	208	87			
68.1	450	428	386	329	261	174		
75.7	454	450	432	401	344	280	208	125

9303C-HM4C-SP, 9303S-HM4C-SP

U.S. UNITS

Hyd. Flow GPM	GPM at 10 PSI	GPM at 20 PSI	GPM at 30 PSI	GPM at 40 PSI	GPM at 50 PSI	GPM at 60 PSI	GPM at 70 PSI	GPM at 80 PSI
5	72	60	46	30	15			
6	87	79	66	52	38	27	13	
7	95	91	84	71	58	42	30	16

9303C-HM4C-SP, 9303S-HM4C-SP

METRIC UNITS

Hyd. Flow LPM	LPM at 0.7 BAR	LPM at 1.4 BAR	LPM at 2.1 BAR	LPM at 2.8 BAR	LPM at 3.4 BAR	LPM at 4.1 BAR	LPM at 4.8 BAR	LPM at 5.5 BAR
18.9	273	227	174	114	57			
22.7	329	299	250	197	144	102	49	
26.5	360	344	318	269	220	159	114	61

9303C-HM5C-SP, 9303S-HM5C-SP

U.S. UNITS

Hyd. Flow GPM	GPM at 10 PSI	GPM at 20 PSI	GPM at 30 PSI	GPM at 40 PSI	GPM at 50 PSI	GPM at 60 PSI	GPM at 70 PSI	GPM at 80 PSI	GPM at 90 PSI	GPM at 100 PSI	GPM at 110 PSI
41.6	450	420	386	337	284	220	159	95			
45.4	462	454	428	394	356	307	261	208	148	91	
49.2	462	458	450	420	386	341	295	246	197	148	98

9303C-HM5C-SP, 9303S-HM5C-SP

METRIC UNITS

Hyd. Flow LPM	LPM at 0.7 BAR	LPM at 1.4 BAR	LPM at 2.1 BAR	LPM at 2.8 BAR	LPM at 3.4 BAR	LPM at 4.1 BAR	LPM at 4.8 BAR	LPM at 5.5 BAR	LPM at 6.2 BAR	LPM at 6.9 BAR	LPM at 7.6 BAR
49.2	432	420	386	337	284	220	159	95			
53.0	447	443	428	394	356	307	261	208	148	91	
56.8	462	458	450	420	386	341	295	246	197	148	98

HYDRAULICALLY-DRIVEN, POLYPROPYLENE

Series 9303P



UPGRADE OPTIONS:

- ◆ Increase abrasive resistance with Life Guard Seals
 - Life Guard seals are the OEM standard

FEATURES:

- ◆ Hydraulic motor drive (for open center, closed center and load-sensing systems)
- ◆ Port sizes: 1-1/2" NPT inlet, 1-1/4" NPT outlet
- ◆ Max. fluid temperature: 140°F/60°C
- ◆ Housing: Polypropylene
- ◆ Impeller: Polypropylene
- ◆ Motor: internal gear gerotor
- ◆ Hydraulic ports: 1/2" NPT inlet, 3/4" NPT outlet
- ◆ Pump seals: Viton®/ceramic standard; Life Guard silicon carbide (B) available
- ◆ Life Guard seals are the industry standard on OEM equipment
- ◆ Hydraulic motor seal: double-lip Teflon®
- ◆ Max. motor psi: 3000 (bar: 207)
- ◆ Weight: 21 lbs./9.5 kg

ORDER INFORMATION

Model Number	Max GPM	Max LPM	Max PSI	Max BAR	Max Hyd. GPM	Max Hyd. LPM	Hydraulic Selection System
9303P-HM1C	110	416	130	9.0	13	49.2	Open/Closed
9303P-HM2C	82	310	95	6.5	6	22.7	Open/Closed
9303P-HM3C	110	416	93	6.4	24	90.8	Open/Closed
9303P-HM4C	82	310	84	5.3	7	26.5	Open/Closed
9303P-HM5C	113	427	120	8.3	16	60.5	Open/Closed
3430-0445							Seal and o-ring repair kit
3430-0593							Life Guard silicon carbide seal kit

Life Guard silicon carbide seal - Add suffix "B" (i.e.: 9303P-HM1C-B)

9303P-HM1C

U.S. UNITS

Hyd. Flow GPM	GPM at 10 PSI	GPM at 20 PSI	GPM at 30 PSI	GPM at 40 PSI	GPM at 50 PSI	GPM at 60 PSI	GPM at 70 PSI	GPM at 80 PSI	GPM at 90 PSI	GPM at 100 PSI	GPM at 110 PSI	GPM at 120 PSI
11	93	90	86	80	74	67	59	49	36	18		
12	102	99	95	91	87	81	74	66	55	39	19	
13	109	106	103	99	94	88	82	74	65	54	42	28

9303P-HM1C

METRIC UNITS

Hyd. Flow LPM	LPM at 0.7 BAR	LPM at 1.4 BAR	LPM at 2.1 BAR	LPM at 2.8 BAR	LPM at 3.4 BAR	LPM at 4.1 BAR	LPM at 4.8 BAR	LPM at 5.5 BAR	LPM at 6.2 BAR	LPM at 6.9 BAR	LPM at 7.6 BAR	LPM at 8.3 BAR
41.6	352	341	326	303	280	254	223	185	136	68		
45.4	386	375	360	344	329	307	280	250	208	148	72	
49.2	413	401	390	375	356	333	310	280	246	204	159	106

9303P-HM2C

U.S. UNITS

Hyd. Flow GPM	GPM at 10 PSI	GPM at 20 PSI	GPM at 30 PSI	GPM at 40 PSI	GPM at 50 PSI	GPM at 60 PSI	GPM at 70 PSI	GPM at 80 PSI	GPM at 90 PSI
5	65	56	46	38	20				
6	74	72	64	56	48	38	21		
7	80	75	70	62	57	48	40	28	9

9303P-HM2C

METRIC UNITS

Hyd. Flow LPM	LPM at 0.7 BAR	LPM at 1.4 BAR	LPM at 2.1 BAR	LPM at 2.8 BAR	LPM at 3.4 BAR	LPM at 4.1 BAR	LPM at 4.8 BAR	LPM at 5.5 BAR	LPM at 6.2 BAR
18.9	246	212	174	144	76				
22.7	280	273	242	212	182	144	79		
26.5	303	284	265	235	216	182	151	106	34

9303P-HM3C

U.S. UNITS

Hyd. Flow GPM	GPM at 10 PSI	GPM at 20 PSI	GPM at 30 PSI	GPM at 40 PSI	GPM at 50 PSI	GPM at 60 PSI	GPM at 70 PSI	GPM at 80 PSI	GPM at 90 PSI
15	85	80	70	60	44				
18	100	97	92	84	76	63	48		
20	109	108	104	99	90	82	71	60	39

9303P-HM3C

METRIC UNITS

Hyd. Flow LPM	LPM at 0.7 BAR	LPM at 1.4 BAR	LPM at 2.1 BAR	LPM at 2.8 BAR	LPM at 3.4 BAR	LPM at 4.1 BAR	LPM at 4.8 BAR	LPM at 5.5 BAR	LPM at 6.2 BAR
56.8	322	303	265	227	167				
68.1	379	367	348	318	288	238	182		
75.7	413	409	394	375	341	310	269	227	148

9303P-HM4C

U.S. UNITS

Hyd. Flow GPM	GPM at 10 PSI	GPM at 20 PSI	GPM at 30 PSI	GPM at 40 PSI	GPM at 50 PSI	GPM at 60 PSI	GPM at 70 PSI	GPM at 80 PSI
5	60	52	41	26				
6	70	66	58	48	37	21		
7	80	76	70	63	55	45	32	15

9303P-HM4C

METRIC UNITS

Hyd. Flow LPM	LPM at 0.7 BAR	LPM at 1.4 BAR	LPM at 2.1 BAR	LPM at 2.8 BAR	LPM at 3.4 BAR	LPM at 4.1 BAR	LPM at 4.8 BAR	LPM at 5.5 BAR
18.9	227	197	155	98				
22.7	265	250	220	182	140	79		
26.5	303	288	265	238	208	170	121	57

9303P-HM5C

U.S. UNITS

Hyd. Flow GPM	GPM at 10 PSI	GPM at 20 PSI	GPM at 30 PSI	GPM at 40 PSI	GPM at 50 PSI	GPM at 60 PSI	GPM at 70 PSI	GPM at 80 PSI	GPM at 90 PSI	GPM at 100 PSI	GPM at 110 PSI
12	94	92	86	78	68	58	44	15			
13	100	98	94	88	79	70	60	48	25		
14	108	107	104	100	94	86	77	68	57	42	
15	113	112	110	106	100	93	86	78	68	56	40

9303P-HM5C

METRIC UNITS

Hyd. Flow LPM	LPM at 0.7 BAR	LPM at 1.4 BAR	LPM at 2.1 BAR	LPM at 2.8 BAR	LPM at 3.4 BAR	LPM at 4.1 BAR	LPM at 4.8 BAR	LPM at 5.5 BAR	LPM at 6.2 BAR	LPM at 6.9 BAR	LPM at 7.6 BAR
45.4	356	348	326	295	257	220	167	57			
49.2	379	371	356	333	299	265	227	182	95		
53.0	409	405	394	379	356	326	291	257	216	159	
56.8	428	424	416	401	379	352	326	295	257	212	151

HYDRAULICALLY-DRIVEN, CAST IRON

Series 9305C



UPGRADE OPTIONS:

- ◆ Increase dry-run and abrasive resistance with Life Guard Seals
 - Life Guard seals are the OEM standard

FEATURES:

- ◆ Available in cast iron
- ◆ Hydraulic motor drive (for open center, closed center and load-sensing systems)
- ◆ Port sizes: 2" NPT inlet, 1-1/2" NPT outlet
- ◆ Max. fluid temperature: 140°F/60°C
- ◆ Impeller: Nylon
- ◆ Motor: internal gear gerotor
- ◆ Hydraulic ports: 1/2" NPT inlet, 3/4" NPT outlet
- ◆ Max. motor psi: 3000 (bar: 207)
- ◆ Pump seals: Viton®/ceramic standard; Life Guard silicon carbide (B) available
- ◆ Life Guard seals are the industry standard on OEM equipment
- ◆ Hydraulic motor seal: double-lip Teflon®
- ◆ Weight: 48 lbs./21.8 kg

ORDER INFORMATION

Model Number	Max GPM	Max LPM	Max PSI	Max BAR	Max Hyd. GPM	Max Hyd. LPM	Hydraulic Selection System
9305C-HM3C	182	689	156	10.8	19	72	Open/Closed
3430-0500	Seal and o-ring repair kit						
3430-0601	Life Guard silicon carbide seal kit						

Life Guard silicon carbide seal - Add suffix "B" (i.e.: 9305C-HM3C-B)

9305C-HM3C

U.S. UNITS

Hyd. Flow GPM	GPM at 50 PSI	GPM at 60 PSI	GPM at 70 PSI	GPM at 80 PSI	GPM at 90 PSI	GPM at 100 PSI	GPM at 110 PSI	GPM at 120 PSI	GPM at 130 PSI	GPM at 140 PSI
17	173	164	148	127	97	70	44	14		
18	177	175	168	154	135	109	87	62	34	
19	180	179	177	167	151	134	115	95	72	44

9305C-HM3C

METRIC UNITS

Hyd. Flow LPM	LPM at 3.4 BAR	LPM at 4.1 BAR	LPM at 4.8 BAR	LPM at 5.5 BAR	LPM at 6.2 BAR	LPM at 6.9 BAR	LPM at 7.6 BAR	LPM at 8.3 BAR	LPM at 9.0 BAR	LPM at 9.7 BAR
64.4	655	621	560	481	367	265	167	53		
68.1	670	662	636	583	511	413	329	235	129	
71.9	685	678	670	632	572	507	435	360	273	167

Teflon® is a registered trademark of E.I. DuPont de Nemours and Co.

Viton® is a registered trademark of DuPont. Hypro® is a registered trademark of Pentair.

HYDRAULICALLY-DRIVEN, CAST IRON, SELF-PRIMING

Series 9305C-SP and 9305C-BSP



UPGRADE OPTIONS:

- ◆ Increase dry-run and abrasive resistance with Life Guard Seals
 - Life Guard seals are the OEM standard

FEATURES:

- ◆ Available in cast iron
- ◆ Hydraulic motor drive (for open center, closed center and load-sensing systems)
- ◆ Port sizes: 2" NPT inlet, 2" NPT outlet (Model 9305C-HM3C-SP), 2" BSP inlet, 2" BSP outlet (Model 9305C-HM3C-BSP)
- ◆ Max. fluid temperature: 140°F/60°C
- ◆ Impeller: Nylon
- ◆ Motor: internal gear gerotor
- ◆ Hydraulic ports: 1/2" NPT inlet, 3/4" NPT outlet
- ◆ Max. motor psi: 3000 (bar: 207)
- ◆ Pump seals: Viton®/ceramic standard; Life Guard silicon carbide (B) available
- ◆ Life Guard seals are the industry standard on OEM equipment
- ◆ Hydraulic motor seal: double-lip Teflon®
- ◆ Weight: 59 lbs./26.8 kg

ORDER INFORMATION

Model Number	Max GPM	Max LPM	Max PSI	Max BAR	Max Hyd. GPM	Max Hyd LPM	Hydraulic Selection System
9305C-HM3C-SP	155	587	143	9.9	19	72	Open/Closed
9305C-HM3C-BSP	155	587	143	9.9	19	72	Open/Closed
3430-0601	Life Guard silicon carbide seal kit						
3430-0481SP	Self priming chamber kit						
3430-0481BSP	Self priming chamber kit (BSP)						

Life Guard silicon carbide seal - Add suffix "B" (i.e.: 9305C-HM3C-B-SP)

9305C-HM3C-SP, 9305C-HM3C-BSP

U.S. UNITS

Hyd. Flow GPM	GPM at 30 PSI	GPM at 40 PSI	GPM at 50 PSI	GPM at 60 PSI	GPM at 70 PSI	GPM at 80 PSI	GPM at 90 PSI	GPM at 100 PSI	GPM at 110 PSI	GPM at 120 PSI	GPM at 130 PSI
17	148	145	135	118	100	81	60	37	17		
18	150	149	147	138	120	102	81	60	38	14	
19	153	152	150	147	140	120	104	85	66	45	28

9305C-HM3C-SP, 9305C-HM3C-BSP

METRIC UNITS

Hyd. Flow LPM	LPM at 2.1 BAR	LPM at 2.8 BAR	LPM at 3.4 BAR	LPM at 4.1 BAR	LPM at 4.8 BAR	LPM at 5.5 BAR	LPM at 6.2 BAR	LPM at 6.9 BAR	LPM at 7.6 BAR	LPM at 8.3 BAR	LPM at 9.0 BAR
64.4	560	549	511	447	379	307	227	140	64		
68.1	568	564	556	522	454	386	307	227	144	53	
71.9	579	575	568	556	553	454	394	322	250	170	106

Teflon® is a registered trademark of E.I. DuPont de Nemours and Co.

Viton® is a registered trademark of DuPont. Hypro® is a registered trademark of Pentair.

HYDRAULICALLY-DRIVEN, CAST IRON & STAINLESS STEEL

Series 9306C and 9306S



UPGRADE OPTIONS:

- ◆ Increase dry-run and abrasive resistance with Life Guard Seals
 - Life Guard seals are the OEM standard
- ◆ Extend pump life with Stainless Steel
 - Fact: Chemical corrosion, pump cavitation, and abrasive wear are key factors in pump life
 - 316 Stainless Steel pumps provide superior chemical corrosion resistance, while maintaining material strength to prolong the life against abrasive wear
 - 316 Stainless Steel resists cavitation pitting of pumps, extending the wear life
 - Drop in replacements for cast iron pumps

FEATURES:

- ◆ Hydraulic motor drive (for open center, closed center and load-sensing systems)
- ◆ Port sizes: 2" NPT inlet, 1-1/2" NPT outlet; 220 x 220 (U) Universal flange available
- ◆ Max. fluid temperature: 140°F/60°C
- ◆ Available in cast iron and 316 stainless steel for extended pump life
- ◆ Impeller: Nylon (cast iron models); polypropylene (stainless steel models); (GTX available)
- ◆ Motor: internal gear gerotor
- ◆ Hydraulic ports: 1/2" NPT inlet, 3/4" NPT outlet
- ◆ Max. motor psi: 3000 (bar: 207)
- ◆ Pump seals: Cast Iron models – Viton®/ceramic standard; Life Guard silicon carbide (B) available; Stainless Steel models – Life Guard silicon carbide standard
- ◆ Life Guard seals are the industry standard on OEM equipment
- ◆ Hydraulic motor seal: double-lip Teflon®
- ◆ Weight: 33 lbs./15 kg

FOR FLANGED CONNECTIONS YOU WILL ALSO NEED:

- Universal Flange Gasket
- Universal Flange Clamp

See 251 for details

ORDER INFORMATION

Model Number	Max GPM	Max LPM	Max PSI	Max BAR	Max Hyd. GPM	Max Hyd. LPM	Hydraulic Selection System
9306C-HM1C*	207	784	127	8.8	13	49.2	Open/Closed
9306C-HM3C*	214	810	128	8.8	24	90.8	Open/Closed
9306C-HM5C*	212	803	140	9.6	17	64.4	Open/Closed
9306S-HM1C	207	784	127	8.8	13	49.2	Open/Closed
9306S-HM3C	214	810	128	8.8	24	90.8	Open/Closed
9306S-HM5C	212	803	140	9.6	17	64.4	Open/Closed
3430-0332	Seal and o-ring repair kit						
3430-0589	Life Guard silicon carbide seal kit						

*Universal Flange (220 x 220) - Add Suffix "U" (i.e.: 9306C-HM3C-U) - Life Guard silicon carbide seal - Add suffix "B" (i.e.: 9306C-HM3C-B)

9306C-HM1C, 9306S-HM1C, 9306C-HM1C-U, 9306S-HM1C-U

U.S. UNITS

Hyd. Flow GPM	GPM at 30 PSI	GPM at 40 PSI	GPM at 50 PSI	GPM at 60 PSI	GPM at 70 PSI	GPM at 80 PSI	GPM at 90 PSI	GPM at 100 PSI	GPM at 110 PSI	GPM at 120 PSI
11	207	200	186	155	122	88	44			
12	207	207	196	179	149	119	88	53		
13	207	207	207	195	171	144	115	85	53	20

9306C-HM1C, 9306S-HM1C, 9306C-HM1C-U, 9306S-HM1C-U

METRIC UNITS

Hyd. Flow LPM	LPM at 2.1 BAR	LPM at 2.8 BAR	LPM at 3.4 BAR	LPM at 4.1 BAR	LPM at 4.8 BAR	LPM at 5.5 BAR	LPM at 6.2 BAR	LPM at 6.9 BAR	LPM at 7.6 BAR	LPM at 8.3 BAR
41.6	784	757	704	587	462	333	167			
45.4	784	784	742	678	564	450	333	201		
49.2	784	784	784	738	647	545	435	322	201	76

9306C-HM3C, 9306S-HM3C, 9306C-HM3C-U, 9306S-HM3C-U

U.S. UNITS

Hyd. Flow GPM	GPM at 40 PSI	GPM at 50 PSI	GPM at 60 PSI	GPM at 70 PSI	GPM at 80 PSI	GPM at 90 PSI	GPM at 100 PSI	GPM at 110 PSI	GPM at 120 PSI
18	190	179	159	90					
20	214	203	199	181	139	49			
22	214	214	214	210	198	176	127	16	
24	214	214	214	214	214	210	190	154	101

9306C-HM3C, 9306S-HM3C, 9306C-HM3C-U, 9306S-HM3C-U

METRIC UNITS

Hyd. Flow LPM	LPM at 2.8 BAR	LPM at 3.4 BAR	LPM at 4.1 BAR	LPM at 4.8 BAR	LPM at 5.5 BAR	LPM at 6.2 BAR	LPM at 6.9 BAR	LPM at 7.6 BAR	LPM at 8.3 BAR
68.1	719	678	602	341					
75.7	810	768	753	685	526	185			
83.3	810	810	810	795	750	666	481	61	
90.8	810	810	810	810	810	795	719	583	382

9306C-HM5C, 9306S-HM5C, 9306C-HM5C-U, 9306S-HM5C-U

U.S. UNITS

Hyd. Flow GPM	GPM at 40 PSI	GPM at 50 PSI	GPM at 60 PSI	GPM at 70 PSI	GPM at 80 PSI	GPM at 90 PSI	GPM at 100 PSI	GPM at 110 PSI	GPM at 120 PSI	GPM at 130 PSI
15	212	212	212	187	150	114	65	19		
16	212	212	212	212	189	158	125	87	42	
17	212	212	212	212	212	189	162	133	102	58

9306C-HM5C, 9306S-HM5C, 9306C-HM5C-U, 9306S-HM5C-U

METRIC UNITS

Hyd. Flow LPM	LPM at 2.8 BAR	LPM at 3.4 BAR	LPM at 4.1 BAR	LPM at 4.8 BAR	LPM at 5.5 BAR	LPM at 6.2 BAR	LPM at 6.9 BAR	LPM at 7.6 BAR	LPM at 8.3 BAR	LPM at 9.0 BAR
56.8	803	803	803	708	568	432	246	72		
60.6	803	803	803	803	715	598	473	329	159	
64.4	803	803	803	803	803	715	613	503	386	220

Teflon® is a registered trademark of E.I. DuPont de Nemours and Co.
Viton® is a registered trademark of DuPont. Hypro® is a registered trademark of Pentair.

HYDRAULICALLY-DRIVEN, CAST IRON & STAINLESS STEEL-3U FLANGED

Series 9306C-3U and 9306S-3U



UPGRADE OPTIONS:

- ◆ Increase dry-run and abrasive resistance with Life Guard Seals
 - Life Guard seals are the OEM standard
- ◆ Extend pump life with Stainless Steel
 - Fact: Chemical corrosion, pump cavitation, and abrasive wear are key factors in pump life
 - 316 Stainless Steel pumps provide superior chemical corrosion resistance, while maintaining material strength to prolong the life against abrasive wear
 - 316 Stainless Steel resists cavitation pitting of pumps, extending the wear life
 - Drop in replacements for cast iron pumps

FEATURES:

- ◆ Hydraulic motor drive (for open center, closed center and load-sensing systems)
- ◆ Port Sizes: 300 x 220 (3U) Universal flange
- ◆ Max. fluid temperature: 140°F/60°C
- ◆ Available in cast iron and 316 stainless steel for extended pump life
- ◆ Impeller: Nylon (cast iron models); polypropylene (stainless steel models); (GTX available)
- ◆ Motor: internal gear gerotor
- ◆ Hydraulic ports: 1/2" NPT inlet, 3/4" NPT outlet
- ◆ Max. motor psi: 3000 (bar: 207)
- ◆ Pump seals: Cast Iron models - Viton®/ceramic standard; Life Guard silicon carbide (B) available; Stainless Steel models - Life Guard silicon carbide
- ◆ Life Guard seals are the industry standard on OEM equipment
- ◆ Hydraulic motor seal: double-lip Teflon®
- ◆ Weight: 33 lbs./15 kg

FOR FLANGED CONNECTIONS YOU WILL ALSO NEED:

- Universal Flange Gasket Universal Flange Clamp

See 251 for details

ORDER INFORMATION

Model Number	Max GPM	MaxLPM	MaxPSI	MaxBAR	Max Hyd.GPM	Max Hyd. LPM	Hydraulic Selection System
9306C-HM1C-3U	283	1071	127	8.8	13	49.2	Open/Closed
9306C-HM3C-3U	322	1219	128	8.8	24	90.3	Open/Closed
9306C-HM5C-3U	312	1181	140	9.6	17	64.4	Open/Closed
9306S-HM1C-3U	283	1071	127	8.8	13	49.2	Open/Closed
9306S-HM3C-3U	322	1219	128	8.8	24	90.3	Open/Closed
9306S-HM5C-3U	312	1181	140	9.6	17	64.4	Open/Closed
3430-0332	Seal and o-ring repair kit						
3430-0589	Life Guard silicon carbide seal kit						

Life Guard silicon carbide seal - Add suffix "B" (i.e.: 9306C-HM1C-B3U)

9306C-HM1C-3U, 9306S-HM1C-3U

U.S. UNITS

Hyd. Flow GPM	GPM at 30 PSI	GPM at 40 PSI	GPM at 50 PSI	GPM at 60 PSI	GPM at 70 PSI	GPM at 80 PSI	GPM at 90 PSI	GPM at 100 PSI	GPM at 110 PSI	GPM at 120 PSI
11	255	225	190	155	122	88	44	5		
12	271	242	211	179	149	119	88	53	19	
13	283	258	226	199	171	144	115	85	53	24

9306C-HM1C-3U, 9306S-HM1C-3U

METRIC UNITS

Hyd. Flow LPM	LPM at 2.1 BAR	LPM at 2.8 BAR	LPM at 3.4 BAR	LPM at 4.1 BAR	LPM at 4.8 BAR	LPM at 5.5 BAR	LPM at 6.2 BAR	LPM at 6.9 BAR	LPM at 7.6 BAR	LPM at 8.3 BAR
41.6	965	852	719	587	462	333	167	19		
45.4	1026	916	799	678	564	450	333	201	72	
49.2	1071	977	856	753	647	545	435	322	201	91

9306C-HM3C-3U, 9306S-HM3C-3U

U.S. UNITS

Hyd. Flow GPM	GPM at 30 PSI	GPM at 40 PSI	GPM at 50 PSI	GPM at 60 PSI	GPM at 70 PSI	GPM at 80 PSI	GPM at 90 PSI	GPM at 100 PSI	GPM at 110 PSI	GPM at 120 PSI
18	285	256	213	165	90					
20	308	297	268	233	192	139	49			
22	312	312	308	288	255	219	176	127	16	
24	322	322	320	316	298	265	231	196	154	101

9306C-HM3C-3U, 9306S-HM3C-3U

METRIC UNITS

Hyd. Flow LPM	LPM at 2.1 BAR	LPM at 2.8 BAR	LPM at 3.4 BAR	LPM at 4.1 BAR	LPM at 4.8 BAR	LPM at 5.5 BAR	LPM at 6.2 BAR	LPM at 6.9 BAR	LPM at 7.6 BAR	LPM at 8.3 BAR
68.1	1079	969	806	624	341					
75.7	1166	1124	1014	882	727	526	185			
83.3	1181	1181	1166	1090	965	829	666	481	61	
90.8	1219	1219	1211	1196	1128	1003	874	742	583	382

9306C-HM5C-3U, 9306S-HM5C-3U

U.S. UNITS

Hyd. Flow GPM	GPM at 30 PSI	GPM at 40 PSI	GPM at 50 PSI	GPM at 60 PSI	GPM at 70 PSI	GPM at 80 PSI	GPM at 90 PSI	GPM at 100 PSI	GPM at 110 PSI	GPM at 120 PSI	GPM at 130 PSI
15	285	269	242	212	182	149	112	68	19		
16	308	291	269	242	212	179	149	115	78	37	
17	312	312	297	270	242	214	187	154	122	82	44

9306C-HM5C-3U, 9306S-HM5C-3U

METRIC UNITS

Hyd. Flow LPM	LPM at 2.1 BAR	LPM at 2.8 BAR	LPM at 3.4 BAR	LPM at 4.1 BAR	LPM at 4.8 BAR	LPM at 5.5 BAR	LPM at 6.2 BAR	LPM at 6.9 BAR	LPM at 7.6 BAR	LPM at 8.3 BAR	LPM at 8.9 BAR
56.8	1079	1018	916	802	689	564	424	257	72		
60.6	1166	1101	1018	916	802	677	564	435	307	159	
64.4	1181	1181	1124	1022	916	810	708	583	462	310	167

Teflon® is a registered trademark of E.I. DuPont de Nemours and Co.
 Viton® is a registered trademark of DuPont. Hypro® is a registered trademark of Pentair.

FORCEFIELD, CAST IRON & STAINLESS STEEL

Series 9314



UPGRADE OPTIONS:

- ◆ Extend pump life with Stainless Steel
 - Fact: Chemical corrosion, pump cavitation, and abrasive wear are key factors in pump life
 - 316 Stainless Steel pumps provide superior chemical corrosion resistance, while maintaining material strength to prolong life against abrasive wear
 - 316 Stainless Steel resists cavitation pitting of pumps, extending wear life
- ◆ Hydraulic motor with case drain for maximum motor life

FEATURES:

- ◆ ForceField Technology is a superior wet seal technology that provides the ultimate protection for the mechanical seal and avoids costly downtime
- ◆ Protects the mechanical seal against common failures related to dry run and chemical bonding by using a barrier fluid to keep it cool and lubricated
- ◆ Actively maintains a pressure differential between the barrier fluid and the pumping solution, which results in longer life and worry free operation.
- ◆ Capable of flows up to 233 GPM (882 LPM) and can produce up to 150 PSI (10.3 bar)
- ◆ Designed to be a drop-in replacement for standard Hydro hydraulically driven centrifugal pumps
- ◆ One year warranty covering pump, motor and seals

FOR FLANGED CONNECTIONS YOU WILL ALSO NEED:

- Universal Flange Gasket
- Universal Flange Clamp

See 251 for details

ORDER INFORMATION

Part Number	Current Product Equivalent	Inlet/Outlet	Max GPM	Max LPM	Max PSI	Max Bar	Max Hyd. GPM	Max Hyd. LPM
9314C-M08	9306C-HMIC	2" NPT x 1-1/2" NPT	227	859	132	9.1	14	53
9314CU-M08	9306C-HMIC-U	220 x 220 Universal Flange	227	859	132	9.1	14	53
9314C-M10	9306C-HM5C	2" NPT x 1-1/2" NPT	233	882	150	10.3	17	64.4
9314CU-M10	9306C-HM5C-U	220 x 220 Universal Flange	233	882	150	10.3	17	64.4
9314C-M16	9306C-HM3C	2" NPT x 1-1/2" NPT	232	878	138	9.5	24	90.8
9314CU-M16	9306C-HM3C-U	220 x 220 Universal Flange	232	878	138	9.5	24	90.8
9314S-M08	9306S-HMIC	2" NPT x 1-1/2" NPT	227	859	132	9.1	14	53
9314SU-M08	9306S-HMIC-U	220 x 220 Universal Flange	227	859	132	9.1	14	53
9314S-M10	9306S-HM5C	2" NPT x 1-1/2" NPT	233	882	150	10.3	17	64.4
9314SU-M10	9306S-HM5C-U	220 x 220 Universal Flange	233	882	150	10.3	17	64.4
9314S-M16	9306S-HM3C	2" NPT x 1-1/2" NPT	232	878	138	9.5	24	90.8
9314SU-M16	9306S-HM3C-U	220 x 220 Universal Flange	232	878	138	9.5	24	90.8

Case Drain motor available - Add suffix "Y" (i.e. 9314CU-M08Y)

FORCEFIELD, CAST IRON & STAINLESS STEEL

Series 9314

9314C-M08, 9314CU-M08, 9314S-M08, 9314SU-M08

U.S. UNITS

Hyd. Flow GPM	GPM at 30 PSI	GPM at 40 PSI	GPM at 50 PSI	GPM at 60 PSI	GPM at 70 PSI	GPM at 80 PSI	GPM at 90 PSI	GPM at 100 PSI	GPM at 110 PSI	GPM at 120 PSI
11	217	190	152	111	73	43	12			
12	224*	203	175	146	115	80	49	24		
13	226*	211*	186	160	131	106	81	56	29	
14	227*	216*	196	171	146	120	95	71	50	27

9314C-M08, 9314CU-M08, 9314S-M08, 9314SU-M08

METRIC UNITS

Hyd. Flow LPM	LPM at 2.1 BAR	LPM at 2.8 BAR	LPM at 3.4 BAR	LPM at 4.1 BAR	LPM at 4.8 BAR	LPM at 5.5 BAR	LPM at 6.2 BAR	LPM at 6.9 BAR	LPM at 7.6 BAR	LPM at 8.3 BAR
41.6	821	719	575	420	276	163	45			
45.4	848*	768	662	553	435	303	185	91		
49.2	856*	799*	704	606	496	401	307	212		
53.0	859*	818*	742	647	553	454	360	269	189	102

9314C-M10, 9314CU-M10, 9314S-M10, 9314SU-M10

U.S. UNITS

Hyd. Flow GPM	GPM at 40 PSI	GPM at 50 PSI	GPM at 60 PSI	GPM at 70 PSI	GPM at 80 PSI	GPM at 90 PSI	GPM at 100 PSI	GPM at 110 PSI	GPM at 120 PSI	GPM at 130 PSI
15	227*	217*	200	175	147	120	87	57	22	
16	231*	224*	212	190	163	136	111	83	53	17
17	233*	228*	220*	205	179	151	125	100	74	49

9314C-M10, 9314CU-M10, 9314S-M10, 9314SU-M10

METRIC UNITS

Hyd. Flow LPM	LPM at 2.8 BAR	LPM at 3.4 BAR	LPM at 4.1 BAR	LPM at 4.8 BAR	LPM at 5.5 BAR	LPM at 6.2 BAR	LPM at 6.9 BAR	LPM at 7.6 BAR	LPM at 8.3 BAR	LPM at 9.0 BAR
56.8	859*	821*	757	662	556	454	329			
60.6	874*	848*	803	719	617	515	420	314		
64.4	882*	863*	833*	776	678	572	473	379	280	185

9314C-M16, 9314CU-M16, 9314S-M16, 9314SU-M16

U.S. UNITS

Hyd. Flow GPM	GPM at 40 PSI	GPM at 50 PSI	GPM at 60 PSI	GPM at 70 PSI	GPM at 80 PSI	GPM at 90 PSI	GPM at 100 PSI	GPM at 110 PSI	GPM at 120 PSI	GPM at 130 PSI
18	216	191	155	100	30					
20	232*	224*	203	175	135	78				
22	232*	230*	224*	211	187	153	107	51		
24	232*	230*	226*	222*	212	190	162	126	85	34

9314C-M16, 9314CU-M16, 9314S-M16, 9314SU-M16

METRIC UNITS

Hyd. Flow LPM	LPM at 2.8 BAR	LPM at 3.4 BAR	LPM at 4.1 BAR	LPM at 4.8 BAR	LPM at 5.5 BAR	LPM at 6.2 BAR	LPM at 6.9 BAR	LPM at 7.6 BAR	LPM at 8.3 BAR	LPM at 9.0 BAR
68.1	818	723	587	379	114					
75.7	878*	848*	768	662	511	295				
83.3	878*	871*	848*	799	708	579	405	193		
90.8	878*	871*	856*	840*	803	719	613	477	322	129

*Flow rates can only be achieved with sufficient NPSHA (Net Positive Suction Head Available), refer to OIPM for details.

FORCEFIELD, CAST IRON & STAINLESS STEEL

Series 9316



UPGRADE OPTIONS:

- ◆ Hydraulic motor includes a case drain for maximum motor life
 - Life Guard seals are the OEM standard
 - Fact: Chemical corrosion, pump cavitation, and abrasive wear are key factors in pump life
 - 316 Stainless Steel pumps provide superior chemical corrosion resistance, while maintaining material strength to prolong the life against abrasive wear
 - 316 Stainless Steel resists cavitation pitting of pumps, extending the wear life
 - Drop in replacements for cast iron pumps

FEATURES:

- ◆ ForceField Technology is a superior wet seal technology that provides the ultimate protection for the mechanical seal and avoids costly downtime
- ◆ Protects the mechanical seal against common failures related to dry run and chemical bonding by using a barrier fluid to keep it cool and lubricated
- ◆ Actively maintains a pressure differential between the barrier fluid and the pumping solution, which results in longer life and worry free operation.
- ◆ Capable of flows up to 311 GPM (1177 LPM) and can produce up to 150 PSI (10.3 bar)
- ◆ Designed to be a drop-in replacement for standard Hypro hydraulically driven centrifugal pumps
- ◆ One year warranty covering pump, motor and seals

FOR FLANGED CONNECTIONS YOU WILL ALSO NEED:

- Universal Flange Gasket
- Universal Flange Clamp

See 251 for details

ORDER INFORMATION

Part Number	Current Product Equivalent	Inlet/Outlet	Max GPM	Max LPM	Max PSI	Max Bar	Max Hyd. GPM	Max Hyd. LPM
9316C3U-M08	9306C-HM1C-3U	300 x 220 Universal Flange	286	1083	127	8.8	14	53
9316C3U-M10	9306C-HM5C-3U	300 x 220 Universal Flange	311	1177	150	10.3	18	68.1
9316C3U-M16	9306C-HM3C-3U	300 x 220 Universal Flange	307	1162	128	8.8	24	90.8
9316S3U-M08	9306S-HM1C-3U	300 x 220 Universal Flange	286	1083	127	8.8	14	53
9316S3U-M10	9306S-HM5C-3U	300 x 220 Universal Flange	311	1177	150	10.3	18	68.1
9316S3U-M16	9306S-HM3C-3U	300 x 220 Universal Flange	307	1162	128	8.8	24	90.8

Case Drain motor available - Add suffix "Y" (i.e. 9313CU-M08Y)

FORCEFIELD, CAST IRON & STAINLESS STEEL

Series 9316

9316C3U-M08, 9316S3U-M08

U.S. UNITS

Hyd. Flow GPM	GPM at 30 PSI	GPM at 40 PSI	GPM at 50 PSI	GPM at 60 PSI	GPM at 70 PSI	GPM at 80 PSI	GPM at 90 PSI	GPM at 100 PSI	GPM at 110 PSI	GPM at 120 PSI
11	250	213	175	131	86	40				
12	266*	232	194	154	116	82	48			
13	274*	243	207	174	140	109	78	48		
14	286*	262*	230	196	166	134	104	76	49	20

9316C3U-M08, 9316S3U-M08

METRIC UNITS

Hyd. Flow LPM	LPM at 2.1 BAR	LPM at 2.8 BAR	LPM at 3.4 BAR	LPM at 4.1 BAR	LPM at 4.8 BAR	LPM at 5.5 BAR	LPM at 6.2 BAR	LPM at 6.9 BAR	LPM at 7.6 BAR	LPM at 8.3 BAR
41.6	946	806	662	496	326	151				
45.4	1007*	878	734	583	439	310	182			
49.2	1037*	920	784	659	530	413	295	182		
53.0	1083*	992*	871	742	628	507	394	288	185	76

9316C3U-M10, 9316S3U-M10

U.S. UNITS

Hyd. Flow GPM	GPM at 30 PSI	GPM at 40 PSI	GPM at 50 PSI	GPM at 60 PSI	GPM at 70 PSI	GPM at 80 PSI	GPM at 90 PSI	GPM at 100 PSI	GPM at 110 PSI	GPM at 120 PSI	GPM at 130 PSI
15	298*	283*	255	223	189	151	108	65			
16	304*	295*	276*	247	212	175	139	104	65	29	
17	307*	299*	284*	261*	229	197	162	130	98	67	35
18	311*	303*	291*	271*	242	210	178	150	121	93	62

9316C3U-M10, 9316S3U-M10

METRIC UNITS

Hyd. Flow LPM	LPM at 2.1 BAR	LPM at 2.8 BAR	LPM at 3.4 BAR	LPM at 4.1 BAR	LPM at 4.8 BAR	LPM at 5.5 BAR	LPM at 6.2 BAR	LPM at 6.9 BAR	LPM at 7.6 BAR	LPM at 8.3 BAR	LPM at 9.0 BAR
56.8	1128*	1071*	965	844	715	572	409	246			
60.6	1151*	1117*	1045*	935	803	662	526	394	246	110	
64.4	1162*	1132*	1075*	988*	867	746	613	492	371	254	132
68.1	1177*	1147*	1102*	1026*	916	795	674	568	458	352	235

9316C3U-M16, 9316S3U-M16

U.S. UNITS

Hyd. Flow GPM	GPM at 30 PSI	GPM at 40 PSI	GPM at 50 PSI	GPM at 60 PSI	GPM at 70 PSI	GPM at 80 PSI	GPM at 90 PSI	GPM at 100 PSI	GPM at 110 PSI	GPM at 120 PSI
18	279*	249	210	164	94					
20	302*	290*	265*	231	190	128	35			
22	-	305*	299*	277*	243	202	151	91		
24	-	-	307*	301*	280*	252	217	177	130	63

9316C3U-M16, 9316S3U-M16

METRIC UNITS

Hyd. Flow LPM	LPM at 2.1 BAR	LPM at 2.8 BAR	LPM at 3.4 BAR	LPM at 4.1 BAR	LPM at 4.8 BAR	LPM at 5.5 BAR	LPM at 6.2 BAR	LPM at 6.9 BAR	LPM at 7.6 BAR	LPM at 8.3 BAR
68.1	1056*	943	795	621	356					
75.7	1143*	1098*	1003*	874	719	485	132			
83.3	-	1155*	1132*	1049*	920	765	572	344		
90.8	-	-	1162*	1139*	1060*	954	821	670	492	238

*Flow rates can only be achieved with sufficient NPSHA (Net Positive Suction Head Available), refer to OIPM for details.

HYDRAULICALLY-DRIVEN, CAST IRON

Series 9307C



FEATURES:

- ◆ Hydraulic motor drive (for open center closed center and load-sensing systems)
- ◆ Port sizes: 3" NPT inlet, 2" NPT outlet
- ◆ 300 x 220 universal flange available (U)
- ◆ Max. fluid temperature: 140°F/60°C
- ◆ Impeller: stainless steel
- ◆ Motor: external gear
- ◆ Hydraulic ports: -10 SAE inlet and -12 SAE outlet
- ◆ Max. motor psi: 3000 (bar: 207)
- ◆ Pump seals: Life Guard silicon carbide standard
- ◆ Life Guard seals are the industry standard on OEM equipment
- ◆ Weight: 86 lbs./39 kg

FOR FLANGED CONNECTIONS YOU WILL ALSO NEED:

- Universal Flange Gasket Universal Flange Clamp

See 251 for details

ORDER INFORMATION

Model Number	Max GPM	Max LPM	Max PSI	Max BAR	Max Hyd. GPM	Max Hyd. LPM	Hydraulic Selection System
9307C-GM10	370	1400	135	9.3	20	75.7	Open/Closed
9307C-GM12	370	1400	135	9.3	23	87.1	Open/Closed
3430-0604	Life Guard silicon carbide seal kit						
9307CX	Pump head only, no hydraulic motor						

*Universal Flange (300 x 220) - Add Suffix "U" (i.e.: 9307C-GM10-U)

9307C-GM10, 9307C-GM10-U

U.S. UNITS

Hyd. Flow GPM	GPM at 30 PSI	GPM at 40 PSI	GPM at 50 PSI	GPM at 60 PSI	GPM at 70 PSI	GPM at 80 PSI	GPM at 90 PSI	GPM at 100 PSI	GPM at 110 PSI
16	282	253	219	168	73				
17	318	288	258	222	174	95			
18	346	318	291	258	222	166	90		
19	361	361	338	311	281	250	201	137	
20	370	370	351	328	301	275	241	184	106

9307C-GM10, 9307C-GM10-U

METRIC UNITS

Hyd. Flow LPM	LPM at 2.1 BAR	LPM at 2.8 BAR	LPM at 3.4 BAR	LPM at 4.1 BAR	LPM at 4.8 BAR	LPM at 5.5 BAR	LPM at 6.2 BAR	LPM at 6.9 BAR	LPM at 7.6 BAR
60.6	1067	958	829	636	276				
64.4	1204	1090	977	840	659	360			
68.1	1310	1204	1101	977	840	628	341		
71.9	1366	1366	1279	1177	1064	946	761	519	
75.7	1400	1400	1329	1241	1139	1041	912	696	401

9307C-GM12, 9307C-GM12-U

U.S. UNITS

Hyd. Flow GPM	GPM at 30 PSI	GPM at 40 PSI	GPM at 50 PSI	GPM at 60 PSI	GPM at 70 PSI	GPM at 80 PSI	GPM at 90 PSI	GPM at 100 PSI	GPM at 110 PSI
16	222	180	115						
17	246	212	166	92					
18	274	245	209	157	58				
19	302	272	242	203	150				
20	326	298	271	240	196	142			
21	345	324	297	269	238	194	140		
22		345	322	297	270	236	193	138	
23		370	344	323	299	273	235	194	137

9307C-GM12, 9307C-GM12-U

METRIC UNITS

Hyd. Flow LPM	LPM at 2.1 BAR	LPM at 2.8 BAR	LPM at 3.4 BAR	LPM at 4.1 BAR	LPM at 4.8 BAR	LPM at 5.5 BAR	LPM at 6.2 BAR	LPM at 6.9 BAR	LPM at 7.6 BAR
60.6	840	681	435						
64.4	931	802	628	348					
68.1	1037	927	791	594	220				
71.9	1143	1030	916	768	568				
75.7	1234	1128	1026	908	742	537			
79.5	1306	1226	1124	1018	901	734	530		
83.3		1306	1219	1124	1022	893	731	522	
87.1		1400	1302	1223	1132	1033	889	734	519

HYDRAULICALLY-DRIVEN, CAST IRON WITH FORCEFIELD TECHNOLOGY

Series 9307CWS



FOR FLANGED CONNECTIONS YOU WILL ALSO NEED:

- Universal Flange Gasket
 - Universal Flange Clamp
- See 251 for details

FEATURES:

- ◆ ForceField seal technology to protect your pump against today's harshest application environments:
 - Eliminates dry run failures
 - Eliminates chemical and fertilizer bonding failures
 - Prevents costly in-season downtime
 - Self-regulating, maintenance free chamber, provides pressure when needed and safe serviceability when it is not needed
 - Direct drop-in for current 9307 designs
- ◆ Components designed for today's high volume liquid fertilizer application on large capacity sprayers:
 - Hydraulic motor includes a case drain for maximum motor life
 - 316 stainless steel impeller
 - Two-piece shaft design includes 416 stainless steel wet end and 8620 hardened steel drive end
 - Bearings designed to handle continuous high volume pump loading



300 universal flange inlet x 220 universal flange outlet

One-year warranty that includes pump, motor and seals

ORDER INFORMATION

Model Number	Max GPM	Max LPM	Max PSI	Max BAR	Max Hyd. GPM	Max Hyd. LPM	Hydraulic Selection System
9307CWS-GM12	370	1400	135	9.8	23	87.1	Open/Closed
9307CWS-GM12-002 (NPT)	370	1400	135	9.8	23	87.1	Open/Closed
9307CWS-GM12-004 (90°)	370	1400	135	9.8	23	87.1	Open/Closed
9307CWS-GM12-005 (180°)	370	1400	135	9.8	23	87.1	Open/Closed
9307CWS-GM12-006 (270°)	370	1400	135	9.8	23	87.1	Open/Closed

9307CWS-GM12: PERFORMANCE IN WATER

U.S. UNITS

Hyd. Flow GPM	GPM at 30 PSI	GPM at 40 PSI	GPM at 50 PSI	GPM at 60 PSI	GPM at 70 PSI	GPM at 80 PSI	GPM at 90 PSI	GPM at 100 PSI	GPM at 110 PSI
16	222	180	115						
17	246	212	166	92					
18	274	245	209	157	58				
19	302	272	242	203	150				
20	326	298	271	240	196	142			
21	345	324	297	269	238	194	140		
22	345	345	322	297	270	236	193	138	
23	370	370	344	323	299	273	235	194	137

9307CWS-GM12: PERFORMANCE IN WATER

METRIC UNITS

Hyd. Flow LPM	LPM at 2.1 BAR	LPM at 2.8 BAR	LPM at 3.4 BAR	LPM at 4.1 BAR	LPM at 4.8 BAR	LPM at 5.5 BAR	LPM at 6.2 BAR	LPM at 6.9 BAR	LPM at 7.6 BAR
60.6	840	681	435						
64.4	931	802	628	348					
68.1	1037	927	791	594	220				
71.9	1143	1030	916	768	568				
75.7	1234	1128	1026	908	742	537			
79.5	1306	1226	1124	1018	901	734	530		
83.3	1306	1306	1219	1124	1022	893	731	522	
87.1	1400	1400	1302	1223	1132	1033	889	734	519

9307CWS-GM12: PERFORMANCE IN 28% LIQUID FERTILIZER

U.S. UNITS

Hyd. Flow GPM	GPM at 40 PSI	GPM at 50 PSI	GPM at 60 PSI	GPM at 70 PSI	GPM at 80 PSI	GPM at 90 PSI	GPM at 100 PSI	GPM at 110 PSI	GPM at 120 PSI	GPM at 130 PSI	GPM at 140 PSI
16	228	204	159	100							
17	234	219	190	147	49						
18	247	247	223	194	146	49					
19	255	255	239	221	191	151	55				
20	260	260	252	240	220	191	150	63			
21	260	260	254	248	237	224	196	159	87		
22	260	260	254	248	240	230	214	194	159	101	
23	260	260	254	249	249	242	237	227	211	174	133

9307CWS-GM12: PERFORMANCE IN 28% LIQUID FERTILIZER

METRIC UNITS

Hyd. Flow LPM	LPM at 2.8 BAR	LPM at 3.4 BAR	LPM at 4.1 BAR	LPM at 4.8 BAR	LPM at 5.5 BAR	LPM at 6.2 BAR	LPM at 6.9 BAR	LPM at 7.6 BAR	LPM at 8.3 BAR	LPM at 9.0 BAR	LPM at 9.7 BAR
60.6	863	772	602	379	-						
64.4	886	829	719	556	185						
68.1	935	935	844	734	553	185					
71.9	965	965	905	836	723	572	208				
75.7	984	984	954	908	833	723	568	238			
79.5	984	984	961	939	897	848	742	602	329		
83.3	984	984	961	939	908	871	810	734	602	382	
87.1	984	984	961	942	942	916	897	859	799	659	503

HYDRAULICALLY-DRIVEN, CAST IRON

Series 9308C



FEATURES:

- ◆ 5" ANSI-flanged inlet x 4" ANSI-flanged outlet
- ◆ 316 stainless steel impeller for superior corrosion resistance
- ◆ 9308 versions include a two-piece shaft design with a 416 stainless steel wet end and hardened 8620 drive end for extended life
- ◆ Life Guard silicon carbide seal for premium abrasion resistance and dry-run protection
- ◆ Life Guard seals are the industry standard on OEM equipment

ORDER INFORMATION

Model Number	Max GPM	Max LPM	Max PSI	Max BAR	Max Hyd GPM	Max Hyd LPM	Hydraulic Selection System
9308C-PM15	900	3407	58	4.0	16	60.6	Open/Closed
9308C-GM25	1078	4081	72	5.0	28	106	Open/Closed
9308CX	Pump head only						
3430-0604	Life Guard silicon carbide seal kit						

9308C-PM15

U.S. UNITS

Hyd. Flow GPM	GPM at 10 PSI	GPM at 20 PSI	GPM at 30 PSI	GPM at 40 PSI	GPM at 50 PSI
8	430				
12	656	656	416		
16	900	900	900	778	607

9308C-PM15

METRIC UNITS

Hyd. Flow LPM	LPM at 0.7 BAR	LPM at 1.4 BAR	LPM at 2.1 BAR	LPM at 2.8 BAR	LPM at 3.5 BAR
30.3	1628				
45.7	2483	2483	1575		
60.6	3407	3407	3407	2945	2298

9308C-GM25

U.S. UNITS

Hyd. Flow GPM	GPM at 20 PSI	GPM at 30 PSI	GPM at 40 PSI	GPM at 50 PSI	GPM at 60 PSI	GPM at 70 PSI
17	520					
23	828	828	667	296		
28	1078	1078	965	845	667	380

9308C-GM25

METRIC UNITS

Hyd. Flow LPM	LPM at 1.4 BAR	LPM at 2.1 BAR	LPM at 2.8 BAR	LPM at 3.5 BAR	LPM at 4.1 BAR	LPM at 4.8 BAR
64.3	1968					
87.1	3134	3134	2525	1120		
106	4081	4081	3653	3199	2525	1438

BELT-DRIVEN, CAST IRON, SELF-PRIMING

Series 9400C-SP



UPGRADE OPTIONS:

- ◆ Increase dry-run and abrasive resistance with Life Guard Seals
 - Life Guard seals are the OEM standard

FEATURES:

- ◆ Drive: 12-groove belt
- ◆ Spring-loaded belt tensioner
- ◆ Stainless steel wear ring
- ◆ Stainless steel pump shaft, standard
- ◆ Port sizes: 1-1/2" NPT inlet, 1-1/4" NPT outlet
- ◆ Max. fluid temperature: 140°F/60°C
- ◆ Housing: Cast iron
- ◆ Impeller: Nylon
- ◆ Pump shaft rotation: Counter clockwise when looking at shaft end
- ◆ Pump seals: Viton®/ceramic standard; Life Guard silicon carbide (B) available
- ◆ Life Guard seals are the industry standard on OEM equipment
- ◆ Weight: 57 lbs./25.9 kg

ORDER INFORMATION

Model Number	Max GPM	Max LPM	Max PSI	Max BAR	Max RPM	PTO Output
9403C-540-SP	120	454	99	6.8	600	1-3/8" female, 6 spline shaft
9403C-540Q-SP	120	454	99	6.8	600	1-3/8" 6 spline quick coupler
9403C-540S-SP	120	454	99	6.8	600	1" (25.4 mm) solid shaft
9403C-1000-SP	120	454	99	6.8	1000	1-3/8" female, 21-spline shaft
9403C-1000L-SP	120	454	99	6.8	1000	1-3/4" female, 20-spline shaft
3430-0332	Seal kit standard					
3430-0589	Life Guard silicon carbide seal kit					
3430-0480SP	Self priming chamber kit					

Life Guard silicon carbide seal - Add suffix "B" (i.e.: 9403C-540-SP-B)

9403C-540-SP

U.S. UNITS

RPM	GPM at 10 PSI	GPM at 20 PSI	GPM at 30 PSI	GPM at 40 PSI	GPM at 50 PSI	GPM at 60 PSI	GPM at 70 PSI	GPM at 80 PSI	GPM at 90 PSI
500	114	113	101	83	60	27			
540	120	119	116	102	85	62	32		
600	120	120	120	119	110	97	78	54	24

9403C-540-SP

METRIC UNITS

RPM	LPM at 0.7 BAR	LPM at 1.4 BAR	LPM at 2.1 BAR	LPM at 2.8 BAR	LPM at 3.4 BAR	LPM at 4.1 BAR	LPM at 4.8 BAR	LPM at 5.5 BAR	LPM at 6.2 BAR
500	432	428	382	314	227	102			
540	454	450	439	386	322	235	121		
600	454	454	454	450	416	367	295	204	91

9403C-1000-SP

U.S. UNITS

RPM	GPM at 10 PSI	GPM at 20 PSI	GPM at 30 PSI	GPM at 40 PSI	GPM at 50 PSI	GPM at 60 PSI	GPM at 70 PSI	GPM at 80 PSI	GPM at 90 PSI
800	111	109	94	74	47	21			
900	120	119	116	102	85	62	32		
1000	120	120	120	119	110	97	78	54	24

9403C-1000-SP

METRIC UNITS

RPM	LPM at 0.7 BAR	LPM at 1.4 BAR	LPM at 2.1 BAR	LPM at 2.8 BAR	LPM at 3.4 BAR	LPM at 4.1 BAR	LPM at 4.8 BAR	LPM at 5.5 BAR	LPM at 6.2 BAR
800	420	413	356	280	178	79			
900	454	450	439	386	322	235	121		
1000	454	454	454	450	416	367	295	204	91

Viton® is a registered trademark of DuPont. Hypro® is a registered trademark of Pentair.

BELT-DRIVEN, CAST IRON, POLYPROPYLENE & STAINLESS STEEL

Series 9400 Belt Drive



UPGRADE OPTIONS:

- ◆ Increase dry-run and abrasive resistance with Life Guard Seals
 - Life Guard seals are the OEM standard
- ◆ Extend pump life with Stainless Steel
 - Fact: Chemical corrosion, pump cavitation, and abrasive wear are key factors in pump life
 - 316 Stainless Steel pumps provide superior chemical corrosion resistance, while maintaining material strength to prolong the life against abrasive wear
 - 316 Stainless Steel resists cavitation pitting of pumps, extending the wear life
 - Drop in replacements for cast iron pumps

FEATURES:

- ◆ Available in cast iron, polypropylene and 316 stainless steel for extended pump life
- ◆ Drive: 12-groove belt
- ◆ Spring-loaded belt tensioner
- ◆ Stainless steel wear ring
- ◆ Stainless steel pump shaft, standard
- ◆ Port sizes: 9402 models - 1-1/4" NPT inlet, 1" NPT outlet; 9403 models - 1-1/2" NPT inlet, 1-1/4" NPT outlet
- ◆ 220 x 200 universal flange available (U)
- ◆ Max. fluid temperature: 140°F/60°C
- ◆ Impeller: Cast Iron models - Nylon; Poly & Stainless Steel models - Polypropylene
- ◆ Pump shaft rotation: Counter clockwise when looking at shaft end
- ◆ Pump seals: Viton®/ceramic standard; Life Guard silicon carbide (B) available
- ◆ Life Guard seals are the industry standard on OEM equipment
- ◆ Weight: 40-45 lbs./18.2-20.5 kg

FOR FLANGED CONNECTIONS YOU WILL ALSO NEED:

- Universal Flange Gasket
- Universal Flange Clamp

See 251 for details

ORDER INFORMATION

Model Number	Max GPM	Max LPM	Max PSI	Max BAR	Max RPM	PTO Output
9402C-540	76	283	95	6.5	600	1-3/8" female, 6-spline shaft
9402C-540Q	76	283	95	6.5	600	1-3/8" 6-spline quick coupler
9402C-540S	76	283	95	6.5	600	1" (25.4 mm) solid shaft
9402C-1000	76	283	95	6.5	1000	1-3/8" female, 21-spline shaft
9402C-1000L	76	283	95	6.5	1000	1-3/4" female, 20-spline shaft
9402C-1000S	76	283	95	6.5	1000	1" (25.4 mm) solid shaft
9403C-540†	140	530	104	7.2	600	1-3/8" female, 6-spline shaft
9403C-540Q†	140	530	104	7.2	600	1-3/8" 6-spline quick coupler
9403C-540S†	140	530	104	7.2	600	1" (25.4 mm) solid shaft
9403C-1000†	140	530	104	7.2	1000	1-3/8" female, 21-spline shaft
9403C-1000L†	140	530	104	7.2	1000	1-3/4" female, 20-spline shaft
9403C-1000-MTZ*	164	617	113	7.8	1000	38 mm female, 8-spline shaft
9403C-1000-MTZ-KIT*	Includes pump, Anti-rotation Kit and Vent Line kit					
9403C-1000S†	140	530	104	7.2	1000	1" (25.4 mm) solid shaft
9403P-540	91	344	83	5.7	600	1-3/8" female, 6-spline shaft
9403P-540Q	91	344	83	5.7	600	1-3/8" 6-spline quick coupler
9403P-540S	91	344	83	5.7	600	1" (25.4 mm) solid shaft
9403P-1000	86	326	83	5.7	1000	1-3/8" female, 21-spline shaft
9403P-1000L	86	326	83	5.7	1000	1-3/4" female, 20-spline shaft
9403P-1000S	86	326	83	5.7	1000	1" (25.4 mm) solid shaft
9403S-540	140	530	104	7.2	540	1-3/8" female, 6-spline shaft
9403S-540Q	140	530	104	7.2	540	1-3/8" 6-spline quick coupler
9403S-540S	140	530	104	7.2	540	1" (25.4 mm) solid shaft
9403S-1000	140	530	104	7.2	1000	1-3/8" female, 21-spline shaft
9403S-1000L	140	530	104	7.2	1000	1-3/4" female, 20-spline shaft
9403S-1000S	140	530	104	7.2	1000	1" (25.4 mm) solid shaft
3430-0332	Seal and o-ring repair kit					
3430-0476	Seal, o-ring, belt and gasket repair kit for 540 rpm drives					
3430-0477	Seal, o-ring, belt and gasket repair kit for 1000 rpm drives					
3430-0589	Life Guard silicon carbide seal kit					
3430-0333	Seal and o-ring repair kit (polypropylene)					
3430-0478	Seal, o-ring, belt and gasket repair kit for 540 rpm drives (polypropylene)					
3430-0479	Seal, o-ring, belt and gasket repair kit for 1000 rpm drives (polypropylene)					
3430-0590	Life Guard silicon carbide seal kit (polypropylene)					
3430-0796*	Anti-Rotation Kit for MTZ pump					

†Universal Flange (220 x 200) - Add Suffix "U" (i.e.: 9403C-1000S-U)

Life Guard silicon carbide seal - Add suffix "B" (i.e.: 9402C-540-B)

Available for order through Hypro-EU only (Cambridge, UK)

Viton® is a registered trademark of DuPont. Hypro® is a registered trademark of Pentair.

* For tractors MTZ 80 and 82.

BELT-DRIVEN, CAST IRON, POLYPROPYLENE & STAINLESS STEEL

Series 9400 Belt Drive

9402C-540

U.S. UNITS

RPM	GPM at 20 PSI	GPM at 30 PSI	GPM at 40 PSI	GPM at 50 PSI	GPM at 60 PSI	GPM at 70 PSI	GPM at 80 PSI	GPM at 90 PSI
450	61	58	50	36				
500	67	66	62	56	42			
540	71	71	70	65	58	44		
600	76	76	76	75	73	66	56	42

9402C-540

METRIC UNITS

RPM	LPM at 1.4 BAR	LPM at 2.1 BAR	LPM at 2.8 BAR	LPM at 3.4 BAR	LPM at 4.1 BAR	LPM at 4.8 BAR	LPM at 5.5 BAR	LPM at 6.2 BAR
450	231	220	189	136				
500	254	250	235	212	159			
540	269	269	265	246	220	167		
600	288	288	288	284	276	250	212	159

9402C-1000

U.S. UNITS

RPM	GPM at 20 PSI	GPM at 30 PSI	GPM at 40 PSI	GPM at 50 PSI	GPM at 60 PSI	GPM at 70 PSI	GPM at 80 PSI	GPM at 90 PSI	GPM at 100 PSI
800	68	67	64	57	41				
900	74	74	73	71	64	54	41		
1000	76	76	76	76	76	72	65	56	43

9402C-1000

METRIC UNITS

RPM	LPM at 1.4 BAR	LPM at 2.1 BAR	LPM at 2.8 BAR	LPM at 3.4 BAR	LPM at 4.1 BAR	LPM at 4.8 BAR	LPM at 5.5 BAR	LPM at 6.2 BAR	LPM at 6.9 BAR
800	257	254	242	216	155				
900	280	280	276	269	242	204	155		
1000	288	288	288	288	288	273	246	212	163

9403C-540, 9403S-540

U.S. UNITS

RPM	GPM at 20 PSI	GPM at 30 PSI	GPM at 40 PSI	GPM at 50 PSI	GPM at 60 PSI	GPM at 70 PSI	GPM at 80 PSI	GPM at 90 PSI	GPM at 100 PSI
450	107	99	86	50					
500	121	116	106	93	76	42			
540	129	127	120	111	98	80	50		
600	140	138	135	130	121	112	94	73	40

9403C-540, 9403S-540

METRIC UNITS

RPM	LPM at 1.4 BAR	LPM at 2.1 BAR	LPM at 2.8 BAR	LPM at 3.4 BAR	LPM at 4.1 BAR	LPM at 4.8 BAR	LPM at 5.5 BAR	LPM at 6.2 BAR	LPM at 6.9 BAR
450	405	375	326	189					
500	458	439	401	352	288	159			
540	488	481	454	420	371	303	189		
600	530	522	511	492	458	424	356	276	151

9403C-1000, 9403S-1000

U.S. UNITS

RPM	GPM at 20 PSI	GPM at 30 PSI	GPM at 40 PSI	GPM at 50 PSI	GPM at 60 PSI	GPM at 70 PSI	GPM at 80 PSI	GPM at 90 PSI	GPM at 100 PSI
800	115	106	96	80	56				
900	129	127	120	111	98	80	50		
1000	140	139	137	133	128	119	100	76	46

9403C-1000, 9403S-1000

METRIC UNITS

RPM	LPM at 1.4 BAR	LPM at 2.1 BAR	LPM at 2.8 BAR	LPM at 3.4 BAR	LPM at 4.1 BAR	LPM at 4.8 BAR	LPM at 5.5 BAR	LPM at 6.2 BAR	LPM at 6.9 BAR
800	435	401	363	303	212				
900	488	481	454	420	371	303	189		
1000	530	526	519	503	485	450	379	288	174

9403C-1000-MTZ

U.S. UNITS

RPM	GPM at 10 PSI	GPM at 20 PSI	GPM at 30 PSI	GPM at 40 PSI	GPM at 50 PSI	GPM at 60 PSI	GPM at 70 PSI	GPM at 80 PSI	GPM at 90 PSI	GPM at 100 PSI	GPM at 110 PSI
800	136	132	123	112	98	70	45				
900	150	149	145	135	125	115	97	72	35		
1000	163	162	160	155	150	140	130	115	95	75	45

9403C-1000-MTZ

METRIC UNITS

RPM	LPM at 0.7 Bar	LPM at 1.4 Bar	LPM at 2.1 Bar	LPM at 2.8 Bar	LPM at 3.4 Bar	LPM at 4.1 Bar	LPM at 4.8 Bar	LPM at 5.5 Bar	LPM at 6.2 Bar	LPM at 6.9 Bar	LPM at 7.6 Bar
800	515	500	466	424	371	265	170				
900	568	564	549	511	473	435	367	273	132		
1000	617	613	606	587	568	530	492	435	360	284	170

GAS ENGINE-DRIVEN POWERPRO, CAST IRON

Models 1521C-65, 1521C-65M



UPGRADE OPTIONS:

- ◆ Increase dry-run and abrasive resistance with Life Guard Seals
 - Life Guard seals are the OEM standard

FEATURES:

- ◆ PowerPro Engine (EPA & CARB certified)
- ◆ Closed coupled, gas engine-driven
- ◆ Max. fluid temperature: 140°F/60°C
- ◆ Housing: cast iron
- ◆ Impeller: Nylon
- ◆ Pump seals: Viton®/ceramic standard; Life Guard silicon carbide available
- ◆ Life Guard seals are the industry standard on OEM equipment
- ◆ Weight: 65 lbs./29.4kg

ORDER INFORMATION

Model Number	Max GPM	Max LPM	Max PSI	Max BAR	Port Size	Engine Mfgr. & HP
1521C-65	110	416	80	5.5	1-1/2" x 1-1/4"	PowerPro 6.5 hp
1521C-65M	Same as 1521C-65 with mounting base					
1538	1-1/2" x 1-1/4" centrifugal pump. DOES NOT include Engine. (must use 5/8" threaded shaft engine)					
3430-0332	Seal and o-ring repair kit					
3430-0589	Life Guard silicon carbide seal kit					

1521C-65, 1521C-65M

U.S. UNITS

GPM at 10 PSI	GPM at 20 PSI	GPM at 30 PSI	GPM at 40 PSI	GPM at 50 PSI	GPM at 60 PSI	GPM at 70 PSI
110	106	96	88	80	60	30

1521C-65, 1521C-65M

METRIC UNITS

LPM at 0.7 BAR	LPM at 1.4 BAR	LPM at 2.1 BAR	LPM at 2.8 BAR	LPM at 3.4 BAR	LPM at 4.1 BAR	LPM at 4.8 BAR
416	401	363	333	303	227	114

GAS ENGINE-DRIVEN POWERPRO, CAST IRON

Models 1552C-130, 1522C-130E



FEATURES:

- ◆ PowerPro Engine (EPA & CARB certified)
- ◆ Closed coupled, gas engine-driven
- ◆ Max. fluid temperature: 140°F/60°C
- ◆ Housing: cast iron
- ◆ Impeller: Nylon
- ◆ Pump seals: Viton®/ceramic standard
- ◆ Weight: 110 lbs./50kg

ORDER INFORMATION

Model Number	Max GPM	Max (LPM)	Max PSI	Max BAR	Port Size	Engine Mfgr. & HP
1552C-130	170	644	150	10.3	2" x 1-1/2"	PowerPro 13 hp
1552C-130E	170	644	150	10.3	2" x 1-1/2"	PowerPro 13 hp w/ electric start
1551	2" x 1-1/2" centrifugal pump kit. DOES NOT include engine. (must use 1" threaded shaft engine)					
3430-0464	Seal and o-ring repair kit					
3430-0779	Silicon carbide seal kit					

1552C-130, 1552C-130E

U.S. UNITS

GPM at 20 PSI	GPM at 40 PSI	GPM at 60 PSI	GPM at 80 PSI	GPM at 100 PSI	GPM at 120 PSI	GPM at 140 PSI
170	166	148	120	92	65	35

1552C-130, 1552C-130E

METRIC UNITS

LPM at 1.4 BAR	LPM at 2.8 BAR	LPM at 4.1 BAR	LPM at 5.5 BAR	LPM at 6.9 BAR	LPM at 8.3 BAR	LPM at 9.7 BAR
644	628	560	454	348	246	132

Viton® is a registered trademark of DuPont. Hypro® is a registered trademark of Pentair.

GAS ENGINE-DRIVEN POWERPRO, CAST IRON, SELF-PRIMING

Models 1522C-65SP



UPGRADE OPTIONS:

- ◆ Increase dry-run and abrasive resistance with Life Guard Seals
 - Life Guard seals are the OEM standard

FEATURES:

- ◆ PowerPro Engine (EPA & CARB certified)
- ◆ Closed coupled, gas engine-driven
- ◆ Max. fluid temperature: 140°F/60°C
- ◆ Housing: cast iron
- ◆ Impeller: Nylon
- ◆ Pump seals: Viton®/ceramic standard; Life Guard silicon carbide available
- ◆ Life Guard seals are the industry standard on OEM equipment
- ◆ Fill Port 3/4" NPT

ORDER INFORMATION

Model Number	Max GPM	Max LPM	Max PSI	Max BAR	Port Size	Engine Mfg. & HP
1522C-65SP	130	492	65	4.5	2" x 2"	PowerPro 6.5 hp
1538-SP*	2" x 2" centrifugal pump kit. does not include engine. (must use 5/8" threaded shaft engine)					
3430-0332	Seal and o-ring repair kit					
3430-0589	Life Guard silicon carbide seal kit					

* Must use 5/8" threaded shaft engine.

1522C-65SP

U.S. UNITS

GPM at 0 PSI	GPM at 10 PSI	GPM at 20 PSI	GPM at 30 PSI	GPM at 35 PSI	GPM at 40 PSI	GPM at 50 PSI	GPM at 60 PSI	GPM at 65 PSI
130	121	108	93	85	76	56	34	0

1522C-65SP

METRIC UNITS

LPM at 0 BAR	LPM at 0.7 BAR	LPM at 1.4 BAR	LPM at 2.1 BAR	LPM at 2.4 BAR	LPM at 2.8 BAR	LPM at 3.4 BAR	LPM at 4.1 BAR	LPM at 4.5 BAR
492	458	409	352	322	288	212	129	0

GAS ENGINE-DRIVEN POWERPRO, CAST IRON, SELF-PRIMING

Models 1552C-130SP, 1552C-130ESP



FEATURES:

- ◆ PowerPro Engine (EPA & CARB certified)
- ◆ Closed coupled, gas engine-driven
- ◆ Max. fluid temperature: 140°F/60°C
- ◆ Housing: cast iron
- ◆ Impeller: Nylon
- ◆ Pump seals: Viton®/ceramic standard
- ◆ Fill Port 1" NPT

ORDER INFORMATION

Model Number	Max GPM	Max LPM	Max PSI	Max BAR	Port Size	Engine Mfg. & HP
1552C-130SP	163	617	147	10.1	2" x 2"	PowerPro 13 hp
1552C-130ESP	163	617	147	10.1	2" x 2"	PowerPro 13 hp w/ electric start
1551-SP*	2" x 2" centrifugal pump kit. Does not include engine. (must use 1" threaded shaft engine)					
1551-BSP*	2" x 2" centrifugal pump kit. (BSP threads) Does not include engine.					
3430-0464	Seal and o-ring repair kit					
3430-0779	Silicon carbide seal kit					

* Must use 1" threaded shaft engine.

1552C-130SP, 1552C-130ESP

U.S. UNITS

GPM at 20 PSI	GPM at 40 PSI	GPM at 60 PSI	GPM at 80 PSI	GPM at 100 PSI	GPM at 120 PSI	GPM at 140 PSI	GPM at 147 PSI
163	161	148	122	100	75	51	0

1552C-130SP, 1552C-130ESP

METRIC UNITS

LPM at 0 BAR	LPM at 1.4 BAR	LPM at 2.8 BAR	LPM at 4.1 BAR	LPM at 5.5 BAR	LPM at 6.9 BAR	LPM at 8.3 BAR	LPM at 9.7 BAR	LPM at 10.1 BAR
617	609	560	462	379	284	193	102	0

GAS ENGINE-DRIVEN, CAST IRON

Models 1536 and 1539



UPGRADE OPTIONS:

- ◆ Increase dry-run and abrasive resistance with Life Guard Seals
 - Life Guard seals are the OEM standard

FEATURES:

- ◆ Briggs & Stratton® engine (EPA & CARB certified)
- ◆ Close-coupled, gas engine-driven
- ◆ Max. fluid temperature: 140°F/60°C
- ◆ Housing: cast iron
- ◆ Impeller: Nylon
- ◆ Pump seals: Viton®/ceramic standard; Life Guard silicon carbide available
- ◆ Life Guard seals are the industry standard on OEM equipment
- ◆ Weight: 53 lbs./24.1 kg

ORDER INFORMATION

Model Number	Max GPM	Max LPM	Max PSI	Max BAR	Port Size	Engine Mfg. & HP
1536	110	416	75	5.2	1-1/2" x 1-1/4"	Briggs & Stratton® 5.5 hp
1539	Same as model 1536 without mounting base					
1538*	1-1/2" x 1-1/4" centrifugal pump kit. DOES NOT include engine. (must use 5/8" threaded shaft engine)					
3430-0332	Seal and o-ring repair kit					
3430-0589	Life Guard silicon carbide seal kit					

* Must use 5/8" threaded shaft engine.

1536, 1539

U.S. UNITS					
GPM at 10 PSI	GPM at 20 PSI	GPM at 30 PSI	GPM at 40 PSI	GPM at 50 PSI	GPM at 60 PSI
110	106	96	87	73	50

1536, 1539

METRIC UNITS					
LPM at 0.7 BAR	LPM at 1.4 BAR	LPM at 2.1 BAR	LPM at 2.8 BAR	LPM at 3.4 BAR	LPM at 4.1 BAR
416	401	363	329	276	189

Briggs & Stratton® is a registered trademark of Briggs & Stratton Corporation.

GAS ENGINE-DRIVEN, CAST IRON

Models 1537 and 1540



UPGRADE OPTIONS:

- ◆ Increase dry-run and abrasive resistance with Life Guard Seals
 - Life Guard seals are the OEM standard

FEATURES:

- ◆ Honda® engine (EPA & CARB certified)
- ◆ Close-coupled, gas engine-driven
- ◆ Max. fluid temperature: 140°F/60°C
- ◆ Housing: cast iron
- ◆ Impeller: Nylon
- ◆ Pump seals: Viton®/ceramic standard; Life Guard silicon carbide available
- ◆ Life Guard seals are the industry standard on OEM equipment
- ◆ Weight: 53 lbs./24.1 kg

ORDER INFORMATION

Model Number	Max GPM	Max LPM	Max PSI	Max BAR	Port Size	Engine Mfg. & HP
1537	110	416	80	5.5	1-1/2" x 1-1/4"	Honda® 5.5 hp
1540	Same as model 1537 without mounting base					
1538*	1-1/2" x 1-1/4" centrifugal pump kit. DOES NOT include engine. (must use 5/8" threaded shaft engine)					
3430-0332	Seal and o-ring repair kit					
3420-0589	Life Guard silicon carbide seal kit					

* Must use 5/8" threaded shaft engine.

1537, 1540

U.S. UNITS						
GPM at 10 PSI	GPM at 20 PSI	GPM at 30 PSI	GPM at 40 PSI	GPM at 50 PSI	GPM at 60 PSI	GPM at 70 PSI
110	106	96	88	80	60	30

1537, 1540

METRIC UNITS						
LPM at 0.7 BAR	LPM at 1.4 BAR	LPM at 2.1 BAR	LPM at 2.8 BAR	LPM at 3.4 BAR	LPM at 4.1 BAR	LPM at 4.8 BAR
416	401	363	333	303	227	114

Viton® is a registered trademark of DuPont.

GAS ENGINE-DRIVEN, CAST IRON, SELF-PRIMING

Models 1536-SP and 1539-SP



UPGRADE OPTIONS:

- ◆ Increase dry-run and abrasive resistance with Life Guard Seals
 - Life Guard seals are the OEM standard

FEATURES:

- ◆ Briggs & Stratton® engine (EPA & CARB certified)
- ◆ Max. fluid temperature: 140°F/60°C
- ◆ Housing: cast iron
- ◆ Impeller: Nylon
- ◆ Pump seals: Viton®/ceramic standard; Life Guard silicon carbide available
- ◆ Life Guard seals are the industry standard on OEM equipment
- ◆ Fill Port 3/4" NPT
- ◆ Weight: 72 lbs./32.7 kg

ORDER INFORMATION

Model Number	Max GPM	Max LPM	Max PSI	Max BAR	Port Size	Engine Mfrg. & HP
1536-SP	100	379	65	4.5	2" x 2"	Briggs & Stratton® 5.5 hp
1539-SP	Same as model 1536-SP without mounting base					
1538-SP*	2" x 2" centrifugal pump kit. DOES NOT include engine. (must use 5/8" threaded shaft engine)					
3430-0332	Seal kit standard					
3430-0482SP	Self-primer conversion kit					
3430-0589	Life Guard silicon carbide seal kit					

* Must use 5/8" threaded shaft engine.

1536-SP, 1539-SP

U.S. UNITS

GPM at 10 PSI	GPM at 20 PSI	GPM at 30 PSI	GPM at 40 PSI	GPM at 50 PSI	GPM at 60 PSI
92	81	67	55	40	15

1536-SP, 1539-SP

METRIC UNITS

LPM at 0.7 BAR	LPM at 1.4 BAR	LPM at 2.1 BAR	LPM at 2.8 BAR	LPM at 3.4 BAR	LPM at 4.1 BAR
348	307	254	208	151	57

Briggs & Stratton® is a registered trademark of Briggs & Stratton Corporation.

GAS ENGINE-DRIVEN, CAST IRON, SELF-PRIMING

Models 1537-SP and 1540-SP



UPGRADE OPTIONS:

- ◆ Increase dry-run and abrasive resistance with Life Guard Seals
 - Life Guard seals are the OEM standard

FEATURES:

- ◆ Honda® engine (EPA & CARB certified)
- ◆ Max. fluid temperature: 140°F/60°C
- ◆ Housing: cast iron
- ◆ Impeller: Nylon
- ◆ Pump seals: Viton®/ceramic standard; Life Guard silicon carbide available
- ◆ Life Guard seals are the industry standard on OEM equipment
- ◆ Fill Port 3/4" NPT

ORDER INFORMATION

Model Number	Max GPM	Max LPM	Max PSI	Max BAR	Port Size	Engine Mfrg. & HP
1537-SP	106	401	75	5.2	2" x 2"	Honda® 5.5 hp
1540-SP	Same as model 1537-SP without mounting base					
1538-SP*	2" x 2" centrifugal pump kit. DOES NOT include engine. (must use 5/8" threaded shaft engine)					
3430-0332	Seal kit standard					
3430-0482SP	Self-primer conversion kit					
3430-0589	Life Guard silicon carbide seal kit					

* Must use 5/8" threaded shaft engine.

1537-SP, 1540-SP

U.S. UNITS

GPM at 10 PSI	GPM at 20 PSI	GPM at 30 PSI	GPM at 40 PSI	GPM at 50 PSI	GPM at 60 PSI
98	87	73	60	44	21

1537-SP, 1540-SP

METRIC UNITS

LPM at 0.7 BAR	LPM at 1.4 BAR	LPM at 2.1 BAR	LPM at 2.8 BAR	LPM at 3.4 BAR	LPM at 4.1 BAR
371	329	276	227	167	79

Viton® is a registered trademark of DuPont.

55

Honda® is a registered trademark of Honda Motor Co., Ltd.
Hypro is a registered trademark of Pentair.

GAS ENGINE-DRIVEN, CAST IRON

Series 1550



FEATURES:

- ◆ Honda® engine (EPA & CARB certified)
- ◆ Close-coupled, gas engine-driven
- ◆ Max. fluid temperature: 140°F/60°C
- ◆ Housing: cast iron
- ◆ Pump seals: Viton®/ceramic
- ◆ Impeller: Nylon
- ◆ Weight: 105 lbs./47.7 kg; SP and BSP: 125 lbs./56.8 kg

ORDER INFORMATION

Model Number	Max GPM	Max LPM	Max PSI	Max BAR	Port Size	Engine Mfgr. & HP	Self Priming
1550	150	568	140	9.7	2" x 1-1/2"	Honda® 9 hp	No
1550-SP	155	587	135	9.3	2" x 2"	Honda® 9 hp	Yes
1550-BSP†	155	587	135	9.3	2" x 2"	Honda® 9 hp	Yes
1551*	2" x 1-1/2" centrifugal pump kit. DOES NOT include engine. (must use 1" threaded shaft engine)						
1551-SP*	2" x 2" centrifugal pump kit. DOES NOT include engine. (must use 1" threaded shaft engine)						
3430-0464	Seal, o-ring, and gasket repair kit						
3430-0779	Life Guard silicon carbide seal kit						

* Must use 1" threaded shaft engine. † BSP Threads

1550

U.S. UNITS

GPM at 20 PSI	GPM at 40 PSI	GPM at 60 PSI	GPM at 80 PSI	GPM at 100 PSI	GPM at 120 PSI	GPM at 140 PSI
145	130	107	87	69	45	16

1550

METRIC UNITS

LPM at 1.4 BAR	LPM at 2.8 BAR	LPM at 4.1 BAR	LPM at 5.5 BAR	LPM at 6.9 BAR	LPM at 8.3 BAR	LPM at 9.7 BAR
549	492	405	329	261	170	61

1550-SP, 1550-BSP

U.S. UNITS

GPM at 10 PSI	GPM at 20 PSI	GPM at 40 PSI	GPM at 60 PSI	GPM at 80 PSI	GPM at 100 PSI	GPM at 120 PSI
145	141	118	93	71	49	28

1550-SP, 1550-BSP

METRIC UNITS

LPM at 0.7 BAR	LPM at 1.4 BAR	LPM at 2.1 BAR	LPM at 2.8 BAR	LPM at 3.4 BAR	LPM at 4.1 BAR	LPM at 4.8 BAR
549	534	447	352	269	185	106

Viton® is a registered trademark of DuPont.
 Honda® is a registered trademark of Honda Motor Co., Ltd.
 Hypro is a registered trademark of Pentair.

UNDERSTANDING MECHANICAL SEAL OPTIONS

STANDARD

Industry tested and proven



COMMON USES

Less demanding applications; minimal dry run or abrasive solution

HOW IT WORKS

Mechanical seals depend on their seal face conditions of flatness and finish to maintain their sealing function while allowing the shaft to rotate. A spring ensures the seal faces stay in contact to prevent leaking. Elastomers are mated with adjacent shaft and housing components to complete the sealing system.

MATERIAL

Carbon on Ceramic

PRO

- ◆ Dependable life when protected from dry run and abrasives
- ◆ Least expensive option

CON

- ◆ Minimal dry run resistance
- ◆ Limited service life in abrasive solutions
- ◆ Susceptible to chemical & fertilizer bonding failures

LIFE GUARD

The OEM standard



COMMON USES

Suited for broad spraying applications including abrasive solutions

ADVANTAGES OVER STANDARD

The hardness of Silicon Carbide approaches that of diamond and allows the seal to have outstanding service life when pumping abrasive solutions. Carbon graphite flakes are embedded into the silicon carbide faces to increase lubricity and provide survivability against incidental dry run and thermal shock.

MATERIAL

Silicon Carbide

PRO

- ◆ Extended service life in abrasive solutions
- ◆ Enhanced dry run resistance
- ◆ Drop-in replacement for standard seal

CON

- ◆ Does not eliminate dry run failure
- ◆ Susceptible to chemical & fertilizer bonding failures
- ◆ Increased cost

FORCEFIELD TECHNOLOGY

The premium choice



COMMON USES

Applications where downtime must be avoided.

ADVANTAGES OVER LIFE GUARD

ForceField wet seal technology protects seals by using a barrier fluid to keep them cool and lubricated, even while the pump is running dry. ForceField technology actively maintains a positive pressure differential between the chamber barrier fluid and the pumping solution, which prevents chemical bonding of the seal faces. The result is increased life and maintenance free operation.

MATERIAL

Carbon on Silicon

PRO

- ◆ Eliminates dry run failure
- ◆ Prevent chemical & fertilizer bonding failures
- ◆ Maintenance-free operation
- ◆ Warranted for one full year

CON

- ◆ Increased cost

LIFE GUARD SILICON CARBIDE PUMP SEALS

Specially designed to prolong seal life



SIDE BY SIDE COMPARISON

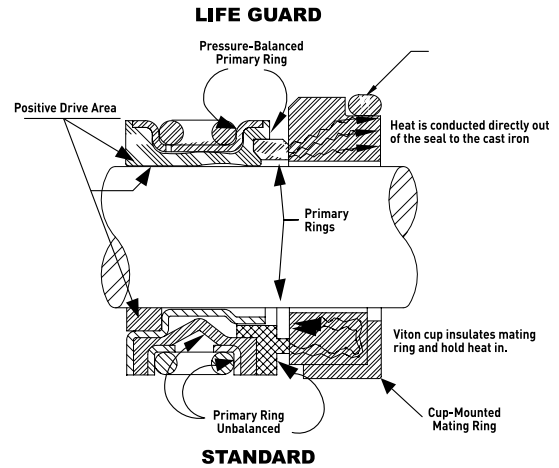

The drawing to the right represents a cross sectional view of a Life Guard Premium Silicon Carbide Seal (top) and a standard seal (bottom). There are three key differences shown in the drawing: material, mating rings and balance.

MATERIAL:

The Life Guard seal utilizes silicon carbide (SiC) for its seal surfaces (primary ring and mating ring). This is more abrasion resistant than the carbon graphite and ceramic used in standard seals. SiC also runs cooler if the pump is run dry, improving the life of the seal.

MATING RINGS:

The O-ring style of the Life Guard seal mating ring allows heat to dissipate into the pump casting. This keeps the seal at a lower temperature and dramatically improves the chances of the seal to survive a dry-run episode.

BALANCE:

The bellows and primary ring of the Life Guard seal are pressure balanced. This results in cooler operation at higher pressures.

Life Guard silicon carbide seals are available in the following models: Pedestal mount, Flange mount, Clutch-driven, Hydraulically-driven, Belt-driven, and Gas Engine-driven.

LIFE TEST IN ABRASIVE SOLUTION

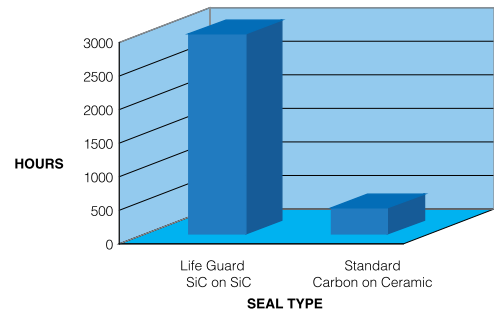

DRY-RUN SURVIVABILITY (5 MINUTES/CYCLE)

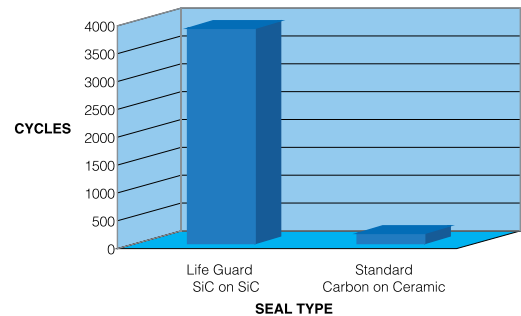

LIFE GUARD SILICON CARBIDE SEAL KITS

Part Number	Pump Series/Model #	Size		Description	Estimated Weight Ea.
		US	Metric		
3430-0589	9200, 9300 and 9400 Cast and Stainless	5/8"	15.9 mm	Mechanical seal and o-ring	4 oz./114 g
3430-0593	9303P	5/8"	15.9 mm	Mechanical seal, o-ring, gasket and washer for under acorn nut	4 oz./114 g
3430-0601	9305C and 9305C-SP	5/8"	15.9 mm	Mechanical seal and o-ring	4 oz./114 g
3430-0590	All Poly Models	3/4"	19 mm	Mechanical seal, o-ring, gasket and washer for under acorn nut	4 oz./114 g
3430-0604	9307 Series	1-3/8"	35 mm	Mechanical seal, o-ring and gasket	4 oz./114 g
3430-0646	9205 Models	3/4"	19 mm	Mechanical seal and o-ring	4 oz./114 g
3430-0591	9000C-0 and 9000C-0-SP	3/4"	19 mm	Mechanical seal and o-ring	4 oz./114 g

SELF-PRIMING ADAPTOR (SPA)

Provides Fast Self-Priming for Closed Impeller Centrifugal Pumps



FEATURES:

- ◆ Creates self-priming capability for all standard centrifugal pump models
- ◆ Increases priming efficiency over open impeller transfer pumps and self-priming centrifugal pumps
- ◆ Allows the use of a single, high efficiency pump for both tank filling and spraying
- ◆ Constructed out of 304 stainless steel for corrosion resistance
- ◆ Protects the pump's mechanical seal from dry-run during priming operations for on-board loading
- ◆ Guards against unexpected dry-run conditions during spraying application, if system were to function automatically
- ◆ Allows centrifugal pumps to be mounted in tight-fitting configurations while maintaining priming and flow performance capabilities
- ◆ SPA can be mounted in nearby remote location up to 10 ft (3 m) from pump

ORDER INFORMATION

Model Number	Description
1530-0024S	2" NPT Self-Priming Adaptor
1530-0028S	2" NPT High Volume Self-Priming Adaptor
3430-0700	Mounting Kit

SELF-PRIMING ADAPTOR CONFIGURATION

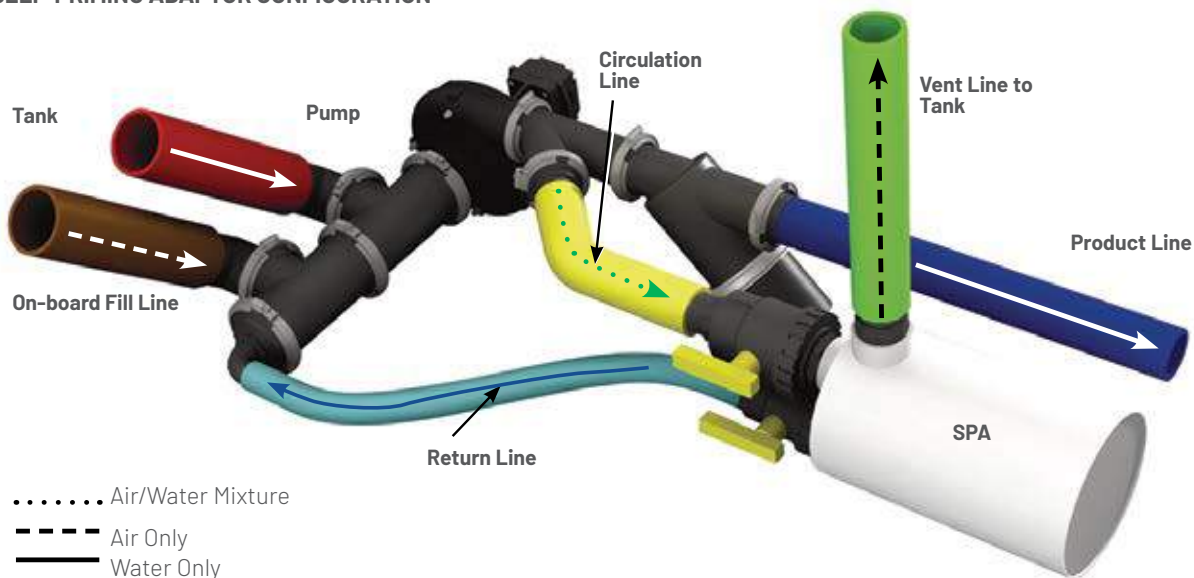

HOW THE SELF-PRIMING ADAPTOR WORKS

To facilitate pump priming, liquid is circulated through the pump and eye of the impeller. The attached Self-Priming Adaptor (SPA) stores an initial amount of liquid for the priming operation. The SPA, when activated with two ball valves, separates the air from the liquid being circulated and releases it back to the atmosphere through the vent line. Only liquid returns back to the pump inlet, thereby eliminating the inlet suction line of air. Once the pump is primed, pump pressure and flow increases. Flow is directed to the tank. The operator then closes the two ball valves, shutting off the circulation path between the pump and SPA.

CENTRIFUGAL PUMP ACCESSORIES

FORCEFIELD REPLACEMENT FLUID

Part Number	Description
2160-0096	Replacement fluid (pre-mixed) for ForceField seal chamber- 23oz.

HYDRAULIC PORT ADAPTERS



Part Number	Description
3360-0021A	1/2" NPT Pressure Port Adapter
3430-0187	1/2" NPT Pressure Port Adapter with metering orifices
3320-0051A	3/4" NPT Tank Port Adapter
3320-0052A	SAE-10 (o-ring) Tank Port Adapter
3360-0023A	SAE-10 (o-ring) Pressure Port Adapter
3320-0077	M30x2.0 Pressure Port Adapter
3360-0027	M30x2.0 Tank Port Adapter

12 VOLT CLUTCH



Part Number	Shaft Size	Pulley Type	Max. HP	Max. RPM	Max. AMPS @ 12V	Pump Model	Est. Weight Ea.
2526-0011	7/8" (19 mm)	5.25" (140 mm)-A	30	5000	4.85	9203P-S, 9253P-C, 9205C, 9205C-SP	8 lbs./3.6kg
3430-0592	5/8" (15.9 mm)	5.00" (125 mm) Double Groove-A	30	5000	3.75	9202C, 9203C, 9206C, 9203C-R, 9262C-C, 9263C-C, 9263C-CR, 9203C-SP, 9262S-C, 9263S-C, 9263S-CR, 9263C-C-SP, 9263C-CR-SP	9 lbs./4.1kg

VENT LINE KIT



Part Number	Description	Est. Weight Ea.
3430-0456	Vent line kit with 25' (6.3 m) long, 1/4" ID vinyl hose, 1/8" NPT x 1/4" HB 90° nylon elbow fitting, 1/8" NPT x 1/4" HB straight polypropylene fitting, plastic hose clamp and plastic cable tie. Works with all Hypro centrifugals.	14 oz./397g
3430-0797	Push-to-connect vent line kit with 25' (6.3 m) long, 1/4" polyethylene tubing, 1/8" MNPT x 1/4" push-to-connect straight, 1/8" MNPT x 1/4" push-to-connect 90° elbow, and plastic cable ties. Works with all Hypro centrifugal pumps.	14 oz./397g

PTO MOUNTING CLIPS



Part Number	Pump Series	Est. Weight Ea.
1520-0034	9000C-0 (not for 9040 Series)	4 lbs./1.8 kg

HYDRAULIC TEST KIT



Part Number	Description	Est. Weight Ea.
3430-0650	Hydraulic test kit with pressure and tank fixtures with flow meter and digital pressure gauges. Works with all Hypro HM series motors.	20 lbs./9.1 kg

CENTRIFUGAL PUMP REPAIR TOOLS

Part Number	Pump Series	Description
3010-0061	9000	Main bearing support tool
3010-0064	9000, 9200, 9300	Support bar/sleeve extractor
3010-0066	9200, 9300	Wire brush
3010-0067	9200, 9300	Wire brush holder
3010-0084	9000, 9200, 9300	Internal/external retaining ring pliers
3010-0167	9000, 9300	Internal/external retaining ring pliers
3010-0168	9000, 9200, 9300	Tool box
3020-0008	9300	Allen wrench; 1/4" hex
3020-0009	9200, 9300	Allen wrench; 1/16" hex
3430-0650	9300	Hydraulic test kit

TRANSFER PUMP SELECTION

MATERIAL OPTIONS

ALUMINUM



TYPICAL USE:
Water Transfer

The aluminum construction does not lend itself well to chemical transfer.

OPTIONS INCLUDE:
2" and 3" semi-trash and 3" trash

CAST IRON



TYPICAL USE:
Liquid Fertilizer Transfer

Cast iron transfer pumps have thicker castings and stand up well to high density liquid fertilizers.

OPTIONS INCLUDE:
2" and 3" models available

POLYPROPYLENE



TYPICAL USE:
Chemical Transfer

Polypropylene has excellent corrosion resistance to virtually all Agricultural chemicals.

OPTIONS INCLUDE:
2" and 3" models available

DRIVE OPTIONS

GAS ENGINE



TYPICAL USE:
Outdoor applications in a mobile environment such as on a sprayer nurse/tender trailer.

HYDRAULIC MOTOR



TYPICAL USE:
Applications where a smaller footprint is desired and hydraulic power is available.

ELECTRIC MOTOR



TYPICAL USE:
Indoor and outdoor stationary applications where electrical power is available.

POLYPROPYLENE, GAS ENGINE-DRIVEN, 2 IN. & 3 IN.

1542P and 1543P



1542P-65SP



1543P-130SP

FEATURES:

- ◆ Multiple gas engine options, including field proven Hypro PowerPro, Honda® and Hypro® PowerPro and Honda® engines (EPA & CARB certified - North America; EC/CE Listed - Europe)
- ◆ Housings: 2" x 2" Polypropylene or 3" x 3" polypropylene - highest performance available in a 3" transfer pump with highest efficiency and horsepower on the market
- ◆ Pump Seals: EPDM standard, Viton optional - contact factory
- ◆ Suction Lift: 25 ft./7.62 m
- ◆ Poly impeller with stainless steel insert (3"); Nylon impeller (2")
- ◆ 2" versions available with or without frame

ORDER INFORMATION 2" GAS ENGINE-DRIVEN

Model Number	Max GPM	Max LPM	Max PSI	Max BAR	Port Size	Impeller Profile	Engine Mfgr. & HP
1542P-65SP	200	757	58	4.0	2" x 2" NPT	5 vane	PowerPro 6.5 hp
1542P-65USP	200	757	58	4.0	2" x 2" Flange	5 vane	PowerPro 6.5 hp
1542P-65SPM	200	757	58	4.0	2" x 2" NPT	5 vane	PowerPro 6.5 hp with frame
1542P-65ESP	200	757	58	4.0	2" x 2" NPT	5 vane	PowerPro 6.5 hp w/ elec. start
1542PV-65SP	200	757	58	4.0	2" x 2" w. Viton	5 vane	PowerPro 6.5 hp
1442P-65SP	200	757	58	4.0	2" x 2" NPT	5 vane	6.5 HP EC/CE listed
1542P-160HSP	200	757	58	4.0	2" x 2" NPT	5 vane	Honda® GX160
1542P-160HUSP	200	757	58	4.0	2" x 2" Flange	5 vane	Honda® GX160
1542P-200HSP	200	757	58	4.0	2" x 2" NPT	5 vane	Honda® GX200
1542P-55SP	150	568	58	4.0	2" x 2" NPT	3 vane	PowerPro 6.5 hp
3410-0041	Cam lock kit						
3430-0690	Pump head kit for 1542P-55SP with EPDM seal (3 vane impeller)						
3430-0691	Pump head kit for 1542P-65SP with EPDM seal (5 vane impeller)						
3430-0839	Pump head kit for 1542P-65SP with Viton seal (5 vane impeller)						
3430-0946	Pump head kit for 1542P-65USP with 2" flanged ports.						
3430-0635	EPDM seal kit						
3430-0659	Viton seal kit						

1542P-55SP

U.S. UNITS

GPM at 0 PSI	GPM at 10 PSI	GPM at 20 PSI	GPM at 30 PSI	GPM at 40 PSI	GPM at 50 PSI	GPM at 58 PSI
150	147	131	108	80	48	0

1542P-55SP

METRIC UNITS

LPM at 0 BAR	LPM at 0.7 BAR	LPM at 1.4 BAR	LPM at 2.1 BAR	LPM at 2.8 BAR	LPM at 3.4 BAR	LPM at 4.0 BAR
568	556	496	409	303	182	0

1542P-65SP, 1542P-200HSP, 1542P-160HSP, 1542P-160HUSP, 1542P-65USP U.S. UNITS

GPM at 0 PSI	GPM at 10 PSI	GPM at 20 PSI	GPM at 30 PSI	GPM at 40 PSI	GPM at 50 PSI	GPM at 58 PSI
200	182	162	136	106	65	0

1542P-65SP, 1542P-200HSP, 1542P-160HSP, 1542P-160HUSP, 1542P-65USP METRIC UNITS

LPM at 0 BAR	LPM at 0.7 BAR	LPM at 1.4 BAR	LPM at 2.1 BAR	LPM at 2.8 BAR	LPM at 3.4 BAR	LPM at 4.0 BAR
757	689	613	515	401	246	0

ORDER INFORMATION 3" GAS ENGINE-DRIVEN

Model Number	Max GPM	Max LPM	Max PSI	Max BAR	Port Size	Impeller Profile	Engine Mfgr. & HP
1543P-130SP	440	1666	54	3.7	3" x 3" NPT	5 vane	PowerPro 13 HP
1543P-130ESP	440	1666	54	3.7	3" x 3" NPT	5 vane	PowerPro 13 HP w/ elec. start
1543P-130ESP-01	440	1666	54	3.7	3"x3"FLANGE	5 vane	PowerPro 13 HP w/ elec. start
1543P-390EHSP	440	1666	54	3.7	3"x3"NPT	5 vane	Honda® GX390 w/ elec. start
1543P-390EHUSP	440	1666	54	3.7	3"x3"FLANGE	5 vane	Honda® GX390 w/ elec. start
3410-0042	Cam lock kit						
3430-0692	Pump head kit with EPDM seal						
3430-0692-02	Pump head kit with EPDM seal and 3" UF Fittings						
3430-0757	EPDM seal kit						
3430-0838	Viton seal kit						
3430-0943	EPDM Seal kit O rings and mech. seal only						

1543P-130SP, 1543P-130ESP, 1543P-390EHSP, 1543P-130ESP-01

U.S. UNITS

GPM at 0 PSI	GPM at 10 PSI	GPM at 20 PSI	GPM at 30 PSI	GPM at 40 PSI	GPM at 50 PSI	GPM at 58 PSI
440	400	338	269	184	68	0

1543P-130SP, 1543P-130ESP, 1543P-390EHSP, 1543P-130ESP-01

METRIC UNITS

LPM at 0 BAR	LPM at 0.7 BAR	LPM at 1.4 BAR	LPM at 2.1 BAR	LPM at 2.8 BAR	LPM at 3.4 BAR	LPM at 4.0 BAR
1666	1514	1279	1018	697	257	0

Viton® is a registered trademark of DuPont.
Hypro® is a registered trademark of Pentair.

Honda® is a registered trademark of Honda Motor Co., Ltd.
Briggs & Stratton® is a registered trademark of Briggs & Stratton Corporation.

POLYPROPYLENE, HYDRAULICALLY-DRIVEN, 2 IN & 3 IN.

Series 9342P and 9343P



FEATURES:

- ◆ Housing: 2"x2" or 3" X 3" Polypropylene
- ◆ Pump Seals: EPDM Mechanical
- ◆ Suction lift: 25 ft./7.62 m
- ◆ Poly impeller with stainless steel insert

ORDER INFORMATION 2" HYDRAULICALLY-DRIVEN

Model Number	Max GPM	Max LPM	Max PSI	Max BAR	Port Size	Motor Capacity
9342P-HM1C-5SP	200	757	58	40	2" x 2" NPT	10 gpm
9342PV-HM1C-5SP	200	757	58	40	2" x 2" NPT w. Viton	10 gpm
9342P-HM1C-5USP	206	780	60	41	2" x 2" FLANGE	11 gpm
9342P-HM5C-5SP	206	780	60	41	2" x 2" NPT	11 gpm
9342P-HM5C-5USP	206	780	60	41	2" x 2" FLANGE	11 gpm
9342PV-HM5C-5SP	206	780	60	41	2" x 2" NPT w. Viton	11 gpm
3430-0690	Pump head kit for HM1C with EPDM seal					
3430-0691	Pump head kit for HM5C with EPDM seal					
3430-0946	Pump Head kit with 2" FLANGES EPDM seals					
3430-0635	EPDM seal kit					
3430-0659	Viton seal kit					
3410-0041	Cam lock kit					

ORDER INFORMATION 3" HYDRAULICALLY-DRIVEN

Model Number	Max GPM	Max LPM	Max PSI	Max BAR	Port Size	Engine Mfg. & HP
9343P-GM6-SP	450	1703	52	3.6	3" x 3" NPT	Hydraulic
9343P-GM6Y-SP*	450	1703	52	3.6	3" x 3" NPT	Hydraulic
9343P-GM10-SP	484	1832	58	4.0	3" x 3" NPT	Hydraulic
9343P-GM10Y-SP*	484	1832	58	4.0	3" x 3" NPT	Hydraulic
9343P-GM6Y-SP-001	484	1832	58	4.0	3" x 3" FLANGE	Hydraulic
3430-0692	Pump head kit with EPDM seal					
3430-0692-02	Pump head kit with EPDM seal and 3" UF fittings					
3430-0757	EDPM seal kit					
3430-0838	Viton seal kit					
3410-0042	Cam lock kit					

* Y= case drain motor

9342P-HM1C-5SP

U.S. UNITS

Hyd. Flow GPM	GPM at 0 PSI	GPM at 10 PSI	GPM at 20 PSI	GPM at 30 PSI	GPM at 40 PSI	GPM at 50 PSI	GPM at 58 PSI
8	165	145	122	95	57		
9	185	166	144	119	86	0	
10	200	184	164	141	114	80	0

9342P-HM1C-5SP

METRIC UNITS

Hyd.Flow LPM	LPM at 0 BAR	LPM at 0.7 BAR	LPM at 1.4 BAR	LPM at 2.1 BAR	LPM at 2.8 BAR	LPM at 3.4 BAR	LPM at 4.0 BAR
30.3	625	549	463	358	215		
34.1	700	630	547	449	325	0	
37.9	757	695	620	534	433	301	0

9342P-HM5C-5SP

U.S. UNITS

Hyd. Flow GPM	GPM at 0 PSI	GPM at 10 PSI	GPM at 20 PSI	GPM at 30 PSI	GPM at 40 PSI	GPM at 50 PSI	GPM at 60 PSI
9	175	154	123	84	0		
10	192	174	149	118	76	0	
11	206	189	169	145	117	79	0

9342P-HM5C-5SP

METRIC UNITS

Hyd. Flow LPM	LPM at 0 BAR	LPM at 0.7 BAR	LPM at 1.4 BAR	LPM at 2.1 BAR	LPM at 2.8 BAR	LPM at 3.4 BAR	LPM at 4.1 BAR
34.1	662	582	467	316	0		
37.9	727	658	562	446	288	0	
41.6	780	717	639	550	442	299	0

9343P-GM6-SP

US UNITS

Performance	Feet PSI	0	12	23	35	46	58	69	81	92	104	116	127
8 gal/min	GPM	342	316	284	240	176	67	-	-	-	-	-	-
9 gal/min	GPM	378	355	327	294	252	194	103	-	-	-	-	-
10 gal/min	GPM	414	394	371	345	314	276	227	155	52	-	-	-
11 gal/min	GPM	450	433	414	392	368	340	307	265	210	128	28	-

9343P-GM6-SP

METRIC UNITS

Performance	m BAR	5.1	10.2	12.8	15.3	17.9	20.4	23.0	25.5	28.1	30.6	33.2	35.7
30 l/min	LPM	1110	885	730	495	145	165	-	-	-	-	-	-
35 l/min	LPM	1335	1180	1085	970	825	630	345	35	-	-	-	-
40 l/min	LPM	1545	1425	1355	1270	1185	1080	960	805	600	325	45	-

9343P-GM10-SP

US UNITS

Performance	Feet PSI	0	12	23	35	46	58	69	81	92	104	116	127
12 gal/min	GPM	364	340	310	274	227	157	46	-	-	-	-	-
13 gal/min	GPM	391	368	342	312	275	227	158	55	-	-	-	-
14 gal/min	GPM	415	395	373	348	318	282	236	170	74	-	-	-
15 gal/min	GPM	445	426	406	383	357	327	292	247	187	102	7	-
16 gal/min	GPM	484	466	446	425	401	374	344	309	266	211	139	47

9343P-GM10-SP

METRIC UNITS

Performance	m BAR	5.1	10.2	12.8	15.3	17.9	20.4	23.0	25.5	28.1	30.6	33.2	35.7
45 l/min	LPM	1225	1045	925	775	560	250	43	-	-	-	-	-
50 l/min	LPM	1390	1240	1150	1045	920	760	540	255	-24	-	-	-
55 l/min	LPM	1535	1405	1335	1255	1165	1060	935	780	575	310	35	-
60 l/min	LPM	1730	1610	1540	1470	1390	1305	1215	1105	985	840	665	445

POLYPROPYLENE, PEDESTAL MOUNT, 3 IN.

Series 9243P



FEATURES:

- ◆ Housing: 3" X 3" Polypropylene
- ◆ Pump Seals: EPDM Mechanical
- ◆ Suction lift: 25 ft./7.62 m
- ◆ Poly impeller with stainless steel insert
- ◆ 1" keyed shaft

ORDER INFORMATION

Model Number	Max GPM	Max LPM	Max PSI	Max BAR	Port Size
9243P-SP	460	1741	54	3.7	3"x 3" NPT
3430-0692	Pump head kit with EPDM seal				
3430-0692-02	Pump head kit with EPDM seal and 3" UF Fittings				
3430-0757	EPDM seal kit				
3430-0838	Viton seal kit				
3410-0042	Cam lock kit				

9243P-SP

U.S. UNITS

	Feet	0	12	23	35	46	58	69	81	92	104	116
	PSI	0	5	10	15	20	25	30	35	40	45	50
2900 RPM	GPM	380	358	342	312	275	224	160	50	-	-	-
	HP	7.1	6.8	6.5	6.3	6.0	5.6	5.0	4.2	-	-	-
3200 RPM	GPM	424	405	384	359	331	297	251	193	103	0	-
	HP	9.1	8.9	8.7	8.5	8.3	8.0	7.5	7.0	6.2	5.3	-
3500 RPM	GPM	460	445	425	404	379	353	321	280	227	159	70
	HP	12.2	11.8	11.4	11.1	10.9	10.6	10.2	9.8	9.2	8.5	7.5

9243P-SP

METRIC UNITS

	m	5.1	10.2	12.8	15.3	17.9	20.4	23.0	25.5	28.1	30.6	33.2	35.7
	BAR	0.50	1.00	1.25	1.50	1.75	2.00	2.25	2.50	2.75	3.00	3.25	3.50
2900 RPM	LPM	1325	1193	1097	980	830	637	376	46	-	-	-	-
	kW	5.0	4.7	4.6	4.4	4.1	3.8	3.4	2.9	-	-	-	-
3200 RPM	LPM	1497	1378	1301	1215	1118	996	853	660	403	154	-	-
	kW	6.6	6.4	6.3	6.1	6.0	5.7	5.5	5.2	4.7	4.3	-	-
3500 RPM	LPM	1650	1537	1471	1403	1328	1242	1139	1016	866	685	467	208
	kW	8.7	8.3	8.2	8.0	7.9	7.7	7.5	7.2	6.9	6.5	6.0	5.5

POLYPROPYLENE, ELECTRIC-DRIVEN, 2 IN.

Series 9742P



FEATURES:

- ◆ Available with either 5 hp or 7.5 hp 50/60 hz TEFC Baldor electric motor
 - Three phase 230/460 volt motors in both 5 hp & 7.5 hp
 - Single phase 230 volt motor available in 5 hp
- ◆ Housing: 2" x 2" Polypropylene
- ◆ Pump Seals: EPDM Mechanical
- ◆ Suction Lift: 25ft/7.62m
- ◆ Nylon impeller

ORDER INFORMATION 50 HZ

Model Number	Max GPM	Max LPM	Max PSI	Max BAR	Port Size	Engine Mfg. & HP	Mounting Bolts
9742P-050SPT	120	454	32	2.2	2"x 2" NPT	Polypropylene	5/16" or M8
9742P-050SPT3	120	454	32	2.2	2"x 2" NPT	Polypropylene	5/16" or M8
9742P-075SPT3	160	606	37	2.6	2"x 2" NPT	Polypropylene	5/16" or M8

ORDER INFORMATION 60 HZ

Model Number	Max GPM	Max LPM	Max PSI	Max BAR	Port Size	Engine Mfg. & HP	Mounting Bolts
9742P-050SPT	150	568	47	3.2	2"x 2" NPT	Polypropylene	5/16" or M8
9742P-050SPT3	150	568	47	3.2	2"x 2" NPT	Polypropylene	5/16" or M8
9742P-075SPT3	188	712	54	3.7	2"x 2" NPT	Polypropylene	5/16" or M8

9742P-050SPT & 9742P-050SPT3

US UNITS

60 Hz	PSI	0	5	10	15	20	25	30	35	40	45	47
	GPM	150	142	133	123	111	97	84	66	43	9	0
50 Hz	PSI	0	5	10	15	20	25	30	32	-	-	-
	GPM	120	110	100	85	67	42	10	0	-	-	-

9742P-050SPT & 9742P-050SPT3

METRIC UNITS

60 Hz	BAR	0	0.3	0.7	1	1.4	1.7	2.1	2.4	2.8	3.1	3.2
	LPM	568	538	503	466	420	367	318	250	163	34	0
50 Hz	BAR	0	0.3	0.7	1	1.4	1.7	2.1	2.2	-	-	-
	LPM	454	416	379	322	254	159	38	0	-	-	-

9742P-075SPT3

US UNITS

60 Hz	PSI	0	5	10	15	20	25	30	35	40	45	50	54
	GPM	188	185	181	173	163	151	136	120	102	76	44	0
50 Hz	PSI	0	5	10	15	20	25	30	35	37	-	-	-
	GPM	160	155	143	129	112	90	65	20	0	-	-	-

9742P-075SPT3

METRIC UNITS

60 Hz	BAR	0	0.3	0.7	1	1.4	1.7	2.1	2.4	2.8	3.1	3.4	3.7
	LPM	712	700	685	655	617	572	515	454	386	288	167	0
50 Hz	BAR	0	0.3	0.7	1	1.4	1.7	2.1	2.4	2.6	-	-	-
	LPM	606	587	541	488	424	341	246	76	0	-	-	-

CAST IRON GAS, ENGINE-DRIVEN, 2 IN. & 3 IN.

Series 1530



1532C-6SP
with PowerPro Engine

FEATURES:

- ◆ Gas engine driven (EPA & CARB certified)
- ◆ Pump seals: fluoroelastomer (viton)
- ◆ Suction lift: 20 ft. (6 m)
- ◆ Flapper valve: EPDM
- ◆ Comes standard with silicon carbide mechanical seals, use optional carbon ceramic if pumping liquid fertilizer

ORDER INFORMATION

Model Number	Max GPM	Max LPM	Max PSI	Max BAR	Port Size	Engine Mfrg. & HP
1532C-6SP	170	644	42	2.9	2" x 2" NPT	PowerPro 6.5 hp
1532C-160HSP	170	644	42	2.9	2" x 2" NPT	Honda GX160
1533C-13SP	330	1249	60	4.1	3" x 3" NPT	PowerPro 13 hp
1533C-13ESP	330	1249	60	4.1	3" x 3" NPT	PowerPro 13 hp w/ electric start
1533C-390EHSP	330	1249	60	4.1	3" x 3" NPT	Honda GX390 w/ electric start
3430-0673CSP	170	644	42	2.9		Pump head kit for 2" NPT self-priming cast iron transfer pump
3430-0674CSP	330	1249	60	4.1		Pump head kit for 3" NPT self-priming cast iron transfer pump
3430-0863						2" Viton seal kit
2120-0070						2" carbon ceramic mechanical seal
2120-0071						3" carbon ceramic mechanical seal

1532C-6SP, 1532C-160HSP

U.S. UNITS

1532C-6SP, 1532-160HSP

METRIC UNITS

GPM at 0 PSI	GPM at 5 PSI	GPM at 10 PSI	GPM at 15 PSI	GPM at 20 PSI	GPM at 25 PSI	GPM at 30 PSI	GPM at 35 PSI	GPM at 40 PSI	GPM at 42 PSI	LPM at 0.0 BAR	LPM at 0.3 BAR	LPM at 0.7 BAR	LPM at 1.0 BAR	LPM at 1.4 BAR	LPM at 1.7 BAR	LPM at 2.1 BAR	LPM at 2.4 BAR	LPM at 2.8 BAR	LPM at 2.9 BAR
170	155	140	123	106	87	65	42	14	0	644	587	530	466	401	329	246	159	53	0

1533C-13SP, 1533C-13ESP, 1533C-390EHSP

U.S. UNITS

GPM at 0 PSI	GPM at 5 PSI	GPM at 10 PSI	GPM at 15 PSI	GPM at 20 PSI	GPM at 25 PSI	GPM at 30 PSI	GPM at 35 PSI	GPM at 40 PSI	GPM at 45 PSI	GPM at 50 PSI	GPM at 60 PSI	GPM at 66 PSI
330	325	321	315	296	273	248	221	192	161	129	48	0

1533C-13SP, 1533C-13ESP, 1533C-390EHSP

METRIC UNITS

LPM at 0.0 BAR	LPM at 0.3 BAR	LPM at 0.7 BAR	LPM at 1.0 BAR	LPM at 1.4 BAR	LPM at 1.7 BAR	LPM at 2.1 BAR	LPM at 2.4 BAR	LPM at 2.8 BAR	LPM at 3.1 BAR	LPM at 3.4 BAR	LPM at 4.1 BAR	LPM at 4.6 BAR
1249	1230	1215	1192	1120	1033	938	836	726	609	488	181	0

CAST IRON, PEDESAL-MOUNT, 2 IN. & 3 IN.



3430-0674CSP



9232C-SP

ORDER INFORMATION

Model Number	Max GPM	Max LPM	Max PSI	Max BAR	Description
9232C-SP	170	644	42	2.9	2" x 2" NPT self priming pedestal-mount cast iron transfer pump (3/4" keyed shaft)
9233C-SP	330	1249	60	4.1	3" x 3" NPT self priming pedestal-mount cast iron transfer pump (1" keyed shaft)
3430-0673CSP	170	644	42	2.9	Pump head kit for 2" NPT self-priming cast iron transfer pump
3430-0674CSP	330	1249	60	4.1	Pump head kit for 3" NPT self-priming cast iron transfer pump
3430-0675					Replacement pedestal for 2" NPT self-priming cast iron transfer pump
3430-0676					Replacement pedestal for 3" NPT self-priming cast iron transfer pump

9232C-SP, 3430-0673CSP

U.S. UNITS

GPM at 0 PSI	GPM at 5 PSI	GPM at 10 PSI	GPM at 15 PSI	GPM at 20 PSI	GPM at 25 PSI	GPM at 30 PSI	GPM at 35 PSI	GPM at 40 PSI	GPM at 42 PSI
170	155	140	123	106	87	65	42	14	0

9232C-SP, 3430-0673CSP

METRIC UNITS

LPM at 0.0 BAR	LPM at 0.3 BAR	LPM at 0.7 BAR	LPM at 1.0 BAR	LPM at 1.4 BAR	LPM at 1.7 BAR	LPM at 2.1 BAR	LPM at 2.4 BAR	LPM at 2.8 BAR	LPM at 2.9 BAR
644	587	530	466	401	329	246	159	53	0

9233C-SP, 3430-0674CSP

U.S. UNITS

GPM at 0 PSI	GPM at 5 PSI	GPM at 10 PSI	GPM at 15 PSI	GPM at 20 PSI	GPM at 25 PSI	GPM at 30 PSI	GPM at 35 PSI	GPM at 40 PSI	GPM at 45 PSI	GPM at 50 PSI	GPM at 60 PSI	GPM at 66 PSI
330	325	321	315	296	273	248	221	192	161	129	48	0

9233C-SP, 3430-0674CSP

METRIC UNITS

LPM at 0.0 BAR	LPM at 0.3 BAR	LPM at 0.7 BAR	LPM at 1.0 BAR	LPM at 1.4 BAR	LPM at 1.7 BAR	LPM at 2.1 BAR	LPM at 2.4 BAR	LPM at 2.8 BAR	LPM at 3.1 BAR	LPM at 3.4 BAR	LPM at 4.1 BAR	LPM at 4.6 BAR
1249	1230	1215	1192	1120	1033	938	836	726	609	488	181	0

ALUMINUM GAS ENGINE-DRIVEN, 2 IN. & 3 IN.

Series 1540A



1541A-SP



1543A-65TSP



1543A-65SP

FEATURES:

- ◆ PowerPro Gas engine driven (EPA & CARB certified)
- ◆ Housing: Aluminum
- ◆ Pump seals: EPDM Mechanical
- ◆ Suction lift: 13 ft./4m (1541A) & 23 ft./7.01m (1542A & 1543A)
- ◆ Trash pumps will handle 1-1/8" (29 mm) solids
- ◆ Transfer pumps will handle 3/8" (9.5mm) solids
- ◆ Framed: 1542A & 1543A versions only

ORDER INFORMATION

Model Number	Max GPM	Max LPM	Max PSI	Max BAR	Port Size	Engine Mfr. & HP
1541A-SP	40	151	28	1.9	2" x 2" BSP	PowerPro 2.5 hp
1542A-65SP	147	556	50	3.4	2" x 2" NPT	PowerPro 6.5 hp
1542A-160HSP	147	556	50	3.4	2" x 2" NPT	Honda GX160
1543A-65SP	259	980	50	3.4	3" x 3" NPT	PowerPro 6.5 hp
1543A-160HSP	259	980	50	3.4	3" x 3" NPT	Honda GX160
1543A-65TSP (Trash)	272	1030	50	3.4	3" x 3" NPT	PowerPro 6.5 hp
1543A-160HTSP	272	1030	50	3.4	3" x 3" NPT	Honda GX160
3430-0791	3" Trash Kit (NPT ports, SAE 3/4" keyed shaft mount)					
3430-0792	2" Transfer Kit (NPT ports, SAE 3/4" keyed shaft mount)					
3430-0793	3" Transfer Kit (NPT ports, SAE 3/4" keyed shaft mount)					
3430-0802	Seal kit for 2" Transfer pump					

1541A-SP

U.S. UNITS					
GPM at 0 PSI	GPM at 10 PSI	GPM at 15 PSI	GPM at 20 PSI	GPM at 25 PSI	GPM at 28 PSI
40	28	21	14	7	0

1541A-SP

METRIC UNITS					
LPM at 0 BAR	LPM at 0.7 BAR	LPM at 1.0 BAR	LPM at 1.4 BAR	LPM at 1.7 BAR	LPM at 1.9 BAR
151.4	106.0	79.5	53.0	26.5	0

1542A-65SP, 1542A-160HSP

U.S. UNITS										
GPM at 5 PSI	GPM at 10 PSI	GPM at 15 PSI	GPM at 20 PSI	GPM at 25 PSI	GPM at 30 PSI	GPM at 35 PSI	GPM at 40 PSI	GPM at 45 PSI	GPM at 50 PSI	GPM at 55 PSI
147	144	136.6	124.7	110.2	94.1	78.3	57.1	19.2	0	0

1542A-65SP, 1542A-160HSP

METRIC UNITS										
LPM at 0.3 BAR	LPM at 0.7 BAR	LPM at 1.0 BAR	LPM at 1.4 BAR	LPM at 1.7 BAR	LPM at 2.1 BAR	LPM at 2.4 BAR	LPM at 2.8 BAR	LPM at 3.1 BAR	LPM at 3.4 BAR	LPM at 3.7 BAR
556.5	545.1	517.1	472	417.2	356.2	296.4	216.1	72.7	0	0

1543A-65SP, 1543A-160HSP

U.S. UNITS										
GPM at 5 PSI	GPM at 10 PSI	GPM at 15 PSI	GPM at 20 PSI	GPM at 25 PSI	GPM at 30 PSI	GPM at 35 PSI	GPM at 40 PSI	GPM at 45 PSI	GPM at 50 PSI	GPM at 55 PSI
259	251.6	233.7	213.6	190.9	162.2	135.8	99.3	56.1	8.7	0

1543A-65SP, 1543A-160HSP

METRIC UNITS										
LPM at 0.3 BAR	LPM at 0.7 BAR	LPM at 1.0 BAR	LPM at 1.4 BAR	LPM at 1.7 BAR	LPM at 2.1 BAR	LPM at 2.4 BAR	LPM at 2.8 BAR	LPM at 3.1 BAR	LPM at 3.4 BAR	LPM at 3.7 BAR
980.4	952.4	884.6	808.6	722.6	614	514.1	375.9	212.4	32.9	0

1543A-65TSP, 1543A-160HTSP

U.S. UNITS										
GPM at 5 PSI	GPM at 10 PSI	GPM at 15 PSI	GPM at 20 PSI	GPM at 25 PSI	GPM at 30 PSI	GPM at 35 PSI	GPM at 40 PSI	GPM at 45 PSI	GPM at 50 PSI	GPM at 55 PSI
272	269.8	241	207.6	179.3	140.4	98.1	50.7	5.4	0	0

1543A-65TSP, 1543A-160HTSP

METRIC UNITS										
LPM at 0.3 BAR	LPM at 0.7 BAR	LPM at 1.0 BAR	LPM at 1.4 BAR	LPM at 1.7 BAR	LPM at 2.1 BAR	LPM at 2.4 BAR	LPM at 2.8 BAR	LPM at 3.1 BAR	LPM at 3.4 BAR	LPM at 3.7 BAR
1029.6	1021.3	912.3	785.8	678.7	531.5	371.3	191.9	20.4	0	0

Honda® is a registered trademark of Honda Motor Co., Ltd.

Briggs & Stratton® is a registered trademark of Briggs & Stratton Corporation. Hypro® is a registered trademark of Pentair Ltd.

ALUMINUM, GAS ENGINE-DRIVEN, 2 IN. & 3 IN.

Series 1570



FEATURES:

- ◆ Honda® engine (EPA & CARB certified)
- ◆ Close-coupled, gas engine driven
- ◆ Housing: Aluminum
- ◆ Pump seals: Buna-N/ceramic
- ◆ Inlet valve: Buna-N
- ◆ Suction lift: 28 ft./8.53m

ORDER INFORMATION

Model Number	Max GPM	Max LPM	Max PSI	Max BAR	Port Size	Engine Mfgr. & HP
1572-SPX	145	549	50	3.4	2" x 2" NPT	Honda® 4 hp
1573-SPX	280	1060	50	3.4	3" x 3" NPT	Honda® 5.5 hp

1572-SPX

U.S. UNITS

GPM at 0 PSI	GPM at 5 PSI	GPM at 10 PSI	GPM at 15 PSI	GPM at 20 PSI	GPM at 25 PSI	GPM at 30 PSI	GPM at 35 PSI	GPM at 40 PSI	GPM at 45 PSI	GPM at 50 PSI
145	141	133	125	114	102	87	70	51	24	0

1572-SPX

METRIC UNITS

LPM at 0.0 BAR	LPM at 0.3 BAR	LPM at 0.7 BAR	LPM at 1.0 BAR	LPM at 1.4 BAR	LPM at 1.7 BAR	LPM at 2.1 BAR	LPM at 2.4 BAR	LPM at 2.8 BAR	LPM at 3.1 BAR	LPM at 3.4 BAR
549	534	503	473	432	386	329	265	193	91	

1573-SPX

U.S. UNITS

GPM at 0 PSI	GPM at 5 PSI	GPM at 10 PSI	GPM at 15 PSI	GPM at 20 PSI	GPM at 25 PSI	GPM at 30 PSI	GPM at 35 PSI	GPM at 40 PSI	GPM at 45 PSI	GPM at 50 PSI
280	268	255	233	211	181	149	115	77	46	0

1573-SPX

METRIC UNITS

LPM at 0.0 BAR	LPM at 0.3 BAR	LPM at 0.7 BAR	LPM at 1.0 BAR	LPM at 1.4 BAR	LPM at 1.7 BAR	LPM at 2.1 BAR	LPM at 2.4 BAR	LPM at 2.8 BAR	LPM at 3.1 BAR	LPM at 3.4 BAR
1060	1014	965	882	799	685	564	435	291	174	

TRANSFER PUMPS ACCESSORIES

Transfer Pump Cam Lock Kit



FEATURES:

- ◆ Hypro cam lock kits easily add heavy-duty male cam lock connections to the NPT ports of 2" and 3" polypropylene pumps.
- ◆ Includes one male cam lock adapter for pump inlet
- ◆ Includes one heavy-duty 90° elbow and one male cam lock adapter for the pump outlet
- ◆ Prepares transfer pumps for the most common means of quick coupling a hose
- ◆ Interchangeable with other cam lock fittings made to MIL-C-27487 specifications

ORDER INFORMATION

Size	Model Number
2" NPT	3410-0041
3" NPT	3410-0042

Honda® is a registered trademark of Honda Motor Co., Ltd.
Hypro® is a registered trademark of Pentair.

ROLLER PUMP COMPARISONS

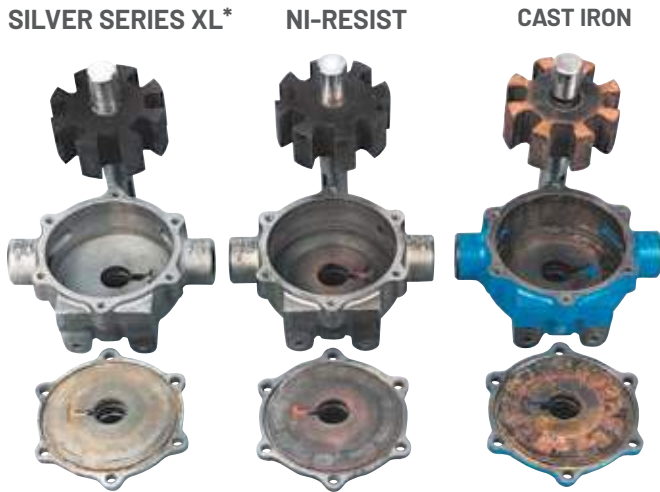

These three pump housings were photographed after being tested with a 30:1 mix of water and Roundup® herbicide.

The Ni-Resist and Cast Iron indicate damage from pitting and corrosion, but the Silver Series XL is in like-new condition after more than 1000 hours of use.

*Get up to 10 times longer pump life with Hypro Silver Series XL Roller pumps!

HERBICIDE USERS: GET UP TO 10 TIMES LONGER PUMP LIFE!

- ◆ Cast Iron pumps lasted to 140 hours before failure.
- ◆ Ni-Resist pumps lasted to 332 hours before failure.
- ◆ Silver Series X pumps ran over 1000 hours and still met new pump specs!

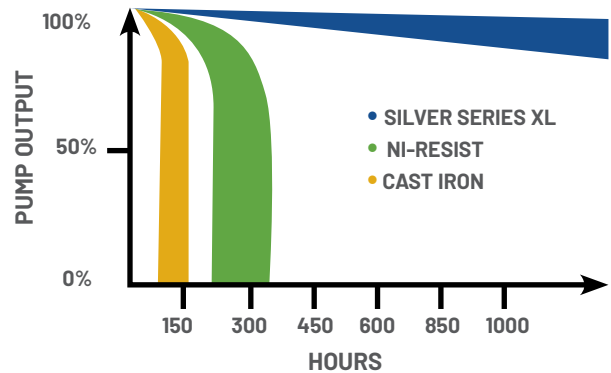

Floating Design, PTFE Coating



Ni-Resist Pumps

FLOATING PTFE COATED ROTORS

- ◆ Floating rotor design and black PTFE coating on metal rotors increases performance and extends pump life
- ◆ Standard production in 4001, 4101, 6500, & 7560 Silver Series XL and Ni-Resist pumps

CLEAR COAT FINISH

- ◆ Offers increased protection from chemical attack and from the elements
- ◆ Included on all Ni-Resist roller pumps

Roundup® is a registered trademark of Monsanto Co.

PUMP RECOMMENDATIONS FOR APPLICATIONS

WHICH ROLLER PUMP, ROLLERS AND SEALS SHOULD YOU USE?

Material options for rollers and seals are listed in the order of recommendations for usage.

These recommendations are only a general guide. For suggestions on specific chemicals or applications, call Pentair's Technical/Applications Department at (800) 445-8360.

Application	Specific Chemicals	Suggestions							
		Housing Materials			Roller Materials			Seal Materials	
		Silver Series XL	Ni-Resist	Cast Iron	Super Roller	Poly Rollers	Teflon® Rollers*	Viton®	Buna-N
WEED CONTROL CHEMICALS	Emulsions, soluble powders, sodium arsenate.	X	X	X	X			X	
	Chemicals containing glyphosate (such as Roundup®) or other acidics	X			X	X	X*	X	
INSECT CONTROL	Emulsions not containing aromatic solvents.	X	X	X	X			X	
BRUSH CONTROL	Heavy-duty sprays using diesel oil for carrier.	X	X	X	X			X	
PEST CONTROL CHEMICALS, FUMIGANTS, ETC.	This category or use includes mosquito sprays, termite control liquids, nematocides, soil and grain fumigants where any of the following chemicals with aromatic solvents are present: Pentachlorophenol, xylene, xylol, benzene, high sulphur fuel or diesel oil. Fumigants containing: ethylene dichloride, ethylene dibromide, carbon tetrachloride, perchlorethylene, trichlorethylene, methyl bromide, and other aromatic solvents.	X	X	X	X			X	
LIQUID FERTILIZERS	Up to 32% nitrogen content, or others if the liquid is atmospheric pressure and the temperature is handled.	X	X			X			X
POWDERED FERTILIZERS	Fertilizers dissolved in water (greenhouse plant food).	X	X	X	X	X		X	X
PUMPING	Large quantities of plain water.	X	X	X	X	X		X	X
SPRAYING	Wettable powder sprays.	X	X	X	X	X		X	X
MATERIAL HANDLING	Heavy abrasive powders in suspension.	X	X	X	X	X		X	X
ACIDS	Mild sulfuric acid for spraying. Mild muriatic acid, inhibited muriatic, etc.	X				X	X*	X	

*Note: Limit Pressure at 100 psi (6.9 bar) when using Teflon® Rollers.

CAST IRON, NI-RESIST OR SILVER SERIES XL

Series 4001 4 Roller



Pressure in PSI and BAR	GPM	HP	GPM	HP	GPM	HP
	LPM	HP	LPM	HP	LPM	HP
	@1100 RPM		@1400 RPM		@1800 RPM	
0 PSI	5.5	.06	7.1	.10	9.1	.14
0 BAR	20.8	.06	26.9	.10	34.4	.14
25 PSI	4.9	.14	6.4	.20	8.5	.30
1.7 BAR	18.5	.14	24.2	.20	32.2	.30
50 PSI	4.4	.24	5.9	.32	8.0	.46
3.4 BAR	16.6	.24	22.3	.32	30.3	.46
75 PSI	4.1	.34	5.6	.44	7.6	.62
5.2 BAR	15.5	.34	21.2	.44	28.7	.62
100 PSI	3.8	.41	5.3	.56	7.3	.78
6.9 BAR	14.4	.41	20.1	.56	27.6	.78
125 PSI	3.5	.50	5.0	.68	7.0	.95
8.6 BAR	13.2	.50	18.9	.68	26.5	.95
150 PSI	3.3	.62	4.8	.78	6.7	1.1
10.3 BAR	12.5	.62	18.2	.78	25.4	1.1

FEATURES:

- ◆ Port size: 3/4" NPT
- ◆ Max. fluid temperature: 140°F/60°C
- ◆ Housing: Cast Iron (C), Ni-Resist (N) or Silvercast (XL)
- ◆ Pump shaft rotation: Clockwise when looking at the shaft end (counter clockwise available)
- ◆ Rollers: Super Rollers standard [Poly (T3) and Teflon® (T2)]
- ◆ Shaft Seals: Viton® standard
- ◆ Available shaft adapters: See page 76
- ◆ Special torque arm and base kit is available for gas engines
- ◆ Rotor: Cast Iron, Ni-Resist or Silvercast
- ◆ Weight: 5 lbs./2.3 kg

ORDER INFORMATION

Model Number	Max GPM	Max LPM	Max PSI	Max BAR	Max RPM	Shaft Output		
						U.S.	Metric	Shaft
4001C	9.1	34.4	150	10.3	1800	5/8"	15.9 mm	solid
4001C-H	9.1	34.4	150	10.3	1800	1/2"	12.7 mm	hollow
4001	9.1	34.4	150	10.3	1800	5/8"	15.9 mm	solid
4001N-H	9.1	34.4	150	10.3	1800	1/2"	12.7 mm	hollow
4001XL	9.1	34.4	150	10.3	1800	5/8"	15.9 mm	solid
4001XL-H	9.1	34.4	150	10.3	1800	1/2"	12.7 mm	hollow

Teflon® rollers - Add Suffix "T2" - (i.e.: 4001C-T2).
 Polypropylene rollers - Add Suffix "T3" - (i.e.: 4001C-T3).
 Reverse rotation* - Add Suffix "R" - (i.e.: 4001C-R).

CAST IRON, NI-RESIST OR SILVER SERIES XL

Series 4101 4 Roller



Pressure in PSI and BAR	GPM	HP	GPM	HP	GPM	HP
	LPM	HP	LPM	HP	LPM	HP
	@1800 RPM		@2200 RPM		@2600 RPM	
0 PSI	5.0	.11	6.2	.14	7.2	.16
0 BAR	18.9	.11	23.5	.14	27.3	.16
25 PSI	4.8	.21	5.8	.27	6.9	.30
1.7 BAR	18.1	.21	21.9	.27	26.1	.30
50 PSI	4.5	.34	5.6	.40	6.6	.46
3.4 BAR	17.0	.34	21.2	.40	25.0	.46
75 PSI	4.2	.45	5.4	.55	6.4	.62
5.2 BAR	15.9	.45	20.4	.55	24.2	.62
100 PSI	3.9	.56	5.0	.68	6.0	.76
6.9 BAR	14.8	.56	18.9	.68	22.7	.76
125 PSI	3.7	.68	4.7	.82	5.7	.92
8.6 BAR	14.0	.68	17.8	.82	21.6	.92
150 PSI	3.4	.78	4.4	.96	5.4	1.08
10.3 BAR	12.9	.78	16.6	.96	20.4	1.08

FEATURES:

- ◆ Port size: 3/4" NPT
- ◆ Max. fluid temperature: 140°F/60°C
- ◆ Housing: Cast Iron (C), Ni-Resist (N) or Silvercast (XL)
- ◆ Pump shaft rotation: Clockwise when looking at the shaft end (counter clockwise available)
- ◆ Rollers: Super Rollers standard [Poly (T3) and Teflon® (T2)]
- ◆ Shaft Seals: Viton® standard
- ◆ Available shaft adapters: See page 76
- ◆ Special torque arm and base kit is available for gas engines
- ◆ Rotor: Cast Iron, Ni-Resist or Silvercast
- ◆ Weight: 5 lbs./2.27 kg

ORDER INFORMATION

Model Number	Max GPM	Max LPM	Max PSI	Max BAR	Max RPM	Shaft Output		
						U.S.	Metric	Shaft
4101C	7.2	27.3	150	10.3	2600	5/8"	15.9 mm	solid
4101C-H	7.2	27.3	150	10.3	2600	1/2"	12.7 mm	hollow
4101N	7.2	27.3	150	10.3	2600	5/8"	15.9 mm	solid
4101N-H	7.2	27.3	150	10.3	2600	1/2"	12.7 mm	hollow
4101XL	7.2	27.3	150	10.3	2600	5/8"	15.9 mm	solid
4101XL-H	7.2	27.3	150	10.3	2600	1/2"	12.7 mm	hollow

Teflon® rollers - Add Suffix "T2" - (i.e.: 4101C-T2).
 Polypropylene rollers - Add Suffix "T3" - (i.e.: 4101C-T3).
 Reverse rotation* - Add Suffix "R" - (i.e.: 4101C-R).

Teflon® is a registered trademark of E. I. DuPont de Nemours and Co.
 Viton® is a registered trademark of DuPont. Hypro® is a registered trademark of Pentair.

NI-RESIST OR SILVER SERIES XL

Series 4001 and 4101 12 volt DC 4 Roller



FEATURES:

- ◆ Super Rollers and Viton® seals standard
- ◆ Locking collar and torque arm come in each package
- ◆ Rotor: Ni-Resist (N) or Silvercast (XL)
- ◆ Weight: 16-18 lbs./7.3-8.2 kg

Note: All models come in either Ni-Resist or Silver Series XL housings.

ORDER INFORMATION

Model Number	Max GPM	Max LPM	Max PSI	Max BAR	Max RPM	U.S	Shaft Output Metric	Shaft
4001N-EH	10.4	39.4	30	2.1	1900	1/2"	12.7 mm	hollow
4001N-E2H	9.9	37.5	50	3.4	1600	1/2"	12.7 mm	hollow
4001XL-EH	10.4	39.4	30	2.1	1900	1/2"	12.7 mm	hollow
4001XL-E2H	9.9	37.5	50	3.4	1600	1/2"	12.7 mm	hollow
4101N-EH	7.5	28.4	50	3.4	1900	1/2"	12.7 mm	hollow
4101N-E2H	5.9	22.3	90	6.2	1600	1/2"	12.7 mm	hollow
4101XL-EH	7.5	28.4	50	3.4	1900	1/2"	12.7 mm	hollow
4101XL-E2H	5.9	22.3	90	6.2	1600	1/2"	12.7 mm	hollow

Teflon® rollers - Add Suffix "T2" - (i.e.: 4001N-EHT2).

Polypropylene rollers - Add Suffix "T3" - (i.e.: 4001N-EHT3).

U.S. UNITS

Series 4101-EH and 4101-E2H	Model 4101N-EH & 4101XL-EH			Model 4101N-E2H & 4101XL-E2H			
	Volts	PSI	AMPS	GPM	PSI	AMPS	GPM
	12.0 (Battery) Engine Off	0	10.0	6.3	0	---	---
5		11.3	6.0	10	8.4	5.3	
10		12.5	5.8	20	11.8	4.8	
15		13.7	5.6	30	13.7	4.65	
20		15.1	5.4	40	16.4	4.4	
25		16.7	5.2	50	19.6	4.05	
30		18.6	5.0	60	22.8	3.65	
35		20.3	4.8	70	25.8	3.20	
40		22.3	4.6	80	28.9	3.00	
45		24.1	4.4	90	31.5	2.75	
13.5 (Alternator) Engine Running	0	10.4	7.5	0	---	---	
	5	11.7	7.0	10	9.1	5.9	
	10	13.0	6.6	20	11.2	5.6	
	15	14.2	6.4	30	13.9	5.25	
	20	15.8	6.2	40	16.9	5.0	
	25	17.4	6.0	50	19.5	4.7	
	30	19.6	5.8	60	22.7	4.35	
	35	20.9	5.6	70	25.7	4.0	
	40	22.5	5.4	80	29.2	3.6	
	45	24.3	5.2	90	31.9	3.4	
50	26.1	5.0	100	34.8	3.2		

Series 4001-EH and 4001-E2H	Model 4001N-EH & 4001XL-EH			Model 4001N-E2H & 4001XL-E2H			
	Volts	PSI	AMPS	GPM	PSI	AMPS	GPM
	12.0 (Battery) Engine Off	0	12.6	9.0	10	13.9	8.4
5		14.1	8.3	20	18.0	7.9	
10		15.2	8.1	30	22.2	7.2	
15		17.3	7.8	35	25.0	6.9	
20		19.7	7.2	40	27.0	6.5	
25		22.1	6.7	50	31.6	5.9	
30		24.8	6.2	60	36.2	5.4	
13.5 (Alternator) Engine Running	0	13.4	10.4	10	14.4	9.9	
	5	14.8	9.9	20	18.3	9.1	
	10	16.2	9.4	30	22.3	8.5	
	15	18.2	8.9	35	24.5	8.3	
	20	20.5	8.5	40	27.0	8.0	
	25	22.5	8.2	50	31.0	7.3	
30	24.9	7.7	60	36.1	6.8		

Teflon® is a registered trademark of E.I. DuPont de Nemours and Co.

Viton® is a registered trademark of DuPont. Hypro® is a registered trademark of Pentair.

METRIC UNITS

Series 4101-EH and 4101-E2H	Model 4101N-EH & 4101XL-EH			Model 4101N-E2H & 4101XL-E2H			
	Volts	BAR	AMPS	LPM	BAR	AMPS	LPM
	12.0 (Battery) Engine Off	0	10.0	23.8	0	---	---
.3		11.3	22.7	.7	8.4	20.0	
.7		12.5	22.0	1.4	11.8	18.2	
1.0		13.7	21.2	2.1	13.7	17.6	
1.4		15.1	20.4	2.8	16.4	16.7	
1.7		16.7	19.7	3.4	19.6	15.3	
2.1		18.6	18.9	4.1	22.8	13.8	
2.4		20.3	18.2	4.8	25.8	12.1	
2.8		22.3	17.4	5.5	28.9	11.4	
3.1		24.1	16.7	6.2	31.5	10.4	
13.5 (Alternator) Engine Running	0	10.4	28.4	0	---	---	
	.3	11.7	26.5	.7	9.1	22.3	
	.7	13.0	25.0	1.4	11.2	21.2	
	1.0	14.2	24.2	2.1	13.9	19.9	
	1.4	15.8	23.5	2.8	16.9	18.9	
	1.7	17.4	22.7	3.4	19.5	17.8	
	2.1	19.6	22.0	4.1	22.7	16.5	
	2.4	20.9	21.2	4.8	25.7	15.1	
	2.8	22.5	20.4	5.5	29.2	13.6	
	3.1	24.3	19.7	6.2	31.9	12.9	
3.4	26.1	18.9	6.9	34.8	12.1		

Series 4001-EH and 4001-E2H	Model 4001N-EH & 4001XL-EH			Model 4001N-E2H & 4001XL-E2H			
	Volts	BAR	AMPS	LPM	BAR	AMPS	LPM
	12.0 (Battery) Engine Off	0	12.6	34.1	.7	13.9	31.8
.3		14.1	31.4	1.4	18.0	29.9	
.7		15.2	30.7	2.1	22.2	27.3	
1.0		17.3	29.5	2.4	25.0	26.1	
1.4		19.7	27.3	2.8	27.0	24.6	
1.7		22.1	25.4	3.5	31.6	22.3	
2.1		24.8	23.5	4.1	36.2	20.4	
13.5 (Alternator) Engine Running	0	13.4	39.4	.7	14.4	37.5	
	.3	14.8	37.5	1.4	18.3	34.4	
	.7	16.2	35.6	2.1	22.3	32.2	
	1.0	18.2	33.7	2.4	24.5	31.4	
	1.4	20.5	32.2	2.8	27.0	30.3	
	1.7	22.5	31.0	3.5	31.0	27.6	
2.1	24.9	29.1	4.1	36.1	25.7		

CAST IRON, NI-RESIST OR SILVER SERIES XL

Series 6500 6-Roller



Pressure in PSI and BAR	GPM	HP	GPM	HP	GPM	HP
	LPM	HP	LPM	HP	LPM	HP
	@540 RPM		@1000 RPM		@1200 RPM	
0 PSI	9.7	.08	18.2	.20	21.8	.30
0 BAR	36.7	.08	68.9	.20	82.5	.30
50 PSI	8.0	.38	16.5	.71	20.1	.90
3.4 BAR	30.3	.38	62.4	.71	76.1	.90
100 PSI	7.2	.68	15.4	1.26	19.1	1.51
6.9 BAR	27.3	.68	58.3	1.26	72.3	1.51
150 PSI	6.6	.97	14.7	1.80	18.2	2.14
10.3 BAR	25	.97	55.6	1.80	68.9	2.14
200 PSI	5.6	1.29	14.0	2.34	17.3	2.84
13.8 BAR	21.2	1.29	53	2.34	65.5	2.84
250 PSI	4.9	1.65	13.4	2.91	16.5	3.48
17.2 BAR	18.5	1.65	50.7	2.91	62.4	3.48
300 PSI	4.3	1.91	12.7	3.47	15.7	4.17
20.7 BAR	16.3	1.91	48.1	3.47	59.4	4.17

FEATURES:

- ◆ Port size: 3/4" NPT
- ◆ 1" hose barb inlet fitting for 1000 rpm operation
- ◆ Max. fluid temperature: 140°F/60°C
- ◆ Housing: Cast Iron (C), Ni-Resist (N) or Silvercast (XL)
- ◆ Shaft rotation: Counter clockwise when looking at the shaft end (clockwise available)
- ◆ Rollers: Super Rollers standard [Poly (T3) and Teflon® (T2)]
- ◆ Shaft Seals: Viton® standard
- ◆ Available PTO adapters: See page 76
- ◆ Recommended PTO torque arm kit 3430-0540
- ◆ Rotor: Cast Iron, Ni-Resist or Silvercast
- ◆ Weight: 9 lbs./4.1 kg

ORDER INFORMATION

Model Number	Max GPM	Max LPM	Max PSI	Max BAR	Max RPM	Shaft Output		
						U.S.	Metric	Shaft
6500C	21.8	82.5	300	20.7	1200	5/8"	15.9 mm	solid
6500N	21.8	82.5	300	20.7	1200	5/8"	15.9 mm	solid
6500XL	21.8	82.5	300	20.7	1200	5/8"	15.9 mm	solid

Teflon® rollers - Add Suffix "T2" - (i.e.: 6500C-T2).
 Polypropylene rollers - Add Suffix "T3" - (i.e.: 6500C-T3).
 Reverse rotation* - Add Suffix "R" - (i.e.: 6500C-R).

CAST IRON, NI-RESIST OR SILVER SERIES XL

Series 7560 8-Roller



Pressure in PSI and BAR	GPM	HP	GPM	HP	GPM	HP
	LPM	HP	LPM	HP	LPM	HP
	@540 RPM		@800 RPM		@1000 RPM	
0 PSI	12	.33	18.3	.89	22.5	1.56
0 BAR	45.4	.33	69.3	.89	85.2	1.56
50 PSI	11.1	.74	17.5	1.26	22	1.78
3.4 BAR	42	.74	66.2	1.26	83.3	1.78
100 PSI	10.3	1.25	16.9	1.95	21.3	2.53
6.9 BAR	39	1.25	64	1.95	80.6	2.53
150 PSI	9.5	1.77	16.1	2.65	20.6	3.5
10.3 BAR	36	1.77	60.9	2.65	78	3.5
200 PSI	8.6	2.26	15.5	3.4	20	4.2
13.8 BAR	32.5	2.26	58.7	3.4	75.7	4.2
250 PSI	7.0	2.78	14.5	4.2	18.9	5.3
17.2 BAR	29.5	2.78	54.9	4.2	71.5	5.3
300 PSI	7.1	3.3	18.9	5.3	18.0	6.1
20.7 BAR	26.9	3.3	51.9	5.3	68.1	6.1

FEATURES:

- ◆ Max. fluid temperature: 140°F/60°C
- ◆ Port sizes: 3/4" NPT
- ◆ 1" hose barb inlet fitting for 1000 rpm operation
- ◆ Housing: Cast Iron (C), Ni-Resist (N) or Silvercast (XL)
- ◆ Shaft rotation: Counter clockwise when looking at the shaft end (clockwise available)
- ◆ Rollers: Super Rollers standard [Poly (T3) and Teflon® (T2)]
- ◆ Shaft Seals: Viton® standard
- ◆ Available PTO adapters: See page 76
- ◆ Recommended PTO torque arm kit 3430-0540
- ◆ Rotor: Cast Iron, Ni-Resist or Silvercast
- ◆ Weight: 13 lbs./5.89 kg

ORDER INFORMATION

Model Number	Max GPM	Max LPM	Max PSI	Max BAR	Max RPM	Shaft Output		
						U.S.	Metric	Shaft
7560C	22.5	85.2	300	26.7	1000	15/16"	23.8 mm	solid
7560N	22.5	85.2	300	26.7	1000	15/16"	23.8 mm	solid
7560XL	22.5	85.2	300	26.7	1000	15/16"	23.8 mm	solid

Teflon® rollers - Add Suffix "T2" - (i.e.: 7560C-T2).
 Polypropylene rollers - Add Suffix "T3" - (i.e.: 7560C-T3).
 Reverse rotation* - Add Suffix "R" - (i.e.: 7560C-R).

Teflon® is a registered trademark of E.I. DuPont de Nemours and Co.
 Viton® is a registered trademark of DuPont. Hypro® is a registered trademark of Pentair.

HYDRAULICALLY-DRIVEN CAST IRON, NI-RESIST OR SILVER SERIES

Series 7560-GM30, 7560-GM15 8-Roller



FEATURES:

- ◆ Hydraulic motor drive (for open center, closed center and load-sensing systems)
- ◆ Max. fluid temperature: 140°F/60°C
- ◆ Pump port size: 3/4" NPT
- ◆ 1" hose barb inlet fitting for 1000 rpm operation
- ◆ Housing: Cast Iron (C), Ni-Resist (N) or Silvercast (XL)
- ◆ Rollers: Super Rollers standard [Poly (T3) and Teflon®(T2)]
- ◆ Shaft Seals: Viton® standard
- ◆ Rotor: Cast Iron, Ni-Resist or Silvercast
- ◆ Motor port size: -10 SAE (7/8"- 14" UNF)

ORDER INFORMATION

Model Number	Max GPM	Max LPM	Max PSI	Max BAR	Max RPM	Motor Capacity Hydraulic Flow Max	
						US	Metric
7560C-GM30	20.8	78.7	300	20.7	1000	12 gpm	45 lpm
7560N-GM30	20.8	78.7	300	20.7	1000	12 gpm	45 lpm
7560XL-GM30	20.8	78.7	300	20.7	1000	12 gpm	45 lpm
7560C-GM15	20.1	76.1	300	20.7	1000	6 gpm	23 lpm
7560N-GM15	20.1	76.1	300	20.7	1000	6 gpm	23 lpm
7560XL-GM15	20.1	76.1	300	20.7	1000	6 gpm	23 lpm

Teflon® rollers - Add Suffix "T2" - (i.e.: 7560C-GM30-T2).
 Polypropylene rollers - Add Suffix "T3" - (i.e.: 7560C-GM30-T3).

7560C,N,XL-GM15

U.S. UNITS

Hyd.GPM	GPM at									
	0 PSI	25 PSI	50 PSI	75 PSI	100 PSI	125 PSI	150 PSI	200 PSI	250 PSI	300 PSI
3	10.6	9.4	8.5	7.7	7.1	6.5	5.8	4.8	3.2	1.6
4	14.1	13.1	12.0	11.3	10.6	10.0	9.3	8.3	6.9	5.2
5	17.4	16.6	15.7	15.0	14.4	13.5	13.2	11.8	10.3	8.7
6	20.8	20.1	19.4	18.6	17.9	17.1	16.5	14.9	13.3	11.8

7560C,N,XL-GM15

METRIC UNITS

Hyd.LPM	LPM at									
	0 Bar	1.7 Bar	3.5 Bar	5.2 Bar	6.9 Bar	8.6 Bar	10.3 Bar	13.8 Bar	17.2 Bar	20.7 Bar
11.4	40.1	35.6	32.2	29.1	26.9	24.6	22.0	18.2	12.1	6.1
15.1	53.4	49.6	45.4	42.8	40.1	37.9	35.2	31.4	26.1	19.7
18.9	65.9	62.8	59.4	56.8	54.5	51.1	50.0	44.7	39.0	32.9
22.7	78.7	76.1	73.4	70.4	67.8	64.7	62.5	56.4	50.3	44.7

7560C,N,XL-GM30

U.S. UNITS

Hyd. GPM	GPM at									
	0 PSI	25 PSI	50 PSI	77 PSI	100 PSI	125 PSI	150 PSI	200 PSI	250 PSI	300 PSI
5	9.0	8.5	7.8	7.3	6.7	6.1	5.5	4.4	3.3	2.2
6	10.5	10.0	9.5	8.9	8.4	7.8	7.3	6.2	5.2	4.1
7	11.9	11.5	11.0	10.4	9.9	9.4	8.9	7.8	6.8	5.7
8	13.7	13.1	12.5	12.0	11.5	10.9	10.4	9.4	8.4	7.3
9	15.2	14.6	14.1	13.6	13.1	12.6	12.1	11.1	10.0	9.1
10	16.9	16.5	15.9	15.4	14.9	14.3	13.9	12.9	11.9	11.0
11	18.6	18.2	17.6	17.1	16.6	16.1	15.6	14.7	13.8	12.9
12	20.1	19.6	19.1	18.6	18.1	17.6	17.1	16.3	15.3	14.5

7560C,N,XL-GM30

METRIC UNITS

Hyd. LPM	LPM at										
	0 BAR	2 BAR	4 BAR	6 BAR	8 BAR	10 BAR	12 BAR	14 BAR	16 BAR	18 BAR	20 BAR
20	35.8	33.2	30.5	28.1	25.6	23.4	20.9	18.5	15.8	12.6	10.0
25	42.8	39.5	36.8	34.0	31.8	29.2	26.2	23.7	21.6	18.9	16.4
30	51.8	49.0	45.8	43.0	40.3	37.9	35.3	33.3	31.1	28.9	26.2
35	58.1	55.8	52.7	50.1	47.7	45.5	43.1	40.9	38.8	36.3	33.5
40	67.6	64.8	62.4	60.0	57.7	55.8	53.4	51.3	48.8	46.6	44.1
45	75.3	72.7	70.4	68.1	66.0	63.8	61.8	59.8	57.8	55.7	53.3

Teflon® is a registered trademark of E.I. DuPont de Nemours and Co.
 Viton® is a registered trademark of DuPont. Hypro® is a registered trademark of Pentair Ltd.

CAST IRON, NI-RESIST OR SILVER SERIES XL

Series 7700 7-Roller



Pressure in PSI and BAR	GPM	HP	GPM	HP	GPM	HP
	LPM	HP	LPM	HP	LPM	HP
	@540 RPM		@600 RPM		@800 RPM	
0 PSI	14.2	.23	15.3	.28	22.1	.37
0 BAR	53.7	.23	57.9	.28	83.6	.37
50 PSI	12.9	.56	14.0	.62	20.7	.86
3.4 BAR	48.8	.56	53	.62	78.3	.86
100 PSI	11.9	1.10	13.0	1.20	19.5	1.66
6.9 BAR	45	1.10	49.2	1.20	73.8	1.66
150 PSI	11.2	1.64	12.3	1.80	18.6	2.40
10.3 BAR	42.4	1.64	46.6	1.80	70.4	2.40
200 PSI	10.3	2.22	11.6	2.44	17.8	3.26
13.8 BAR	39	2.22	43.9	2.44	67.4	3.26

FEATURES:

- ◆ Max. fluid temperature: 140°F/60°C
- ◆ Port size: 3/4" NPT
- ◆ Housing: Cast Iron (C), Ni-Resist (N) or Silvercast (XL)
- ◆ Shaft rotation: Counter clockwise when looking at the shaft end (Clockwise available)
- ◆ Rollers: Super Rollers standard [Poly (T3) and Teflon® (T2)]
- ◆ Shaft Seals: Viton® standard
- ◆ Available PTO adapters: See page 76
- ◆ Recommended PTO torque arm kit 3430-0540
- ◆ Rotor: Cast Iron, Ni-Resist or Silvercast
- ◆ Weight: 14 lbs./6.36 kg

ORDER INFORMATION

Model Number	Max GPM	Max LPM	Max PSI	Max BAR	Max RPM	Shaft Output		
						U.S.	Metric	Shaft
7700C	22.1	83.7	200	13.8	800	15/16"	23.8 mm	solid
7700N	22.1	83.7	200	13.8	800	15/16"	23.8 mm	solid
7700XL	22.1	83.7	200	13.8	800	15/16"	23.8 mm	solid

Teflon® rollers - Add Suffix "T2" - (i.e.: 7700C-T2).
 Polypropylene rollers - Add Suffix "T3" - (i.e.: 7700C-T3).
 Reverse rotation* - Add Suffix "R" - (i.e.: 7700C-R).

CAST IRON, NI-RESIST OR SILVER SERIES XL

Series 1700 5-Roller



Pressure in PSI and BAR	GPM	HP	GPM	HP	GPM	HP
	LPM	HP	LPM	HP	LPM	HP
	@540 RPM		@600 RPM		@1000 RPM	
0 PSI	25.0	2.7	28.0	.34	45.0	1.42
0 BAR	94.6	2.7	106	.34	170	1.42
50 PSI	21.0	1.18	24.5	1.39	43.0	3.0
3.4 BAR	79.5	1.18	92.7	1.39	163	3.0
100 PSI	19.0	2.13	22.0	2.36	41.0	4.67
6.9 BAR	71.9	2.13	83.3	2.36	155	4.67
150 PSI	17.0	2.89	20.0	3.34	39.0	6.07
10.3 BAR	64.3	2.89	75.7	3.34	148	6.07
200 PSI	15.0	3.85	18.0	4.39	----	----
13.8 BAR	56.8	3.85	681	4.39	----	----

FEATURES:

- ◆ Max. fluid temperature: 140°F/60°C
- ◆ Port size: 1" NPT (BSP available on 1700C)
- ◆ Housing: Cast Iron (C), Ni-Resist (N) or Silvercast (XL)
- ◆ Shaft rotation: Counter clockwise when looking at the shaft end (Clockwise available)
- ◆ Rollers: Super Rollers standard [Poly (T3) and Teflon® (T2) available]
- ◆ Shaft Seals: Viton® standard
- ◆ Available PTO adapters (forged steel recommended): See page 76
- ◆ Recommended PTO torque arm kit 3430-0540
- ◆ Rotor: Cast Iron, Ni-Resist or Silvercast
- ◆ Weight: 19 lbs./8.6 kg

ORDER INFORMATION

Model Number	Max GPM	Max LPM	Max PSI	Max BAR	Max RPM	Shaft Output		
						U.S.	Metric	Shaft
1700C*	45	170	200	13.8	1000	15/16"	23.8 mm	solid
1700N	45	170	200	13.8	1000	15/16"	23.8 mm	solid
1700XL	45	170	200	13.8	1000	15/16"	23.8 mm	solid

* BSP Version - 1700C-BT
 Teflon® rollers - Add Suffix "T2" - (i.e.: 1700C-T2).
 Polypropylene rollers - Add Suffix "T3" - (i.e.: 1700C-T3).
 Reverse rotation* - Add Suffix "R" - (i.e.: 1700C-R).

Teflon® is a registered trademark of E.I. DuPont de Nemours and Co.
 Viton® is a registered trademark of DuPont. Hypro® is a registered trademark of Pentair.

CAST IRON, NI-RESIST OR SILVER SERIES XL

Series 1502 6-Roller



FEATURES:

- ◆ Max. fluid temperature: 140°F/60°C
- ◆ Port size: 1-1/2" NPT (BSP available on 1502C)
- ◆ Housing: Cast Iron (C), Ni-Resist (N) or Silvercast (XL)
- ◆ Shaft rotation: Counter clockwise when looking at the shaft end (Clockwise available)
- ◆ Rollers: Super rollers standard [Poly (T3) available]
- ◆ Shaft Seals: Buna-N standard on Cast Iron and Ni-Resist [Viton (Q) available]; Viton® standard on Silver Series XL
- ◆ Available PTO adapters (forged steel recommended): See page 76
- ◆ Recommended PTO Torque Arm Kit 3430-0540
- ◆ Rotor: Cast Iron, Ni-Resist or Silvercast
- ◆ Weight: 30 lbs./13.6 kg

Pressure in PSI and BAR	GPM	HP	GPM	HP	GPM	HP
	LPM	HP	LPM	HP	LPM	HP
	@540 RPM		@600 RPM		@1000 RPM	
0 PSI	33.1	.51	36.8	.66	62.1	2.02
0 BAR	125	.51	139	.66	235	2.02
25 PSI	29.7	1.02	33.6	1.15	58.5	3.04
1.7 BAR	112	1.02	127	1.15	221	3.04
50 PSI	27.8	1.45	31.7	1.68	56.9	3.69
3.4 BAR	105	1.45	120	1.68	215	3.69
100 PSI	24.3	2.46	28.3	2.78	53.9	5.31
6.9 BAR	92	2.46	107	2.78	204	5.31
150 PSI	21.0	3.54	25.0	3.95	50.9	7.12
10.3 BAR	79.5	3.54	94.6	3.95	193	7.12

ORDER INFORMATION

Model Number	Max GPM	Max LPM	Max PSI	Max BAR	Max RPM	Shaft Output		
						U.S.	Metric	Shaft
1502C*	62	235	200	13.8	1000	15/16"	23.8 mm	solid
1502N	62	235	200	13.8	1000	15/16"	23.8 mm	solid
1502XL	62	235	200	13.8	1000	15/16"	23.8 mm	solid

*BSP Version - 1502C-BT
 Teflon® rollers - Add Suffix "T2" - (i.e.: 1502C-T2).
 Polypropylene rollers - Add Suffix "T3" - (i.e.: 1502C-T3).
 Reverse rotation* - Add Suffix "R" - (i.e.: 1502C-R).

CAST IRON OR SILVER SERIES XL, GAS ENGINE DRIVEN

Models: 4101C-25, 4101XL-25



FEATURES:

- ◆ 2.5 HP PowerPro Engine (CARB/EPA approved)
- ◆ Port size: 3/4" NPT
- ◆ Housing: Cast Iron (C) or Silvercast (XL)
- ◆ Rollers: Super rollers standard [Poly (T3) and Teflon® (T2)]
- ◆ Shaft Seals: Viton® standard
- ◆ Rotor: Cast Iron (C) or Silvercast (XL)
- ◆ Weight: 29 lbs./13.1 kg

Pressure in PSI and BAR	GPM
BAR	LPM
0 PSI	8.9
0 BAR	34
50 PSI	8.6
3.4 BAR	33
100 PSI	8.3
6.9 BAR	31
150 PSI	8.0
10.3 BAR	30

ORDER INFORMATION

Model Number	Max GPM	Max LPM	Max PSI	Max BAR	Engine Mfr. & HP
4101C-25	8.9	34.7	100	6.9	PowerPro 2.5 hp
4101XL-25	8.9	34.7	150	10.3	PowerPro 2.5 hp

Teflon® is a registered trademark of E. I. DuPont de Nemours and Co.
 Viton® is a registered trademark of DuPont. Hypro® is a registered trademark of Pentair.

ROLLER PUMP KITS & ACCESSORIES

ROLLER PUMP ACCESSORY SELECTION GUIDE

Description	Series 1500	Series 1700	Series 6500	Series 7560	Series 7700	Series 4000	Series 5200
1000 rpm 1-3/4" Forged Steel PTO Adapter	1320-0080	1320-0080	-----	1320-0080	-----	-----	-----
540 rpm 1-3/8" Quick Coupler	1323-0072	1323-0072	-----	1323-0072	1323-0072	-----	-----
1000 rpm 1-3/8" Quick Coupler	1323-0073	1323-0073	-----	1323-0073	-----	-----	-----
Multi-Speed 1-3/8" Quick Coupler	1323-0076	1323-0076	1321-0012	1321-0013	1321-0013	1321-0012	-----
Steel Shaft Adapter 3/4" x 5/8"	-----	-----	1320-0015	-----	-----	1320-0015	-----
Steel Shaft Adapter 5/8" x 5/8"	-----	-----	1320-0016	-----	-----	1320-0016	-----
Steel Shaft Adapter 540 rpm x 1"	-----	-----	-----	-----	-----	-----	1320-0081
Repair Kits	3430-0387 3430-0386	3430-0437	3430-0380	3430-0381	3430-0384	3430-0390	-----
Torque Arm Kit	-----	3430-0540	3430-0540	3430-0540	3430-0540	-----	-----
Base Kits	3420-0004	3420-0010	3420-0023	3420-0003	3420-0010	3420-0024* 3420-0025**	-----
Hydraulic Flange Kit	-----	-----	-----	3430-0636	-----	-----	-----

* For electric motor drive 3 1/2" shaft centerline (4001, 4101).

** For gas engine drive 43/16" shaft centerline (4101 only).

ROLLER REPAIR KITS

Kit Number	Pump Series	Description	Estimated Weight Ea.	
			US Units	Metric Units
3430-0387	1502C and 1502N	Roller kit includes: 6 Super Rollers, 1 o-ring gasket, and 2 Buna-N seals	1 lb. 7 oz.	652 g
3430-0386	1502XL	Roller kit includes: 6 Super Rollers, 1 o-ring gasket, and 2 Viton® seals	1 lb. 8 oz.	680 g
3430-0437	1700	Roller kit includes: 5 Super Rollers, 1 o-ring gasket, and 2 Viton® seals	1 lb. 5 oz.	595 g
3430-0380	6500	Roller kit includes: 6 Super Rollers, 1 o-ring gasket, and 2 Viton® seals	8 oz.	227 g
3430-0381	7560/7700	Roller kit includes: 8 Super Rollers, 1 o-ring gasket, and 2 Viton® seals	12 oz.	340 g
3430-0390	4001/4101	Roller kit includes: 4 Super Rollers, 1 o-ring gasket, and 2 Viton® seals	3 oz.	85 g

BASE KITS

Kit Number	Pump Series	Description	Estimated Weight Ea.	
			US Units	Metric Units
3420-0025	4101	Base kit for mounting to gas engine, 4-3/16" shaft centerline. Base kit includes: 1 Base, 2 Bolts and 2 Lock washers	12 oz.	340 g
3420-0024	4001/4101	Base kit for mounting to an electric motor, 3-1/2" shaft centerline. Base kit includes: 1 Base, 2 Bolts and 2 Lock washers	7 oz.	198 g
3420-0023	6500	Base kit includes: 1 Base, 2 Bolts and 2 Lock washers	12 oz.	340 g
3420-0003	7560	Base kit includes: 1 Base, 3 Bolts and 3 Lock washers	1 lb. 10 oz.	737 g
3420-0010	7700/1700	Base kit includes: 1 Base and 4 Bolts	14 oz.	397 g
3420-0004	1500	Base kit includes: 1 Base and 4 Bolts	6 lbs.	2.7 kg

PTO AND SHAFT ADAPTERS (FEMALE TO FEMALE)



Part Number	US	Metric	US	Metric	Material	RPM	Pump Model
	PTO (I.D.)	PTO (I.D.)	Pump End (I.D.)	Pump End (I.D.)			
1320-0015	3/4"	19 mm	5/8"	19 mm	steel	*	4000, 6500
1320-0016	5/8"	15.9 mm	5/8"	15.9 mm	steel	*	4000, 6500
1320-0054	3/4"	19 mm	15/16"	23.8 mm	die cast	*	1500, 1700, 7560, 7700

* Refer to recommended pump rpm.

QUICK COUPLERS (FEMALE TO FEMALE)



Part Number	PTO (I.D.)		Pump End (I.D.)		Material	RPM	Pump Model
	US	Metric	US	Metric			
1323-0072	1-3/8" (6 spline)	34.9 mm (6 spline)	15/16"	23.8 mm	forged steel	540	1500, 1700, 7560, 7700
1323-0073	1-3/8" (21 spline)	34.9 mm (21 spline)	15/16"	23.8 mm	forged steel	1000	1500, 1700, 7560
1321-0012*	1-3/8" multi-speed)	34.9 mm (multi-speed)	5/8"	15.9 mm	Die cast	540/1000	4000, 6500
1321-0013*	1-3/8" (multi-speed)	34.9 mm (multi-speed)	15/16"	23.8 mm	Die cast	540/1000	7560, 7700
1323-0076*	1-3/8" (multi-speed)	34.9 mm (multi-speed)	15/16"	23.8 mm	forged steel	540/1000	1500, 1700, 7560, 7700
1323-0078	1-1/2" (8 spline)	38 mm (8 spline)	5/8"	15.9 mm	forged steel	1000	4000, 6500
1323-0079	1-1/2" (8 spline)	38 mm (8 spline)	15/16"	23.8 mm	forged steel	1000	1500, 1700, 7560

* Multi-speed couplers are compatible with both 6 and 21 spline PTO shafts, refer to OIPM for recommend pump RPM.



TORQUE ARM KIT (PUMP NOT INCLUDED)

Part Number	Material	RPM	For Pump Series	Estimated Weight Each	
				US Units	Metric
3430-0540	steel	540/1000	1502, 1700, 6500, 7560, and 7700	2 lbs. 4 oz.	1.02 kg

OTHER PUMP ACCESSORIES

COUPLERS



Inches	mm
1/8"	3.2 mm
3/16"	4.7 mm
1/4"	6.4 mm
1/2"	13 mm
5/8"	15.9 mm
3/4"	19 mm
7/8"	22.2 mm
15/16"	23.8 mm
1"	25.4 mm
1-1/8"	28.6 mm

Note:

These couplers are designed for inch dimensional shafts and keys. Metric dimensions are for reference only (except for 2739-1009).

Series	Part Number	Description	Estimated Weight Each	
			US Units	Metric
2738 (2.0 hp limit)*	2738-1001	1/2" coupling end, with 1/8" keyway	6 oz.	170 g
	2738-1002	5/8" coupling end, with 3/16" keyway	6 oz.	170 g
	2738-1003	3/4" coupling end, with 3/16" keyway	6 oz.	170 g
	2738-1004	7/8" coupling end, with 3/16" keyway	6 oz.	170 g
Replaces L-075	2728-1001	Center disc	1 oz.	28 g
2739 (5.0 hp limit)*	2739-1001	5/8" coupling end, with 3/16" keyway	11 oz.	312 g
	2739-1002	3/4" coupling end, with 3/16" keyway	11 oz.	312 g
	2739-1003	7/8" coupling end, with 3/16" keyway	11 oz.	312 g
	2739-1004	15/16" coupling end, with 1/4" keyway	11 oz.	312 g
	2739-1005	1" coupling end, with 1/4" keyway	11 oz.	312 g
	2739-1006	1-1/8" coupling end, with 1/4" keyway	11 oz.	312 g
	2739-1009	24 mm coupling end, with 8mm keyway	11 oz.	312 g
	2729-1001	Center disc	1 oz.	28 g
	Replaces L-095	2729-1005	Heavy-duty center disc, urethane material	1 oz.
2741 (10.5 hp limit)*	2741-1001	3/4" coupling end, with 3/16" keyway	1 lb. 5 oz.	595 g
	2741-1004	15/16" coupling end, with 1/4" keyway	1 lb. 5 oz.	595 g
	2741-1002	1" coupling end, with 1/4" keyway	1 lb. 5 oz.	595 g
	2741-1005	1-1/4" coupling end, with 1/4" keyway	1 lb. 5 oz.	595 g
	2741-1007	1-3/8" coupling end, with 5/16" keyway	1 lb. 5 oz.	595 g
	2741-1003	1-1/8" coupling end, with 1/4" keyway	1 lb. 5 oz.	595 g
	2729-1002	Center disc	1 oz.	28 g
Replaces L-100	2729-1006	heavy-duty center disc, urethane material	1 oz.	28g
2740 (18.0 hp limit)*	2740-1001	3/4" coupling end, with 3/16" keyway	3 lbs. 11 oz.	1.67 kg
	2740-1002	1" coupling end, with 1/4" keyway	3 lbs. 8 oz.	1.59 kg
	2740-1005	1-3/8" coupling end, with 5/16" keyway	3 lbs.	1.4 kg
	2740-1007	1-1/8" coupling end, with 1/4" keyway	2 lbs. 15 oz.	1.33 kg
Replaces L-110	2729-1003	Center disc	3 oz.	85 g

* HP limit is electric motor hp at 1725 rpm for driving a steady uniform load. For an uneven load, stop-start and moderate shock loads, divide hp by a 1.5 service factor.

ORDERING INSTRUCTIONS:

To order one 1/2" x 3/4" Series 2738 coupling, specify the following:

Note: It is not necessary to order in complete sets, parts can be ordered individually.

Quantity	Part Number	Description
1	2738-1001	1/2" coupling end
1	2738-1003	3/4" coupling end
1	2728-1001	Center disc

RELIEF VALVES



Part Number	Ports-NPT Inlet (M) Outlet (F)	Max. PSI	Max. BAR	Body Material	Valve Material	Estimated Weight Each	
						US Units	Metric
3300-0002	1/2" M x 1/2" F	200	14	cast bronze	stainless steel ball	10 oz.	283 g
3300-0001	3/4" M x 3/4" F	400	28	cast bronze	stainless steel ball	1 lb. 1 oz.	482 g
3301-0001	3/4" M x 3/4" F	400	28	cast bronze	flat neoprene	1 lb. 2 oz.	510 g
3300-0093	3/4" M x 3/4" F	300	20	cast bronze	stainless steel ball	1 lb. 2 oz.	510 g
3300-0094	1" M x 3/4" F	150	10	cast bronze	stainless steel ball	1 lb. 4 oz.	567 g
3316-0002	1-1/4"	200	14	cast iron	stainless steel cone	2 lbs. 14 oz.	1.3 kg
3300-0015	3/4" M - 3/4" F	150	10	nylon	nylon	6 oz.	170 g
3300-0016	3/4" M - 3/4" F	250	17	nylon	nylon	6 oz.	170 g
3300-0098	3/4" M - 3/4" F	400	28	nylon	nylon	6 oz.	170 g

POLY DIAPHRAGM PUMP SERIES

Series 9910-DP423, DP573, and DP763



FEATURES:

- ◆ Glass-filled polypropylene construction of head, manifold and control components for the maximum in chemical resistance
- ◆ Flow rate up to 11.5 gpm (43.3 lpm), 15.6 gpm (59 lpm) and 20.2 gpm (76.5 lpm) pressure up to 290 psi (20 bar)
- ◆ 3 cylinder design eliminates the need for pulsation dampening devices and lengthens the life of the entire pumping system
- ◆ Kynar™ and 300 series stainless steel valve design for higher flow and better corrosion resistance
- ◆ The external inlet and outlet manifold design vs. an internal manifold design allows for easy valve replacement and lower cost repairs

ORDER INFORMATION

Model Number	Max GPM	Max LPM	Max PSI	Max BAR	Port Size	Description
9910-DP423	11.5	43.3	290	20	1 1/4" Inlet 1" Outlet	Poly Diaphragm Pump (3/4" x 1 5/8" long keyed shaft)
9910-DP423GRGI	11.5	43.3	290	20		Poly Diaphragm Pump with Gearbox and Control Unit
9910-DP573	15.6	59.1	290	20	1 1/2" Inlet 1" outlet	Poly Diaphragm Pump (3/4" x 1 5/8" long keyed shaft)
9910-DP573GRGI	15.6	59.1	290	20		Poly Diaphragm Pump with Gearbox and Control Unit
9910-DP763	20.2	76.4	290	20	1 1/2" Inlet 1" outlet	Poly Diaphragm Pump (3/4" x 1 5/8" long keyed shaft)
9910-DP763GRGI	20.2	76.4	290	20		Poly Diaphragm Pump with Gearbox and Control Unit
9910-GS25	Control Unit (DP 423)					
9910-GS35S	Control Unit (DP573 & DP763)					

DP423

Pressure in PSI and BAR	GPM	HP	GPM	HP	GPM	HP	GPM	HP	GPM	HP
	LPM	HP	LPM	HP	LPM	HP	LPM	HP	LPM	HP
	@350 RPM		@400 RPM		@450 RPM		@500 RPM		@550 RPM	
0 PSI	7.5	0.18	8.5	0.20	9.4	0.29	10.5	0.35	11.5	0.42
0 BAR	28.3	0.18	32.2	0.20	35.6	0.29	39.5	0.35	43.3	0.42
72 PSI	7.3	0.46	8.3	0.53	9.2	0.61	10.2	0.68	11.0	0.77
5 BAR	27.4	0.46	31.2	0.53	34.6	0.61	38.5	0.68	41.5	0.77
145 PSI	7.2	0.77	8.2	0.87	9.1	0.98	10.1	1.11	11.0	1.21
10 BAR	27.3	0.77	31.1	0.87	34.5	0.98	38.2	1.11	41.4	1.21
217 PSI	7.0	1.06	8.1	1.21	9.1	1.37	10.0	1.51	10.8	1.68
15 BAR	26.5	1.06	30.5	1.21	34.5	1.37	37.7	1.51	40.7	1.68
290 PSI	6.9	1.33	7.8	1.53	9.1	1.74	9.8	1.93	10.6	2.14
20 BAR	26.0	1.33	29.5	1.53	34.2	1.74	37.0	1.93	40.1	2.14

DP573

Pressure in PSI and BAR	GPM	HP	GPM	HP	GPM	HP	GPM	HP	GPM	HP
	LPM	HP	LPM	HP	LPM	HP	LPM	HP	LPM	HP
	@350 RPM		@400 RPM		@450 RPM		@500 RPM		@550 RPM	
0 PSI	10.4	0.14	11.7	0.17	13.0	0.24	14.3	0.32	15.6	0.43
0 BAR	39.5	0.10	44.3	0.13	49.1	0.18	54.3	0.24	59.1	0.32
72 PSI	10.3	0.54	11.6	0.62	12.6	0.67	14.2	0.77	15.5	0.83
5 BAR	39.0	0.40	43.8	0.46	47.7	0.50	53.9	0.57	58.6	0.62
145 PSI	10.1	0.95	11.4	1.09	12.6	1.22	14.1	1.28	15.2	1.41
10 BAR	38.4	0.71	43.0	0.81	47.6	0.91	53.3	0.95	57.5	1.05
217 PSI	9.9	1.33	11.1	1.50	12.5	1.71	13.9	1.89	14.9	2.07
15 BAR	37.3	0.99	41.9	1.12	47.4	1.28	52.7	1.41	56.4	1.54
290 PSI	9.7	1.60	10.8	1.88	12.5	2.14	13.8	2.43	14.8	2.64
20 BAR	36.8	1.19	40.9	1.40	47.3	1.60	52.3	1.81	56.1	1.97

DP763

Pressure in PSI and BAR	GPM	HP	GPM	HP	GPM	HP	GPM	HP	GPM	HP
	LPM	HP	LPM	HP	LPM	HP	LPM	HP	LPM	HP
	@350 RPM		@400 RPM		@450 RPM		@500 RPM		@550 RPM	
0 PSI	13.7	0.20	15.3	0.29	17.1	0.39	18.8	0.51	20.2	0.63
0 BAR	51.8	0.15	57.8	0.22	64.9	0.29	71.0	0.38	76.4	0.47
72 PSI	13.4	0.71	15.2	0.77	16.8	0.90	18.4	0.98	20.1	1.11
5 BAR	50.9	0.53	57.6	0.57	63.5	0.67	69.8	0.73	76.0	0.83
145 PSI	13.3	1.21	15.0	1.39	16.7	1.58	18.4	1.76	19.9	1.93
10 BAR	50.5	0.90	56.8	1.04	63.4	1.18	69.7	1.31	75.4	1.44
217 PSI	12.8	1.76	14.9	2.02	16.7	2.25	18.1	2.50	19.5	2.75
15 BAR	48.5	1.31	56.3	1.51	63.1	1.68	68.6	1.86	73.9	2.05
290 PSI	12.7	2.12	14.6	2.49	16.5	2.77	18.0	3.12	19.4	3.45
20 BAR	48.0	1.58	55.4	1.86	62.3	2.07	68.2	2.33	73.4	2.57

Kynar™ is a registered trademark of Arkema, Inc.
Hypro™ is a registered trademark of Pentair.

LOW PRESSURE, 2 DIAPHRAGM

Model 9910-D70 and D70GR



FEATURES:

- ◆ Max. fluid temperature: 140°F/60°C
- ◆ Port sizes: 1-1/4" inlet, 1" outlet, hose barb
- ◆ Diaphragms: 2, semi-hydraulic, Desmopan® standard, Buna available
- ◆ Housing components for liquid handling: epoxy-coated
- ◆ Pump shaft rotation: CW and CCW
- ◆ For shaft kits and other drive options, see pages 91-92
- ◆ Recommended control unit: 3300-0087 or 3300-0088, see page 93
- ◆ Weight: 22 lbs./10 kg (D70); 31 lbs./14 kg (D70GR)

Pressure in PSI and BAR	GPM	HP	GPM	HP	GPM	HP	GPM	HP	GPM	HP
	LPM	HP	LPM	HP	LPM	HP	LPM	HP	LPM	HP
	@350 RPM		@400 RPM		@450 RPM		@500 RPM		@550 RPM	
0 PSI	13.6	0.33	15.1	0.40	16.9	0.48	18.4	0.58	19.6	0.80
0 BAR	51.2	0.33	57.1	0.40	63.7	0.48	69.4	0.58	74.1	0.80
72 PSI	11.2	0.73	12.7	0.79	14.1	0.91	15.6	1.01	17.0	1.09
5 BAR	42.3	0.73	47.9	0.79	53.2	0.91	58.8	1.01	64.3	1.09
145 PSI	11.0	1.20	12.4	1.39	13.9	1.63	15.2	1.66	16.6	1.91
10 BAR	41.4	1.20	46.9	1.39	52.6	1.63	57.3	1.66	62.7	1.91
217 PSI	10.7	1.71	12.3	2.10	13.8	2.19	15.1	2.36	16.3	2.63
15 BAR	40.4	1.71	46.3	2.10	52.2	2.19	57.1	2.36	61.6	2.63
290 PSI	10.6	2.18	12.1	2.46	13.7	2.77	15.0	3.12	16.1	3.39
20 BAR	40.0	2.18	45.7	2.46	51.8	2.77	56.7	3.12	60.6	3.39

All HP requirements listed in the table are electrical.
For approximate gasoline equivalent, multiply by 1.3.

ORDER INFORMATION

Model Number	Max GPM	Max LPM	Max PSI	Max BAR	Max RPM	Shaft Output
9910-D70	19.6	74.2	290	20	550	Select shaft kit for desired drive
9910-D70GR	19.6	74.2	290	20	3600	3/4" hollow shaft w/ gear reduction for 5 hp gas engine

LOW PRESSURE, 3 DIAPHRAGM

Model 9910-D115 and D115GR34



FEATURES:

- ◆ Max. fluid temperature: 140°F/60°C
- ◆ Port sizes: 1-1/2" inlet, 1" outlet, hose barb
- ◆ Diaphragms: 3, semi-hydraulic, Desmopan® standard, Buna available
- ◆ Housing components for liquid handling: epoxy-coated
- ◆ Pump shaft rotation: CW and CCW
- ◆ For shaft kits and other drive options, see pages 91-92
- ◆ Recommended control unit: 3300-0087 or 3300-0088, see page 93
- ◆ Weight: 35 lbs./15.9 kg (D115); 44 lbs./20 kg (D115GR34)

Pressure in PSI and BAR	GPM	HP	GPM	HP	GPM	HP	GPM	HP	GPM	HP
	LPM	HP	LPM	HP	LPM	HP	LPM	HP	LPM	HP
	@350 RPM		@400 RPM		@450 RPM		@500 RPM		@550 RPM	
0 PSI	18.9	0.33	21.4	0.40	23.9	0.45	26.4	0.69	28.6	0.91
0 BAR	71.5	0.33	80.9	0.40	90.1	0.45	99.7	0.69	107.9	0.91
72 PSI	18.6	1.13	20.7	1.18	23.4	1.40	25.5	1.62	27.9	1.83
5 BAR	70.0	1.13	78.2	1.18	88.5	1.40	96.1	1.62	105.3	1.83
145 PSI	18.3	1.89	20.5	2.13	23.2	2.47	25.3	2.82	27.7	2.99
10 BAR	69.0	1.89	77.4	2.13	87.5	2.47	95.6	2.82	104.4	2.99
217 PSI	18.2	2.72	20.4	3.11	23.1	3.51	25.1	3.88	27.6	4.33
15 BAR	68.6	2.72	77.0	3.11	87.0	3.51	94.7	3.88	104.0	4.33
290 PSI	18.0	3.45	20.3	3.98	22.9	4.54	25.0	5.09	27.5	5.51
20 BAR	68.0	3.45	76.7	3.98	86.2	4.54	94.2	5.09	103.8	5.51

All HP requirements listed in the table are electrical. For approximate gasoline equivalent, multiply by 1.3.

Desmopan® is a registered trademark of Bayer Aktiengesellschaft, Farbenfabriken. Hypro® is a registered trademark of Pentair.

ORDER INFORMATION

Model Number	Max GPM	Max LPM	Max PSI	Max BAR	Max RPM	Shaft Output
9910-D115	28.6	108.3	290	20	550	Select shaft kit for desired drive
9910-D115GR34	28.6	108.3	290	20	3600	3/4" hollow shaft w/ gear reduction for 5 hp gas engine

LOW PRESSURE, 3 DIAPHRAGM

Model 9910-D135



FEATURES:

- ◆ Max. fluid temperature: 140°F/60°C
- ◆ Port sizes: 1-1/2" inlet, 1" outlet, hose barb
- ◆ Diaphragms: 3, semi-hydraulic, Desmopan® standard, Buna available
- ◆ Housing components for liquid handling: epoxy-coated
- ◆ Pump shaft rotation: CW and CCW
- ◆ Recommended control unit: 3300-0087 or 3300-0088, see page 93
- ◆ Weight: 38 lbs./17.2 kg

ORDER INFORMATION

Pressure in PSI and BAR	GPM		HP		GPM		HP		GPM		HP	
	LPM	HP	LPM	HP	LPM	HP	LPM	HP	LPM	HP	LPM	HP
	@350 RPM		@400 RPM		@450 RPM		@500 RPM		@550 RPM			
0 PSI	22.6	0.51	25.8	0.69	28.8	0.92	31.5	1.22	33.9	1.45		
0 BAR	85.4	0.51	97.3	0.69	108.8	0.92	118.8	1.22	128.0	1.45		
72 PSI	22.2	1.31	25.3	1.64	28.3	1.84	31.2	2.09	33.3	2.44		
5 BAR	83.8	1.31	95.6	1.64	106.7	1.84	117.6	2.09	125.8	2.44		
145 PSI	22.1	2.29	25.2	2.65	28.2	2.97	31.1	3.45	33.2	3.88		
10 BAR	83.4	2.29	95.2	2.65	106.3	2.97	117.2	3.45	125.3	3.88		
217 PSI	22.0	3.21	25.1	3.80	28.0	4.31	30.8	4.80	33.1	5.32		
15 BAR	83.0	3.21	94.6	3.80	105.7	4.31	116.3	4.80	124.9	5.32		
290 PSI	21.7	4.23	24.8	4.88	27.9	5.45	30.7	6.21	33.0	6.84		
20 BAR	81.9	4.23	93.4	4.88	105.3	5.45	115.7	6.21	124.6	6.84		

Model Number	Max GPM	Max LPM	Max PSI	Max BAR	Max RPM	Shaft Output
9910-D135	33.9	128.3	290	20	550	1-3/8"-6 splined male shaft

All HP requirements listed in the table are electrical. For approximate gasoline equivalent, multiply by 1.3.

LOW PRESSURE, 4 DIAPHRAGM

Model 9910-D160



FEATURES:

- ◆ Max. fluid temperature: 140°F/60°C
- ◆ Port sizes: 2" inlet, 1-1/2" outlet, hose barb
- ◆ Diaphragms: 4, semi-hydraulic, Desmopan® standard, Buna available
- ◆ Housing components for liquid handling: epoxy-coated
- ◆ Pump shaft rotation: CW and CCW
- ◆ For hydraulic drive adaption, see page 92
- ◆ Recommended control unit: 3300-0087 or 3300-0088, see page 93
- ◆ Weight: 66 lbs./30 kg

ORDER INFORMATION

Pressure in PSI and BAR	GPM		HP		GPM		HP		GPM		HP	
	LPM	HP	LPM	HP	LPM	HP	LPM	HP	LPM	HP	LPM	HP
	@350 RPM		@400 RPM		@450 RPM		@500 RPM		@550 RPM			
0 PSI	27.9	0.61	32.1	0.80	35.1	1.03	38.9	1.33	41.9	1.68		
0 BAR	105.3	0.61	121.0	0.80	132.3	1.03	146.6	1.33	158.1	1.68		
72 PSI	26.4	1.51	30.0	1.73	33.6	2.01	37.1	2.18	40.9	2.50		
5 BAR	99.7	1.51	113.1	1.73	127.0	2.01	139.9	2.18	154.2	2.50		
145 PSI	25.4	2.48	28.7	2.91	32.6	3.28	35.7	3.74	38.9	4.13		
10 BAR	95.7	2.48	108.5	2.91	122.9	3.28	134.8	3.74	146.8	4.13		
217 PSI	24.3	3.45	27.7	4.06	31.0	4.58	34.4	5.13	37.6	5.73		
15 BAR	91.8	3.45	104.5	4.06	117.0	4.58	129.8	5.13	141.9	5.73		
290 PSI	23.6	4.50	26.9	5.18	30.2	5.86	33.7	6.45	36.8	7.26		
20 BAR	89.1	4.50	101.6	5.18	114.1	5.86	127.0	6.45	138.9	7.26		

Model Number	Max GPM	Max LPM	Max PSI	Max BAR	Max RPM	Shaft Output
9910-D160	41.9	155.1	290	20	550	1-3/8"-6 splined male shaft

All HP requirements listed in the table are electrical. For approximate gasoline equivalent, multiply by 1.3. Desmopan® is a registered trademark of Bayer Aktiengesellschaft, Farbenfabriken. Hypro® is a registered trademark of Pentair.

LOW PRESSURE, 6 DIAPHRAGM

Model 9910-D250



FEATURES:

- ◆ Max. fluid temperature: 140°F/60°C
- ◆ Port sizes: 2" inlet, 1-1/2" outlet, hose barb
- ◆ Diaphragms: 6, semi-hydraulic, Desmopan® standard, Buna available
- ◆ Housing components for liquid handling: epoxy-coated
- ◆ Mounting base: included
- ◆ Pump shaft rotation: CW and CCW
- ◆ For hydraulic drive adaption, see page 92
- ◆ Recommended control unit: 3300-0082, see page 93
- ◆ Weight: 92 lbs./41.7 kg

ORDER INFORMATION

Pressure in PSI and BAR	GPM	HP	GPM	HP	GPM	HP	GPM	HP	GPM	HP
	LPM	HP	LPM	HP	LPM	HP	LPM	HP	LPM	HP
	@350 RPM		@400 RPM		@450 RPM		@500 RPM		@550 RPM	
0 PSI	42.7	0.71	48.3	0.90	54.3	1.22	59.8	1.60	65.7	2.01
0 BAR	161.2	0.71	182.5	0.90	204.8	1.22	225.7	1.60	248.1	2.01
72 PSI	41.4	2.33	47.2	2.73	52.7	3.10	58.1	3.45	63.3	3.88
5 BAR	156.1	2.33	178.2	2.73	198.9	3.10	219.4	3.45	239.0	3.88
145 PSI	40.1	4.09	45.9	4.73	52.1	5.27	56.6	6.02	61.3	6.45
10 BAR	151.4	4.09	173.1	4.73	196.4	5.27	213.8	6.02	231.2	6.45
217 PSI	39.3	5.70	45.1	6.58	50.7	7.45	55.5	8.32	60.2	9.22
15 BAR	148.5	5.70	170.0	6.58	191.5	7.45	209.5	8.32	227.1	9.22
290 PSI	38.8	7.52	44.5	8.45	50.1	9.66	54.8	10.89	59.2	11.54
20 BAR	146.4	7.52	167.9	8.45	189.0	9.66	206.9	10.89	223.4	11.54

Model Number	Max GPM	Max LPM	Max PSI	Max BAR	Max RPM	Shaft Output
9910-D250	65.7	248.7	290	20	550	1-3/8" - 6 splined male shaft

All HP requirements listed in the table are electrical. For approximate gasoline equivalent, multiply by 1.3.

MEDIUM PRESSURE, 2 DIAPHRAGM

Model 9910-D252, D252GRGI, D252GRGI58 and D252GRGIAP



FEATURES:

- ◆ Max. fluid temperature: 140°F/60°C
- ◆ Diaphragms: 2, semi-hydraulic, Desmopan® standard, Buna available
- ◆ Housing: anodized aluminum
- ◆ Mounting base: included
- ◆ Recommended control unit: 9910-KIT1990, see page 93
- ◆ Weight: 14 lbs./6.4 kg (GRGI models); 12 lbs./5.4 kg (D252)
- ◆ Gas engine versions on page 88

ORDER INFORMATION

Pressure in PSI and BAR	GPM	HP	GPM	HP	GPM	HP	GPM	HP	GPM	HP
	LPM	HP	LPM	HP	LPM	HP	LPM	HP	LPM	HP
	@450 RPM		@500 RPM		@550 RPM		@600 RPM		@650 RPM	
0 PSI	4.8	0.15	5.4	0.19	5.9	0.23	6.1	0.25	6.5	0.27
0 BAR	18.0	0.15	20.5	0.19	22.4	0.23	23.1	0.25	24.6	0.27
72 PSI	4.1	0.33	4.6	0.37	5.0	0.42	5.5	0.45	5.9	0.46
5 BAR	15.3	0.33	17.3	0.37	18.7	0.42	20.8	0.45	22.2	0.46
145 PSI	4.0	0.49	4.4	0.57	4.8	0.64	5.3	0.65	5.6	0.72
10 BAR	14.9	0.49	16.6	0.57	18.1	0.64	19.8	0.65	21.3	0.72
217 PSI	3.9	0.66	4.3	0.76	4.7	0.82	5.2	0.89	5.5	0.97
15 BAR	14.7	0.66	16.4	0.76	17.9	0.82	19.6	0.89	20.9	0.97
290 PSI	3.8	0.84	4.2	0.94	4.6	1.02	5.1	1.12	5.4	1.21
20 BAR	14.5	0.84	16.0	0.94	17.4	1.02	19.4	1.12	20.5	1.21

Model Number	Max GPM	Max LPM	Max PSI	Max BAR	Max RPM	Port Size	Shaft Output
9910-D252	6.5	24.6	290	20	650	3/4" HB inlet, 1/2" HB outlet	3/4" solid keyed shaft
9910-D252GRGI	6.5	24.6	290	20	3600	3/4" HB inlet, 3/8" HB outlet	3/4" hollow shaft
9910-D252GRGI58	5.5	20.8	290	20	3600	3/4" HB inlet, 3/8" HB outlet	5/8" hollow shaft
9910-D252GRGIAP	6.5	24.6	290	20	3600	3/4" HB inlet, 3/8" HB outlet	3/4" hollow input shaft with 5/8" output solid shaft

All HP requirements listed in the table are electrical. For approximate gasoline equivalent, multiply by 1.3.

Desmopan® is a registered trademark of Bayer Aktiengesellschaft, Farbenfabriken. Hypro® is a registered trademark of Pentair.

MEDIUM PRESSURE, 2 DIAPHRAGM

Model 9910-D30, D30AP-A, D30GRGI and D30-B-GRGI



FEATURES:

- ◆ Max. fluid temperature: 140°F/60°C
- ◆ Shaft: flanged for shaft kit (D30); flanged w/ 3/4" shaft ext. (D30AP-A); 3/4" hollow shaft for gas engine mount (D30GRGI)
- ◆ Diaphragms: 2, semi-hydraulic, Desmopan® standard, Buna available
- ◆ Housing components for liquid handling: epoxy-coated
- ◆ Pump shaft rotation: CW and CCW
- ◆ For shaft kits and other drive options, see pages 91-92
- ◆ Recommended control unit: 9910-GS40GI, see page 93
- ◆ Weight: 23 lbs./10.4 kg (D30); 33 lbs./15.0 kg (D30GRGI and D30-B-GRGI); 24 lbs./10.9 kg (D30AP-A)
- ◆ Gas engine versions on page 88

ORDER INFORMATION

Pressure in PSI and BAR	GPM	HP	GPM	HP	GPM	HP	GPM	HP	GPM	HP
	LPM	HP	LPM	HP	LPM	HP	LPM	HP	LPM	HP
	@350 RPM		@400 RPM		@450 RPM		@500 RPM		@550 RPM	
0 PSI	6.1	0.13	6.9	0.16	7.8	0.19	8.7	0.24	9.6	0.28
0 BAR	23.0	0.13	26.1	0.16	29.5	0.19	32.8	0.24	36.2	0.28
145 PSI	5.7	0.55	6.6	0.66	7.2	0.76	8.1	0.85	9.3	0.90
10 BAR	21.4	0.55	24.9	0.66	27.3	0.76	30.6	0.85	34.9	0.90
290 PSI	5.6	1.00	6.3	1.14	7.1	1.29	7.8	1.47	8.8	1.64
20 BAR	21.0	1.00	23.7	1.14	26.7	1.29	29.5	1.47	33.4	1.64
465 PSI	5.5	1.46	5.9	1.67	6.9	1.89	7.7	2.06	8.6	2.27
30 BAR	20.6	1.46	22.4	1.67	26.0	1.89	29.0	2.06	32.5	2.27
580 PSI	5.2	1.90	5.8	2.11	6.8	2.41	7.5	2.71	8.3	2.94
40 BAR	19.5	1.90	22.1	2.11	25.8	2.41	28.2	2.71	31.4	2.94

All HP requirements listed in the table are electrical.
For approximate gasoline equivalent, multiply by 1.3.

Model Number	Max GPM	Max LPM	Max PSI	Max BAR	Max RPM	Port Size
9910-D30	9.6	36.3	580	40	550	1" HB inlet, 1/2" HB outlet
9910-D30AP-A	Same pump as 9910-D30 with 3/4" solid thru shaft					
9910-D30GRGI	9.6	36.3	580	40	3600	Assembled with gearbox 9910-KIT1640 and control 9910-GS40GI for mounting on 5 hp gas engine
9910-D30-B-GRGI	Same pump as 9910-D30GRGI with Buna-N diaphragms					
D30HRGI	9.6	36.3	580	40	3600	Assembled with gearbox 8000-0056 and control 9910-GS40GI for mounting on 5 hp gas engine

MEDIUM PRESSURE, 3 DIAPHRAGM

Model 9910-D403, and D403GRGI



FEATURES:

- ◆ Max. fluid temperature: 140°F/60°C
- ◆ Shaft: flanged for kit attachment (D403); 3/4" hollow shaft for gas engine mount (D403GRGI)
- ◆ Diaphragms: 3, semi-hydraulic, Desmopan® standard, Buna available
- ◆ Housing: anodized aluminum
- ◆ Mounting base: included
- ◆ For shaft kits and other drive options, see pages 91-92
- ◆ Recommended control unit: 9910-GR40, see page 93
- ◆ Weight: 23 lbs./10.4 kg (D403); 32 lbs./14.5 kg (D403GRGI)
- ◆ Gas engine versions on page 89

ORDER INFORMATION

Pressure in PSI and BAR	GPM	HP	GPM	HP	GPM	HP	GPM	HP	GPM	HP
	LPM	HP	LPM	HP	LPM	HP	LPM	HP	LPM	HP
	@350 RPM		@400 RPM		@450 RPM		@500 RPM		@550 RPM	
0 PSI	6.3	0.22	7.3	0.33	8.0	0.41	8.9	0.54	9.9	0.61
0 BAR	23.9	0.22	27.6	0.33	30.3	0.41	33.6	0.54	37.5	0.61
145 PSI	6.2	0.73	7.1	0.91	7.9	1.07	8.8	1.12	9.8	1.21
10 BAR	23.2	0.73	26.7	0.91	29.9	1.07	33.4	1.12	37.1	1.21
290 PSI	6.1	1.21	7.0	1.41	7.8	1.63	8.7	1.82	9.7	2.03
20 BAR	23.0	1.21	26.4	1.41	29.5	1.63	32.8	1.82	36.7	2.03
465 PSI	6.0	1.80	6.8	2.02	7.7	2.34	8.6	2.61	9.6	2.84
30 BAR	22.7	1.80	25.8	2.02	29.2	2.34	32.3	2.61	36.4	2.84
580 PSI	5.9	2.36	6.7	2.65	7.6	2.91	8.4	3.30	9.5	3.62
40 BAR	22.3	2.36	25.5	2.65	28.9	2.91	31.7	3.30	35.9	3.62

All HP requirements listed in the table are electrical. For approximate gasoline equivalent, multiply by 1.3.

Desmopan® is a registered trademark of Bayer Aktiengesellschaft, Farbenfabriken. Hypro® is a registered trademark of Pentair.

Model Number	Max GPM	Max LPM	Max PSI	Max BAR	Max RPM	Drive and Control Unit
9910-D403	9.9	37.5	580	40	550	1" HB inlet, 1/2" HB outlet
9910-D403GRGI	9.9	37.5	580	40	3600	Assembled with gearbox 9910-KIT1640 and control 9910-GR40 for mounting on 5-6 hp gas engines

MEDIUM PRESSURE, 2 DIAPHRAGM

Model 9910-D50, D50AP-A and D50-B



FEATURES:

- ◆ Max. fluid temperature: 140°F/60°C
- ◆ Shaft: flanged for shaft kit (D50); flange w/1" shaft ext. (D50AP-A)
- ◆ Diaphragms: 2, full-hydraulic, Desmopan® standard, Buna available (D50-B has Buna diaphragms)
- ◆ Housing components for liquid handling: epoxy coated
- ◆ Pump shaft rotation: CW and CCW
- ◆ For shaft kits and other drive options, see pages 91-92
- ◆ Recommended control unit: 9910-GS40GI, see page 93
- ◆ Weight: 35 lbs./15.9 kg

Pressure in PSI and BAR	GPM	HP	GPM	HP	GPM	HP	GPM	HP	GPM	HP
	LPM	HP	LPM	HP	LPM	HP	LPM	HP	LPM	HP
	@350 RPM		@400 RPM		@450 RPM		@500 RPM		@550 RPM	
0 PSI	9.7	0.36	11.9	0.49	12.3	0.64	13.2	0.77	14.8	0.94
0 BAR	36.8	0.36	45.0	0.49	46.6	0.64	49.9	0.77	55.8	0.94
145 PSI	9.3	1.08	11.5	1.25	11.9	1.49	12.9	1.59	14.6	1.76
10 BAR	35.1	1.08	43.3	1.25	44.9	1.49	48.6	1.59	55.1	1.76
290 PSI	9.1	1.85	11.0	2.09	11.7	2.40	12.6	2.72	14.5	2.97
20 BAR	34.4	1.85	41.5	2.09	44.1	2.40	47.4	2.72	54.9	2.97
465 PSI	8.8	2.61	10.8	3.00	11.6	3.41	12.0	3.80	14.4	4.03
30 BAR	33.2	2.61	40.6	3.00	43.6	3.41	45.3	3.80	54.4	4.03
580 PSI	8.6	3.44	10.3	3.77	11.4	4.38	11.9	4.92	14.1	5.17
40 BAR	32.5	3.44	38.9	3.77	42.9	4.38	44.7	4.92	53.3	5.17

All HP requirements listed in the table are electrical.
For approximate gasoline equivalent, multiply by 1.3.

ORDER INFORMATION

Model Number	Max GPM	Max LPM	Max PSI	Max BARI	Max RPM	Port Size
9910-D50	14.8	56.0	580	40	550	1-1/4" HB inlet, 1/2" HB outlet
9910-D50-B	Same pump as 9910-D50 w/Buna-N diaphragms					
9910-D50AP-A	Same pump as 9910-D50 w/solid 1" thru shaft					

MEDIUM PRESSURE, 3 DIAPHRAGM

Model 9910-D503, D503GRGI and D503GRGI34



FEATURES:

- ◆ Max. fluid temperature: 140°F/60°C
- ◆ Shaft: flanged adapter (D503); 1" hollow shaft for gas engine mount (D503GRGI)
- ◆ Diaphragms: 3, semi-hydraulic, Desmopan® standard, Buna available
- ◆ Housing: anodized aluminum
- ◆ Mounting base: included
- ◆ Pump shaft rotation: CW and CCW
- ◆ For shaft kits and other drive options, see pages 91-92
- ◆ Recommended control unit: 9910-RM40, see page 93
- ◆ Weight: 28 lbs./12.7 kg
- ◆ Gas engine versions on page 90

Pressure in PSI and BAR	GPM	HP	GPM	HP	GPM	HP	GPM	HP	GPM	HP
	LPM	HP	LPM	HP	LPM	HP	LPM	HP	LPM	HP
	@350 RPM		@400 RPM		@450 RPM		@500 RPM		@550 RPM	
0 PSI	9.4	0.52	12.1	0.86	12.6	0.91	13.4	1.09	14.3	1.32
0 BAR	35.4	0.52	45.5	0.86	47.6	0.91	50.5	1.09	54.1	1.32
145 PSI	9.0	1.24	11.6	1.68	11.9	1.72	13.2	1.85	14.1	2.09
10 BAR	34.1	1.24	44.0	1.68	44.9	1.72	49.7	1.85	53.3	2.09
290 PSI	8.9	2.05	11.4	2.67	11.7	2.74	12.8	3.01	13.8	3.30
20 BAR	33.6	2.05	43.2	2.67	44.1	2.74	48.4	3.01	51.9	3.30
465 PSI	8.7	2.78	11.3	3.72	11.6	3.90	12.6	4.14	13.6	4.41
30 BAR	33.0	2.78	42.5	3.72	43.6	3.90	47.4	4.14	51.4	4.41
580 PSI	8.5	3.56	11.0	4.67	11.4	4.83	12.2	5.37	13.4	5.49
40 BAR	32.2	3.56	41.7	4.67	42.9	4.83	46.0	5.37	50.5	5.49

All HP requirements listed in the table are electrical. For approximate gasoline equivalent, multiply by 1.3.
Desmopan® is a registered trademark of Bayer Aktiengesellschaft, Farbenfabriken. Hypro® is a registered trademark of Pentair.

ORDER INFORMATION

Model Number	Max GPM	Max LPM	Max PSI	Max BAR	Max RPM	Drive and Control Unit
9910-D503	14.3	54.1	580	40	550	-
9910-D503GRGI	14.3	54.1	580	40	3600	Assembled with gearbox 9910-KIT1642 and control 9910-RM40 for mounting on 8 hp gas engine
9910-D503GRGI34	14.3	54.1	290	20	3600	Assembled with gearbox 9910-KIT1640 and control 9910-RM40 for mounting on 5-6.5 hp gas engines

HIGH PRESSURE, 3 DIAPHRAGM

Model 9910-D813 and D813GRGI



FEATURES:

- ◆ Max. fluid temperature: 140°F/60°C
- ◆ Shaft: Flanged adapter and 1-3/8"- 6 splined male shaft ext. (D813); 1" hollow shaft for gas engine mount (D813GRGI)
- ◆ Diaphragms: 3, semi-hydraulic, Desmopan® standard Buna available
- ◆ Housing: anodized aluminum
- ◆ Mounting base: included
- ◆ Pump shaft rotation: CW and CCW
- ◆ For shaft kits and other drive options, see pages 91-92
- ◆ Recommended control unit: 9910-VDR50 or 9910-GS50GI, see page 93.
- ◆ Weight: 50 lbs./22.7 kg (D813); 66 lbs./30 kg (D813GRGI)

Pressure in PSI and BAR	GPM	HP	GPM	HP	GPM	HP	GPM	HP	GPM	HP
	LPM	HP	LPM	HP	LPM	HP	LPM	HP	LPM	HP
	@350 RPM		@400 RPM		@450 RPM		@500 RPM		@550 RPM	
0 PSI	14.7	0.41	17.0	0.64	18.2	0.74	19.8	0.93	20.8	1.12
0 BAR	55.6	0.41	64.3	0.64	68.7	0.74	74.7	0.93	78.6	1.12
217 PSI	13.9	2.23	16.1	2.51	17.8	2.93	19.5	3.40	19.9	3.61
15 BAR	52.3	2.23	60.8	2.51	67.1	2.93	73.7	3.40	75.0	3.61
435 PSI	13.6	4.06	15.6	4.65	17.4	5.26	19.1	5.80	19.7	6.23
30 BAR	51.2	4.06	58.7	4.65	65.5	5.26	71.9	5.80	74.3	6.23
580 PSI	13.5	5.22	15.3	6.03	17.2	6.81	18.4	7.51	19.2	8.01
40 BAR	50.8	5.22	57.7	6.03	64.8	6.81	69.4	7.51	72.6	8.01
725 PSI	13.4	6.30	15.0	7.31	16.9	8.33	17.9	9.23	19.0	9.82
50 BAR	50.4	6.30	56.5	7.31	63.9	8.33	67.5	9.23	71.8	9.82

All HP requirements listed in the table are electrical. For approximate gasoline equivalent, multiply by 1.3.

ORDER INFORMATION

Model Number	Max GPM	Max LPM	Max PSI	Max BAR	Max RPM	Port Size	Shaft Output
9910-D813	20.8	78.7	725	50	550	1-1/4" HB inlet, 3/4" NPT outlet	1-3/8"- 6 splined male shaft extension
9910-D813GRGI	20.8	78.7	725	50	3600	Assembled with gearbox 9910-KIT1642 and control 9910-VDR50 for mounting on 13 hp gas engine	

HIGH PRESSURE, 4 DIAPHRAGM

Model 9910-D1064 and D1064GRGI



FEATURES:

- ◆ Max. fluid temperature: 140°F/60°C
- ◆ Shaft: Flanged adapter and 1-3/8"- 6 splined male shaft ext. (D1064); 1" hollow shaft for gas engine mount (D1064GRGI)
- ◆ Diaphragms: 4, semi-hydraulic, Desmopan® standard, Buna available
- ◆ Housing: anodized aluminum
- ◆ Mounting base: included
- ◆ Pump shaft rotation: CW and CCW
- ◆ For shaft kits and other drive options, see pages 91-92
- ◆ Recommended control unit: 9910-VDR50 or 9910-GS50GI, see page 93
- ◆ Weight: 54 lbs./24.5 kg (D1064); 76 lbs./34.5 kg (D1064GRGI)

Pressure in PSI and BAR	GPM	HP	GPM	HP	GPM	HP	GPM	HP	GPM	HP
	LPM	HP	LPM	HP	LPM	HP	LPM	HP	LPM	HP
	@350 RPM		@400 RPM		@450 RPM		@500 RPM		@550 RPM	
0 PSI	19.6	0.75	22.4	1.04	25.2	1.33	27.1	1.59	28.7	1.90
0 BAR	74.0	0.75	84.6	1.04	95.1	1.33	102.4	1.59	108.5	1.90
217 PSI	18.8	2.95	21.6	3.41	24.5	3.92	26.8	4.33	28.5	4.71
15 BAR	70.8	2.95	81.6	3.41	92.3	3.92	101.1	4.33	107.6	4.71
435 PSI	18.4	5.40	21.1	6.20	23.9	7.01	26.2	7.77	28.3	8.28
30 BAR	69.4	5.40	79.5	6.20	90.3	7.01	98.8	7.77	106.7	8.28
580 PSI	18.2	7.01	21.0	8.05	23.7	9.12	26.0	10.06	28.0	10.79
40 BAR	68.8	7.01	79.2	8.05	89.3	9.12	98.1	10.06	105.8	10.79
725 PSI	18.0	8.65	20.8	9.88	23.3	11.18	25.9	12.38	27.8	13.13
50 BAR	67.9	8.65	78.4	9.88	87.9	11.18	97.6	12.38	104.7	13.13

All HP requirements listed in the table are electrical. For approximate gasoline equivalent, multiply by 1.3. Desmopan® is a registered trademark of Bayer Aktiengesellschaft, Farbenfabriken. Hypro® is a registered trademark of Pentair.

ORDER INFORMATION

Model Number	Max GPM	Max LPM	Max PSI	Max BAR	Max RPM	Port Size	Shaft Output
9910-D1064	28.7	108.6	725	50	550	1-1/4" HB inlet, 3/4" NPT outlet	1-3/8"- 6 splined male shaft extension
9910-D1064GRGI	28.7	108.6	725	50	3600	Assembled with gearbox 9910-KIT1642 and control 9910-VDR50 for mounting on 18 hp gas engine	

HIGH PRESSURE, 3 DIAPHRAGM

Model 9910-DBS110 and DBA110



FEATURES:

- ◆ Max fluid temp: 140°F/60°C
- ◆ Diaphragms: 3, semi-hydraulic, Buna standard
- ◆ Housing components for liquid handling:
 - DBS - external bronze manifolds and brass heads
 - DBA - external manifolds and heads in anodized aluminum
- ◆ Pump shaft rotation: CW and CCW
- ◆ Recommended control unit: 9910-BMH50 or 9910-GH50, see page 93.
- ◆ Weight: 114 lbs./51.7 kg (DBS110); 88 lbs./40 kg (DBA110)

Pressure in PSI and BAR	GPM	HP	GPM	HP	GPM	HP	GPM	HP	GPM	HP
	LPM	HP	LPM	HP	LPM	HP	LPM	HP	LPM	HP
	@350 RPM		@400 RPM		@450 RPM		@500 RPM		@550 RPM	
0 PSI	19.2	0.53	21.9	0.60	24.6	0.78	27.3	0.89	30.0	1.12
0 BAR	72.6	0.53	82.8	0.60	93.0	0.78	103.2	0.89	113.1	1.12
217 PSI	18.7	2.91	21.5	3.18	24.2	3.74	27.1	4.02	29.3	4.50
15 BAR	70.7	2.91	81.2	3.18	91.4	3.74	102.1	4.02	110.6	4.50
435 PSI	18.5	5.19	21.2	5.91	24.0	6.51	26.9	7.51	29.0	8.29
30 BAR	69.9	5.19	79.9	5.91	90.7	6.51	101.4	7.51	109.4	8.29
580 PSI	18.4	6.87	20.9	7.66	23.7	8.69	26.4	9.67	28.7	10.71
40 BAR	69.5	6.87	78.9	7.66	89.3	8.69	99.8	9.67	108.2	10.71
725 PSI	18.2	8.43	20.8	9.60	23.5	10.73	25.9	11.90	28.6	13.11
50 BAR	68.7	8.43	78.5	9.60	88.5	10.73	97.7	11.90	108.0	13.11

ORDER INFORMATION

Model Number	Max GPM	Max LPM	Max PSI	Max BAR	Max RPM	Port Size	Shaft Output
9910-DBS110	30.0	113.6	725	50	550	1-1/2" HB inlet, 3/4" NPT outlet	1-3/8"- 6 splined male double-ended shaft
9910-DBA110	30.0	113.6	725	50	550	1-1/2" HB inlet, 3/4" NPT outlet	1-3/8"- 6 splined male double-ended shaft

All HP requirements listed in the table are electrical. For approximate gasoline equivalent, multiply by 1.3.
Desmopan® is a registered trademark of Bayer Aktiengesellschaft, Farbenfabriken.
Hypro® is a registered trademark of Pentair.

HIGH PRESSURE, 3 DIAPHRAGM

Model 9910-DBS140 and DBA140



FEATURES:

- ◆ Max fluid temp: 140°F/60°C
- ◆ Diaphragms: 3, semi-hydraulic, Buna standard
- ◆ Housing components for liquid handling:
 - DBS - external bronze manifolds and brass heads
 - DBA - external manifolds and heads in anodized aluminum
- ◆ Weight: 114 lbs./51.7 kg (DBS140); 88 lbs./40 kg (DBA140)
- ◆ Pump shaft rotation: CW and CCW
- ◆ Recommended control unit: 9910-BMH50 or 9910-GH50, see page 93 .
- ◆ Weight: 114 lbs./51.7 kg (DBS140); 88 lbs./40 kg (DBA140)

Pressure in PSI and BAR	GPM	HP	GPM	HP	GPM	HP	GPM	HP	GPM	HP
	LPM	HP	LPM	HP	LPM	HP	LPM	HP	LPM	HP
	@350 RPM		@400 RPM		@450 RPM		@500 RPM		@550 RPM	
0 PSI	25.1	0.82	28.5	1.11	31.5	1.50	34.8	2.02	37.8	2.58
0 BAR	94.6	0.82	107.5	1.11	119.0	1.50	131.5	2.02	142.6	2.58
217 PSI	24.1	3.47	27.5	4.01	30.7	4.51	33.2	5.01	37.3	5.61
15 BAR	91.1	3.47	103.8	4.01	115.9	4.51	125.3	5.01	140.9	5.61
435 PSI	23.8	6.53	27.2	7.69	30.2	8.39	32.6	9.28	36.7	10.34
30 BAR	89.9	6.53	102.8	7.69	114.1	8.39	123.1	9.28	138.7	10.34
580 PSI	23.6	8.53	26.8	9.73	29.8	10.82	32.2	12.02	36.5	13.33
40 BAR	89.1	8.53	101.0	9.73	112.6	10.82	121.5	12.02	137.6	13.33
725 PSI	23.3	10.47	26.5	11.88	29.7	13.28	31.9	14.67	36.3	16.28
50 BAR	88.1	10.47	100.0	11.88	112.2	13.28	120.4	14.67	137.0	16.28

ORDER INFORMATION

Model Number	Max GPM	Max LPM	Max PSI	Max BAR	Max RPM	Port Size	Shaft Output
9910-DBS140	37.8	143.1	725	50	550	1-1/2" HB inlet, 3/4" NPT outlet	1-3/8"- 6 splined male double-ended shaft
9910-DBA140	37.8	143.1	725	50	550	1-1/2" HB inlet, 3/4" NPT outlet	1-3/8"- 6 splined male double-ended shaft

All HP requirements listed in the table are electrical.
For approximate gasoline equivalent, multiply by 1.3.

HIGH PRESSURE, 4 DIAPHRAGM

Model 9910-DBS160 and DBA160



FEATURES:

- ◆ Max fluid temp: 140°F/60°C
- ◆ Diaphragms: 4, semi-hydraulic, Buna standard
- ◆ Housing components for liquid handling:
 - DBS - external bronze manifolds and brass heads
 - DBA - external manifolds and heads in anodized aluminum
- ◆ Pump shaft rotation: CW and CCW
- ◆ Recommended control unit: 9910-BMH50 or 9910-GH50, see page 93.
- ◆ Weight: 143 lbs./64.9 kg (DBS160); 112 lbs./50.9 kg (DBA160)

Pressure in PSI and BAR	GPM		HP		GPM		HP		GPM		HP	
	LPM	HP	LPM	HP	LPM	HP	LPM	HP	LPM	HP	LPM	HP
	@350 RPM		@400 RPM		@450 RPM		@500 RPM		@550 RPM			
0 PSI	25.5	1.12	29.3	1.52	32.6	1.83	36.1	2.23	39.6	2.82		
0 BAR	96.3	1.12	110.4	1.52	122.9	1.83	136.3	2.23	149.4	2.82		
217 PSI	24.9	3.72	28.7	4.39	32.1	4.83	35.7	5.27	39.1	5.91		
15 BAR	94.1	3.72	108.4	4.39	121.3	4.83	134.8	5.27	147.5	5.91		
435 PSI	24.6	6.90	28.3	8.01	31.9	8.89	35.3	9.80	38.5	10.75		
30 BAR	93.0	6.90	106.6	8.01	120.5	8.89	133.4	9.80	145.3	10.75		
580 PSI	24.5	8.88	28.1	10.22	31.5	11.49	35.0	12.77	38.4	14.12		
40 BAR	92.4	8.88	106.1	10.22	118.9	11.49	132.2	12.77	144.9	14.12		
725 PSI	24.2	10.91	27.9	12.46	31.3	14.01	34.8	15.64	38.2	17.28		
50 BAR	91.4	10.91	105.3	12.46	118.2	14.01	131.5	15.64	144.2	17.28		

All HP requirements listed in the table are electrical. For approximate gasoline equivalent, multiply by 1.3.

ORDER INFORMATION

Model Number	Max GPM	Max LPM	Max PSI	Max BAR	Max RPM	Port Size	Shaft Output
9910-DBS160	39.6	149.9	725	50	550	1-1/2" HB inlet, 3/4" NPT outlet	1-3/8"- 6 splined male double- ended shaft
9910-DBA160	39.6	149.9	725	50	550	1-1/2" HB inlet, 3/4" NPT outlet	1-3/8"- 6 splined male double- ended shaft

HIGH PRESSURE, 4 DIAPHRAGM

Model 9910-DBS200 and DBA200



FEATURES:

- ◆ Max fluid temp: 140°F/60°C
- ◆ Diaphragms: 4, semi-hydraulic, Buna standard
- ◆ Housing components for liquid handling:
 - DBS - external bronze manifolds and brass heads
 - DBA - external manifolds and heads in anodized aluminum
- ◆ Pump shaft rotation: CW and CCW
- ◆ Recommended control unit: 9910-GH50, see page 93.
- ◆ Weight: 143 lbs./64.9 kg (DBS200); 112 lbs./50.9 kg (DBA200)

Pressure in PSI and BAR	GPM		HP		GPM		HP		GPM		HP	
	LPM	HP	LPM	HP	LPM	HP	LPM	HP	LPM	HP	LPM	HP
	@350 RPM		@400 RPM		@450 RPM		@500 RPM		@550 RPM			
0 PSI	33.0	1.44	37.3	1.92	41.6	2.74	45.9	3.03	49.7	3.67		
0 BAR	124.5	1.44	140.7	1.92	156.9	2.74	173.1	3.03	187.6	3.67		
217 PSI	32.0	4.68	36.7	5.38	41.0	6.13	45.3	6.91	49.1	7.64		
15 BAR	120.8	4.68	138.5	5.38	154.8	6.13	170.8	6.91	185.4	7.64		
435 PSI	31.4	8.79	36.1	10.24	40.4	11.44	44.8	12.71	48.7	13.92		
30 BAR	118.4	8.79	136.2	10.24	152.6	11.44	169.0	12.71	183.9	13.92		
580 PSI	31.3	11.35	35.8	13.01	40.0	14.69	44.6	16.45	48.3	17.98		
40 BAR	118.2	11.35	135.0	13.01	151.1	14.69	168.3	16.45	182.5	17.98		
725 PSI	31.1	14.01	35.3	15.96	39.9	18.12	44.4	20.21	48.2	22.21		
50 BAR	117.2	14.01	133.1	15.96	150.5	18.12	167.5	20.21	182.1	22.21		

All HP requirements listed in the table are electrical.
For approximate gasoline equivalent, multiply by 1.3.

ORDER INFORMATION

Model Number	Max GPM	Max LPM	Max PSI	Max BAR	Max RPM	Port Size	Shaft Output
9910-DBS200	49.7	188.1	725	50	550	1-1/2" HB inlet, 3/4" NPT outlet	1-3/8"- 6 splined male double-ended shaft
9910-DBA200	49.7	188.1	725	50	550	1-1/2" HB inlet, 3/4" NPT outlet	1-3/8"- 6 splined male double-ended shaft

GAS ENGINE-DRIVEN, MEDIUM PRESSURE, 2 DIAPHRAGM

Models: D252GRGI-25, D252GRGI-55, 1534



FEATURES:

- ◆ Closed-coupled, gas engine driven (EPA & CARB certified)
- ◆ Max. fluid temperature: 140°F/60°C
- ◆ Diaphragms: 2, semi-hydraulic, Desmopan® standard, Buna available
- ◆ Housing: anodized aluminum
- ◆ Mounting base: included

ORDER INFORMATION

Pressure in PSI and BAR	GPM
BAR	LPM
0 PSI	5.9
0 BAR	22.3
50 PSI	5.3
3.4 BAR	20.0
100 PSI	5.2
6.9 BAR	19.5
150 PSI	5.1
10.3 BAR	19.3
200 PSI	5.0
13.6 BAR	18.9
250 PSI	4.9
17.0 BAR	18.5
290 PSI	4.9
20 BAR	18.5

Model Number	Max GPM	Max LPM	Max PSI	Max BAR	Max RPM	Control Unit and Gearbox	Engine Mfgr. and hp
D252GRGI-25	5.9	22.3	290	20	3600	9910-KIT1990	PowerPro 2.5 hp
D252GRGI-55	5.9	22.3	290	20	2800	9910-KIT1990	PowerPro 6.5 hp
D252GRGI-120H	5.9	22.3	290	20	2800	9910-KIT1990	Honda GX120 Engine

Desmopan® is a registered trademark of Bayer Aktiengesellschaft, Farbenfabriken. Hypro® is a registered trademark of Pentair.

GAS ENGINE-DRIVEN, MEDIUM PRESSURE, 2 DIAPHRAGM

Model: D30HRGI-65, D30HRGI-65E, D30GRGI-65, D30HRGI-160H, 1535, D30HRGI



FEATURES:

- ◆ Closed-coupled, gas engine driven (EPA & CARB certified)
- ◆ Max. fluid temperature: 140°F/60°C
- ◆ Diaphragms: 2, semi-hydraulic, Desmopan® standard, Buna available
- ◆ Housing components for liquid handling: epoxy-coated

ORDER INFORMATION

Pressure in PSI and BAR	D30HRGI-65,65E	D30GRGI-65,1535
	GPM	GPM
	LPM	LPM
	@550 RPM	@550 RPM
0 PSI	9.6	9.3
0 BAR	36	35
290 PSI	8.8	9.3
20 BAR	33	34
435 PSI	8.6	8.7
30 BAR	33	33
580 PSI	8.3	8.2
40 BAR	31	31

Model Number	Max GPM	Max LPM	Max PSI	Max BAR	Max RPM	Control Unit and Gearbox	Engine Mfgr. and hp
D30HRGI-65	9.6	36.3	580	40	3600	GS40GI and 8000-0056	PowerPro 6.5 HP
D30HRGI-65E	9.6	36.3	580	40	3600	GS40GI and 8000-0056	PowerPro 6.5 HP w/ electric start
D30GRGI-65	9.6	36.3	580	40	3600	GS40GI and KIT1640 (gearbox)	PowerPro 6.5 hp
D30GRGI-160H	9.6	36.3	580	40	3600	GS40GI and KIT1640 (gearbox)	Honda GX160
D30GRGI-160EH	9.6	36.3	580	40	3600	GS40GI and KIT1640 (gearbox)	Honda GX160 w/electric start
D30HRGI-160H	9.6	36.3	580	40	3600	GS40GI and 8000-0056	Honda GX160
D30HRGI-160EH	9.6	36.3	580	40	3600	GS40GI and KIT1640 (gearbox)	Honda GX160 w/electric start
D30HRGI	9.3	35.2	580	40	3600	GS40GI and KIT1640 (gearbox)	Less engine

GAS ENGINE-DRIVEN, MEDIUM PRESSURE, 3 DIAPHRAGM

Model: D403HRGI-65, D403HRGI-65E, D403GRGI-65, D403HRGI



FEATURES:

- ◆ Closed-coupled, gas engine driven (EPA & CARB certified)
- ◆ Max. fluid temperature: 140°F/60°C
- ◆ Diaphragms: 3, semi-hydraulic, Desmopan® standard, Buna available
- ◆ Housing: anodized aluminum
- ◆ Mounting base: included

ORDER INFORMATION

Pressure in PSI and BAR	D403HRGI-65,65E	D403GRGI-65
	GPM	GPM
	LPM	LPM
	@550 RPM	@550 RPM
0 PSI	9.9	10.6
0 BAR	38	40
290 PSI	9.7	9.8
20 BAR	37	37
435 PSI	9.6	9.7
30 BAR	36	37
580 PSI	9.5	9.5
40 BAR	36	36

Model Number	Max GPM	Max IPM	Max PSI	Max BAR	Max RPM	Control Unit and Gearbox	Engine Mfgr. and hp
D403HRGI-65	9.9	37.5	580	40	3600	GR40 and 8000-0056	PowerPro 6.5 HP
D403HRGI-65E	9.9	37.5	580	40	3600	GR40 and 8000-0056	PowerPro 6.5 HP w/ electric start
D403GRGI-65	10.6	40.1	580	40	3600	GR40 and KIT1640 (gearbox)	PowerPro 6.5 hp
D403HRGI	9.9	37.5	580	40	3600	GR40 and 8000-0056	Less engine

GAS ENGINE-DRIVEN, HEAVY-DUTY MEDIUM PRESSURE, 3 DIAPHRAGM

Model: D50GRGI-160H, D50GRGI-160EH



FEATURES:

- ◆ Hypro quality diaphragm pumps powered by field-proven PowerPro certified engines (EPA & CARB certified)
- ◆ Oil-bath design and premium quality synthetic diaphragms provides longer life and greater reliability
- ◆ Oil-bath design also allows pump to be run dry
- ◆ Self-priming operation
- ◆ Corrosive, abrasive and general use chemical compatibility
- ◆ Visual oil-level sight glass
- ◆ Supported with a one-year Hypro warranty on both pump and PowerPro engine
- ◆ Diaphragms: 3, semi-hydraulic, Desmopan® standard, Buna available

ORDER INFORMATION

Pressure in PSI and BAR	GPM	HP
	LPM	HP
	@550 RPM	
0 PSI	14.8	0.94
0 BAR	55.8	0.94
145 PSI	14.6	1.76
10 BAR	55.1	1.76
290 PSI	14.5	2.97
20 BAR	54.9	2.97
465 PSI	14.4	4.03
30 BAR	54.4	4.03
580 PSI	14.1	5.17
40 BAR	53.3	5.17

Model Number	Max GPM	Max GPM	Max PSI	Max BAR	Max RPM	Control Unit & Gearbox	Engine Mfgr. & HP
D50GRGI-160H	14.1	53.3	580	40	3600	9910-GS40GI and 9910-Kit1640	Honda GX160
D50GRGI-160EH	14.1	53.3	580	40	3600	9910-GS40GI and 9910-Kit1640	Honda GX160 w./electric start

Desmopan® is a registered trademark of Bayer Aktiengesellschaft, Farbenfabriken. Hypro® is a registered trademark of Pentair.

GAS ENGINE-DRIVEN, HEAVY-DUTY MEDIUM PRESSURE, 3 DIAPHRAGM

Model: D503HRGI-65, D503HRGI



FEATURES:

- ◆ Hypro quality diaphragm pumps powered by field-proven PowerPro certified engines (EPA & CARB certified)
- ◆ Oil-bath design and premium quality synthetic diaphragms provides longer life and greater reliability
- ◆ Oil-bath design also allows pump to be run dry
- ◆ Self-priming operation
- ◆ Corrosive, abrasive and general use chemical compatibility
- ◆ Visual oil-level sight glass
- ◆ Supported with a one-year Hypro warranty on both pump and PowerPro engine
- ◆ Diaphragms: 3, semi-hydraulic, Desmopan® standard, Buna available

ORDER INFORMATION

Pressure in PSI and BAR	D503HRGI-65.65E
	GPM
	LPM
	@550 RPM
0 PSI	14.3
0 BAR	54
145 PSI	14.1
10 BAR	53
290 PSI	13.8
20 BAR	52

Model Number	Max GPM	Max GPM	Max PSI	Max BAR	Max RPM	Control Unit & Gearbox	Engine Mfgr. & HP
D503HRGI-65	14.3	54.1	290	20	3600	RM40 and 8000-0056	PowerPro 6.5 HP
D503HRGI-65E	14.3	54.1	290	20	3600	RM40 and 8000-0056	PowerPro 6.5 HP w/ electric start
D503HRGI	14.3	54.1	290	20	3600	RM40 and 8000-0056	Less engine

DIAPHRAGM KITS AND APPLICATIONS



HYPRO PUMP OIL

Part Number	Description	Weight	
		US Units	Metric
2160-0038	1 quart of specially-formulated pump oil	2 lbs.	907 g
2160-0047	1 gallon of specially-formulated pump oil	9 lbs.	4.1 kg
2160-0048	2 ½ gallons of specially-formulated pump oil	22 lbs.	9.98 kg

All Hypro Plunger Pumps are shipped with oil. To optimize pump life, Hypro recommends an oil change after 40 hours of break-in operation and every three months or 500 hour intervals thereafter. Use only Hypro oil.



1-3/8"-6 SPLINE FEMALE PTO SHAFT KITS

Kit Number	Description	Weight	
		US Units	Metric
9910-KIT1704	For Model 9910-D50, D30, D303 and D403 pumps	7 lbs.	3.2 kg
9910-KIT1708	For Model 9910-D70 and D115 pumps	5.25 lbs.	2.4 kg
9910-KIT2204	For Model 9910-D503, D813, D1064 and D1265 pumps	7 lbs.	3.2 kg

Kit includes a female PTO coupler and retaining clamp, torque arm and mounting bracket, chains and necessary hardware.



1-3/8"-6 SPLINE MALE PTO SHAFT KITS

Kit Number	Description	Weight	
		US Units	Metric
9910-KIT1702	For Model 9910-D30 pump	3 lbs.	1.4 kg
9910-KIT1706	For Model 9910-D50 pump	4.25 lbs.	1.9 kg
*9910-KIT1710	For Model 9910-D70 and D115 pumps	5.5 lbs.	2.5 kg
9910-KIT2200	For Model 9910-D503, D303 and D403 pumps	4.25 lbs.	1.9 kg
9910-KIT2201	For Model 9910-D813, D1064 and D1265 pumps	4.25 lbs.	1.9 kg

*Kit includes a male PTO shaft adapter, mounting bracket and necessary hardware.



1" SOLID SHAFT KITS

Kit Number	Description	Weight	
		US Units	Metric
9910-KIT1703	For Model 9910-D30 pump	2.5 lbs.	1.7 kg
9910-KIT1707	For Model 9910-D50 pump	3.75 lbs.	1.7 kg
*9910-KIT1711	For Model 9910-D70 and D115 pumps	5 lbs.	2.3 kg
9910-KIT2202	For Model 9910-D503, D303 and D403 pumps	3.75 lbs.	1.7 kg
9910-KIT2203	For Model 9910-D813, D1064 and D1265 pumps	3.75 lbs.	1.7 kg

*Kit includes a male PTO shaft adapter, mounting bracket and necessary hardware.

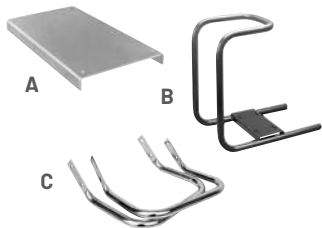

BASE PLATES AND CARRYING HANDLES

Part Number	Description	Ref.	Est. Weight Ea.	
			US Units	Metric
1510-0002	9 1/2" x 18" with 10 gauge	A	8 lbs.	3.6 kg
1510-0001	12" x 21" with 7 gauge	A	16 lbs.	7.3 kg
1510-0016	14" x 26" with 7 gauge	A	21 lbs.	9.5 kg
1510-0075	9-1/2" x 4-1/2" with 14 gauge (for 3 and 5 hp Briggs* or Honda* and 56 frame electric)	B	11 lbs.	5 kg
2801-0001	Two handles, mounting bolts and nuts for #1510-0016 base	C	3 lbs. 4 oz.	1.5 kg
2801-0002	Two handles, mounting bolts and nuts for #1510-0001 base	C	3 lbs. 3 oz.	1.4 kg

DIAPHRAGM PUMP REPAIR KITS

For Pump Model	Diaphragm Kit (Desmopan)	Diaphragm Kit (Buna-N)	Valve Kit	O-ring Kit
9910-D70	9910-KIT1720	-----	9910-KIT2364	9910-KIT2365
9910-D115 and D135	9910-KIT1721	-----	9910-KIT2370	9910-KIT2026
9910-D160	9910-KIT1730	-----	9910-KIT2374	9910-KIT1908
9910-D250	9910-KIT1722	-----	9910-KIT2114	9910-KIT1904
9910-D12GRGI	9910-KIT1882	-----	9910-KIT1992	
9910-D503	9910-KIT1881	-----	9910-KIT1987	9910-KIT1984
9910-D252 (all versions)	9910-KIT1723	-----	9910-KIT2408	9910-KIT2409
9910-D30 (all versions)	9910-KIT1724	9910-KIT2110	9910-KIT1917	9910-KIT1916
9910-D50	9910-KIT1725	9910-KIT2111	9910-KIT1920	9910-KIT1919
9910-DBS110, DBS140, DBA110 and DBA140	-----	9910-KIT2444	9910-KIT2445	9910-KIT2446
9910-DBS160, DBS200, DBA160 and DBA200	-----	9910-KIT2456	9910-KIT2374	9910-KIT2457
9910-D303	9910-KIT2423	-----	9910-KIT2388	9910-KIT2389
9910-D403	9910-KIT2423	-----	9910-KIT2388	9910-KIT2389
9910-D813	9910-KIT2479	-----	9910-KIT1963	9910-KIT2376
9910-D1064	9910-KIT2480	-----	9910-KIT1964	9910-KIT2378
9910-D1265	9910-KIT2100	-----	9910-KIT2024	9910-KIT2347
9910-D1554	9910-KIT1734	-----	9910-KIT1965	9910-KIT1972
9910-D1516	9910-KIT2113	-----	9910-KIT2053	9910-KIT2349

Honda* is a registered trademark of Honda Motor Co., Ltd.
 Briggs & Stratton* is a registered trademark of Briggs & Stratton Corporation.
 Hypro* is a registered trademark of Pentair Ltd.

PUMP AND GEAR REDUCTION KITS



MODEL 9910-KIT1640

- ◆ For Pump Models 9910-D30, D303 and D403
- ◆ 6:1 gear box
- ◆ For standard 5.5 hp gas engine with 3/4" shaft
- ◆ Can be used with 9910-D50, D503 and D813, providing that pumps are operated at lower pressures that do not exceed 5 hp gas engine compatibility.
- ◆ Weight: 6.5 lbs./2.9 kg



MODEL 9910-KIT1642

- ◆ For Pump Models 9910-D50, D503, D813, D1064 and D1265
- ◆ 6:1 gear box
- ◆ For standard 8-18 hp gas engine with 1" shaft
- ◆ Weight: 8.5 lbs./3.9 kg



MODEL 8000-0056

- ◆ For Pump Models 9910-D30, D403, D50, and D503
- ◆ New and improved bolt-through pinion gear to help prevent keyway fretting and seizing
- ◆ Engine mounting flange designed for ease of assembly with standard tools
- ◆ Robust 6:1 gear design for increases longevity
- ◆ Increased oil capacity
- ◆ Made for use on gas engines with 3/4" shaft
- ◆ Available pre-assembled on HRGI models

HYDRAULIC FLANGE KITS



MODEL 9910-HYD5312

- ◆ Fits Diaphragm Pump Models 9910-D30, D50, D303, D403, D503, D813, D1064 and D1265
- ◆ Includes: one flange with SAE "A" 2 bolt, one 1" hollow shaft and two bolts



MODEL 9910-HYD1570

- ◆ Fits Diaphragm Pump Models 9910-D160 and D250
- ◆ Includes: one flange with SAE "A" 2 bolt, one 1" coupling and hardware for mounting



MODEL 9910-HYD2495

- ◆ Fits Diaphragm Pump Models 9910-D70, D115
- ◆ Includes: one flange with SAE "A" 2 bolt, one 1" coupling, two pins, spacer and hardware for mounting



MODEL 9910-KIT55375

- ◆ Fits Diaphragm Pump Models 9910-DP423, DP573 & DP763
- ◆ Includes: one flange with SAE "A" 2 bolt, one 1" coupling and hardware for mounting

DIAPHRAGM CONTROL UNITS

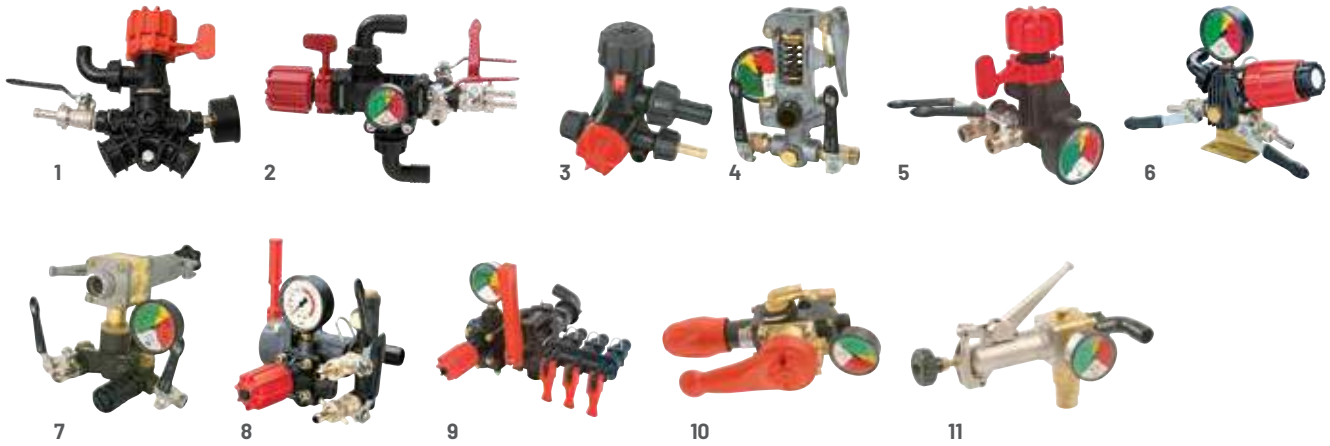

Ref #	Model	For Pump Model	Includes	Max Flow	Max Pressure	Weight
1	9910-GS25	9910-DP423	Pressure gauge, adjustable high pressure relief valve, 1/2" HB outlet with ball valve shutoff, bypass lever, 3/4" HB bypass, 1" HB inlet	11 gpm (42 lpm)	290 psi (20 bar)	2 lbs. (0.9 kg)
2	9910-GS35S	9910-DP573 & 9910-DP763	Pressure gauge, adjustable high pressure relief valve, two 1/2" HB outlet with ball valve shutoff, bypass lever, 3/4" HB bypass, 1" HB inlet	24 gpm (90.8 lpm)	290 psi (20 bar)	3 lbs. (1.4 kg)
3	9910-KIT1990	9910-D252	One adjustable relief valve, one pressure/bypass selector, 5/8" HB bypass port and 3/8" HB outlet	6 gpm (22.7 lpm)	290 psi (20 bar)	1 lb. (0.5 kg)
4	9910-GS40GI	9910-D30 & 9910-D50	Pressure gauge, one adjustable high pressure relief valve, one complete bypass lever, two 1/2" HB outlets with individual shut-offs, and 3/4" hose barb bypass; Remote mounting kit: 9910-KIT1741	21 gpm (79.5 lpm)	580 psi (40 bar)	3.5 lbs. (1.6 kg)
5	9910-GR40	9910-D303 & 9910-D403	Pressure gauge, adjustable high pressure relief valve, complete bypass lever, 2-1/2" pressure gauge, two 1/2" hose barb outlets with individual shut-offs, and 5/8" hose barb bypass; Remote mounting kit: 9910-KIT1741	11 gpm (42 lpm)	580 psi (40 bar)	2 lbs. (0.9 kg)
6	9910-RM40	9910-D503	Pressure gauge, one adjustable high pressure relief valve, one complete bypass knob, two 1/2" HB outlets with individual shut-offs, and 1" hose barb bypass; Remote mounting kit: 9910-KIT1897 (Includes: mounting bracket, bolts, and hose barb)	24 gpm (90.8 lpm)	580 psi (40.0 bar)	3.5 lbs. (1.6 kg)
7	9910-GS50GI (Remote mounting only)	9910-D813, 9910-D1064, 9910-D1265 & 9910-D1516	Pressure gauge, one adjustable high pressure relief valve, one complete bypass lever, three 1/2" HB outlets with individual shut-offs, and 1" hose barb bypass; Remote mounting kit: 9910-Kit1742 required. (Includes: mounting bracket, bolts, and hose barb)	48 gpm (181.7 lpm)	725 psi (50 bar)	8.5 lbs. (3.6 kg)
8	9910-VDR50	9910-D813, 9910-D1064 & 9910-D1265	Pressure gauge, one adjustable high pressure relief valve, one complete bypass lever, two 1/2" HB outlets with individual shut-offs, and 1" hose barb bypass; For additional ball valve, order Part Number 9910-130491	35 gpm (132.5 lpm)	725 psi (50 bar)	3.5 lbs. (1.6 kg)
9	3300-0087	9910-D70, 9910-D115, 9910-D135 & 9910-D160	One built-in relief valve, one 1" HB inlet, three 3/4", 1/2" and 3/8" HB outlets with individual shut-offs; Model-0088 includes a main bypass lever	42.5 gpm (160.9 lpm)	290 psi (20 bar)	7 lbs. (3.2 kg)
	3300-0088					7.75 lbs. (3.5 kg)
10	9910-BMH50	9910-DBS110, 9910-DBA110, 9910-DBS140, 9910-DBA140, 9910-DBS160, 9910-DBA160, 9910-DBS200, & 9910-DBA200	Directional control unit with working pressure regulating valve, single lever for partial or total closure and discharge and glycerine-bath pressure gauge with colored dial	41 gpm (155.2 lpm)	725 psi (50 bar)	6.6 lbs. (3.0 kg)
11	9910-GH50		Working pressure regulating valve, bypass control lever and glycerine-bath pressure gauge with colored dial	52.8 gpm (200 lpm)	725 psi (50 bar)	8.25 lbs. (3.7 kg)

DEMAND VS BYPASS PUMP

DEMAND PUMP

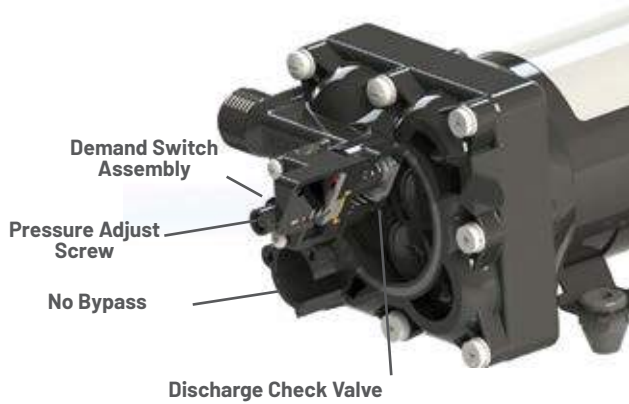

BYPASS PUMP

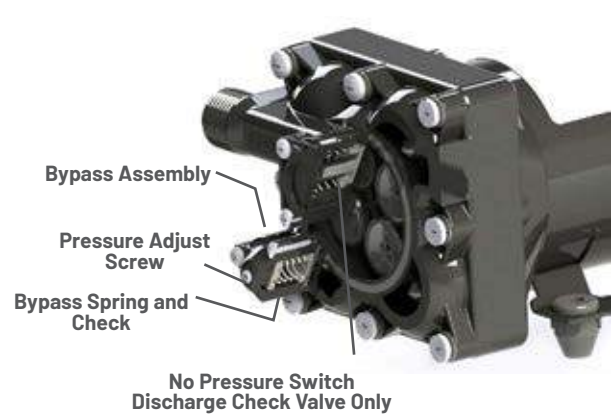

COMMON USES

Applications with a set flow and pressure requirement.
Example: Spray wands on spot sprayers.

HOW IT WORKS

When the operator shuts off the wand, pressure in the line increases to a set point and the pressure switch shuts off the motor. A check valve inside the pump keeps trapped pressure in the line. When the wand is turned back on, pressure in the line decreases. The pressure falls below the set point then restarts the pump

SIZING THE PUMP

Select a pump with a pressure and flow point that is matched to the orifice size in the wand

PRO

- ◆ Saves wear and tear on the pump
- ◆ Extends the service life of the battery

CON

- ◆ Can be difficult to use with variable rate
- ◆ Hand operated spray wands and guns

COMMON USES

Applications where a wide range of flows and pressures may be required. Examples: Spray bar with multiple nozzles, all controlled independently.

HOW IT WORKS

The pump continues to run regardless of pressure in the system. For the spray bar example, the flow rate is different when one nozzle is turned on as opposed to having two or more turned on. As nozzles are turned off, excess flow is bypassed within the pump.

SIZING THE PUMP

Size the pump for the maximum flow rate required with all nozzles spraying

PRO

- ◆ Prevents on/off cycling of pump which can lead to early failure

CON

- ◆ If discharge valve is closed for too long, overheating and damage can occur
- ◆ Constant amp draw can reduce battery power life

SHURFLO® 5000 SERIES DIAPHRAGM PUMP

5 GPM Bypass and Automatic-Demand Pumps 12 VDC



Bypass



Demand

The field-proven Shurflo 5.3 gpm [20.1 L/min] pump delivers 3.8 gpm at 40 psi [14.4 L/min at 2.75 bar] with current draw of 14 amps. This pump is designed with a Santoprene® diaphragm for chemical resistance and maximum life, as well as Viton® valves for maximum chemical resistance. Also included is a built-in pressure switch, set at 60 PSI [4.14 bar], which protects the pump in the event of dead-heading. The pump is available in the same footprint as other Shurflo pumps, allowing users to upgrade to a higher performance on existing installations.

- ◆ Field-proven pump head design
- ◆ Driven by a 12-volt, sealed motor
- ◆ Self-priming up to 8 feet [2.4 m]
- ◆ Santoprene® diaphragm for chemical resistance and maximum life
- ◆ Viton® valves provide maximum chemical resistance
- ◆ Automatic demand versions with built-in pressure switch, set at 60 psi [4.14 bar], protects the pump in the event of dead-heading
- ◆ Bypass versions set at 90 psi (5.86 bar), protects the pump in the event of dead heading
- ◆ Available in the same footprint as other Shurflo pumps, allowing users to upgrade to a higher performance on existing installations

ORDER INFORMATION - BYPASS 12VDC

Part Number	Max GPM	Max LPM	Max PSI	Max BAR	Port Size	Max Draw
5059-3611-D011	5.3	20.1	90	6.2	1/2" npsm*	20.9
5059-3610-D011	5.3	20.1	90	6.2	1/2" NPTF	20.9

* 1/2" -14 American National Standard Straight Pipe Thread

** For retail box: change "-D011" to "-D012"

BYPASS 12VDC

Model	PSI	GPM	BAR	L /min	Amps
5059-3611-D011 5059-3610-D011	0	5.3	0	20.1	6.5
	10	4.7	.7	17.8	9.0
	20	4.3	1.4	16.3	10.2
	30	4.1	2.1	15.5	12.0
	40	3.4	2.8	12.9	13.5
	50	2.6	3.4	9.8	15.2
	60	1.8	4.1	6.8	16.9
	70	1.1	4.8	4.2	18.5
	80	0.4	5.5	1.5	20.1
	90	0.0	6.2	0.0	20.9

ORDER INFORMATION - DEMAND 12VDC

Part Number	Max GPM	Max LPM	Max PSI	Max BAR	Port Size	Max Draw
5059-1311-D011	5.3	20.1	60	3.4	1/2" npsm*	17.0
5059-1310-D011	5.3	20.1	60	3.4	1/2" NPTF	17.0

* 1/2" -14 American National Standard Straight Pipe Thread

** For retail box: change "-D011" to "-D012"

DEMAND 12VDC

Model	PSI	GPM	BAR	L /min	Amps
5059-1311-D011 5059-1310-D011	0	5.3	0	20.1	6.5
	10	4.7	.69	17.8	9.0
	20	4.3	1.38	16.3	11.8
	30	4.1	2.07	15.5	12.4
	40	3.8	2.75	14.4	14.0
	50	3.6	3.45	13.6	15.4
	60	3.4	4.14	12.9	17.0

SHURFLO® 8000 SERIES DIAPHRAGM PUMP

Automatic-Demand Pumps 12 VDC



The 8000 Series diaphragm pump is Shurflo's most widely used agriculture pump. Viton® valve material assures maximum chemical resistance. The unique conical valve design delivers high flow rates at maximum discharge pressures, making the 8000 Series the pump of choice for sprayers used on the farm or around the yard. These 12 VDC pumps deliver up to 1.8 GPM [6.8 L/min] providing maximum performance in a wide range of applications.

- ◆ Self-priming up to 8 vertical feet [2.4m]
- ◆ Chemical-resistant materials
- ◆ Designed for heavy-duty spraying and fluid transfer applications
- ◆ Can run dry without damage
- ◆ Built-in check valve

ORDER INFORMATION

Part Number	Max GPM	Max LPM	Max PSI	Max BAR	Port Size	Max Draw	Description
8000-343-236	1.2	4.5	60	4.1	3/8" NPT-Female	5.8	All Viton® Pump: Viton® valves, Viton® diaphragm, 60 PSI (4.1 bar) demand switch
8000-541-236*	1.0	3.8	60	4.1	3/8" NPT-Female	3.8	Lawn and Garden Pump: Viton® valves, Santoprene® diaphragm, 60 PSI (4.1 bar) demand switch
8000-542-136	1.2	4.5	60	4.1	1/2" MSPT-Male	6.0	Low Flow Standard Pump: Viton® valves, Santoprene® diaphragm, 60 PSI (4.1 bar) demand switch
8000-543-136	1.8	6.8	60	4.1	1/2" MSPT-Male	7.3	Standard Pump: Viton® valves, Santoprene® diaphragm, 60 PSI (4.1 bar) demand switch
8000-543-236*	1.8	6.8	50	3.4	3/8" NPT-Female	6.4	Standard Pump: Viton® valves, Santoprene® diaphragm, 60 PSI (4.1 bar) demand switch
8000-543-238	1.8	6.8	100	6.9	3/8" NPT-Female	8.7	High Pressure Pump: Viton® valves, Santoprene® diaphragm, 100 PSI (6.9 bar) demand switch
8000-543-138	1.8	6.8	100	6.9	1/2" MSPT-Male	8.7	High Pressure Pump: Viton® valves, Santoprene® diaphragm, 100 PSI (6.9 bar) demand switch
8000-543-936*	1.8	6.8	50	3.4	3/8" NPT-Female	6.4	Standard Pump w/Wire Harness: Viton® valves, Santoprene® diaphragm, prewired with two wire molded connectors, 60 PSI (4.1 bar) demand switch
8000-547-189	1.8	6.8	107	7.4	1/2" MSPT-Male	7.0	High Pressure Pump: Viton® valves, Santoprene® diaphragm, 100 PSI (6.9 bar) demand switch with internal bypass
8000-643-236	1.8	6.8	60	4.1	3/8" NPT-Female	6.8	Transfer Pump: Buna valves, Geolast® diaphragm, 60 PSI (4.1 bar) demand switch
8030-813-239	1.6	6.1	150	9.5	3/8" NPT-Female	12.0	High Pressure Pump: Viton® valves, Santoprene® diaphragm, 150 PSI (10.3 bar) demand switch

* Packaged in quantities of 6. For single packs, replace "8000-" with "8009."

Viton® is a registered trademark of DuPont. Hypro® is a registered trademark of Pentair Ltd.

Model	PSI	BAR	GPM	L/min	Amps
8000-343-236	20	1.4	0.93	3.5	3.9
	40	2.8	0.84	3.2	4.9
	50	3.4	0.80	3.0	5.3
	60	4.1	0.76	2.9	5.8
8000-541-236	20	1.4	0.79	3.0	2.3
	30	2.1	0.75	2.8	2.8
	40	2.8	0.70	2.6	3.2
	60	4.1	0.62	2.3	3.8
8000-542-136	20	1.4	1.11	4.2	4.1
	40	2.8	0.98	3.7	5.1
	50	3.4	0.93	3.5	5.6
	60	4.1	0.90	3.4	6.0
8000-543-136	20	1.4	1.26	4.7	5.0
	40	2.8	1.14	4.3	6.2
	50	3.4	1.08	4.1	6.8
	60	4.1	1.02	3.9	7.3
8000-543-236	30	1.4	1.47	5.5	5.7
	40	2.8	1.41	5.3	5.8
	50	3.4	1.36	5.1	6.4
	60	4.1	1.26	4.7	6.2
8000-543-238	20	1.4	1.45	5.5	4.2
	40	2.8	1.31	5.0	5.5
	60	4.1	1.22	4.6	6.5
	100	6.9	0.96	3.6	8.7
8000-543-138	20	1.4	1.45	5.5	4.2
	40	2.8	1.31	5.0	5.5
	60	4.1	1.22	4.6	6.5
	100	6.9	0.96	3.6	8.7
8000-543-936	30	1.4	1.47	5.5	5.7
	40	2.8	1.41	5.3	5.8
	50	3.4	1.36	5.1	6.4
	60	4.1	1.26	4.7	6.2
8000-643-236	20	1.4	1.44	5.4	4.1
	40	2.8	1.33	5.0	5.4
	50	3.4	1.27	4.8	6.1
	60	4.1	1.22	4.6	6.8
8030-813-239	20	1.4	1.55	5.9	5.5
	30	2.1	1.49	5.6	6.2
	40	2.8	1.43	5.4	6.8
	80	5.4	1.20	4.5	9.1
	100	6.9	1.10	4.2	10.1
150	9.5	0.83	3.1	12.0	

SHURFLO® 8000 SERIES DIAPHRAGM PUMPS

Bypass Pumps 12 VDC



8000-543-250

8000 Series internal bypass pumps are ideal for applications where an automatic demand switch is not desired. Pumps with bypass will continue to run without damage once the bypass pressure is reached. They incorporate a triple chamber design with Viton® elastomers to withstand the toughest applications. Perfect for spot sprayers, foam markers and transfer applications where smooth, consistent flow is needed.

- ◆ Self-priming up to 8 vertical feet [2.4m]
- ◆ Chemical-resistant materials
- ◆ Internal bypass
- ◆ Can run dry without damage

ORDER INFORMATION

Part Number	Max GPM	Max LPM	Max PSI	Max BAR	Port Size	Max Draw	Description	Model	PSI	BAR	GPM	L/min	Amps
8000-543-250*	1.8	6.8	50	3.4	3/8" NPT- Female	5.5	Standard Bypass Pump: Viton® valves, Santoprene® diaphragm, 45 PSI(3.1 BAR) internal bypass	8000-543-250	20	1.4	1.30	4.9	4.0
									30	2.1	1.11	4.2	4.7
									40	2.8	0.69	2.6	5.2
									50	4.1	0.18	0.7	5.5
8000-543-210	1.3	4.9	40	2.8	3/8" NPT- Female	5.5	Standard Bypass Pump: Viton® valves, Santoprene® diaphragm, 35 PSI(2.4 BAR) internal bypass	8000-543-210	10	0.7	1.28	4.8	3.8
									20	1.4	1.19	4.5	4.4
									30	2.1	1.07	4.0	5.0
									40	2.8	0.05	0.19	5.5
8000-543-220	1.5	5.7	60	4.1	3/8" NPT- Female	7.1	Standard Bypass Pump: Viton® valves, Santoprene® diaphragm, 60 PSI(4.1 BAR) internal bypass	8000-543-220	10	0.7	1.52	5.7	3.8
									20	1.4	1.45	5.5	4.5
									30	2.1	1.39	5.3	5.2
									40	2.8	1.12	4.2	7.1
8006-543-250	1.4	5.3	50	3.4	3/8" NPT- Female	5.5	Bypass Pump with Reversed Pumphead: Viton® valves, Santoprene® diaphragm, 45 PSI(3.1 BAR) internal bypass	8006-543-220	10	0.7	1.52	5.7	3.8
									20	1.4	1.45	5.5	4.5
									30	2.1	1.39	5.3	5.2
									60	4.1	1.12	4.2	7.1
									8006-543-250	10	0.7	1.40	5.3
20	1.4	1.30	4.9	4.0									
40	2.8	0.69	2.6	5.2									
50	4.1	0.18	0.7	5.5									

* Packaged in quantities of 6. For single packs, replace "8000-" with "8009."

SHURFLO® 8000 SERIES DIAPHRAGM PUMPS

Bypass Pumps 12 VDC



8000-543-290

Designed to accommodate applications that have external pressure valves plumbed into the system.

- ◆ Self-priming up to 8 vertical feet [2.4m]
- ◆ Chemical-resistant materials
- ◆ 1/4" adapter for external bypass hook-up
- ◆ Can run dry without damage

ORDER INFORMATION

Part Number	Ma x GPM	Max LPM	Max PSI	Max BAR	Port Size	Max Draw	Description	Model	PSI	BAR	GPM	L/min	Amps
8000-543-290	1.8	6.8	100	6.9	3/8" NPT- Female	8.8	Front Adapter Pump: Viton® valves, Santoprene® diaphragm, 1/4" FNPT adapter mounted on switch ports	8000-543-290	20	1.4	1.26	4.7	5.0
									40	2.8	1.14	4.3	6.2
									60	4.1	1.02	3.9	7.3
									80	5.5	0.93	3.5	8.0
									100	6.9	0.84	3.2	8.8

Viton® is a registered trademark of DuPont. Hypro® is a registered trademark of Pentair Ltd.

SHURFLO® 8000, 8090 AND 8020 SERIES DIAPHRAGM PUMPS

Bypass and Automatic-Demand Pumps 115 VAC and 230 VAC



These Shurflo 8000, 8090 and 8020 Series bypass and demand pumps provide the same reliability as the 12 VDC version, except in a 115 VAC or 230 VAC capacity. They are ideal in agricultural applications that require high pressure with flow rates up to 1.6 GPM [6.1 L/min] and low amp draw. They can be mounted in any position, are compact, and are designed for easy maintenance.

- ◆ Self-priming up to 8 vertical feet [2.4m]
- ◆ Built-in check valve
- ◆ Chemical-resistant materials
- ◆ Corded pump optional
- ◆ Can run dry without damage

ORDER INFORMATION - BYPASS 115 VAC

Part Number	Max GPM	Max LPM	Max PSI	Max BAR	Port Size	Max Draw	Description
8000-533-250	1.4	5.3	50	3.4	3/8" NPT-Female	0.54	Bypass Pump: Viton® valves, Santoprene® diaphragm, 45 PSI (3.1 bar) Internal Bypass
8020-503-250	1.5	5.7	40	2.8	3/8" NPT-Female	0.56	Bypass Pump with 6' Power Cord: Viton® valves, Santoprene® diaphragm, 45 PSI (3.1 bar) Internal Bypass

ORDER INFORMATION - DEMAND 115 VAC

Part Numbers	Max GPM	Max LPM	Max PSI	Max BAR	Port Size	Max Draw	Description
8000-533-236	1.4	5.3	60	4.1	3/8" NPT-Female	0.64	Standard Demand Pump: Viton® valves, Santoprene® diaphragm, 60 PSI (4.1 bar) demand switch
8020-513-236	1.5	5.7	60	4.1	3/8" NPT-Female	0.57	Standard Demand Pump: Viton® valves, Santoprene® diaphragm, 60 PSI (4.1 bar) demand switch with 6 ft (1.8 m) power cord
8020-833-238	1.6	6.1	100	6.9	3/8" NPT-Female	0.95	High Pressure Pump with 6 ft. Power Cord: Viton® valves, Santoprene® diaphragm, 100 PSI (6.9 bar) demand switch
8030-863-239	1.5	5.7	150	9.7	3/8" NPT-Female	1	High Pressure Pump: Viton® valves, Santoprene® diaphragm, 150 PSI (10.3 bar) demand switch

ORDER INFORMATION - BYPASS 230 VAC

Part Numbers	Max GPM	Max LPM	Max PSI	Max Bar	Port Size	Max Draw	Description
8090-802-289	1.2	4.5	80	5.5	3/8" NPT Female	0.56	Bypass Pump: Viton® valves, Santoprene® diaphragm, 80 PSI (5.5 bar) Internal Bypass
8095-902-260	1.5	5.7	100	6.9	3/8" NPT Female	0.56	Bypass Pump: EPDM valves, Santoprene® diaphragm, 100 PSI (6.9 bar) Internal Bypass

ORDER INFORMATION - DEMAND & DEMAND/BYPASS 230 VAC

Part Numbers	Max GPM	Max LPM	Max PSI	Max BAR	Port Size	Max Draw	Description
8090-212-246	1.2	4.5	60	4.1	3/8" NPT Female	0.34	Standard Demand Pump: EPDM valves, Santoprene® diaphragm, 60 PSI (4.1 bar) demand switch
8090-801-278	1.3	4.9	100	6.9	3/8" NPT Female	0.56	Demand/Bypass Pump: Viton® valves, Santoprene® diaphragm, 80 PSI (5.5 bar) Internal Bypass, 100 PSI (6.9 bar) demand switch
8090-902-278	1.4	5.3	100	5.5	3/8" NPT Female	0.56	Demand/Bypass Pump: EPDM valves, Santoprene® diaphragm, 80 PSI (5.5 bar) Internal Bypass, 100 PSI (6.9 bar) demand switch

BYPASS 115 VAC

Model	PSI	BAR	GPM	L/min	Amps
8000-533-250	10	0.7	1.36	5.1	0.34
	30	2.1	1.05	4.0	0.46
	40	2.8	0.65	2.5	0.51
	50	3.4	0.19	0.7	0.54
8020-503-250	10	0.7	1.40	5.3	0.37
	20	1.4	1.30	4.9	0.44
	30	2.1	1.10	4.2	0.50
	40	2.8	0.80	3.0	0.56

DEMAND 115 VAC

Model	PSI	BAR	GPM	L/min	Amps
8000-533-236	20	1.4	1.15	4.3	0.46
	40	2.8	0.97	3.7	0.55
	50	3.4	0.91	3.4	0.60
	60	4.1	0.85	3.2	0.64
8020-513-236	20	1.4	1.15	4.8	0.40
	40	2.8	0.96	4.1	0.49
	50	3.4	0.90	3.6	0.54
	60	4.1	0.84	3.5	0.57
8020-833-238	20	1.4	1.32	5.0	0.45
	40	2.8	1.14	4.3	0.58
	60	4.1	1.07	4.0	0.70
	100	6.9	0.91	3.4	0.95
8030-863-239	20	1.4	1.24	4.7	0.45
	60	4.1	1.04	3.9	0.66
	120	8.3	0.77	2.9	0.92
	150	9.7	0.63	2.4	1.00

Viton® is a registered trademark of DuPont. Hypro® is a registered trademark of Pentair Ltd.

SHURFLO® 8007 SERIES DIAPHRAGM PUMPS

Bypass and Automatic-Demand 12 VDC with Electrical Package



8007-543-850
(Front and Back Shown)

These models include an aesthetically-pleasing molded assembly, housing a rocker-type manual switch with international on/off switch symbols. Wiring is neatly routed into the molded assembly through form fitting entries and strain relieved inside the housing. Fused versions come with an automotive-type fuse housed under a snug fitting cap marked "fuse." Non-fused versions have a raised section.

- ◆ Self-priming up to 8 vertical feet [2.4m]
- ◆ Chemical-resistant materials
- ◆ Internal bypass option
- ◆ Can run dry without damage
- ◆ Built-in on/off switch included
- ◆ 2 pin connector on power leads
- ◆ Available with or without integral fuse
- ◆ Rocker switch protected from the elements by a clear boot

ORDER INFORMATION -BYPASS

Part Number	Max GPM	Max LPM	Max PSI	Max BAR	Port Size	Max Draw	Description
8007-543-850	1.8	6.8	50	3.4	3/8" NPT-Female	5.5	Bypass Pump w/Electrical Package: Viton® valves, Santoprene® diaphragm, 45 PSI (3.1 bar) bypass, Manual on/off switch 2 pin connector and fuse

BYPASS 12VDC

Model	PSI	BAR	GPM	L/min	Amps
8007-543-850	10	0.7	1.40	5.3	3.4
	20	1.4	1.30	4.9	4.0
	30	2.1	1.11	4.2	4.7
	40	2.8	0.69	2.6	5.2
	50	3.4	0.18	0.7	5.5

ORDER INFORMATION -DEMAND 12VDC

Part Number	Max GPM	Max LPM	Max PSI	Max BAR	Port Size	Max Draw	Description
8007-591-236	1.0	3.8	50	3.4	3/8" NPT-Female	3.7	Demand Pump w/Electrical Package: Viton® valves, Santoprene® diaphragm, 60 PSI (4.1 bar) Demand Switch Manual on/off switch 2 pin connector (8007-543-836 includes fuse)
8007-593-836	1.8	6.8	50	3.4	3/8" NPT-Female	6.4	
8007-543-836	1.8	6.8	50	3.4	3/8" NPT-Female	6.4	

DEMAND 12VDC

Model	PSI	BAR	GPM	L/min	Amps
8007-591-236	30	2.1	0.74	2.8	2.9
	40	2.8	0.69	2.6	3.2
	50	3.4	0.65	2.5	3.7
8007-593-836	30	2.1	1.47	5.5	5.3
	40	2.8	1.41	5.3	5.8
	50	3.4	1.36	5.1	6.4
8007-543-836	30	2.1	1.47	5.5	5.3
	40	2.8	1.41	5.3	5.8
	50	3.4	1.36	5.1	6.4

SHURFLO® 2087 SERIES DIAPHRAGM PUMPS

Automatic-Demand Pump 12 VDC with Electrical Package



2087-593-135
(Front and Back Shown)

These models include an aesthetically-pleasing molded assembly, housing a rocker-type manual switch with international on/off switch symbols. Wiring is neatly routed into the molded assembly through form fitted entries and strain relieved inside the housing.

- ◆ Self-priming up to 12 vertical feet [3.7m]
- ◆ Chemical-resistant materials
- ◆ Can run dry without damage
- ◆ Rocker switch protected from the elements by a clear boot
- ◆ Built-in on/off switch included
- ◆ 2 pin connector on power lead

ORDER INFORMATION

Part Number	Max GPM	Max LPM	Max PSI	Max BAR	Port Size	Max Draw	Description	Model	PSI	BAR	GPM	L/min	Amps
2087-593-135 [†]	3	11.4	50	3.4	1/2" MSPT* Male	8	Standard Demand Pump: Viton® valves, Santoprene® diaphragm, 45 PSI (3.1 bar) demand switch	2087-593-135	10 20 30 40 50	0.7 1.4 2.1 2.8 3.4	2.80 2.69 2.36 2.05 1.42	10.6 10.2 8.9 7.8 5.4	5.3 5.5 6.7 7.7 8.0

* 1/2" - 14 National American Straight Pipe Thread
† Packaged in quantities of 6. For single pack, replace "135" with "435."

SHURFLO® 2088 SERIES DIAPHRAGM PUMPS

Automatic-Demand Pump 12 VDC



2088-343-135

Shurflo 2088 Series diaphragm pumps deliver reliable performance in high flow, moderate pressure applications. They are used in a variety of spot spraying, multi-nozzle spraying and fertilizer drip applications that require flows of up to 3.6 GPM [13.6 L/min]. They are available in a variety of chemical-resistant materials.

- ◆ Self-priming up to 12 vertical feet [3.7m]
- ◆ Chemical-resistant materials
- ◆ Can run dry without damage
- ◆ Automatic demand
- ◆ Built-in check valve (varies by model) prevents back flow of fluid into the solution tank
- ◆ Continuous duty motor on fin-cooled version

ORDER INFORMATION

Part Number	Max GPM	Max LPM	Max PSI	Max BAR	Port Size	Max Draw	Description	Model	PSI	BAR	GPM	L/min	Amps
2088-313-145	3.6	13.6	40	2.8	1/2" MSPT* Male	9.5	Standard Pump: with fin cooled motor Viton® valves, Santoprene® diaphragm, 45 PSI (3.1 bar) demand switch	2088-313-145	10 20 30 40	0.7 1.4 2.1 2.8	3.09 2.82 2.49 2.15	11.7 10.7 9.4 8.1	6.4 7.6 8.7 9.5
2088-443-144	3.5	13.2	45	3.1	1/2" MSPT* Male	9.1	Standard Pump: Santoprene® valves, Santoprene® diaphragm, 45 PSI (3.1 bar) demand switch	2088-443-144	10 20 30 40	0.7 1.4 2.1 2.8	2.83 2.56 2.31 2.02	10.7 9.7 8.7 7.6	5.8 7.0 8.0 9.1
2088-343-135 [†]	3	11.4	40	2.8	1/2" MSPT* Male	7.7	Standard Pump: Viton® valves, Santoprene® diaphragm, 45 PSI (3.1 bar) demand switch	2088-343-135	10 20 30 40	0.7 1.4 2.1 2.8	2.80 2.69 2.36 2.05	10.6 10.2 8.9 7.8	5.3 5.5 6.7 7.7

* 1/2" - 14 National American Straight Pipe Thread
† Packaged in quantities of 6. For single pack, replace "135" with "435."
Viton® is a registered trademark of DuPont. Hypro® is a registered trademark of Pentair Ltd.

SHURFLO® 2088 SERIES DIAPHRAGM PUMPS

No Control Pumps 12 VDC



2088-343-500

Shurflo 2088 Series diaphragm pumps deliver reliable performance in high flow, moderate pressure applications. They are used in a variety of spraying and transferring applications that require flows of up to 3.3 GPM [12.5 L/min]. They are available in a variety of chemical-resistant materials. They can be mounted in any position and are designed for easy maintenance.

- ◆ Self-priming up to 12 vertical feet [3.7m]
- ◆ Chemical-resistant materials
- ◆ Can run dry without damage
- ◆ Built-in check valve (may vary by models) prevents back flow of fluid through the pump
- ◆ Relief valve in the system required.

ORDER INFORMATION

Part Number	Max GPM	Max LPM	Max PSI	Max BAR	Port Size	Max Draw	Description	Model	PSI	BAR	GPM	L/min	Amps
2088-343-170	3.3	12.5	50	3.4	1/2" MSPT* Male	9.1	Front Adapter Pump with Electrical Package: Viton® valves, Santoprene® diaphragm, 1/4" FPT adapter mounted on switch port, built-in on/off power switch, fuse holder pre-wired w/2-wire molded connector, no demand switch	2088-343-170	10	0.7	3.00	11.3	5.0
								30	2.1	2.38	9.0	7.5	
								40	2.8	2.14	8.1	8.3	
								50	3.4	1.86	7.0	9.1	
2088-343-500	3.3	12.5	50	3.4	1/2" MSPT* Male	10.1	Front Adapter Pump: Viton® valves, Santoprene® diaphragm, 1/4" FPT adapter mounted on switch port, no demand switch	2088-343-500	10	0.7	2.79	10.6	5.8
								30	2.1	2.26	8.6	8.3	
								40	2.8	1.99	7.5	9.3	
								50	3.4	1.69	6.4	10.1	

* 1/2" - 14 National American Straight Pipe Thread

SHURFLO® 2088 SERIES DIAPHRAGM PUMPS

Automatic-Demand Pumps 115 & 230 VAC



2088-394-144

These Shurflo 2088 Series pumps offer the same reliability as the 12 VDC version except in 115 or 230 VAC capacity. They are used in a variety of spot spraying, mini-bulk transfer and fertilizer applications that require flows of up to 3.2 GPM [12.1 L/min]. They are available in a variety of chemical-resistant materials.

- ◆ Self-priming up to 12 vertical feet [3.7m]
- ◆ Chemical-resistant materials
- ◆ Can run dry without damage
- ◆ Automatic demand
- ◆ Built-in check valve (may vary by model) prevents back flow of fluid into the solution tank

ORDER INFORMATION

Part Number	Max GPM	Max LPM	Max PSI	Max BAR	Port Size	Max Draw	Description	Model	PSI	BAR	GPM	L/min	Amps
2088-394-144	3	11.4	40	2.8	1/2" MSPT* Male	0.7	115 VAC Pump with 6' power cord: Viton® valves, Santoprene® diaphragm, 45 PSI (3.1 bar) demand switch	2088-394-144	10	0.7	2.40	9.1	.55
								20	1.4	2.20	8.3	.60	
								30	2.1	1.90	7.2	.65	
								40	2.8	1.60	6.0	.70	
2088-394-154	3.2	12.1	40	2.8	1/2" MSPT* Male	0.98	115 VAC Pump: Viton® valves, Santoprene® diaphragm, 45 PSI (3.1 bar) demand switch	2088-394-154	10	0.7	2.71	10.2	.65
								20	1.4	2.41	9.1	.77	
								30	2.1	2.10	8.0	.89	
								40	2.8	1.84	7.0	.98	
2088-564-144	3.0	11.3	50	3.4	1/2" MSPT* Male	0.6	230 VAC Pump: Santoprene® valves, Santoprene® diaphragm, 45 PSI (3.1 bar) demand switch	2088-564-144	10	0.7	2.80	10.6	0.35
								20	1.4	2.50	9.5	0.45	
								30	2.1	2.20	8.3	0.50	
								40	2.8	2.00	7.6	0.55	
								50	3.4	1.70	6.4	0.60	

* 1/2" - 14 National American Straight Pipe Thread
Viton® is a registered trademark of DuPont. Hypro® is a registered trademark of Pentair Ltd.

SHURFLO® 166 SERIES DIAPHRAGM PUMPS

Air-Driven Pumps



166-200-36

The Shurflo 166 air-operated demand pumps employ a dual diaphragm design, with a patented fast action switching mechanism allowing for consistent flow and pressure. They are built for the toughest pumping applications and are available in a variety of elastomers that allow them to be compatible with most caustic or acidic fluids. Ideal for chemical transfer, liquid fertilizer injection and agricultural spraying. 2 chamber dual diaphragm.

- ◆ Positive displacement
- ◆ On-demand operation
- ◆ Chemical-resistant polypropylene body
- ◆ 30 to 60 PSI [2.1-4.1 bar]

ORDER INFORMATION

Part Number	Max GPM	Max LPM	Max PSI	Max BAR	Description
166-200-36	0.6	2.3	30-60	2.1-4.1	Viton® valves and diaphragm
166-200-46	0.6	2.3	30-60	2.1-4.1	Buna valves and diaphragm
166-200-56	0.6	2.3	30-60	2.1-4.1	EPDM valves and diaphragm
166-200-57	0.6	2.3	30-60	2.1-4.1	Santoprene® valves and diaphragm

SHURFLO® POWER TWIN PUMP

Demand Pumps 12VDC



4211-035

Take all the performance and features of the time-tested 2088 series, double it, and the result is the high-flow Power Twin. Delivers an open flow of 6.25 GPM [23.7 L/min] at a mere 8.7 amps. At 40 PSI [2.8 bar], it delivers 3.5 GPM [13.2 L/min] and draws only 17.2 amps. One of the most efficient high-flow self-priming pumps available today, the Power Twin is excellent for transferring, light-duty spraying, and use as a 1:1 proportioning pump.

- ◆ Up to 6.25 GPM [23.7 L/min]
- ◆ Thermally-protected motor with heat sink
- ◆ Self-priming up to 7 vertical feet (2.13 m)
- ◆ Quiet, balanced operation
- ◆ Long-life pressure switch
- ◆ Intake/Discharge manifold optional

ORDER INFORMATION

Part Number	Max GPM	Max LPM	Max PSI	Max BAR	Port Size	Max Draw	Description
4111-035	6.25	23.7	40	2.8	1/2" MPT	17.2	Viton® valves, Santoprene® diaphragm, 45 PSI (3.1 bar) demand switch, manifold with 5/8" barb ports
4211-035	6.25	23.7	40	2.8	1/2" MPT	17.2	Viton® valves, Santoprene® diaphragm, 45 PSI (3.1 bar) demand switch
4311-035	6.25	23.7	40	2.8	1/2" MPT	17.2	3/4" manifold kit included.
94-389-00							Manifold Kit 5/8" barb (2) per pump
94-389-01							Manifold Kit 3/4" barb (2) per pump

Viton® is a registered trademark of DuPont. Hypro® is a registered trademark of Pentair Ltd.

Model	PSI	BAR	GPM	L/min	Amps
4111-035	0	0	6.25	23.5	8.7
	10	0.7	5.7	21.6	12.2
	20	1.4	5.0	19.0	14.5
	30	2.1	4.3	16.2	16.1
4211-035	40	2.8	3.5	13.2	17.2
	0	0	6.25	23.5	8.7
	10	0.7	5.7	21.6	12.2
	20	1.4	5.0	19.0	14.5
4211-035	30	2.1	4.3	16.2	16.1
	40	2.8	3.5	13.2	17.2

SHURFLO® 9300 SERIES SUBMERSIBLE PUMPS

24 VDC



902-100 CONTROLLER FEATURES:

Boost your DC solar pump's performance by up to 30%. Controller optimizes your solar water pumping system by translating the current and voltage available from your photovoltaic panels, into a combination that is better matched to that needed by the pump. With the optional float switch installed, the controller will automatically stop pumping when the reservoir is full.

- ◆ Operates on 24 VDC
- ◆ Increases daily water output up to 30%
- ◆ System starts pumping earlier in the morning
- ◆ System stops pumping later in the evening
- ◆ Protects pump from low or high volume conditions
- ◆ Terminals for float switch

The Shurflo 9300 series pump offers a solution to your remote water pumping needs. It's rugged, durable and built to last. This pump delivers a steady 1.0 GPM [3.8 L/min] operating at 100 PSI [6.9 bar] maximum at 230 feet [70.1m]. It incorporates a unique, waterblocked cable connector that is impervious to water leakage and condensation problems preventing waterwicking. Great for applications in livestock watering, irrigation, ponds, islands, remote homes and cabins

- ◆ Fits wells 4 inches [10.2 cm] in diameter and larger
- ◆ Accepts a variety of jacketed cables from your power source
- ◆ Runs dry without damage
- ◆ Corrosion-proof housing with stainless steel fasteners
- ◆ Long-life, 24 VDC operation
- ◆ Quick disconnect for easy installation and service

902-200 CONTROLLER FEATURES:

Includes all 902-100 features plus:

- ◆ Switch selectable for 12 VDC or 24 VDC operation
- ◆ Manual Pump On / Off switch for easy pump maintenance
- ◆ Watertight enclosure and cable inlets
- ◆ Includes high/low water level monitor mode with probes and cable so the pump will not run when the well water is too low

ORDER INFORMATION

Part Number	Max GPM	Max LPM	Max Draw	Description
9325-043-101	1.8	6.8	4.1	EPDM valves, Santoprene® diaphragm

Model	Description	Max. Array Input Voltage		Min. Startup Voltage		Shut-down Voltage	Max. Output Current
		12V	24V	12V	24V		
902-100 (LCB-G0)	9300 DC Pump Controller	45 V	N/A	25 V	N/A	28 V	5 Amps
902-200 (LCB-G)	9300 DC Pump Controller	45 V	N/A	25 V	12.5 V	28 V	7 Amps

Model	Vertical Lift				Solar Array	Current
	Feet	Meters	GPH	LPH	Watts	Amps
9325-043-101	20	6.1	117	443	58	1.5
	60	18.3	109	413	78	2.1
	100	30.5	103	390	99	2.6
	140	42.7	99	375	115	3.1
	180	54.9	93	352	135	3.6
	230	70.1	82	310	155	4.1

SHURFLO® 3000 SERIES PUMPS

12 VDC



ORDER INFORMATION

Part Number	Max GPM	Max LPM	Max PSI	Max BAR	Max Draw
3000-350	2.5	9.5	10	0.7	7.4
3000-100 (115 Volt)	2.5	9.5	10	0.7	7.4

Model	PSI	BAR	Dischg. Ft of Head	GPM	L/min	Amps
3000-350	0	0.0	0.0	3.8	14.4	6.5
	5	0.3	11.5	3.4	12.9	7.1
	10	0.7	23.0	2.5	9.5	7.4

The 3000 Series is suitable for a variety of uses from pumping water to changing oil in cars, trucks and farm equipment. Pumps incorporate thermal overload protection.

Not intended for use with flammable liquids or in flammable environments.

- ◆ Self-priming to 7.5 feet [2.3m] vertical
- ◆ Maximum head of 28 feet [8.5m] (12 PSI [.83 bar])
- ◆ Liquid temps from 40° F to 185° F [4.4°C to 85°C]
- ◆ Thermal overload protection
- ◆ Stainless steel shaft
- ◆ BUNA-N impeller and lip seal
- ◆ Built-in reverse switch and 8 foot [2.4m] cable with battery clips
- ◆ Ports: 3/4" (M) GHT

SHURFLO® SLV SERIES DIAPHRAGM PUMPS

12 and 24 VDC Demand Pumps



SLV10-AA48
(Front and Back Shown)

The Shurflo SLV is ideal for low volume, intermittent-duty applications requiring a compact pump with low power consumption. Unique design has no metals in the fluid path for maximum chemical resistance. Pump features include automatic demand operation and elastomers that handle a wide variety of chemicals. Perfect for low volume spraying and transfer. Cost effective yet with high performance and reliability; the SLV offers tremendous value.

- ◆ Automatic demand; 25 PSI [1.72 bar] on/40 PSI [2.8 bar]
- ◆ Self-priming up to 2.5 vertical feet [.76 m]
- ◆ Long-life pressure switch
- ◆ Thermally-protected ball bearing motor with splash-proof housing
- ◆ Internal fan radiates heat; external heat sink not required
- ◆ Integral on/off switch optional

ORDER INFORMATION - AUTOMATIC DEMAND PUMPS 12 VDC

Part Number	Max GPM	Max LPM	Max PSI	Max BAR	Port Size	Max Draw	Description
SLV10-AA40	1	3.8	30	2.1	3/8" Barb	2.5	Viton® valves, Santoprene® diaphragm, 40 PSI (2.8 bar) demand switch, Integral on/off switch included
SLV10-AA41	1	3.8	30	2.1	3/8" Barb	2.5	Viton® valves, Santoprene® diaphragm, 40 PSI (2.8 bar) demand switch
SLV10-AA48*	1	3.8	30	2.1	3/8" Barb	2.5	Viton® valves, Santoprene® diaphragm, 40 PSI (2.8 bar) demand switch, Manual switch and 2 pin connector 12VDC

* Packaged in quantities of 6, for single pack, add suffix "AB" (i.e.: SLV10-AA48-AB).

AUTOMATIC DEMAND PUMPS 12 VDC

Model	PSI	BAR	GPM	L/min	Amps
SLV10-AA40	3	0.2	0.90	3.4	1.8
	10	0.7	0.73	2.8	2.1
	20	1.4	0.62	2.3	2.3
	30	2.1	0.49	1.9	2.5
SLV10-AA41	3	0.2	0.90	3.4	1.8
	10	0.7	0.73	2.8	2.1
	20	1.4	0.62	2.3	2.3
	30	2.1	0.49	1.9	2.5
SLV10-AA48	3	0.2	0.90	3.4	1.8
	10	0.7	0.73	2.8	2.1
	20	1.4	0.62	2.3	2.3
	30	2.1	0.49	1.9	2.5

ORDER INFORMATION - AUTOMATIC DEMAND PUMP 24 VDC

Part Number	Max GPM	Max LPM	Max PSI	Max BAR	Port Size	Max Draw	Description
SLV10-AB41	1	3.8	30	2.1	3/8" Barb	1.23	Viton® valves, Santoprene® diaphragm, 40 PSI (2.8 bar) demand switch

AUTOMATIC DEMAND PUMP 24 VDC

Model	PSI	BAR	GPM	L/min	Amps
SLV10-AB41	3	0.2	0.90	3.4	0.89
	10	0.7	0.73	2.8	1.00
	20	1.4	0.62	2.3	1.15
	30	2.1	0.49	1.9	1.23

ORDER INFORMATION - NO CONTROL TRANSFER PUMP 12 VDC

Part #	Max GPM	Max LPM	Max PSI	Max BAR	Port Size	Max Draw	Description
SLV10-HA01	1	3.8	30	2.1	3/8" Barb	2.5	Viton® valves, Geolast® diaphragm, No demand switch

NO CONTROL TRANSFER PUMP 12 VDC

Model	PSI	BAR	GPM	L/min	Amps
SLV10-HA01	3	0.2	0.90	3.4	1.8
	10	0.7	0.73	2.8	2.1
	20	1.4	0.62	2.3	2.3
	30	2.1	0.49	1.9	2.5

Viton® is a registered trademark of DuPont. Hypro® is a registered trademark of Pentair Ltd.

SHURFLO® ACCESSORIES

**DRILL PUMP**

Attaches to any standard 1/4" [6.35 mm] drill motor. Ideal for pumping water from appliances, aquariums, water beds, sinks, toilets or drums. Includes a 1/4" [6.35 mm] oil probe that easily allows the transfer of oil from cars, trucks, lawn and garden equipment. Not intended for use with flammable liquids or in flammable environments.

- ◆ Self-priming to 8 feet [2.4m] vertical
- ◆ Pumps liquids 40° F to 120° F [4.4° C to 48.8° C]
- ◆ BUNA impeller and seals
- ◆ 1/4" [6.35 mm] shaft fits standard drills

ORDER INFORMATION

Part Number	Max GPH	Max LPH	Port Size	Shaft Size
3010-000	200	757	3/4" (M) GHT	1/4"

**OIL CHANGE SYSTEM**

Makes a messy job clean and easy. Simply install the oil probe in the engine oil dipstick tube, attach the battery clips, and flip the switch. Oil is safely removed and stored in the easy to carry container. Oil should be heated to 140°F for maximum pump efficiency.

- ◆ Complete with necessary tubing and oil storage container
- ◆ 8 foot cable with battery clips
- ◆ Thermal overload protection

ORDER INFORMATION

Model	Description
8050-305-426	Oil Change System

HEAT SINK**ORDER INFORMATION**

Model	Description
34-007	5" [12.7 cm] Heat Sink to assist cooling in Continuous-duty applications
34-006	3" [7.6 cm] Heat Sink to assist cooling in Continuous-duty applications

BOWL-STYLE STRAINERS

Model	Description
255-223	50 Mesh screen, 1/2" Barb Inlet x 1/2 NPSM Female Outlet
255-313	50 Mesh screen, 1/2" NPSM Male Inlet x 1/2 NPSM Female Outlet, EPDM O-ring
255-323	50 Mesh screen, 1/2" Barb Inlet x 1/2 NPSM Female Outlet, EPDM O-ring
255-646	50 Mesh screen, 3/8" x 3/8" MNPT Poly/Nylon, Viton® O-ring
255-568	50 Mesh screen, 3/8" x 3/8" MNPT Poly/Nylon, EPDM O-ring
255-613	50 Mesh screen, 1/2" NPSM Male Inlet x 1/2 NPSM Female Outlet, Viton® O-ring
255-623	50 Mesh screen, 1/2" Barb Inlet x 1/2 NPSM Female Outlet, Viton® O-ring
255-413	50 Mesh screen, 1/2" NPSM Male Inlet x 1/2 NPSM Female Outlet, Buna O-ring



BARB TEE

Part Number	Description
8-126-00	1/2" [12mm] Barb Tee - Polypro



BARB TEE X PIPE

Part Number	Description
T3812T	3/8" [10mm] MNPT-Male x 1/2" Barb Tee - Nylon
3T3812T	3/8" [10mm] MNPT-Male x 1/2" Barb Tee - Poly



SWIVEL HEX WINGNUT STRAIGHT (USE WITH 2088 SERIES)

Part Number	Description
234-2916	1/2" [12mm] NPT-Female x 3/8" [10 mm] Barb - Polypro
234-2926	1/2" [12mm] NPT-Female x 1/2" [12 mm] Barb - Polypro
234-2936	1/2" [12mm] NPT-Female x 5/8" [16 mm] Barb - Polypro
234-2946	1/2" [12mm] NPT-Female x 3/4" [19 mm] Barb - Polypro



SWIVEL HEXNUT ELBOW (USE WITH 2088 SERIES)

Part Number	Description
234-3926	1/2" [12mm] NPT-Female x 1/2" [12 mm] Barb Swivel Hexnut Elbow - Polypro
244-3366	1/2" [12mm] NPT-Female x 1/2" [12 mm] NPT Male Swivel Hexnut Elbow Adaptor - Nylon
234-3916	1/2" [12mm] NPT-Female x 3/8" [10 mm] Barb Swivel Hexnut Elbow - Polypro
234-3946	1/2" [12mm] NPT-Female x 3/4" [19 mm] Barb Swivel Elbow - Polypro
234-3936	1/2" [12mm] NPT-Female x 5/8" [16 mm] Barb Swivel Elbow - Polypro

*Fitting available only in nylon - CHECK COMPATIBILITY.



BARBED X PIPE STRAIGHT

Part Number	Description
8-005-01	3/8" [10mm] NPT-Male x 3/8" [10 mm] Barb - Polypro
8-007-01	3/8" [10mm] NPT-Male x 1/2" [12 mm] Barb - Polypro
244-5126	1/2" [12mm] NPT-Male x 1/2" [12 mm] Barb - Nylon



BARBED X PIPE ELBOW

Part Number	Description
8-006-01	3/8" [10mm] NPT-Male x 3/8" [10 mm] Barb - Poly
244-6128	3/8" [10mm] NPT-Male x 1/2" [12 mm] Barb - Poly



8-145-00



8-150-01



8-205-00

ADAPTERS

Part Number	Description
8-145-00	3/8" [10mm] NPT-Male x 1/2" [12 mm] NPT-Male - Polypro
8-150-01*	1/2" [12mm] NPT-Female x 3/4" [19 mm] GHT (M) - Nylon
8-205-00	1/2" [12mm] NPT-Female x 1/2" [12 mm] NPT-Male - Aceryl

*Fitting available only in nylon - CHECK COMPATIBILITY.



The Shurflo AG Runner Transfer Pump System is designed to safely and accurately transfer bulk chemicals to the point of use.

- ◆ Industry leading pump
- ◆ Portable
- ◆ Can be used with a variety of bulk containers
- ◆ Built for rugged service with a heavy-duty welded frame
- ◆ Simple and accurate flow indicator

ORDER INFORMATION

Part Number	Flow Meter Type	Description
SF-1100-PTS	Pump-mounted (FM-1100)	Chemical Transfer Pump with 12 VDC motor, 20 ft. (6 m) cable, alligator clips and in-line fuse (Part # SF-1100 - EPDM valves or SF-1105 - Viton® valves), electronic flow meter, 1-in. NPT x 12 ft. (3.7 m) EPDM discharge hose with ball valve/spout, and 1-in. NPT x 12 ft. (3.7 m) EPDM inlet hose with 1-in. elbow/ball valve/fitting assembly with locking cam arms
SF-1100-PTSi	Inline (FM-1100i)	
SF-1100-PTSi-00	No Flow Meter	
SF-1105-PTS	Pump-mounted (FM-1100)	
SF-1105-PTSi	Inline (FM-1100i)	

See Mini-Bulk Pump (pg. 108) for performance information.



SHURFLO MINI-BULK CHEMICAL TRANSFER SYSTEM



Shurflo Mini-Bulk Chemical Transfer Pumps and Systems are designed specifically for chemical company tanks where the pump is integral to the tank. The SF-1100-REC system is mounted to any tank with a 9-inch, threaded opening. This system allows the pump to recirculate the suspended chemical components prior to transferring to the point of use.

ORDER INFORMATION

Part Number	Description
SF-1100-REC-DT	Chemical Transfer Pump with 12 VDC motor, 20 ft. (6 m) cable, alligator clips & in-line fuse (Part # SF-1100 - EPDM valves or SF-1105 - Viton® valves), in-line electronic flow meter (Part # FM-1100i), 1-in. NPT x 12 ft. (3.7 m) EPDM discharge hose with ball valve/spout, 3-way valve, tubing and fittings to allow tank recirculation, and 28" (71 cm) dip tube. (SF-1100-REC-DT only)
SF-1105-REC*	

See Mini-Bulk Pump (pg. 108) for performance information.

* Does not come with 28" dip tube. To order dip tube separately use part number 2407-0002



SHURFLO® MINI-BULK PUMPS



The SF-1100 Series Bulk Chemical Pumps are the industry leader. They are designed for efficiency and power to handle highly viscous fluids. Servicing the SF-1100 series pump is a rare event, but if needed, it can be serviced quickly and easily with only a few hand tools.

- ◆ Specialized EPDM elastics or Viton® option
- ◆ 12 volt DC or 110 volt AC motor option
- ◆ 20 foot (6 m) cord with alligator clips and in-line fuse (DC version), 6 foot (1.8) cord (AC version)
- ◆ Weather protected on/off switch
- ◆ Internal bypass to protect the pump at shut-off
- ◆ 2" MNPT inlet, 1" FNPT outlet
- ◆ Capable of priming up to 12 feet (3.7 m)
- ◆ Max Viscosity: 600-880 Centipoise

ORDER INFORMATION

Part Number	Valves	Motor
SF-1100	EPDM	12 VDC
SF-1100-110V	EPDM	110 VAC
SF-1105	Viton®	12 VDC

Model	PSI	BAR	GPM	L/min	Amps
SF-1100 and SF-1105	0	0.0	10.7	40	9.3
	5	0.3	10.1	38	10.3
	10	0.7	8.7	33	12.3
	15	1.0	7.6	29	13.9

SHURFLO® MINI-BULK FLOW METERS



The FM-1100 Series Electronic Flow Meter is designed for accurate and easy measuring of transferred chemicals. The FM-1100 Series Flow Meter is an integral component for a complete bulk chemical transfer system.

- ◆ Max. flow of 20 gpm (76 lpm) (.5% accuracy after calibration)
- ◆ Max pressure of 120 psi (8.3 bar)
- ◆ Accurate nutating disk design
- ◆ Large LCD display makes meter reading easy from a distance
- ◆ Simple calibration steps and control button layout
- ◆ Long-life lithium battery
- ◆ Easy-to-service electronics and batteries
- ◆ Available in pump-mounted and hose-end configurations
- ◆ Max Viscosity: 600-880 Centipoise

ORDER INFORMATION

Part Number	Max GPM	Max LPM	Max PSI	Max BAR	Description
FM-1100	20	76	120	8.3	Pump-mounted meter kit- 1" MNPT inlet & outlet
FM-1100i	20	76	120	8.3	Inline meter kit -1" FNPT inlet & outlet

Viton® is a registered trademark of DuPont. Hypro® is a registered trademark of Pentair Ltd.

SHURFLO® MINI-BULK KITS, PARTS, & ACCESSORIES



Part# 94-718-00



Part# 94-719-00

Part# 94-720-00
& 94-720-05

Part# 94-721-00

MINI-BULK PUMP KITS FOR SF-1100 SERIES

Part Number	Description
94-718-00	Motor assembly kit used in any SF-1100 series pumps. Kit includes a 12 VDC motor with integrated pump lower housing, built-in on-off switch, 20 foot (6 m) cable, alligator clips and in-line fuse (Support bracket part # 84-1038-08)
94-719-00	Santoprene® diaphragm/lower housing/drive assembly - ready for installation
94-720-00	EPDM valve housing kits include a complete fully-assembled valve housing with o-ring seal* - ready for installation
94-720-05	Viton® valve housing kits include a complete fully-assembled valve housing with o-ring seal* - ready for installation
94-721-00	Polypropylene upper housing - includes o-ring seal* and pump head screws

* Manufacturer recommends replacing the O-ring seal whenever the pump has been dismantled.



Part# 94-732-00



Part# 94-733-00



Part# 94-734-00



Part# 94-735-00



Part# 94-736-00

MINI-BULK FLOW METER KITS FOR FM-1100 SERIES

Part Number	Description
94-732-00	Flow meter electronics kit includes the front cover assembly and the electronic display with o-ring and batteries. Kit fits both pump-mounted and in-line meters(O-ring part # 5-040-154)
94-733-00	Flow meter housing seal cover kit includes the seal cover, o-ring and screws. Kit fits both pump-mounted and in-line meters.(O-ring part # 5-040-154)
94-734-00	Nutating chamber assembly, including o-ring seal. Kit fits both pump-mounted and in-line meters
94-735-00	90° meter housing with o-ring seal for pump-mounted flow meter. (O-ring part # 5-043-240)
94-736-00	Meter housing with o-ring seal for in-line flow meter. (O-ring part # 5-043-240)



Part# 3320-0064



Part# 8-727-00



Part# 94-712-00



Part# 94-716-00



Part# 94-717-00



Part# 94-723-00



Part# 94-724-00



Part# 94-725-00



Part# 94-737-00



Part# 94-738-00

OTHER MINI-BULK PARTS & ACCESSORIES

Part Number	Description
3320-0064	Anti-flow back valve for EPA compliance
8-727-00	2 inch FNPT by 1 Inch FNPT polypropylene reducer coupling
94-712-00	2 inch male NPT by 2 inch female NPT street elbow fitting
94-716-00	1 inch NPT ball valve with spout
94-717-00	1 inch NPT x 12 foot EPDM discharge hose kit
94-723-00	Set of red and black alligator clips, including fuse holder
94-724-00	Replacement recirculation lid (Gasket part # 7-155-00)
94-725-00	Replacement recirculation cap
94-737-00	Recirculation system return hose kit - includes return hose and two hose clamps
94-738-00	Elbow, valve and coupling assembly - includes a 1 inch street elbow, 1 inch ball valve, and 1 inch bayonet tank coupling

STAINLESS STEEL, TRIPLEX PLUNGER PUMPS

Model 2535S and 2545S



Shown with optional mounting kit (kit P/N 3430-0645)

ORDER INFORMATION

Model Number	Max. GPM	Max. PSI	Max. RPM	Inlet Port	Outlet Port
2535S	38	1200	800	1-1/2" NPT	1" NPT
2545S	47	1200	800	1-1/2" NPT	1" NPT
3430-0645	Base Rail Kit				
3430-0699	2535S Mobile Repair Kit (See below for details)				

HEAD

- ◆ 100% 316 stainless steel head and two-piece manifold resists washout and corrosion
- ◆ Stainless steel fasteners provide additional protection against environmental elements
- ◆ Heavy-duty, high pressure seals and back-up washers are included to guard against corrosion and continuous duty fatigue
- ◆ Precision-machined, stainless steel valve and seats provide higher resistance to chemical attack
- ◆ Self-adjusting, spring-loaded, double V-packings maintain constant high pressure seal compression and extend seal and plunger life
- ◆ High density ceramic plungers increase the high pressure seal life
- ◆ Lifetime warranty on the stainless steel head

BODY

- ◆ Oversized crankshaft, bearings and bronze connecting rod can handle the abuse of cold start-ups and intermittent operation
- ◆ Forged stainless steel plunger rod stepped between plunger guide and oil seal eliminates seal failure due to plunger rod wear
- ◆ Heavy-duty oil seals for longer life
- ◆ 5-year warranty on material & workmanship

2535S

U.S. UNITS

PSI	800		1000		1200		
	RPM	GPM	HP	GPM	HP	GPM	HP
400		19.8	11.2	19.7	13.0	19.5	15.2
500		24.3	13.1	24.2	15.8	24.1	18.8
600		29.2	15.3	29.2	18.8	29.0	22.2
700		33.6	18.1	33.5	22.2	33.5	25.8
800		38.1	20.0	38.0	25.0	38.0	29.8

2535S

METRIC UNITS

BAR	55		69		83		
	RPM	L/m	Kw	L/m	Kw	L/m	Kw
400		75.0	8.4	74.6	9.7	73.8	11.3
500		92.0	9.8	91.6	11.8	91.2	14.0
600		110.5	11.4	110.5	14.0	109.8	16.6
700		127.2	13.5	126.8	16.6	126.8	19.2
800		144.2	14.9	143.8	18.6	143.8	22.2

STAINLESS STEEL, TRIPLEX PLUNGER PUMPS

Model 2535S and 2545S

2545S

U.S. UNITS

PSI	800		1000		1200		
	RPM	GPM	HP	GPM	HP	GPM	HP
400		24.4	13.2	24.2	16.0	24.1	18.9
500		30.4	16.1	30.3	19.6	30.2	23.1
600		36.5	19.2	36.5	23.2	36.4	27.5
700		42.1	22.1	42.1	27.1	42.0	32.3
800		46.8	25.1	46.8	30.4	46.7	36.1

2545S

METRIC UNITS

BAR	55		69		83		
	RPM	L/m	Kw	L/m	Kw	L/m	Kw
400		92.4	9.8	91.6	11.9	91.2	14.1
500		115.1	12.0	114.7	14.6	114.3	17.2
600		138.2	14.3	138.2	17.3	137.8	20.5
700		159.4	16.5	159.4	20.2	159.0	24.1
800		177.2	18.7	177.2	22.7	176.8	26.9



2535S MOBILE REPAIR KIT (MODEL NUMBER: 3430-0699)

FEATURES

- ◆ Complete kit to rebuild the wet-end of the 2535S plunger pump
- ◆ Replace individual parts as needed or the entire wet-end
- ◆ As parts are used, reorder to keep mobile kit fully stocked
- ◆ Save time and money by having all the parts at your finger tips in an easy-to-carry case

CONTAINS

- ◆ 3010-0168 Tool Box
- ◆ 3430-0640 Valve Kit
- ◆ 3430-0641 Packing Kit
- ◆ 3430-0643 Plunger Seal Kit
- ◆ 3430-0644 Rod Oil Seal Kit
- ◆ 9910-621010 Bolt to Remove Valves
- ◆ 2160-0061 Anti-Seize Tube
- ◆ 3010-0250 Tool for Installing Cups
- ◆ L-1500 Repair Manual

FORGED BRASS HEAD, TRIPLEX PLUNGER PUMPS

Series 2400B-P



HEAD

- ◆ Single-piece forged brass heads
- ◆ Quick and easy pump packing replacement
- ◆ Precision-machined stainless steel valve and seats provide higher resistance to chemical attack
- ◆ 100% ceramic plungers
- ◆ Dual low pressure packing design for improved priming capabilities
- ◆ Lifetime warranty on single-piece forged brass heads

BODY

- ◆ Hypro's state-of-the-art, patented cartridge technology allows the crankcase oil seals and all wet-end seals to be easily serviced by removing only the pump head
- ◆ Hardened stainless steel lower plungers offer superior corrosion and wear resistance
- ◆ Longer lasting drive system with heavy-duty ball bearings
- ◆ Bronze piston guides give you larger bearing surface for extended life on oil seals and plungers
- ◆ 1" OD Solid Shaft
- ◆ Heavy-duty oil seals
- ◆ O-ring sealed dipstick
- ◆ Includes rail mounting kit
- ◆ 5-year warranty on material & workmanship

ORDER INFORMATION - 2410B-P SERIES

Model Number	Max. GPM	Max. PSI	Max. RPM	Inlet Port	Outlet Port
2410B-P	4.4	2500	1725	3/4"	1/2"
2411B-P	5.3	2500	1725	3/4"	1/2"
2412B-P	5.9/4.0	2500	1725/1100	3/4"	1/2"
2413B-P	7.2	1800	1725	3/4"	1/2"
2414B-P	8.0/4.0	1800	1725/1100	3/4"	1/2"

Left-hand shaft extension - add suffix "L" - (i.e. 2410B-LP)

ORDER INFORMATION - 2430B-P SERIES

Model Number	Max. GPM	Max. PSI	Max. RPM	Inlet Port	Outlet Port
2430B-P	4.3	3600	1725	3/4"	1/2"
2431B-P	5.1	3600	1725	3/4"	1/2"
2432B-P	5.8	3600	1725	3/4"	1/2"
2433B-P	7.1	2500	1725	3/4"	1/2"
2434B-P	7.9	2500	1725	3/4"	1/2"

Left-hand shaft extension - add suffix "L" - (i.e. 2430B-LP)

2410B-P

U.S. UNITS

PSI	1000		1500		2000		2500	
	RPM	GPM	HP	RPM	GPM	HP	RPM	GPM
1000	2.7	1.9	2.7	2.7	2.6	3.4	2.6	4.1
1150	3.1	2.1	3.1	3.0	3.0	3.8	3.0	4.6
1450	3.9	2.6	3.9	3.7	3.8	4.8	3.7	5.8
1725	4.6	3.1	4.5	4.4	4.4	5.7	4.4	6.9

2411B-P

PSI	1000		1500		2000		2500	
	RPM	GPM	HP	RPM	GPM	HP	RPM	GPM
1000	3.2	2.4	3.2	3.3	3.1	4.2	3.1	5.1
1150	3.7	2.5	3.7	3.6	3.6	4.6	3.6	5.6
1450	4.6	3.1	4.6	4.4	4.5	5.7	4.5	7.0
1725	5.3	3.7	5.3	5.2	5.2	6.7	5.1	8.1

2412B-P

PSI	1000		1500		2000		2500	
	RPM	GPM	HP	RPM	GPM	HP	RPM	GPM
1000	3.6	2.7	3.5	3.6	3.5	4.6	3.5	5.6
1150	4.1	2.9	4.1	4.1	4.0	5.2	4.0	6.4
1450	5.1	3.7	5.1	5.1	5.0	6.6	5.0	8.0
1725	5.9	4.2	5.9	5.9	5.8	7.7	5.7	9.4

2410B-P

METRIC UNITS

BAR	69		103		138		172	
	RPM	L/m	Kw	RPM	L/m	Kw	RPM	L/m
1000	10.2	1.4	10.0	2.0	9.8	2.5	9.7	3.1
1150	11.7	1.6	11.5	2.2	11.4	2.8	11.2	3.4
1450	14.8	1.9	14.6	2.8	14.4	3.6	14.0	4.3
1725	17.4	2.3	17.0	3.3	16.7	4.3	16.5	5.1

2411B-P

BAR	69		103		138		172	
	RPM	L/m	Kw	RPM	L/m	Kw	RPM	L/m
1000	12.1	1.8	11.9	2.5	11.7	3.1	11.7	3.8
1150	14.0	1.9	13.8	2.6	13.6	3.4	13.4	4.2
1450	17.4	2.3	17.2	3.3	17.0	4.3	16.8	5.2
1725	20.1	2.8	19.9	3.9	19.7	5.0	19.3	6.0

2412B-P

BAR	69		103		138		172	
	RPM	L/m	Kw	RPM	L/m	Kw	RPM	L/m
1000	13.6	2.0	13.2	2.7	13.2	3.4	13.2	4.2
1150	15.5	2.2	15.5	3.1	15.1	3.9	15.1	4.8
1450	19.3	2.8	19.3	3.8	18.9	4.9	18.9	6.0
1725	22.3	3.1	22.3	4.4	22.0	5.7	21.6	7.0

FORGED BRASS HEAD, TRIPLEX PLUNGER PUMPS

Series 2400B-P

2413B-P U.S. UNITS

PSI	500		1000		1500		1800	
	RPM	GPM	HP	RPM	HP	RPM	HP	RPM
1000	4.4	1.8	4.4	3.0	4.3	4.2	4.3	5.0
1150	5.1	1.9	5.0	3.3	5.0	4.8	4.9	5.7
1450	6.3	2.5	6.2	4.2	6.1	5.9	6.1	7.0
1725	7.2	2.9	7.1	4.9	7.0	6.8	7.0	8.1

2414B-P

PSI	500		1000		1500		1800	
	RPM	GPM	HP	RPM	HP	RPM	HP	RPM
1000	5.0	1.9	4.9	3.3	4.9	4.7	4.9	5.5
1150	5.7	2.0	5.6	3.7	5.6	5.3	5.6	6.3
1450	7.0	2.5	6.9	4.6	6.9	6.6	6.8	7.8
1725	7.9	3.0	7.8	5.3	7.7	7.6	7.7	8.8

2430B-P

PSI	1000		2000		3000		3600	
	RPM	GPM	HP	RPM	HP	RPM	HP	RPM
1000	2.7	1.9	2.6	3.4	2.5	4.8	2.5	5.6
1150	3.1	2.1	3.0	3.8	2.9	5.4	2.8	6.4
1450	3.9	2.6	3.8	4.8	3.6	6.8	3.6	8.0
1725	4.6	3.1	4.4	5.7	4.3	8.1	4.2	9.5

2431B-P

PSI	1000		2000		3000		3600	
	RPM	GPM	HP	RPM	HP	RPM	HP	RPM
1000	3.2	2.4	3.1	4.2	3.1	5.9	3.0	6.8
1150	3.7	2.5	3.6	4.6	3.5	6.6	3.5	7.7
1450	4.6	3.1	4.5	5.7	4.4	8.2	4.3	9.8
1725	5.3	3.7	5.2	6.7	5.0	9.5	5.0	11.2

2432B-P

PSI	1000		1500		3000		3600	
	RPM	GPM	HP	RPM	HP	RPM	HP	RPM
1000	3.6	2.6	3.5	4.7	3.4	6.9	3.4	7.8
1150	4.1	2.9	4.0	5.3	4.0	7.5	3.9	8.8
1450	5.2	3.6	5.0	6.6	4.9	9.4	4.8	11.0
1725	6.0	4.2	5.8	7.6	5.7	10.9	5.6	12.8

2433B-P

PSI	1000		1500		2000		2500	
	RPM	GPM	HP	RPM	HP	RPM	HP	RPM
1000	4.4	3.0	4.3	4.2	4.3	5.5	4.3	6.7
1150	5.0	3.3	5.0	4.8	4.9	6.2	4.9	7.6
1450	6.2	4.2	6.1	5.9	6.1	7.7	6.0	9.4
1725	7.1	4.9	7.0	6.8	7.0	8.9	6.9	10.8

2434B-P

PSI	1000		1500		2000		2500	
	RPM	GPM	HP	RPM	HP	RPM	HP	RPM
1000	4.9	3.4	4.9	4.8	4.8	6.2	4.8	7.6
1150	5.6	3.8	5.6	5.4	5.5	7.1	5.5	8.5
1450	7.0	4.5	6.9	6.5	6.8	8.6	6.8	10.5
1725	7.9	5.3	7.8	7.7	7.8	10.0	7.7	12.1

2413B-P METRIC UNITS

BAR	34		69		103		124	
	RPM	L/m	Kw	RPM	Kw	RPM	Kw	RPM
1000	16.7	1.3	16.7	2.2	16.3	3.1	16.4	3.7
1150	19.1	1.4	18.9	2.5	18.9	3.6	18.7	4.2
1450	23.7	1.8	23.5	3.1	23.1	4.4	23.2	5.2
1725	27.1	2.2	26.9	3.7	26.5	5.1	26.6	6.1

2414B-P

BAR	34		69		103		124	
	RPM	L/m	Kw	RPM	Kw	RPM	Kw	RPM
1000	18.9	1.4	18.5	2.5	18.5	3.5	18.5	4.1
1150	21.6	1.5	21.2	2.8	21.2	4.0	21.2	4.7
1450	26.5	1.9	26.1	3.4	26.1	4.9	25.7	5.8
1725	29.9	2.2	29.5	4.0	29.1	5.7	29.1	6.6

2430B-P

BAR	69		138		207		248	
	RPM	L/m	Kw	RPM	Kw	RPM	Kw	RPM
1000	10.2	1.4	9.8	2.5	9.5	3.6	9.5	4.2
1150	11.7	1.6	11.4	2.8	11.0	4.0	10.6	4.8
1450	14.8	1.9	14.4	3.6	13.6	5.1	13.6	6.0
1725	17.4	2.3	16.7	4.3	16.3	6.0	15.9	7.1

2431B-P

BAR	69		138		207		248	
	RPM	L/m	Kw	RPM	Kw	RPM	Kw	RPM
1000	12.1	1.8	11.7	3.1	11.7	4.4	11.4	5.1
1150	14.0	1.9	13.6	3.4	13.2	4.9	13.2	5.7
1450	17.4	2.3	17.0	4.3	16.7	6.1	16.3	7.3
1725	20.1	2.8	19.7	5.0	18.9	7.1	18.9	8.4

2432B-P

BAR	69		138		207		248	
	RPM	L/m	Kw	RPM	Kw	RPM	Kw	RPM
1000	13.6	1.9	13.2	3.5	12.9	5.1	12.9	5.8
1150	15.5	2.2	15.1	4.0	15.1	5.6	14.8	6.6
1450	19.7	2.7	18.9	4.9	18.5	7.0	18.2	8.2
1725	22.7	3.1	22.0	5.7	21.6	8.1	21.2	9.5

2433B-P

BAR	69		103		138		172	
	RPM	L/m	Kw	RPM	Kw	RPM	Kw	RPM
1000	16.7	2.2	16.3	3.1	16.3	4.1	16.3	5.0
1150	18.9	2.5	18.9	3.6	18.5	4.6	18.5	5.7
1450	23.5	3.1	23.1	4.4	23.1	5.7	22.7	7.0
1725	26.9	3.7	26.5	5.1	26.5	6.6	26.1	8.1

2434B-P

BAR	69		103		138		172	
	RPM	L/m	Kw	RPM	Kw	RPM	Kw	RPM
1000	18.5	2.5	18.5	3.6	18.2	4.6	18.2	5.7
1150	21.2	2.8	21.2	4.0	20.8	5.3	20.8	6.3
1450	26.5	3.4	26.1	4.8	25.7	6.4	25.7	7.8
1725	29.9	4.0	29.5	5.7	29.5	7.5	29.1	9.0

FORGED BRASS HEAD, TRIPLEX PLUNGER PUMPS

Series 2300B-P



HEAD

- ◆ Single-piece forged brass heads
- ◆ Quick and easy pump packing replacement
- ◆ Precision-machined stainless steel valve and seats provide higher resistance to chemical attack
- ◆ 100% ceramic plungers
- ◆ Dual low pressure packing design for improved priming capabilities
- ◆ Lifetime warranty on single-piece forged brass heads

BODY

- ◆ Hypro's state-of-the-art, patented cartridge technology allows the crankcase oil seals and all wet-end seals to be easily serviced by removing only the pump head
- ◆ Hardened stainless steel lower plungers offer superior corrosion and wear resistance
- ◆ Shafts Output:
 - 3/4" OD Solid Shaft - 2303B-P, 2304B-P, 2314B-P, 2330B-P, 2351B-P & 2345B-P
 - 3/4" OD Solid Shaft with M6 x 1" Tapped Thread for clutch installation - 2359B-P & 2340B-P
 - 3/4" OD Solid Shaft with 6" electric clutch assembly - 2359B-PY
 - 3/4" ID Hollow Shaft Flanged for direct couple to gasoline engines - 2354B-CP & 2331B-CP
- ◆ Heavy-duty oil seals
- ◆ O-ring sealed dipstick
- ◆ Includes rail mounting kit
- ◆ 5-year warranty on material & workmanship

ORDER INFORMATION - 2304B-P, 2314B-P

Model Number	Max. GPM	Max. PSI	Max. RPM	Inlet Port	Outlet Port
2304B-P	4.2	1200	1725	1/2"	3/8"
2314B-P	4.0/3.0	1200	1450/1100	1/2"	3/8"

Left-hand shaft extension - add suffix "L" - (i.e. 2303B-LP)

ORDER INFORMATION - 2330B-P, 2359B-P, 2351B-P, 2340B-P, 2354B-P

Model Number	Max. GPM	Max. PSI	Max. RPM	Inlet Port	Outlet Port
2330B-P	3.1	2500	1725	1/2"	3/8"
2359B-P*	3.5	3000	1725	1/2"	3/8"
2351B-P	4.0	3000	1725	1/2"	3/8"
2340B-P*	4.2	2500	1725	1/2"	3/8"
2354B-P	4.8	2500	1725	1/2"	3/8"

Left-hand shaft extension - add suffix "L" - (i.e. 2330B-LP)

*With m6 x 1" threaded shaft for Clutch installation

ORDER INFORMATION - 2354B-CP, 2331B-CP

Model Number	Max. GPM	Max. PSI	Max. RPM	Inlet Port	Outlet Port
2354B-CP	2.7	2000	3450	1/2"	3/8"

Left-hand shaft extension - add suffix "L" - (i.e. 2354B-CLP)

ORDER INFORMATION - 2359B-PY

Model Number	Max. GPM	Max. PSI	Max. RPM	Inlet Port	Outlet Port
2359B-PY	3.5	3000	1725	1/2"	3/8"

Left-hand shaft extension - add suffix "L" - (i.e. 2359B-LPY)

2303B-P, 2304B-P, 2314B-P

U.S. UNITS

PSI	500		700		1000		1200	
	RPM	GPM	HP	GPM	HP	GPM	HP	GPM
1100	3.1	1.3	3.1	1.6	3.1	2.1	3.1	2.4
1450*	4.1	1.5	4.0	2.0	4.0	2.7	4.0	3.2
1725**	3.1	1.2	3.1	1.7	3.1	2.2	3.1	2.6
1725***	4.3	1.6	4.3	2.0	4.2	2.9	4.2	3.4

* 2314 only, ** 2303 only, *** 2304 only

2303B-P, 2304B-P, 2314B-P

METRIC UNITS

BAR	34		48		69		83	
	RPM	L/m	Kw	L/m	Kw	L/m	Kw	L/m
1100	11.7	1.0	11.7	1.2	11.7	1.6	11.7	1.8
1450*	15.5	1.1	15.1	1.5	15.1	2.0	15.1	2.4
1725**	11.7	0.9	11.7	1.3	11.7	1.6	11.7	1.9
1725***	16.3	1.2	16.3	1.5	15.9	2.2	15.9	2.5

* 2314 only, ** 2303 only, *** 2304 only

FORGED BRASS HEAD, TRIPLEX PLUNGER PUMPS

Series 2300B-P

2330B-P

U.S. UNITS

PSI	500		700		1000		1300		1500		2000	
RPM	GPM	HP	GPM	HP	GPM	HP	GPM	HP	GPM	HP	GPM	HP
1000	1.8	0.7	1.8	1.0	1.8	1.3	1.8	1.6	1.8	1.9	1.8	2.9
1450	2.7	1.0	2.7	1.4	2.6	1.9	2.6	2.3	2.6	2.7	2.5	4.2
1600	2.9	1.1	2.9	1.5	2.9	2.0	2.9	2.5	2.8	2.8	2.8	4.6
1725	3.1	1.2	3.1	1.7	3.1	2.2	3.1	2.8	3.1	3.2	3.0	5.0

2330B-P

METRIC UNITS

BAR	34		48		69		90		103		172	
RPM	L/m	Kw	L/m	Kw	L/m	Kw	L/m	Kw	L/m	Kw	L/m	Kw
1000	6.8	0.5	6.8	0.7	6.8	1.0	6.8	1.2	6.8	1.4	6.8	2.2
1450	10.2	0.7	10.2	1.0	9.8	1.4	9.8	1.7	9.8	2.0	9.5	3.1
1600	11.0	0.8	11.0	1.1	11.0	1.5	11.0	1.9	10.6	2.1	10.6	3.4
1725	11.7	0.9	11.7	1.3	11.7	1.6	11.7	2.1	11.7	2.4	11.4	3.7

2340B-P

PSI	500		700		1000		1300		1500		2000	
RPM	GPM	HP	GPM	HP	GPM	HP	GPM	HP	GPM	HP	GPM	HP
1000	2.5	1.0	2.5	1.3	2.5	1.8	2.5	2.2	2.5	2.5	2.4	4.0
1450	3.6	1.3	3.6	1.8	3.6	2.4	3.6	3.1	3.5	3.6	3.5	5.6
1600	4.0	1.5	4.0	1.9	3.9	2.7	3.9	3.3	3.9	3.8	3.8	6.2
1725	4.3	1.6	4.3	2.0	4.2	2.9	4.2	3.6	4.2	4.1	4.1	6.6

2340B-P

BAR	34		48		69		90		103		172	
RPM	L/m	Kw	L/m	Kw	L/m	Kw	L/m	Kw	L/m	Kw	L/m	Kw
1000	9.5	0.7	9.5	1.0	9.5	1.3	9.5	1.6	9.5	1.9	9.1	3.0
1450	13.6	1.0	13.6	1.3	13.6	1.8	13.6	2.3	13.2	2.7	13.2	4.2
1600	15.1	1.1	15.1	1.4	14.8	2.0	14.8	2.5	14.8	2.8	14.4	4.6
1725	16.3	1.2	16.3	1.5	15.9	2.2	15.9	2.7	15.9	3.1	15.5	4.9

2345B-P

PSI	500		700		1000		1300		1500		2000	
RPM	GPM	HP	GPM	HP	GPM	HP	GPM	HP	GPM	HP	GPM	HP
1000	2.8	1.2	2.8	1.5	2.8	2.0	2.8	2.5	2.8	2.8	2.7	4.5
1450	4.1	1.7	4.1	2.2	4.0	2.9	4.0	3.7	4.0	4.1	4.0	6.5
1600	4.5	1.8	4.4	2.4	4.4	3.2	4.4	4.1	4.4	4.6	4.3	7.2
1725	4.8	2.0	4.7	2.6	4.7	3.4	4.7	4.4	4.7	4.9	4.6	7.6

2345B-P

BAR	34		48		69		90		103		172	
RPM	L/m	Kw	L/m	Kw	L/m	Kw	L/m	Kw	L/m	Kw	L/m	Kw
1000	10.6	0.9	10.6	1.1	10.6	1.5	10.6	1.9	10.6	2.1	10.2	3.4
1450	15.5	1.3	15.5	1.6	15.1	2.2	15.1	2.8	15.1	3.1	15.1	4.8
1600	17.0	1.3	16.7	1.8	16.7	2.4	16.7	3.1	16.7	3.4	16.3	5.4
1725	18.2	1.5	17.8	1.9	17.8	2.5	17.8	3.3	17.8	3.7	17.4	5.7

2359B-P, 2359B-PY

PSI	500		700		1000		1300		2000		3000	
RPM	GPM	HP	GPM	HP	GPM	HP	GPM	HP	GPM	HP	GPM	HP
1000	2.1	1.0	2.1	1.6	2.1	2.0	2.1	2.3	2.0	2.8	2.0	4.0
1450	3.0	1.4	3.0	2.3	3.0	2.8	2.9	3.2	2.9	4.1	2.9	5.6
1600	3.3	1.6	3.3	2.6	3.3	3.2	3.3	3.4	3.2	4.4	3.2	6.2
1725	3.6	1.6	3.6	2.7	3.5	3.3	3.5	3.8	3.5	4.8	3.4	6.8

2359B-P, 2359B-PY

BAR	34		48		69		90		138		207	
RPM	L/m	Kw	L/m	Kw	L/m	Kw	L/m	Kw	L/m	Kw	L/m	Kw
1000	7.9	0.7	7.9	1.2	7.9	1.5	7.9	1.7	7.6	2.1	7.6	3.0
1450	11.4	1.0	11.4	1.7	11.4	2.1	11.0	2.4	11.0	3.1	11.0	4.2
1600	12.5	1.2	12.5	1.9	12.5	2.4	12.5	2.5	12.1	3.3	12.1	4.6
1725	13.6	1.2	13.6	2.0	13.2	2.5	13.2	2.8	13.2	3.6	12.9	5.1

2351B-P

PSI	500		700		1000		1300		2000		3000	
RPM	GPM	HP	GPM	HP	GPM	HP	GPM	HP	GPM	HP	GPM	HP
1000	2.4	0.9	2.3	1.7	2.3	2.1	2.3	2.4	2.3	3.1	2.3	4.3
1450	3.4	1.4	3.4	2.4	3.4	3.0	3.3	3.4	3.3	4.4	3.2	6.3
1600	3.8	1.6	3.7	2.7	3.7	3.3	3.7	3.7	3.6	4.8	3.6	7.0
1725	4.0	1.7	4.0	2.9	4.0	3.5	4.0	4.0	3.9	5.1	3.8	7.4

2351B-P

BAR	34		48		69		90		138		207	
RPM	L/m	Kw	L/m	Kw	L/m	Kw	L/m	Kw	L/m	Kw	L/m	Kw
1000	9.1	0.7	8.7	1.3	8.7	1.6	8.7	1.8	8.7	2.3	8.7	3.2
1450	12.9	1.0	12.9	1.8	12.9	2.2	12.5	2.5	12.5	3.3	12.1	4.7
1600	14.4	1.2	14.0	2.0	14.0	2.5	14.0	2.8	13.6	3.6	13.6	5.2
1725	15.1	1.3	15.1	2.2	15.1	2.6	15.1	3.0	14.8	3.8	14.4	5.5

2354B-CP

PSI	500		1000		1500		2000	
RPM	GPM	HP	GPM	HP	GPM	HP	GPM	HP
2800	2.4	1.3	2.3	2.0	2.3	2.7	2.2	3.4
3000	2.6	1.4	2.5	2.2	2.4	2.9	2.3	3.7
3200	2.7	1.6	2.6	2.4	2.6	3.2	2.5	3.9
3400	2.9	1.6	2.8	2.4	2.7	3.3	2.6	4.0

2354B-CP

BAR	34		69		90		103	
RPM	L/m	Kw	L/m	Kw	L/m	Kw	L/m	Kw
2800	9.1	1.0	8.7	1.5	8.7	2.0	8.3	2.5
3000	9.8	1.0	9.5	1.6	9.1	2.2	8.7	2.8
3200	10.2	1.2	9.8	1.8	9.8	2.4	9.5	2.9
3400	11.0	1.2	10.6	1.8	10.2	2.5	9.8	3.0

FORGED BRASS HEAD, DUPLEX PLUNGER PUMPS

Series 2200B-P

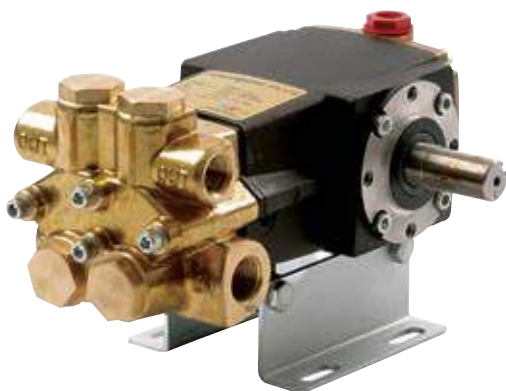

HEAD

- ◆ Single-piece forged brass heads
- ◆ Quick and easy pump packing replacement
- ◆ Precision-machined stainless steel valve and seats provide higher resistance to chemical attack
- ◆ 100% ceramic plungers
- ◆ Dual low pressure packing design for improved priming capabilities
- ◆ Lifetime warranty on single-piece forged brass heads

BODY

- ◆ Hypro's state-of-the-art, patented cartridge technology allows the crankcase oil seals and all wet-end seals to be easily serviced by removing only the pump head
- ◆ Hardened stainless steel lower plungers offer superior corrosion and wear resistance
- ◆ Shafts Output:
 - 3/4" OD Solid Shaft - 2220B-P, 2221B-P, 2230B-P, 2231B-P
 - 5/8" ID Hollow Shaft with Torque Arm - 2220B-HP, 2221B-HP, 2230B-HP, 2231B-HP
 - 5/8" ID Hollow Shaft for direct couple to electric motors (NEMA 56C) - 2220B-AP, 2221B-AP, 2230B-AP, 2231B-AP
 - 3/4" ID Hollow Shaft Flanged for direct couple to gasoline engines - 2231B-CP
- ◆ Heavy-duty oil seals
- ◆ O-ring sealed dipstick
- ◆ Includes rail mounting kit
- ◆ 5-year warranty on material & workmanship

ORDER INFORMATION

2220B-P, 2221B-P, 2230B-P, 2231B-P

Model Number	Max. GPM	Max. PSI	Max. RPM	Inlet Port	Outlet Port
2220B-P	2.1	2000	1725	1/2"	3/8"
2221B-P	2.1	1500	3450	1/2"	3/8"
2230B-P	3.0	2000	1725	1/2"	3/8"
2231B-P	3.0	1500	3450	1/2"	3/8"

Left-hand shaft extension - add suffix "L" - (i.e. 2220B-LP)

ORDER INFORMATION

2220B-HP, 2221B-HP, 2230B-HP, 2231B-HP

Model Number	Max. GPM	Max. PSI	Max. RPM	Inlet Port	Outlet Port
2220B-HP	2.1	2000	1725	1/2"	3/8"
2221B-HP	2.1	1500	3450	1/2"	3/8"
2230B-HP	3.0	2000	1725	1/2"	3/8"
2231B-HP	3.0	1500	3450	1/2"	3/8"

Left-hand shaft extension - add suffix "L" - (i.e. 2220B-HLP)

ORDER INFORMATION

2220B-AP, 2221B-AP, 2230B-AP, 2231B-AP

Model Number	Max. GPM	Max. PSI	Max. RPM	Inlet Port	Outlet Port
2220B-AP	2.1	2000	1725	1/2"	3/8"
2221B-AP	2.1	1500	3450	1/2"	3/8"
2230B-AP	3.0	2000	1725	1/2"	3/8"
2231B-AP	3.0	1500	3450	1/2"	3/8"

Left-hand shaft extension - add suffix "L" - (i.e. 2220B-ALP)

ORDER INFORMATION 2231B-CP

Model Number	Max. GPM	Max. PSI	Max. RPM	Inlet Port	Outlet Port
2231B-CP	3.0	1500	3450	1/2"	3/8"

Left-hand shaft extension - add suffix "L" - (i.e. 2231B-CLP)

FORGED BRASS HEAD, DUPLEX PLUNGER PUMPS

Series 2200B-P

2220B-P, 2220B-AP, 2220B-HP U.S. UNITS

PSI	500			700			1000			1300			1500			2000		
	RPM	GPM	HP	GPM	HP	GPM	HP	GPM	HP	GPM	HP	GPM	HP	GPM	HP	GPM	HP	
1000	1.2	0.5	1.2	0.7	1.2	0.9	1.2	1.1	1.2	1.2	1.2	1.2	1.2	1.6				
1450	1.7	0.8	1.7	1.0	1.7	1.4	1.7	1.6	1.7	1.8	1.7	1.8	1.7	2.3				
1600	1.9	0.9	1.9	1.1	1.9	1.5	1.9	1.8	1.9	2.1	1.9	2.1	1.9	2.7				
1725	2.1	0.8	2.1	1.1	2.1	1.5	2.0	1.9	2.0	2.1	2.0	2.1	2.0	2.9				

2221B-P, 2221B-AP, 2221B-HP

PSI	500			700			1000			1300			1500		
	RPM	GPM	HP	GPM	HP	GPM	HP	GPM	HP	GPM	HP	GPM	HP	GPM	HP
1800	1.2	0.8	1.2	0.9	1.1	1.1	1.1	1.3	1.1	1.5					
2600	1.7	1.1	1.7	1.4	1.6	1.5	1.6	1.9	1.6	2.2					
2875	1.8	1.3	1.8	1.5	1.8	1.8	1.8	2.3	1.7	2.5					
3450	2.1	1.6	2.1	1.9	2.1	2.1	2.1	2.6	2.0	2.9					

2230B-P, 2230B-AP, 2230B-HP

PSI	500			700			1000			1300			1500			2000		
	RPM	GPM	HP	GPM	HP	GPM	HP	GPM	HP	GPM	HP	GPM	HP	GPM	HP	GPM	HP	
1000	1.9	0.8	1.9	1.0	1.9	1.3	1.8	1.7	1.8	1.9	1.8	1.9	1.8	2.4				
1450	2.7	1.1	2.7	1.4	2.7	2.0	2.7	2.4	2.7	2.8	2.7	2.8	2.7	3.6				
1600	3.0	1.2	3.0	1.6	3.0	2.3	3.0	2.8	2.9	3.1	2.9	3.1	2.9	4.1				
1725	3.2	1.4	3.2	1.9	3.2	2.4	3.1	3.0	3.1	3.4	3.1	3.4	3.1	4.4				

2231B-P, 2231B-AP, 2231B-HP, 2231B-CP

PSI	500			700			1000			1300			1500		
	RPM	GPM	HP	GPM	HP	GPM	HP	GPM	HP	GPM	HP	GPM	HP	GPM	HP
1800	1.8	0.8	1.8	1.0	1.8	1.4	1.7	1.7	1.7	1.7	1.9				
2600	2.5	1.2	2.5	1.5	2.5	2.0	2.5	2.4	2.5	2.7					
2875	2.8	1.2	2.8	1.6	2.7	2.1	2.7	2.7	2.7	2.9					
3450	3.2	1.5	3.2	1.9	3.2	2.5	3.2	3.2	3.1	3.5					

2220B-P, 2220B-AP, 2220B-HP METRIC UNITS

BAR	34		48		69		90		103		138	
	RPM	L/m	Kw	L/m	Kw	L/m	Kw	L/m	Kw	L/m	Kw	L/m
1000	4.5	0.4	4.5	0.5	4.5	0.7	4.5	0.8	4.5	0.9	4.5	1.2
1450	6.4	0.6	6.4	0.7	6.4	1.0	6.4	1.2	6.4	1.3	6.4	1.7
1600	7.2	0.7	7.2	0.8	7.2	1.1	7.2	1.3	7.2	1.6	7.2	2.0
1725	7.9	0.6	7.9	0.8	7.9	1.1	7.6	1.4	7.6	1.6	7.6	2.2

2221B-P, 2221B-AP, 2221B-HP

BAR	34		48		69		90		103	
	RPM	L/m	Kw	L/m	Kw	L/m	Kw	L/m	Kw	L/m
1800	4.5	0.6	4.5	0.7	4.2	0.8	4.2	1.0	4.2	1.1
2600	6.4	0.8	6.4	1.0	6.1	1.1	6.1	1.4	6.1	1.6
2875	6.8	1.0	6.8	1.1	6.8	1.3	6.8	1.7	6.4	1.9
3450	7.9	1.2	7.9	1.4	7.9	1.6	7.9	1.9	7.6	2.2

2230B-P, 2230B-AP, 2230B-HP

BAR	34		48		69		90		103		138	
	RPM	L/m	Kw	L/m	Kw	L/m	Kw	L/m	Kw	L/m	Kw	L/m
1000	7.2	0.6	7.2	0.7	7.2	1.0	6.8	1.3	6.8	1.4	6.8	1.8
1450	10.2	0.8	10.2	1.0	10.2	1.5	10.2	1.8	10.2	2.1	10.2	2.7
1600	11.4	0.9	11.4	1.2	11.4	1.7	11.4	2.1	11.0	2.3	11.0	3.1
1725	12.1	1.0	12.1	1.4	12.1	1.8	11.7	2.2	11.7	2.5	11.7	3.3

2231B-P, 2231B-AP, 2231B-HP, 2231B-CP

BAR	34		48		69		90		103	
	RPM	L/m	Kw	L/m	Kw	L/m	Kw	L/m	Kw	L/m
1800	6.8	0.6	6.8	0.7	6.8	1.0	6.4	1.3	6.4	1.4
2600	9.5	0.9	9.5	1.1	9.5	1.5	9.5	1.8	9.5	2.0
2875	10.6	0.9	10.6	1.2	10.2	1.6	10.2	2.0	10.2	2.2
3450	12.1	1.1	12.1	1.4	12.1	1.9	12.1	2.4	11.7	2.6

BIG TWIN

Models 5206C and 5206C-H



- ◆ Port sizes: 3/4" inlet, 3/4" outlet
- ◆ Max. fluid temperature: 140°F/60°C
- ◆ Pump shaft rotation: bi-rotational
- ◆ Cups: Leather standard [fabric-reinforced (F) and Buna-N (R) available]
- ◆ Recommended to be used with Pulsation Dampener 3375-0017-2
- ◆ Weight: 18 lbs./8.2 kg

ORDER INFORMATION

Model Number	Max GPM	Max LPM	Max PSI	Max BAR	Max RPM	Shaft Output
5206C	8	30.3	400	27.6	800	1" solid shaft w/base
5206C-H	8	30.3	400	27.6	800	1-3/8" hollow shaft w/base
3430-0037	Leather cup kit					

Fabric Cups - Add Suffix "F" - (ie.: 5206C-F).
Buna-N Cups - Add Suffix "R" - (ie.: 5206C-R).

Pressure in PSI and BAR	GPM	HP	GPM	HP	GPM	HP	GPM	HP	GPM	HP	GPM	HP
	LPM	HP	LPM	HP	LPM	HP	LPM	HP	LPM	HP	LPM	HP
	@400 RPM		@500 RPM		@540 RPM		@600 RPM		@700 RPM		@800 RPM	
25 PSI	3.9	.26	4.9	.29	5.4	.31	6.0	.34	7.0	.40	8.0	.46
1.7 BAR	14.8	.26	18.5	.29	20.4	.31	22.7	.34	26.5	.40	30.3	.46
100 PSI	3.9	.40	5.0	.46	5.4	.50	6.0	.56	7.0	.65	7.9	.74
6.9 BAR	14.8	.40	18.9	.46	20.4	.50	22.7	.56	26.5	.65	29.9	.74
200 PSI	4.0	.66	5.0	.75	5.4	.81	6.0	.90	6.9	1.1	7.8	1.2
13.8 BAR	15.1	.66	18.9	.75	20.4	.81	22.7	.90	26.1	1.1	29.5	1.2
300 PSI	3.9	.89	5.0	1.1	5.3	1.2	5.9	1.3	6.9	1.5	7.7	1.7
20.9 BAR	14.8	.89	18.9	1.1	20.1	1.2	22.3	1.3	26.1	1.5	29.1	1.7
400 PSI	3.9	1.1	4.9	1.4	5.3	1.5	5.9	1.6	6.9	1.9	7.7	2.2
27.6 BAR	14.8	1.1	18.5	1.4	20.1	1.5	22.3	1.6	26.1	1.9	29.1	2.2

BIG TWIN

Models 5210C and 5210C-H



- ◆ Port sizes: 3/4" inlet, 3/4" outlet
- ◆ Max. fluid temperature: 140°F/60°C
- ◆ Pump shaft rotation: bi-rotational
- ◆ Cups: Leather standard [fabric-reinforced (F) and Buna-N (R) available]
- ◆ Recommended to be used with Pulsation Dampener 3375-0015-2
- ◆ Weight: 18 lbs./8.2 kg

ORDER INFORMATION

Model Number	Max GPM	Max LPM	Max PSI	Max BAR	Max RPM	Shaft Output
5210C	10	37.5	400	27.6	600	1" solid shaft w/base
5210C-H	10	37.5	400	27.6	600	1-3/8" hollow shaft w/base
3430-0037	Leather cup kit					

Fabric Cups - Add Suffix "F" - (ie.: 5210C-F).
Buna-N Cups - Add Suffix "R" - (ie.: 5210C-R).

Pressure in PSI and BAR	GPM	HP	GPM	HP	GPM	HP	GPM	HP
	LPM	HP	LPM	HP	LPM	HP	LPM	HP
	@400 RPM		@500 RPM		@540 RPM		@600 RPM	
25 PSI	7.3	.39	8.9	.57	9.4	.66	10.0	.73
1.7 BAR	27.6	.39	33.7	.57	35.6	.66	37.9	.73
100 PSI	7.3	.69	8.9	.87	9.4	.94	9.9	1.10
6.9 BAR	27.6	.69	33.7	.87	35.6	.94	37.5	1.10
200 PSI	7.2	1.2	8.8	1.5	9.3	1.6	9.9	1.7
13.8 BAR	27.2	1.2	33.3	1.5	35.2	1.6	37.5	1.7
300 PSI	7.2	1.7	8.8	2.0	9.3	2.2	9.8	2.3
20.7 BAR	27.2	1.7	33.3	2.0	35.2	2.2	37.1	2.3
400 PSI	7.2	2.1	8.7	2.6	9.2	2.7	9.8	3.0
27.6 BAR	27.2	2.1	32.9	2.6	34.8	2.7	37.1	3.0

SMALL TWIN

Series 5315, 5320, 5325 and 5330



- ◆ Port sizes: 1/2" inlet, 1/2" outlet
- ◆ Max. fluid temperature: 140°F/60°C
- ◆ Pump shaft rotation: bi-rotational
- ◆ Cups: Leather (-X) standard for 5300 Series [Buna-N (-RX), Teflon (-CX) available]
- ◆ Models require a pulsation dampener (such as a 3375-0012 pulse hose) on the discharge side
- ◆ Injector head available (sold separately part number 3396-0014)
- ◆ Weight: 10 lbs./4.5 kg

ORDER INFORMATION

Model Number	Max GPM	Max LPM	Max PSI	Max BAR	Max RPM	Shaft Output
5315C-X	1.5	5.7	500	34.5	1800	5/8" OD solid shaft
5320C-X	2.2	8.3	500	34.5	1800	5/8" OD solid shaft
5325C-X	2.5	9.5	500	34.5	1800	5/8" OD solid shaft
5330C-X	3	11.4	500	34.5	1800	5/8" OD solid shaft
5315C-HX	1.5	5.7	500	34.5	1800	5/8" ID hollow shaft
5320C-HX	2.2	8.3	500	34.5	1800	5/8" ID hollow shaft
5325C-HX	2.5	9.5	500	34.5	1800	5/8" ID hollow shaft
5330C-HX	3	11.4	500	34.5	1800	5/8" ID hollow shaft

Buna-N - add suffix "R" - (i.e :5320C-RX)
 Teflon - add suffix "C" - (i.e :5320C-CX)

Model	5315		5320		5325		5330	
	GPM	HP	GPM	HP	GPM	HP	GPM	HP
	LPM	HP	LPM	HP	LPM	HP	LPM	HP
Pressure in PSI and BAR	@1725 RPM		@1725 RPM		@1725 RPM		@1725 RPM	
50 PSI	1.56	.12	2.22	.21	2.56	.25	3.02	.37
3.4 BAR	5.9	.12	8.4	.21	9.7	.25	11.4	.37
100 PSI	1.52	.15	2.18	.28	2.54	.37	3.01	.49
6.9 BAR	5.8	.15	8.3	.28	9.6	.37	11.4	.49
200 PSI	1.50	.28	2.16	.43	2.52	.52	3.00	.74
13.8 BAR	5.7	.28	8.2	.43	9.3	.52	11.4	.74
300 PSI	1.47	.35	2.12	.57	2.50	.68	2.98	.92
20.7 BAR	5.6	.35	8.0	.57	9.5	.68	11.3	.92
400 PSI	1.45	.43	2.11	.71	2.10	.82	2.96	1.11
27.6 BAR	5.5	.43	8.0	.71	7.9	.82	11.2	1.11
500 PSI	1.44	.56	2.10	.83	2.44	.96	2.94	1.23
34.5 BAR	5.5	.56	7.9	.83	9.9	.96	11.1	1.23

SMALL TWIN

Models 5324C and 5324C-H



- ◆ Port sizes: 1/2" inlet, 1/2" outlet
- ◆ Max. fluid temperature: 140°F/60°C
- ◆ Pump shaft rotation: bi-rotational
- ◆ Cups: Buna-N standard
- ◆ Model 5324 requires a pulsation dampener (such as a 3375-0012 pulse hose) on the discharge side
- ◆ Injector head available 3396-0006
- ◆ Weight: 11 lbs./5 kg

Pressure in PSI and BAR	GPM	HP	GPM	HP	GPM	HP	GPM	HP	GPM	HP
	LPM	HP	LPM	HP	LPM	HP	LPM	HP	LPM	HP
	@600 RPM		@900 RPM		@1200 RPM		@1450 RPM		@1725 RPM	
100 PSI	.96	.12	1.51	.19	2.00	.28	2.42	.34	2.90	.40
6.9 BAR	3.6	.12	5.7	.19	7.6	.28	9.2	.34	11.0	.40
200 PSI	.94	.19	1.49	.30	1.98	.41	2.40	.50	2.89	.59
13.8 BAR	3.6	.19	5.6	.30	7.5	.41	9.1	.50	10.9	.59
300 PSI	.94	.26	1.48	.41	1.97	.55	2.38	.67	2.87	.80
20.7 BAR	3.6	.26	5.6	.41	7.5	.55	9.0	.67	10.9	.80
400 PSI	.95	.33	1.47	.50	1.96	.67	2.37	.83	2.85	1.00
27.6 BAR	3.6	.33	5.6	.50	7.4	.67	9.0	.83	10.8	1.00
500 PSI	.94	.39	1.47	.60	1.96	.81	2.36	.97	2.83	1.19
34.5 BAR	3.6	.39	5.6	.60	7.4	.81	8.9	.97	10.7	1.19
600 PSI	.93	.45	1.46	.69	1.95	.93	2.35	1.13	2.81	1.38
41.4 BAR	3.5	.45	5.5	.69	7.4	.93	8.9	1.13	10.6	1.38
700 PSI	.93	.52	1.46	.78	1.94	1.06	2.33	1.27	2.80	1.54
48.3 BAR	3.5	.52	5.5	.78	7.3	1.06	8.8	1.27	10.6	1.54
800 PSI	.93	.58	1.45	.87	1.93	1.16	2.32	1.42	2.79	1.69
55.2 BAR	3.5	.58	5.5	.87	7.3	1.16	8.8	1.42	10.6	1.69

ORDER INFORMATION

Model Number	Max GPM	Max LPM	Max PSI	Max BAR	Max RPM	Shaft Output
5324C	2.9	11.0	800	55.2	1800	5/8" OD solid shaft
5324C-H	2.9	11.0	800	55.2	1800	5/8" ID hollow shaft

SMALL TWIN

Models 5321C, 5322C, 5321C-H and 5322C-H



- ◆ Port sizes: 1/2" inlet, 1/2" outlet
- ◆ Max. fluid temperature: 180°F/82°C
- ◆ Pump shaft rotation: bi-rotational
- ◆ Injector head available 3396-0006
- ◆ Models 5321 and 5322 require a pulsation dampener (such as a 3375-0012 pulse hose) on the discharge side
- ◆ Weight: 11 lbs./5 kg

ORDER INFORMATION

Model Number	Max GPM	Max LPM	Max PSI	Max BAR	Max RPM	Shaft Output	Plunger Material
5321C	2.2	8.3	1000	68.9	1800	5/8" OD solid shaft	Stainless Steel
5322C	2.2	8.3	1000	68.9	1800	5/8" OD solid shaft	Ceramic
5321C-H	2.2	8.3	1000	68.9	1800	5/8" ID hollow shaft	Stainless Steel
5322C-H	2.2	8.3	1000	68.9	1800	5/8" ID hollow shaft	Ceramic

Pressure in PSI and BAR	GPM	HP	GPM	HP	GPM	HP	GPM	HP
	LPM	HP	LPM	HP	LPM	HP	LPM	HP
	@900 RPM		@1200 RPM		@1450 RPM		@1725 RPM	
100 PSI	1.1	0.2	1.5	.3	1.8	.4	2.2	.4
6.9 BAR	4.2	0.2	5.7	.3	6.8	.4	8.3	.4
300 PSI	1.1	.4	1.5	.5	1.8	.6	2.1	.7
20.7 BAR	4.2	.4	5.7	.5	6.8	.6	7.9	.7
500 PSI	1.1	.5	1.5	.6	1.8	.7	2.1	.8
34.5 BAR	4.2	.5	5.7	.6	6.8	.7	7.9	.8
700 PSI	1.1	.6	1.5	.8	1.8	.9	2.1	1.1
48.3 BAR	4.2	.6	5.7	.8	6.8	.9	7.9	1.1
1000 PSI	1.1	.8	1.4	1.0	1.8	1.2	2.1	1.4
69.0 BAR	4.2	.8	5.3	1.0	6.8	1.2	7.9	1.4

SMALL TWIN

Model 53702



- ◆ Port sizes: 1/2" inlet, 1/2" outlet
- ◆ Max. fluid temperature: 180°F/82°C
- ◆ Pump shaft rotation: bi-rotational
- ◆ Plungers: polished ceramic
- ◆ Model 53702 requires a pulsation dampener (such as a 3375-0012 pulse hose) on the discharge side
- ◆ Inlet requirements: pressure feed 20-100 psi (1.4-6.9 bar)
- ◆ Weight: 11 lbs./5 kg

ORDER INFORMATION

Model Number	Max GPM	Max LPM	Max PSI	Max BAR	Max RPM	Shaft Output
53702	2.2	8.3	1000	68.9	3450	5/8" ID hollow shaft

Pressure in PSI and BAR	GPM	HP
	LPM	HP
	@3450 RPM	
100 PSI	2.3	.4
6.9 BAR	8.7	.4
300 PSI	2.2	.7
20.7 BAR	8.3	.7
500 PSI	2.1	.9
34.5 BAR	8.0	.9
700 PSI	2.1	1.2
48.3 BAR	8.0	1.2
1000 PSI	2.0	1.5
69 BAR	7.6	1.5

SMALL TWIN

Model 53703



- ◆ Max. fluid temperature: 180°F/82°C
- ◆ Port sizes: 1/2" inlet, 1/2" outlet
- ◆ Pump shaft rotation: bi-rotational
- ◆ Plungers: polished ceramic
- ◆ Model 53703 requires a pulsation dampener (such as a 3375-0012 pulse hose) on the discharge side
- ◆ Inlet requirements: pressure feed 20-100 psi (1.3 - 6.9 bar)
- ◆ Weight: 11 lbs./5 kg

ORDER INFORMATION

Model Number	Max GPM	Max LPM	Max PSI	Max BAR	Max RPM	Shaft Output
53703	2.3	8.7	1000	68.9	3100	5/8" ID hollow shaft

Requires a Special Order Gas Engine With 5/8" Shaft

Pressure in PSI and BAR	GPM	HP
	LPM	HP
	@3100 RPM	
100 PSI	2.3	0.4
6.9 BAR	8.7	0.4
300 PSI	2.2	.7
20.7 BAR	8.3	.7
500 PSI	2.1	.9
34.5 BAR	7.9	.9
700 PSI	2.1	1.2
48.3 BAR	7.9	1.2
1000 PSI	2.0	1.5
69.0 BAR	7.6	1.5

HYDRAULICALLY-DRIVEN PRESSURE WASHERS

Offering 3-4 gpm (11-15 lpm) Cleaning Power



- ◆ Anodized, die-cast aluminum crankcase
- ◆ Heavy-duty, corrosion-resistant brass manifold
- ◆ One-piece, forged-bronze connecting rods
- ◆ Stainless steel valves
- ◆ Hardened, stainless steel piston guides
- ◆ Solid ceramic plungers
- ◆ High pressure and low pressure packings of high-quality buna textile
- ◆ Heavy-duty, ball bearing supported crankshaft
- ◆ Sight glass and oil-level dipstick
- ◆ Hydraulic ports: 1/2" NPT inlet, 3/4" NPT outlet

The hydraulically-driven pressure washers are ideally suited for remote and explosion-proof environments where electricity cannot be used. These models are equipped with a hydraulic motor-driven, triplex plunger pump; and include an unloader, gauge, and quick disconnect. Some models include a chemical injector, 50' (15 m) pressure wash hose, trigger gun and insulated wand with adjustable Hi-Lo and Variable-Angle cleaning nozzle. Certain models are also equipped with a chemical injector.

Model Number	Max GPM	Max LPM	Max PSI	Max BAR	Hydraulic Motor Requirements				Description	Weight	
					GPM	LPM	PSI	BAR		LBS	KG
1802C*	3	11.4	1000	68.9	5	18.9	1300	89.6	Forged Brass Head Triplex Pumps with hydraulic motor, adjustable unloader, gauge, 1/2" NPT input, 3/8" quick disconnect output	38	17.2
1803C	3	11.4	1000	68.9	5	18.9	1300	89.6		28	12.7
1804C*	3	11.4	1500	103.4	8	30.3	1900	131	Forged Brass Head Triplex Pumps with hydraulic motor, chemical injector, adjustable unloader, gauge, 3/4" GH input, 3/8" quick disconnect output	41	18.6
1805C	3	11.4	1500	103.4	8	30.3	1900	131		26	11.8
1806C*	3	11.4	2000	137.9	11	41.6	1300	89.6		41	18.6
1807C	3	11.4	2000	137.9	11	41.6	1300	89.6		26	11.8
1824C*	4	15.1	1500	103.4	8.5	32.2	2000	137.9		49	22.2
1825C	4	15.1	1500	103.4	8.5	32.2	2000	137.9		33	14.9
1826C*	4	15.1	2000	137.9	8.5	32.2	2000	137.9		49	22.2
1827C	4	15.1	2000	137.9	8.5	32.2	2000	137.9		33	14.9

* Includes 50 ft (15 m) hose and gun assembly

PISTON/PLUNGER ACCESSORIES

PRESSURE-ACTIVATED 3 PORT UNLOADERS



Model Number	Inlet/ Outlet	Bypass	Pressure Range		Max GPM	Max LPM	Max Temp	Max Temp	Cup Material	Ref #
			PSI	Bar						
3390-0062D*	3/8" (M)NPT	1/4" (F) NPT	200-600	14-41	5	19	180° F	82° C	Buna-N	1
3390-0063D*			400-1000	28-69						
3390-0071D* ^T			400-1000	28-69						
3390-0067D*			800-1500	55-103						
3390-0072D* ^T			800-1500	55-103						
3390-0006	1/2" (F)NPT	1/2" (F) NPT	200-500	14-34	5	19	160° F	71° C	Buna-N	2
3390-0007			200-500	14-34					Leather	
3390-0037			300-1000	21-69					Buna-N/Teflon	

* Recommended for use with 5300 Series pumps

^T For close-coupled bypass operation with Hypro 2200 and 2300 Series PowerLine Plus pumps, bypass not NPT. Use only with 8000-0007 and 80000-0006.



PRESSURE-ACTIVATED 3 OR 5 PORT UNLOADERS WITH ADJUSTMENT KNOB

Model Number	# of Ports	Inlet/ Outlet	Bypass	Max PSI	Max Bar	Max GPM	Max LPM	Max Temp	Max Temp	Cup Material	Ref #
3390-0079	3	3/8" (M)NPT	3/8" (F) NPT	2000	138	8	30	200° F	93° C	Buna-N	1
3390-0102	3	3/8" (M)NPT	1/4" (F)NPT	2600	179						2
3390-0076	3	3/8" (F)NPT	3/8" (F)NPT	4500	248						3
3390-0081	5	(2) 3/8" (F)NPT x 3/8" (F)NPT	(2) 1/4" (F)NPT	3600	248						4

PRESSURE-ACTIVATED UNLOADER/BYPASS KITS



Model Number	Inlet/Outlet	Pressure Range		Max GPM	Max LPM	Max Temp	Max Temp	Description
		PSI	Bar					
8000-0007	1/2" (F)NPT x 3/8" (M)NPT	400-1000	28-69	5	19	200° F	93° C	3 port unloader/bypass system with adjustable knob for 2200 and 2300 series PowerLine Plus Pumps.
8000-0008		800-1500	55-103					

CLOSED-COUPLED UNLOADERS



Model Number	Inlet/Outlet	Max PSI	Max Bar	Max GPM	Max LPM	Injector Orifice Range		Max Temp	Max Temp	Description
						GPM	LPM			
3390-0104-3A	1/2" (F)NPT x 3/8" (M)NPT	2600	180	8	30	2.0-3.2	7.6-12.1	200° F	93° C	2 port unloader/bypass system with built-in chemical injector and adjustable knob.

For 2200 & 2300 series PowerLine Plus pumps.

ADJUSTABLE & FIXED CHEMICAL INJECTORS



Model Number	Inlet/Outlet	Max PSI	Max Bar	GPM Range	LPM Range	Max Temp	Max Temp	Type	Materials	Ref #
3396-0034/1.8	3/8" (F)NPT x 3/8" (M)NPT	3200	220	0-2.9	0-11	200° F	93° C	Fixed	Forged brass body; Stainless Steel Ball & Spring	1
3396-0031/2.1				3.0-4.0	11-15			Adjustable		2
3396-0033/2.3				4.0-5.0	15-19			Fixed		1



POWER ADJUSTABLE INJECTOR FOR 2200/2300 PUMPS

Model Number	Inlet	Max PSI	Max Bar	GPM Range	LPM Range	Max Temp	Max Temp	Materials	For Models	Description
3396-0011	1/8" (F) NPT	1500	103	2.0-4.8	7.5-18	140° F	60° C	Brass & Stainless Steel	2200 & 2300	9-step calibrated metering
3396-0025		3000	207			160° F	71° C		2200B-P & 2300B-P	



POWER ADJUSTABLE INJECTOR FOR 5300 PUMP

Model Number	Inlet	Max PSI	Max Bar	GPM Range	LPM Range	Max Temp	Max Temp	Description	Materials	For Models
3396-0014	1/8" (F) NPT	500	34	1.5-3.0	5.7-11	140° F	60° C	9-step adjustable, needle-type metering assembly for precise metering of soaps and liquids	Cast iron cylinder head; brass and stainless steel internal components	5300CX
3396-0006		1000	69	2	7.5					5321 & 5342C

Replaces standard head on Series 5300 and 5321 pumps



REGULATOR/RELIEF VALVE - PROVIDES SMOOTH, CONSTANT PRESSURE REGULATION

Model Number	Inlet/Outlet	Max PSI	Max Bar	Balanced Pressure		Max GPM	Max LPM	Max Temp	Max Temp	Materials
				PSI	Bar					
3300-0084	3/8" (F) NPT	2000	138	200-2000	14-138	7	26	160° F	71° C	Brass Body; Stainless Steel plunger & seat



HIGH FLOW PRESSURE REGULATOR/RELIEF VALVE FOR 2535S & 2545S PUMPS

Model Number	Inlet/Outlet	Max PSI	Max Bar	Balanced Pressure		Max GPM	Max LPM
				PSI	Bar		
3300-0102	3/4" x 1/2"	2000	138	260-2000	18-138	53	200
3300-0103	1" x 1"						

THERMAL RELIEF VALVE

Easy mount valve to safeguard pumps from damaging heat generated within recirculating water systems. Easy to service without removing.



Model Number	Inlet	Max PSI	Max Bar	Relief Temp	Relief Temp	Materials	Dimensions
3312-0004	1/2" (M) NPT	200	14	145° F	63° C	Brass, Stainless Steel & Buna-N	1-1/16" Hex x 1-11/16"
3312-0005*							1-1/16" Hex x 2-1/2"

* 3/16" barb fittings

SCREW COUPLINGS & CONNECTING NIPPLES



Model Number		Inlet	Max PSI	Max Bar	Max GPM	Max LPM	Max Temp	Max Temp
Screw Couplings	Connecting Nipples							
3341-0001	3341-0005	3/8" (F) NPT	3500	241	12	45	300° F	149° C
3341-0002	3341-0006	1/4" (F) NPT						
3341-0003	3341-0007	3/8" (M) NPT						
3341-0004	3341-0008	1/4" (M) NPT						

PISTON/PLUNGER ACCESSORIES



C-FLANGE KITS

Model Number	Fits Motor	For Models
8000-0003	NEMA 56C, 143TC and 145TC	2200, 2300, 2350
8000-0010	NEMA 182TC and 184TC	2200, 2300, 2350
8000-0043	NEMA 213TC and 215TC	2200B-P & 2300B-P
8000-0017	NEMA 213TC and 215TC	2400 & 2430
8000-0018	NEMA 182TC and 184TC	2400 & 2430

PULSATION DAMPENERS

These quality-built pulsation dampeners protect your system from damage due to pulsation and vibration. Choose the size and capacity that meets your system's needs. In most applications, the recommended dampener charge is 1/2 of the operating pressure with a 2-piston pump and 2/3 of the operating pressure with a 3-piston pump.



Model Number	Inlet	Charge PSI	Charge Bar	Max GPM	Max LPM	For Models	Ref #
3375-0015-x	1" (F)NPT	200-1000	14-69	35	132	2500 Series	1
3375-0017-x	1/2" (F)NPT			6	23	2000 Series	2

Note: Replace 'x' with maximum charge designation; Example: 3375-0015-8 = 800 psi, 3375-0017-7 = 700 psi
Available in 100 psi increments from 200 psi to 1000 psi.

PULSATION DAMPENER CHECKER

For testing the charge pressure in pulsation dampeners. The proper charge will ensure maximum life and performance of pressure systems.



Model Number	Connection	Max PSI	Max Bar
2642-0001	5/16" 32 UNEF (F) Thread	2000	138

PULSE HOSES

Quality pulsation dampener hoses constructed of special Hi-Flex horizontally-braided hose.



Model Number	Length	Max PSI	Max Bar	Connection
3375-0008	24" (61 cm)	1500	103	3/8" (F)NPT x 3/8" (M)NPT
3375-0012	24" (61 cm)			3/8" (F)NPT x plugged end
3375-0021	25" (63.5 cm)			1/4" (M)NPT x plugged end

GEAR BOXES



Model Number	Inlet/Outlet	Max PSI	Max Bar	Max Temp	Max Temp	Description	Materials
8000-0015	3/8" (F)NPT x 3/8" (M)NPT	3200	220	200° F	93° C	1.8:1 gearbox kit for mounting 10 hp-18 hp gas engines with 1-1/8" solid shaft (Kohler engines)	Forged brass body; Stainless steel ball and spring
8000-0021						1.8:1 gearbox kit for mounting 8 hp-18 hp gas engines with 1" solid shaft (B&S and Honda engines)	

PISTON/PLUNGER ACCESSORIES



ZINC-PLATED STEEL PORT ADAPTERS

Model Number	Port Openings			
	1 - End	2 - Gauge Port	3 - Side	4 - End
2404-0030	1/2" (M)NPT	1/4" (F)NPT	1/2" (F)NPT	1/2" (F)NPT
2404-0019	3/4" (M)NPT	1/4" (F)NPT	1/2" (F)NPT	3/4" (F)NPT



FLOAT TANK STRAINER

Model Number	Tank Outlet Filter	Outlet
3800-0074	1/2"	1/2" (M)NPT



VACUUM SWITCHES

Model Number	Performance	Max Temp	Max Temp
2510-0001	VAC-ON: 1.5 Hg vac.	140° F	60° C
2510-0007	VAC-ON: 2.5 Hg vac.		
2510-0017	VAC-ON: 4.5 Hg vac.		

FEATURES

- ◆ Switches can be used with either AC or DC motors in the ratings shown
 - DC (32-115-230V): up to 1/2 hp
 - Single or 3 Phase at 110V: up to 2 hp 220V: up to 2 hp
- ◆ VAC-ON switch automatically shuts off motor when liquid is depleted or vacuum drops to a specific level



PUMP OIL

Model Number	Size	Descriptions
2160-0038	1 qt. (12 per carton)	Specially-formulated pump oil
2160-0047	1 gallon (bulk)	
2160-0048	2-1/2 gallon (bulk)	

FEATURES:

- ◆ Reduces scuff and wear in piston and plunger pumps
- ◆ Inhibits moisture that causes damage
- ◆ Prevents oxidation that could lead to sludge formation
- ◆ Resists foaming and aeration that can cause equipment to operate erratically and oil to oxidize
- ◆ Provides smooth pump operation in a variety of temperatures



PRESSURE SWITCH

Model Number	Inlet	Max PSI	Max Bar	Max Temp	Max Temp	Voltage	Max Amp Vertical and Horizontal Mount
2510-0029	3/8" (M)NPT	3500	241	200° F	93° C	12-250V	15A

PISTON/PLUNGER ACCESSORIES



FLOAT SWITCH

Model Number	Inlet/Outlet	Max PSI	Max Bar	Max GPM	Max LPM	Max Temp	Max Temp	Voltage	Mount
2510-0030	3/8" (F)NPT x 3/8" (F)NPT	3500	241	7.8	30	180° F	82° C	12-250V	Vertical
2510-0031	3/8" (M)NPT x 3/8" (M)NPT								Horizontal



ALUMINUM LINE STRAINER

Model Number	Inlet/Outlet	Max PSI	Max Bar	Max GPM	Max LPM	Housing Material	Screen Mesh	Bypass Hose Port
3350-0134	1/2" (F)BPS x 1/2" (M)BPS	100	7	8	30	Aluminum	50	G 1/4"



SUCTION STRAINER

Model Number	Size	Opening Size (ID)	Overall Diameter	Screen Mesh	Material
3350-0021	1/4" (ID) plastic tubing	.330"	1.25"	50	Stainless Steel Screen
3350-0022			1"		
3350-0033	5/8" (ID) x 61/64" (OD) garden hose	.940"	2.187"		
3800-0035	(F) garden hose end	.57"	1.016"		



CHEMICAL INJECTOR STRAINER

Model Number	Hose Barb	Material	Check Valve
3350-0126	1/4" & 3/8"	Chemical-resistant plastic body and components	Yes
3350-0127			No
3350-0128	1/4"	Corrosion-resistant stainless steel and brass construction	Yes

COUPLERS



Inches	mm
1/8"	3.2 mm
3/16"	4.7 mm
1/4"	6.4 mm
1/2"	13 mm
5/8"	15.9 mm
3/4"	19 mm
7/8"	22.2 mm
15/16"	23.8 mm
1"	25.4 mm
1-1/8"	28.6 mm

Note:
These couplers are designed for inch dimensional shafts and keys. Metric dimensions are for reference only (except for 2739-1009).

Series	Part Number	Description	Estimated Weight Each	
			US Units	Metric
2738 (2.0 hp limit)*	2738-1001	1/2" coupling end, with 1/8" keyway	6 oz.	170 g
	2738-1002	5/8" coupling end, with 3/16" keyway	6 oz.	170 g
	2738-1003	3/4" coupling end, with 3/16" keyway	6 oz.	170 g
	2738-1004	7/8" coupling end, with 3/16" keyway	6 oz.	170 g
Replaces L-075	2728-1001	Center disc	1 oz.	28 g
2739 (5.0 hp limit)*	2739-1001	5/8" coupling end, with 3/16" keyway	11 oz.	312 g
	2739-1002	3/4" coupling end, with 3/16" keyway	11 oz.	312 g
	2739-1003	7/8" coupling end, with 3/16" keyway	11 oz.	312 g
	2739-1004	15/16" coupling end, with 1/4" keyway	11 oz.	312 g
	2739-1005	1" coupling end, with 1/4" keyway	11 oz.	312 g
	2739-1006	1-1/8" coupling end, with 1/4" keyway	11 oz.	312 g
	2739-1009	24 mm coupling end, with 8mm keyway	11 oz.	312 g
Replaces L-095	2729-1001	Center disc	1 oz.	28 g
2741 (10.5 hp limit)*	2729-1005	Heavy-duty center disc, urethane material	1 oz.	28 g
	2741-1001	3/4" coupling end, with 3/16" keyway	1 lb. 5 oz.	595 g
	2741-1004	15/16" coupling end, with 1/4" keyway	1 lb. 5 oz.	595 g
	2741-1002	1" coupling end, with 1/4" keyway	1 lb. 5 oz.	595 g
	2741-1005	1-1/4" coupling end, with 1/4" keyway	1 lb. 5 oz.	595 g
	2741-1007	1-3/8" coupling end, with 5/16" keyway	1 lb. 5 oz.	595 g
	2741-1003	1-1/8" coupling end, with 1/4" keyway	1 lb. 5 oz.	595 g
	2729-1002	Center disc	1 oz.	28 g
Replaces L-100	2729-1006	heavy-duty center disc, urethane material	1 oz.	28g
2740 (18.0 hp limit)*	2740-1001	3/4" coupling end, with 3/16" keyway	3 lbs. 11 oz.	1.67 kg
	2740-1002	1" coupling end, with 1/4" keyway	3 lbs. 8 oz.	1.59 kg
	2740-1005	1-3/8" coupling end, with 5/16" keyway	3 lbs.	1.4 kg
	2740-1007	1-1/8" coupling end, with 1/4" keyway	2 lbs. 15 oz.	1.33 kg
Replaces L-110	2729-1003	Center disc	3 oz.	85 g

* HP limit is electric motor hp at 1725 rpm for driving a steady uniform load. For an uneven load, stop-start and moderate shock loads, divide hp by a 1.5 service factor.

ORDERING INSTRUCTIONS:

To order one 1/2" x 3/4" Series 2738 coupling, specify the following:

Note: It is not necessary to order in complete sets, parts can be ordered individually.

Quantity	Part Number	Description
1	2738-1001	1/2" coupling end
1	2738-1003	3/4" coupling end
1	2728-1001	Center disc

VERSA-TWIN 2130 SERIES PLUNGER PUMPS



FEATURES

- ◆ Molded from Noryl GTX for chemical resistance against fertilizers, insecticides, chlorides, acids, and bleach
- ◆ Robust motor, ceramic plunger, and crank drive provide market-leading long life without servicing
- ◆ 4-point 1" NPT flynut-ready connections allow for greater flexibility in plumbing, easy installation and servicing, draining and maintenance
- ◆ 1" ports allow for single-sided inlet plumbing
- ◆ Available in standard models up to 4.0 GPM (15.1 L/min) & 300 PSI (20.7 BAR)

ORDER INFORMATION

Model Number	Max GPM	Max L/min	Max PSI	Max BAR	Max RPM	Motor Type	Ports
2130P-D183	2.5	9.5	150	10.3	2200	¼ HP 12V DC Motor, 20 amps	1" MNPT
2130P-D355	2.8	10.6	300	20.7	2000	½ HP 12V DC Motor, 35 amps	
2130P-D359	3.9	14.8	200	13.8	2000	½ HP 12V DC Motor, 35 amps	
2130P-D395	2.9	11.0	300	20.7	2000	½ HP 12V DC Motor, 56C, 39 amps	
2130P-D399	4.0	15.1	200	13.8	2000	½ HP 12V DC Motor, 56C, 39 amps	
2130P-A055	2.4	9.1	300	20.7	1750	½ HP 115-208/230V AC Motor, 1 PH 50/60 Hz	
2130P-A079	3.9	14.8	300	20.7	1750	¾ HP 115-208/230V AC Motor, 1 PH 50/60 Hz	
2130PX	Replacement pump head						

PERFORMANCE

Model Number	0 PSI / 0 BAR		50 PSI / 3.5 BAR		100 PSI / 6.9 BAR		150 PSI / 10.3 BAR		200 PSI / 13.8 BAR		250 PSI / 17.2 BAR		300 PSI / 20.7 BAR	
	GPM	AMPS	GPM	AMPS	GPM	AMPS	GPM	AMPS	GPM	AMPS	GPM	AMPS	GPM	AMPS
	L / min		L / min		L / min		L / min		L / min		L / min		L / min	
2130P-D183 ¹	2.5	5.2	2.2	9.8	2.0	14.6*	1.8	19.3*	-	-	-	-	-	-
	9.5		8.3		7.6		6.8		-		-		-	
2130P-D355 ¹	2.8	9.1	2.5	13.4	2.4	18.9	2.3	23.5	2.2	27.5*	2.1	30.9*	2.0	34.8*
	10.6		9.5		9.1		8.7		8.3		7.9		7.6	
2130P-D359 ¹	3.9	11.6	3.2	17.2	3.1	21.5*	3.0	26.2*	2.8	31.8*	-	-	-	-
	14.8		12.1		11.7		11.4		10.6		-		-	
2130P-D395 ¹	2.9	8.3	2.5	13.0	2.4	19.0	2.3	23.5	2.2	27.2	2.1	30.7	2.0	33.9
	11.0		9.5		9.1		8.7		8.3		7.9		7.6	
2130P-D399 ¹	4.0	11.0	3.5	17.2	3.3	24.0	3.1	29.3	3.0	34.2	-	-	-	-
	15.1		13.2		12.5		11.7		11.4		-		-	
2130P-A055 ²	2.4	6.5	2.2	6.6	2.1	6.7	2.1	6.8	2.0	7.0	1.9	7.2	1.9	7.3
	9.1		8.3		7.9		7.9		7.6		7.2		7.2	
2130P-A079 ²	3.9	8.9	3.4	9.0	3.3	9.1	3.2	9.5	3.1	9.8	3.0	10.1	2.9	10.6
	14.8		12.9		12.5		12.1		11.7		11.4		11.0	

* indicates intermittent duty only ¹ Tested at 13.5 VDC ² Tested at 110 VAC

VERSA-TWIN 2130 SERIES PLUNGER PUMPS WITH PRESSURE SWITCH

THE INDUSTRY-FIRST INTEGRATED AUTOMATIC-DEMAND PRESSURE SWITCH

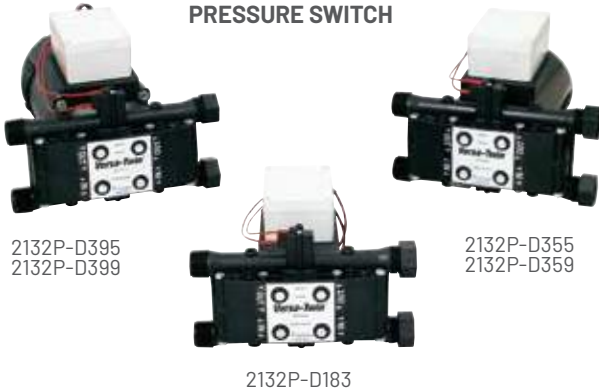

FEATURES

- ◆ Integrated pressure switch designed for the pump to work as a demand pump
- ◆ Extends the life of the pump when the duty cycle is less than 100%, for example, a 50% duty cycle extends the life of the system two times and a 25% duty cycle extends the life four times
- ◆ Reduces end-user installation charges by allowing a system to be set up for overnight charging versus continuous charging through a custom, high-amp vehicle alternator and heavy-gage wiring system

ORDER INFORMATION

Model Number	Max GPM	Max L/min	Max PSI	Max BAR	Max RPM	Motor Type	Pressure Switch	Ports
2132P-D183	2.5	9.5	150	10.3	2200	1/4 HP 12V DC Motor, 20 amps	150-250 PSI (10.3-17.2 BAR)	1" MNPT
2132P-D355	2.8	10.6	250	17.2	2000	1/2 HP 12V DC Motor, 35 amps	150-250 PSI (10.3-17.2 BAR)	
2132P-D359	3.9	14.8	200	13.8	2000	1/2 HP 12V DC Motor, 35 amps	150-250 PSI (10.3-17.2 BAR)	
2132P-D395	2.9	11.0	250	17.2	2000	1/2 HP 12V DC Motor, 39 amps	150-250 PSI (10.3-17.2 BAR)	
2132P-D399	4.0	15.1	200	13.8	2000	1/2 HP 12V DC Motor, 39 amps	150-250 PSI (10.3-17.2 BAR)	
2133P-D355	2.8	10.6	300	20.7	2000	1/2 HP 12V DC Motor, 35 amps	250-350 PSI (17.2-24.1 BAR)	
2133P-D395	2.9	11.0	300	20.7	2000	1/2 HP 12V DC Motor, 56C, 39 amps	250-350 PSI (17.2-24.1 BAR)	
2132PX	Replacement pump head & switch						150-250 PSI (10.3-17.2 BAR)	
2133PX	Replacement pump head & switch						250-350 PSI (17.2-24.1 BAR)	

PERFORMANCE

Model Number	0 PSI / 0 BAR		50 PSI / 3.5 BAR		100 PSI / 6.9 BAR		150 PSI / 10.3 BAR		200 PSI / 13.8 BAR		250 PSI / 17.2 BAR		300 PSI / 20.7 BAR	
	GPM	AMPS	GPM	AMPS	GPM	AMPS	GPM	AMPS	GPM	AMPS	GPM	AMPS	GPM	AMPS
	L / min		L / min		L / min		L / min		L / min		L / min		L / min	
2132P-D183 ¹	2.5	5.2	2.2	9.8	2.0	14.6*	1.8	19.3*	-	-	-	-	-	-
	9.5		8.3		7.6		6.8		-		-			
2132P-D355 ¹	2.8	9.1	2.5	13.4	2.4	18.9	2.3	23.5	2.2	27.5*	2.1	30.9*	2.0	34.8*
2133P-D355 ¹	10.6		9.5		9.1		8.7		8.3		7.9		7.6	
2132P-D359 ¹	3.9	11.6	3.2	17.2	3.1	21.5	3.0	26.2*	2.8	31.8*	-	-	-	-
	14.8		12.1		11.7		11.4		10.6		-			
2132P-D395 ¹	2.9	8.3	2.5	13.0	2.4	19.0	2.3	23.5	2.2	27.2	2.1	30.7	2.0	33.9
2133P-D395 ¹	11.0		9.5		9.1		8.7		8.3		7.9		7.6	
2132P-D399 ¹	4.0	11.0	3.5	17.2	3.3	24.0	3.1	29.3	3.0	34.2	-	-	-	-
	15.1		13.2		12.5		11.7		11.4		-			

* indicates intermittent duty only ¹ Tested at 13.5 VDC ² Tested at 110 VAC

VERSA-TWIN 2150 SERIES DIAPHRAGM PUMPS



ORDER INFORMATION

Model Number	Max GPM	Max LPM	Max PSI	Max BAR	Max RPM	Motor Type	Ports
2150P-D35DC	7	26.5	100	6.9	1800	1/2 HP 12V DC Motor, 35 amps	3/4" MNPT
2150P-D39DC	8.3	31.4	100	6.9	1800	1/2 HP 12V DC Motor, 56C, 39 amps	
2150P-D05AC	6.7	25.4	100	6.9	1750	1/2 HP 115-208/230 VAC Motor, 1PH, 50/60 Hz	
2150PX						Replacement pump head	
3430-0633						Diaphragm repair kit	
3430-0634						Diaphragm valve kit	

Model	GPM	AMPS	GPM	AMPS	GPM	AMPS	GPM	AMPS	GPM	AMPS	GPM	AMPS
	LPM	AMPS	LPM	AMPS	LPM	AMPS	LPM	AMPS	LPM	AMPS	LPM	AMPS
	0 PSI/0 BAR		20 PSI/1.4 BAR		40 PSI/2.8 BAR		60 PSI/4.1 BAR		80 PSI/5.5 BAR		100 PSI/6.9 BAR	
2150P-D35DC ¹	7.0	12.9	6.6	17.2	6.0	22.3	5.6	26.8*	5.2	31.2*	5.0	35.3*
	26.5		25.0		22.7		21.2		19.7		18.9	
2150P-D39DC ¹	8.3	15.7	7.6	19.7	6.7	23.8	6.1	27.8	5.7	31.9	5.3	35.9
	31.4		28.8		25.4		23.1		21.6		20.1	
2150P-D05AC ²	6.7	7.6	6.4	7.7	6.0	7.8	5.7	7.9	5.3	8.0	5.0	8.2
	25.4		24.2		22.7		21.6		20.1		18.9	

* Indicates intermittent duty only ¹ Tested at 13.5 VDC ² Tested at 110 VAC

VERSA-TWIN ACCESSORIES



HOSEBARB FLY NUT FITTINGS

O-ring Groove x Hose Barb	Fitting Part Number	Fly nut Part Number	O-ring Part Number
1" x 1" straight	FNS-100100	3B100	1721-0010
1" x 3/4" straight	FNS-10034		
1" x 1/2" straight	FNS-10012		
1" x 1" elbow	FNE-100100		
1" x 3/4" elbow	FNE-10034		



NPT FLY NUT FITTINGS

Fly Nut connection X NPT			
O-ring Groove x NPT	Fitting Part Number	Fly nut Part Number	O-ring Part Number
1" x 3/4" MNPT *	2404-0427	3B100	1721-0010
1" x 1/2" MNPT	2404-0419		

* Compatible with other fly-nut fittings in catalog

FLY NUT CAP

Description	Part Number
1" NPT with gasket	FNCAP-100N
Replacement gasket	01WSHR13



UNLOADER VALVE

Part Number	Operating PSI	Operating BAR	Use With	Material
3390-0062D	200-600	13.8-41.4	35 & 39 amp DC, and all AC motors	Brass, Buna-N Cup



PULSE HOSE

Part Number	Max PSI	Max BAR	Description
3375-0025*	1500	183.4	9 ft Pulse Hose, 3/8" (M)NPT w/ one plugged end

*Used with all pressure switch models when using rigid pipe, rigid or semi-rigid hose (working pressure greater than 600 psi) or any hose less than 150 ft.

RELIEF VALVE

Part Number	Operating PSI	Operating BAR	Material	Ports (Inlet x Outlet)	Use With
3300-0001	400	27.6	Bronze	3/4" MNPT x 3/4" FNPT	35 & 39 amp DC, and all AC motors
3300-0002	200	13.8	Bronze	1/2" MNPT x 1/2" FNPT	18 amp DC motors
3300-0015	150	10.3	Nylon	3/4" MNPT x 3/4" FNPT	18 amp DC motors
3300-0016	250	17.2	Nylon	3/4" MNPT x 3/4" FNPT	35 & 39 amp DC, and all AC motors
3300-0098	400	27.6	Nylon	3/4" MNPT x 3/4" FNPT	18 amp DC motors
3301-0001	400	27.6	Bronze	3/4" MNPT x 3/4" FNPT	35 & 39 amp DC, and all AC motors



ELECTRIC-DRIVEN CENTRIFUGAL PUMPS – NORYL

Model 9940-9750NRL, 9940-9751NRL, 9940-9753NRL



MODEL 9940-9750NRL

- ◆ Noryl, pedestal mount, direct drive
- ◆ Port sizes: 1-1/2" NPT inlet
1-1/2" NPT outlet
- ◆ Max. fluid temperature: 140°F/60°C
- ◆ Housing: Noryl (chemical-resistant, coated, cast iron bearing housing)
- ◆ Impeller: Noryl
- ◆ Pump shaft rotation: CW*
- ◆ Shaft seals: Viton®/ceramic with polypropylene case
- ◆ Weight: 12 lbs./5.4 kg

MODEL 9940-9751NRL

- ◆ Noryl, close-coupled, AC motor-driven (60 Hz), centrifugal pump
- ◆ Port sizes: 1-1/2" NPT inlet
1-1/2" NPT outlet
- ◆ Max. fluid temperature: 140°F/60°C
- ◆ Housing: Noryl
- ◆ Impeller: Noryl
- ◆ Motor: 3/4 hp, 115 / 208-230V AC
- ◆ Shaft seals: Viton®/ceramic with polypropylene case
- ◆ Weight: 34 lbs./15.4 kg

MODEL 9940-9753NRL

- ◆ Noryl, close-coupled, AC motor-driven (60 Hz), centrifugal pump
- ◆ Port sizes: 1-1/2" NPT inlet,
1-1/2" NPT outlet
- ◆ Max. fluid temperature: 140°F/60°C
- ◆ Housing: Noryl
- ◆ Impeller: Noryl
- ◆ Motor: 1-1/2 hp, 115 / 208-230V AC
- ◆ Shaft seals: Viton®/ceramic with polypropylene case
- ◆ Weight: 39 lbs./17.7 kg

ORDER INFORMATION

Model Number	Max GPM	Max LPM	Max PSI	Max BAR	Max RPM
9940-9750NRL	140	530	39	2.7	3600
9940-9751NRL	47	178	30	2.1	3450
9940-9753NRL	91	344	35	2.4	3450

9940-9750NRL

U.S. UNITS

RPM	10 PSI		15 PSI		20 PSI		25 PSI		30 PSI		35 PSI	
	GPM	HP	GPM	HP	GPM	HP	GPM	HP	GPM	HP	GPM	HP
3000	103	1.5	90	1.4	72	1.4	38	1.0				
3450	126	2.4	114	2.4	101	2.2	86	2.2	64	1.9	14	1.4
3600	132	2.7	121	2.6	110	2.5	97	2.5	80	2.3	52	2.0

9940-9750NRL

METRIC UNITS

RPM	0.7 BAR		1.0 BAR		1.4 BAR		1.7 BAR		2.1 BAR		2.4 BAR	
	LPM	HP	LPM	HP	LPM	HP	LPM	HP	LPM	HP	LPM	HP
3000	390	1.5	341	1.4	273	1.4	144	1.0				
3450	477	2.4	432	2.4	382	2.2	326	2.2	242	1.9	53	1.4
3600	500	2.7	458	2.6	416	2.5	367	2.5	303	2.3	197	2.0

9940-9751NRL, 9940-9753NRL

U.S. UNITS

MODEL	5 PSI		10 PSI		15 PSI		20 PSI		25 PSI		30 PSI	
	GPM	AMPS	GPM	AMPS	GPM	AMPS	GPM	AMPS	GPM	AMPS	GPM	AMPS
9751	44	7.9	39	8.0	32	8.3	25	8.5	15	8.5	2	8.4
9753	88	14.1	82	14.0	74	14.0	66	14.4	55	14.4	37	13.6

9940-9751NRL, 9940-9753NRL

METRIC UNITS

MODEL	0.3 BAR		0.7 BAR		1.0 BAR		1.4 BAR		1.7 BAR		2.1 BAR	
	LPM	AMPS	LPM	AMPS	LPM	AMPS	LPM	AMPS	LPM	AMPS	LPM	AMPS
9751	167	7.9	148	8.0	121	8.3	95	8.5	57	8.5	8	8.4
9753	333	14.1	310	14.0	280	14.0	250	14.4	208	14.4	140	13.6

Noryl® is a registered trademark of of Sabic Innovative Plastics Holding BV. Hypro® is a registered trademark of Pentair.

HYDRAULIC-DRIVEN GEAR PUMP

Model 8304B-HM5C



This positive-displacement pump is ideal for de-icing/anti-icing (pre-wet). Combining the pump and motor as a single unit eliminates the need for shaft alignment or Love-Joy® coupling. The unit's compact size allows it to be used in a wide variety of locations and makes it especially attractive for quick, easy retrofit installations.

PUMP

- ◆ Optional pressure relief valve safeguards against pressure buildup (8304BV models)
- ◆ Industry-proven gear pump design, minimal moving parts for longevity
- ◆ Brass material not corroded by salt solutions

MOTOR

- ◆ State-of-the-art internal gear gerotor motor for superior service life
- ◆ Bypass adjustment allows fine tuning of flow control
- ◆ Hydraulic ports: 1/2" NPT inlet, 3/4" NPT outlet with check valve to safeguard against change in flow direction

ORDER INFORMATION

Model Number	Max GPM	Max LPM	Max PSI	Max BAR	Max Hyd GPM	Max Hyd LPM
8304B-HM5C	10.4	39.4	100	6.9	4.5	17
8304BV-HM5C	10.4	39.4	100	6.9	4.5	17
8304B	10.4	39.4	100	6.9	4.5	17
8304BV	10.4	39.4	100	6.9	4.5	17

PERFORMANCE

Hydraulic Flow (GPM)	GPM at 0 PSI	GPM at 10 PSI	GPM at 20 PSI	GPM at 30 PSI	GPM at 40 PSI	GPM at 50 PSI	GPM at 60 PSI	GPM at 70 PSI	GPM at 80 PSI	GPM at 90 PSI	GPM at 100 PSI
3.0	6.9	6.5	6.1	5.7	5.3	4.9	4.5	4.1	3.7	3.3	2.9
3.5	8.1	7.7	7.3	6.9	6.6	6.2	5.8	5.4	5.0	4.6	4.2
4.0	9.2	8.9	8.5	8.1	7.8	7.4	7.0	6.7	6.2	5.9	5.5
4.5	10.4	10.1	9.7	9.3	9.0	8.6	8.2	7.9	7.5	7.1	6.8

This data was generated using water as the pumping media. Performance will vary with different viscosity fluids.

Hydraulic pressures vary from 200 to 850 PSI for the performance chart above.

* Product is to be run above 2.0 GPM hydraulic flow.

AQUA-TIGER - 12-VOLT CENTRIFUGAL PUMP

Model 9700B and 9700S



- ◆ 12-volt DC motor drive
- ◆ Port sizes: 3/4" NPT inlet, 3/4" NPT outlet
- ◆ Max. fluid temperature: 140°F/60°C
- ◆ Housing: bronze or stainless steel
- ◆ Impeller: bronze (9700B) or stainless steel (9700S)
- ◆ Seal: lip-type Viton (9700B); mechanical (9700S)
- ◆ Weight: 6 lbs./2.7 kg

ORDER INFORMATION

Model Number	Max GPM	Max LPM	Max PSI	Max BAR	Max Draw
9700B	19	72	7	0.48	11 Amps
9700S	19	72	7	0.48	11 Amps

9700B, 9700S - 13.5 VDC (ALTERNATOR ENGINE RUNNING)

U.S. UNITS

2 PSI		3 PSI		4 PSI		5 PSI		6 PSI		7 PSI	
GPM	AMPS	GPM	AMPS	GPM	AMPS	GPM	AMPS	GPM	AMPS	GPM	AMPS
16.9	5.3	14.0	5.0	12.5	4.9	10	4.9	6.5	4.1	2.7	3.7

9700B, 9700S - 13.5 VDC (ALTERNATOR ENGINE RUNNING)

METRIC UNITS

0.14 BAR		0.21 BAR		0.28 BAR		0.34 BAR		0.41 BAR		0.48 BAR	
LPM	AMPS	LPM	AMPS	LPM	AMPS	LPM	AMPS	LPM	AMPS	LPM	AMPS
62	5.3	53	5.0	47	4.9	38	4.9	25	4.1	10	3.7

POWERPRO GASOLINE ENGINES

High Quality, Field-Proven Engine



- ◆ Available in multiple horsepower options to suit a diverse range of agricultural, industrial, and lawn & garden applications
- ◆ Electric-start option available for quick start-up
- ◆ Dual-element air filter provides highest degree of filtering
- ◆ Cast iron cylinder sleeve for commercial use
- ◆ Overhead valve for cleaner operation on all models
- ◆ Equipped with a robust low-oil sensor to prevent engine damage
- ◆ CARB/EPA certified engines
- ◆ Engines can be configured to various Hypro pump models or purchased individually
- ◆ Supported with a one-year warranty from Hypro; repair parts available for easy servicing

13 HP Electric Start

POWERPRO GASOLINE ENGINES, RECOIL START

CARB & EPA Part Number	EC Part Number	HP	Shaft Size
2549-0043	—	2.5	5/8" Keyed
2541-0045	2541-0065	6.5	3/4" Keyed
2541-0046	—	6.5	5/8" Threaded
2541-0048	—	13	1" Keyed

POWERPRO GASOLINE ENGINES, ELECTRIC START

CARB & EPA Part Number	HP	Shaft Size
2541-0053	6.5	3/4" Keyed
2541-0054*	6.5	2:1 reduced 3/4" Shaft
2541-0055	6.5	5/8" Threaded
2541-0049	13	1" Keyed
2541-0051	13	1" Threaded

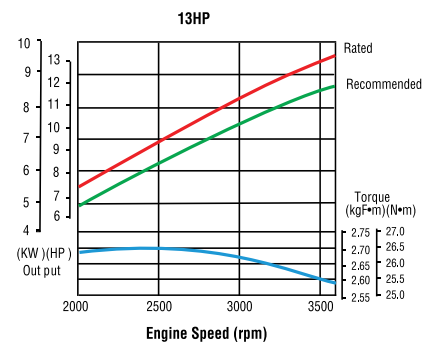
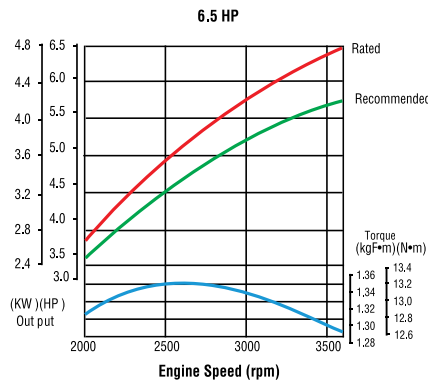
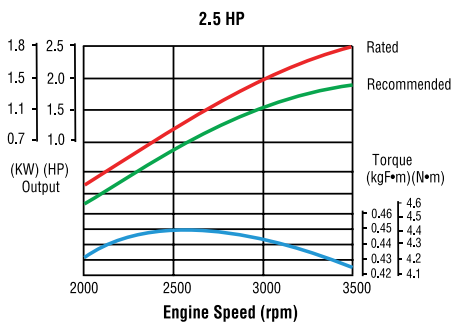

SPRAY NOZZLES

BROADCAST SPRAY NOZZLES PAGE 140

Commonly used for herbicide, insecticide, and fungicides

- ◆ Most effective with a tapered fan, designed for spray overlap, ensuring uniformity

BROADCAST WIDE-ANGLE SPRAY NOZZLES PAGE 162

Commonly used with fertilizers and specialty applications

- ◆ Wide spray pattern can overlap with adjacent patterns and improve uniformity

STREAMING SPRAY NOZZLES PAGE 166

Commonly used for fertilizer applications

- ◆ Single streams are good for heavy crop residues and tilled fields.
- ◆ Multiple streams are good for crops like wheat, where minimal plant burn is required

BANDING & DIRECTED SPRAY NOZZLES PAGE 170

Used for various applications including agricultural spraying and orchard/vineyard spraying

- ◆ Even spray nozzles are designed to eliminate spray pattern overlap; used for spraying between crop rows or specific targeted areas

SPECIALTY SPRAY NOZZLES PAGE 186

Includes boomless nozzles, car wash/pressure cleaning nozzles, specialty crops, acid-resistant nozzles for harsh defoliant, misting nozzles, and more

SELECTING THE RIGHT SPRAY NOZZLE



VISIT SPRAYIT.HYPROPUMPS.COM FOR HYPRO'S ONLINE NOZZLE CALCULATOR
OR DOWNLOAD THE FREE SPRAY IT APP FOR APPLE OR ANDROID DEVICES.



or



or



SELECTING THE RIGHT SPRAY NOZZLE

5) SPRAY PATTERN TYPE:

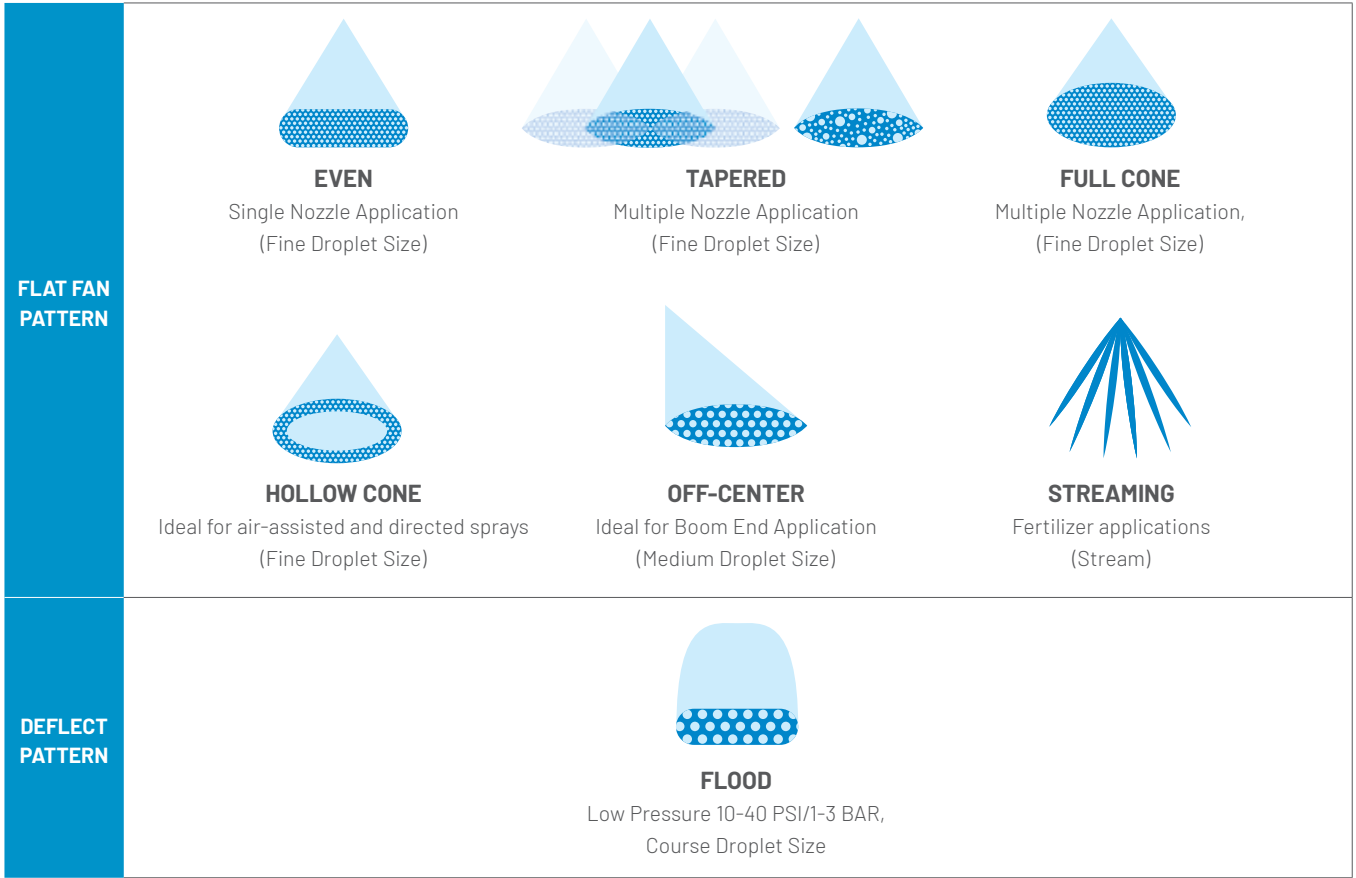

NOZZLE TECHNOLOGY:

STANDARD HYDRAULIC
(Flat Fan - VP)

PRE-ORIFICE
(Guardian-GRD)

AIR INDUCTION
(GuardianAIR Twin-GAT)

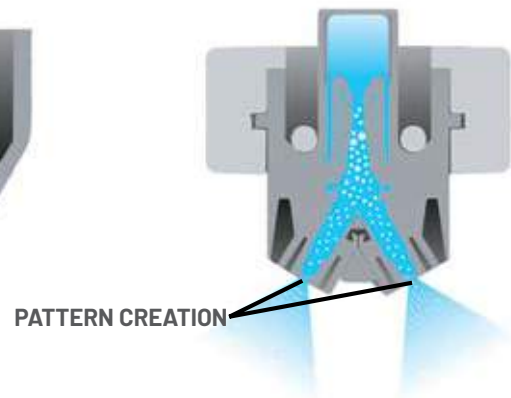
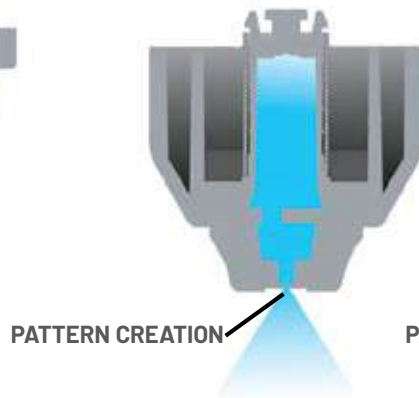
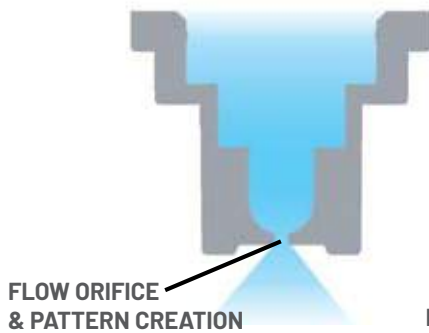

EXIT ORIFICE FUNCTION:

- ◆ Pro - Low Cost
- ◆ Con - Increased drift potential

- ◆ Pro - Reduced drift potential
- ◆ Con - Multiple pieces to clean

- ◆ Pro - Increased coverage and Reduced Drift
- ◆ Con - Reduced performance with thick suspension based solutions

6) NOZZLE SIZE AND PRESSURE:

Use the flow rate tables provided throughout this guide to select the nozzle and pressure that provides the flow needed for the application.



SELECTING THE RIGHT SPRAY NOZZLE

7) SPRAY QUALITY:

The size and the variation of droplets determine the spray quality that a nozzle produces. To apply a spray solution safely and with the most agronomic value, it must be delivered with the appropriate droplet size spectrum.

ASABE S572.1 DROPLET SIZE CLASSIFICATION

The American Society of Agricultural and Biological Engineers (ASABE) developed the ASABE S572.1 standard to measure and interpret spray quality from nozzles.

Spray Quality*	Size of Droplets	VMD Range (Microns**)	Color Code	Retention on Difficult to Wet Leaves	Drift Potential
Extremely Fine	Small	<60	Purple	Excellent	High
Very Fine		61-105	Red	Excellent	
Fine		106-235	Orange	Very Good	
Medium		236-340	Yellow	Good	
Coarse		341-403	Blue	Moderate	
Very Coarse		404-502	Green	Poor	
Extremely Coarse		503-665	White	Very Poor	
Ultra Coarse	Large	>665	Black	Very Poor	Low

*Always read the pesticide label to determine which spray quality is required.
 ** Estimated from sample reference graph in ASABE/ANSI/ASAE Standard S572.1.

The ASABE S572.1 standard uses eight droplet classification categories, six of which are common for agriculture and horticulture: Very Fine, Fine, Medium, Coarse, Very Coarse and Extremely Coarse. Most agrochemical applications recommend a fine, medium, or coarse spray.

<div style="background-color: #f4a460; padding: 2px; display: inline-block; margin-bottom: 5px;">Fine</div> <p>sprays provide enhanced retention for directed spraying on the target including:</p> <ul style="list-style-type: none"> ◆ Foliar-acting weed control ◆ Contact-acting fungicides and insecticides 	<div style="background-color: #ffff00; padding: 2px; display: inline-block; margin-bottom: 5px;">Medium</div> <p>sprays are the most widely used spray type.</p> <ul style="list-style-type: none"> ◆ Used by default by most applicators when spray quality is not defined by the label. ◆ Systemic-acting fungicides, insecticides and herbicides. 	<div style="background-color: #0070c0; padding: 2px; display: inline-block; margin-bottom: 5px;">Coarse</div> <p>sprays are used with systemic, residual, and soil-applied herbicides.</p>
---	---	---

BCPC NOZZLE CLASSIFICATION

The British Crop Protection Council (BCPC) develop a standard for classifying nozzle droplet size. The standard is based on relative comparisons of droplet size using a set of agreed upon reference nozzles.

For conventional hydraulic nozzles, spray quality varies according to nozzle size (defined by nozzle flow in l/min) and with pressure, larger sizes and lower pressures produce larger droplets. Spray quality is defined by Volume Median Diameter (VMD) which is the mid-droplet size where half of the volume of spray is in larger and half in smaller droplets. The BCPC International Spray Classification System, groups nozzles into five categories: VERY FINE, FINE, MEDIUM, COARSE AND VERY COARSE, each category covering a range of VMDs.

Air Induction (AI) nozzles incorporate air as well as fluid in the droplets. As a result they are not classified by BCPC in the same way as standard hydraulic nozzles. AI nozzles tend to have a more uniform droplets size and less of the driftable fines. Those at the finer end of the spectrum can be successfully used in place of conventional 'medium' spray quality whilst at the same time reducing spray drift.

SELECTING THE RIGHT SPRAY NOZZLE

The following chart has been designed to simplify selection of the correct spray nozzle type for the agrochemical to be applied. It is based on having good conditions for spraying and should be used in conjunction with the agrochemical manufacturer's label. Increased carrier rates may allow for coarser sprays to reduce risk of drift. Always follow the agrochemical label exactly.

Section	Code	Spray Nozzle	Common Use	Pattern	Technology	Orifice Material	Nominal Spray Angle	Pressure Range		ASABE Droplet Classification											
								PSI	BAR	XF	VF	F	M	C	VC	XC	UC				
Broadcast	ULD	Ultra Lo-Drift	Weeds	Tapered Flat Fan	Air Induction	Polyacetal	120°	20-115	1-8												
	3D	3D Nozzle	General	Tapered Flat Fan	Elliptical Orifice	Polyacetal	100°	10-90	0.7-6												
	GAT	GuardianAIR Twin	Plant Health	Tapered Flat Fan	Air Induction	Polyacetal	110°	30-115	2-8												
	ATW	Air Injected Twin Fan	Plant Health	Tapered Flat Fan	Air Induction	Ceramic	110°	40-100	3-7												
	GA	GuardianAIR	Plant Health	Tapered Flat Fan	Air Induction	Polyacetal	110°	20-115	1-8												
	AVI	Air Injected Anti-Drift	Weeds	Tapered Flat Fan	Air Induction	Ceramic	80°, 110°	30-100	2-7												
	GRD	Guardian	Plant Health	Tapered Flat Fan	Pre-Orifice	Polyacetal	120°	20-115	1-8												
	LD	Lo-Drift	Plant Health	Tapered Flat Fan	Pre-Orifice	Polyacetal	80°, 110°	20-70	1-5												
	ADI	Drift Reduction	Plant Health	Tapered Flat Fan	Air Induction	Ceramic	110°	30-70	2-5												
	VP	Variable Pressure	General	Tapered Flat Fan	Elliptical Orifice	Polyacetal	80°, 110°	20-70	1-5												
Wide	AXI	Wide Range Fan	General	Tapered Flat Fan	Elliptical Orifice	Ceramic	80°, 110°	20-70	1-5												
	F	FanTip	General	Tapered Flat Fan	Elliptical Orifice	Polyacetal	80°, 110°	30-60	2-4												
	HF	Hi-Flow	Fertilizer	Tapered Flat Fan	Pre-Orifice	Polyacetal	140°	20-80	1.5-6												
	DT	DeflectTip	Weeds & Fertilizer	Flood	Deflection	Polyacetal	80°-160°	10-60	1-4												
	Stream	ESI	Six Stream	Fertilizer	Streams	Pre-Orifice	Ceramic or Polyacetal	110° Equivalent	15-60	1-4										S	
		DC	Flow Regulating Disc	Fertilizer	Stream	Round Orifice	Polyacetal	0°	10-150	1-10										S	
		AMT	Flow Regulating Disc	Fertilizer	Stream	Round Orifice	Ceramic	0°	10-725	1-50										S	
	Bandling & Directed	DC/CR	SwirlTip Disc/Core	Plant Health	Hollow Cone	Swirl	Polyacetal	25°-110°	10-150	1-10											
		DCC/CRC	Disc and Core	Plant Health	Hollow Cone	Swirl	Ceramic	13°-93°	10-300	1-20											
		HXC	HollowTip Hollow Cone	Plant Health	Hollow Cone	Swirl	Polyacetal	80°	40-150	3-10											
ATR		Hollow Cone	Plant Health	Hollow Cone	Swirl	Ceramic	80°	40-350	3-24												
TVI		Hollow Cone	Plant Health	Hollow Cone	Air Induction	Ceramic	80°	70-360	5-25												
AVI		Air Injected Anti-Drift	Plant Health	Tapered Flat Fan	Air Induction	Ceramic	80°	40-350	3-24												
AXI		Wide Range Fan	Plant Health	Tapered Flat Fan	Elliptical Orifice	Ceramic	80°	40-350	3-24												
DCC/CRC		Disc and Core	Plant Health	Full Cone	Swirl	Ceramic	14°-71°	10-300	1-20												
FCX		Full Cone	Plant Health	Full Cone	Swirl	Polyacetal	80°	15-150	1-10												
E		FanTip Even Flat	Weeds	Even Flat Fan	Elliptical Orifice	Polyacetal	80°	30-60	2-4												
Special	OC	Off-Center Flat	Unspecialized	Off-Center Fan	Elliptical Orifice	Brass	80°	30-60	2-4												
	OCI	Off-Center Ceramic	Unspecialized	Off-Center Fan	Elliptical Orifice	Ceramic	80°	30-60	2-4												
	AVI-OC	Air Injected Off-Center	Weeds	Off-Center Fan	Air Induction	Ceramic	80°	40-100	3-7												
	XT	Boom X Tender	Weeds	Boomless Fan	Pre-Orifice	Stainless or Polyacetal	105°	30-60	2-5												
	TUR	Sudden Impact	Car Wash	0° Rotation	Turbo	Stainless or Brass	24° or 30°	800-3000	55-207												
	HP	High Pressure	Car Wash	Flat Fan	High Pressure	Hardened Stainless Steel	0°, 5°, 15°, 25°, 40°	300-4000	21-276												
	FP	FulcoJet	Car Wash	Full Cone	Swirl	PVDF	45°-80°	10-150	.7-10												
	CM	FanJet	Car Wash	Flat Fan	Elliptical Orifice	PVDF	0°-110°	30-500	2-35												
	MISTING	F, HAF, PF, AFD, AF	Cooling & Humidification	Fan or Hollow Cone	Elliptical Orifice or Swirl	Polyacetal	65°-110°	40-150	3-10												
	E	Even	Knapsack	Even Flat Fan	Elliptical Orifice	Polyacetal	80°	15-45	1-3												
DT/AN	Deflect Nozzle/PoliJet	Knapsack	Flood	Deflection	Polyacetal	53.-127°	15-45	1-3													

S These nozzles produce streams to minimize atomization

UNDERSTANDING DROPLET VMD

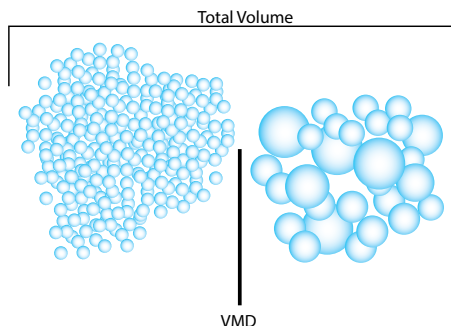

VMD is the droplet size at which 50% of the spray volume is in droplets larger than the VMD and 50% of the volume is in droplets smaller than the VMD (adapted from Matthews 1992).

UNDERSTANDING MICRON SIZE

Degree of Atomization	Droplet Size (Microns)	Relative Size Related to Common Objects
Fog	Up to 25	Point of a Needle (25 Microns)
Fine Mist	20-100	Human Hair (100 Microns)
Fine Drizzle	100-250	Sewing Thread (150 Microns)
Heavy Drizzle	250-500	Toothbrush Bristle (300 Microns)
Light Rain	500-800	Staple (550 Microns)
Heavy Rain	800-1000	Paper Clip (850 Microns)
Thunderstorm Rain	1000-4000	#2 Pencil Lead (2000 Microns)

- ◆ Droplet sizes are usually expressed in microns (micrometers).
- ◆ One micron equals one thousandth of a millimeter.
- ◆ Lower spraying pressures provide larger droplet sizes, while higher spraying pressures yield smaller droplet sizes.
- ◆ The smallest droplet sizes are achieved by air atomizing nozzles.
- ◆ Generally speaking, the largest spray droplets are produced by wide-angle, flat hydraulic spray nozzles.

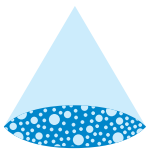

ULTRA LO-DRIFT 120°



The ULD – Ultra Lo-Drift is the ideal spray nozzle for use where drift reduction is paramount. The nozzle produces large air-filled droplets, which cut drift dramatically compared with a standard fan and conventional low-drift spray nozzles.

- ◆ Creates air-filled droplets which significantly reduce spray drift
- ◆ Wide spray angle (120°) enables boom height to be lowered to further decrease drift
- ◆ Small, compact size reduces the chances of accidental breakage
- ◆ FastCap complete includes nozzle, cap, gasket and integrated strainers

US UNITS

Nozzle Size	Droplet Size	Pressure (PSI)	Flow Rate (GPM)	Speed (MPH) - 20 inch nozzle spacing																
				Gallons per Acre																
				2.5	5	7.5	10	12.5	15	17.5	20	22.5	25	27.5	30	32.5	35	37.5	40	
015	UC	20	0.11	12.6	6.3	4.2	3.2	2.5	2.1	1.8	1.6	1.4	1.3	1.1	1.1	0.9	0.8	0.8		
	XC	30	0.13	15.4	7.7	5.1	3.9	3.1	2.6	2.2	1.9	1.7	1.5	1.4	1.3	1.2	1.1	1.0		
	VC	40	0.15	17.8	8.9	5.9	4.5	3.6	3.0	2.5	2.2	2.0	1.8	1.6	1.5	1.4	1.3	1.2		
	VC	50	0.17	19.9	10.0	6.6	5.0	4.0	3.3	2.8	2.5	2.2	2.0	1.8	1.7	1.5	1.4	1.3		
	C	60	0.18	21.8	10.9	7.3	5.5	4.4	3.6	3.1	2.7	2.4	2.2	2.0	1.8	1.7	1.6	1.5		
	C	70	0.20	23.6	11.8	7.9	5.9	4.7	3.9	3.4	2.9	2.6	2.4	2.1	2.0	1.8	1.7	1.6		
	C	80	0.21	25.2	12.6	8.4	6.3	5.0	4.2	3.6	3.2	2.8	2.5	2.3	2.1	1.9	1.8	1.7		
	M	90	0.23	26.7	13.4	8.9	6.7	5.3	4.5	3.8	3.3	3.0	2.7	2.4	2.2	2.1	1.9	1.8		
	M	100	0.24	28.2	14.1	9.4	7.0	5.6	4.7	4.0	3.5	3.1	2.8	2.6	2.3	2.2	2.0	1.9		
	M	115	0.25	-	15.1	10.1	7.6	6.0	5.0	4.3	3.8	3.4	3.0	2.7	2.5	2.3	2.2	2.0		
02	UC	20	0.14	16.8	8.4	5.6	4.2	3.4	2.8	2.4	2.1	1.9	1.7	1.5	1.4	1.3	1.2	1.1		
	XC	30	0.17	20.6	10.3	6.9	5.1	4.1	3.4	2.9	2.6	2.3	2.1	1.9	1.7	1.6	1.5	1.4		
	C	40	0.20	23.8	11.9	7.9	5.9	4.8	4.0	3.4	3.0	2.6	2.4	2.2	2.0	1.8	1.7	1.6		
	C	50	0.22	26.6	13.3	8.9	6.6	5.3	4.4	3.8	3.3	3.0	2.7	2.4	2.2	2.0	1.9	1.8		
	C	60	0.24	29.1	14.5	9.7	7.3	5.8	4.8	4.2	3.6	3.2	2.9	2.6	2.4	2.2	2.1	1.9		
	M	70	0.26	-	15.7	10.5	7.9	6.3	5.2	4.5	3.9	3.5	3.1	2.9	2.6	2.4	2.2	2.1		
	M	80	0.28	-	16.8	11.2	8.4	6.7	5.6	4.8	4.2	3.7	3.4	3.1	2.8	2.6	2.4	2.2		
	M	90	0.30	-	17.8	11.9	8.9	7.1	5.9	5.1	4.5	4.0	3.6	3.2	3.0	2.7	2.5	2.4		
	M	100	0.32	-	18.8	12.5	9.4	7.5	6.3	5.4	4.7	4.2	3.8	3.4	3.1	2.9	2.7	2.5		
	M	115	0.34	-	20.1	13.4	10.1	8.1	6.7	5.8	5.0	4.5	4.0	3.7	3.4	3.1	2.9	2.7		
025	XC	20	0.18	21.0	10.5	7.0	5.3	4.2	3.5	3.0	2.6	2.3	2.1	1.9	1.8	1.6	1.5	1.4		
	XC	30	0.22	25.7	12.9	8.6	6.4	5.1	4.3	3.7	3.2	2.9	2.6	2.3	2.1	2.0	1.8	1.7		
	C	40	0.25	29.7	14.9	9.9	7.4	5.9	5.0	4.2	3.7	3.3	3.0	2.7	2.5	2.3	2.1	2.0		
	C	50	0.28	-	16.6	11.1	8.3	6.6	5.5	4.7	4.2	3.7	3.3	3.0	2.8	2.6	2.4	2.2		
	C	60	0.31	-	18.2	12.1	9.1	7.3	6.1	5.2	4.5	4.0	3.6	3.3	3.0	2.8	2.6	2.4		
	M	70	0.33	-	19.6	13.1	9.8	7.9	6.5	5.6	4.9	4.4	3.9	3.6	3.3	3.0	2.8	2.6		
	M	80	0.35	-	21.0	14.0	10.5	8.4	7.0	6.0	5.3	4.7	4.2	3.8	3.5	3.2	3.0	2.8		
	M	90	0.38	-	22.3	14.9	11.1	8.9	7.4	6.4	5.6	5.0	4.5	4.1	3.7	3.4	3.2	3.0		
	M	100	0.40	-	23.5	15.7	11.7	9.4	7.8	6.7	5.9	5.2	4.7	4.3	3.9	3.6	3.4	3.1		
	M	115	0.42	-	25.2	16.8	12.6	10.1	8.4	7.2	6.3	5.6	5.0	4.6	4.2	3.9	3.6	3.4		
03	XC	20	0.21	25.2	12.6	8.4	6.3	5.0	4.2	3.6	3.2	2.8	2.5	2.3	2.1	1.9	1.8	1.7		
	XC	30	0.26	-	15.4	10.3	7.7	6.2	5.1	4.4	3.9	3.4	3.1	2.8	2.6	2.4	2.2	2.1		
	C	40	0.30	-	17.8	11.9	8.9	7.1	5.9	5.1	4.5	4.0	3.6	3.2	3.0	2.7	2.5	2.4		
	C	50	0.34	-	19.9	13.3	10.0	8.0	6.6	5.7	5.0	4.4	4.0	3.6	3.3	3.1	2.8	2.7		
	C	60	0.37	-	21.8	14.5	10.9	8.7	7.3	6.2	5.5	4.8	4.4	4.0	3.6	3.4	3.1	2.9		
	M	70	0.40	-	23.6	15.7	11.8	9.4	7.9	6.7	5.9	5.2	4.7	4.3	3.9	3.6	3.4	3.1		
	M	80	0.42	-	25.2	16.8	12.6	10.1	8.4	7.2	6.3	5.6	5.0	4.6	4.2	3.9	3.6	3.2		
	M	90	0.45	-	26.7	17.8	13.4	10.7	8.9	7.6	6.7	5.9	5.3	4.9	4.5	4.1	3.8	3.6		
	M	100	0.47	-	28.2	18.8	14.1	11.3	9.4	8.1	7.0	6.3	5.6	5.1	4.7	4.3	4.0	3.8		
	M	115	0.51	-	-	-	20.1	15.1	12.1	10.1	8.6	7.6	6.7	6.0	5.5	5.0	4.6	4.3		
04	UC	20	0.28	-	16.8	11.2	8.4	6.7	5.6	4.8	4.2	3.7	3.4	3.1	2.8	2.6	2.4	2.2		
	UC	30	0.35	-	20.6	13.7	10.3	8.2	6.9	5.9	5.1	4.6	4.1	3.7	3.4	3.2	2.9	2.7		
	UC	40	0.40	-	23.8	15.8	11.9	9.5	7.9	6.8	5.9	5.3	4.8	4.3	4.0	3.7	3.4	3.2		
	XC	50	0.45	-	26.6	17.7	13.3	10.6	8.9	7.6	6.6	5.9	5.3	4.8	4.4	4.1	3.8	3.5		
	XC	60	0.49	-	29.1	19.4	14.5	11.6	9.7	8.3	7.3	6.5	5.8	5.3	4.8	4.5	4.2	3.9		
	XC	70	0.53	-	-	21.0	15.7	12.6	10.5	9.0	7.9	7.0	6.3	5.7	5.2	4.8	4.5	4.2		
	VC	80	0.57	-	-	22.4	16.8	13.4	11.2	9.6	8.4	7.5	6.7	6.1	5.6	5.2	4.8	4.5		
	VC	90	0.60	-	-	23.8	17.8	14.3	11.9	10.2	8.9	7.9	7.1	6.5	5.9	5.5	5.1	4.8		
	C	100	0.63	-	-	25.0	18.8	15.0	12.5	10.7	9.4	8.3	7.5	6.8	6.3	5.8	5.4	5.0		
	C	115	0.68	-	-	26.9	20.1	16.1	13.4	11.5	10.1	9.0	8.1	7.3	6.7	6.2	5.8	5.4		
05	UC	20	0.35	-	21.0	14.0	10.5	8.4	7.0	6.0	5.3	4.7	4.2	3.8	3.5	3.2	3.0	2.8		
	UC	30	0.43	-	25.7	17.1	12.9	10.3	8.6	7.3	6.4	5.7	5.1	4.7	4.3	4.0	3.7	3.4		
	XC	40	0.50	-	29.7	19.8	14.9	11.9	9.9	8.5	7.4	6.6	5.9	5.4	5.0	4.6	4.2	4.0		
	XC	50	0.56	-	-	22.1	16.6	13.3	11.1	9.5	8.3	7.4	6.6	6.0	5.5	5.1	4.7	4.4		
	XC	60	0.61	-	-	24.2	18.2	14.5	12.1	10.4	9.1	8.1	7.3	6.6	6.1	5.6	5.2	4.8		
	VC	70	0.66	-	-	26.2	19.6	15.7	13.1	11.2	9.8	8.7	7.9	7.1	6.5	6.0	5.6	5.2		
	VC	80	0.71	-	-	28.0	21.0	16.8	14.0	12.0	10.5	9.3	8.4	7.6	7.0	6.5	6.0	5.6		
	VC	90	0.75	-	-	29.7	22.3	17.8	14.9	12.7	11.1	9.9	8.9	8.1	7.4	6.9	6.4	5.9		
	C	100	0.79	-	-	-	23.5	18.8	15.7	13.4	11.7	10.4	9.4	8.5	7.8	7.2	6.7	6.3		
	C	115	0.85	-	-	-	25.2	20.1	16.8	14.4	12.6	11.2	10.1	9.2	8.4	7.7	7.2	6.7		
06	UC	20	0.42	-	25.2	16.8	12.6	10.1	8.4	7.2	6.3	5.6	5.0	4.6	4.2	3.9	3.6	3.4		
	UC	30	0.52	-	-	15.4	12.3	10.3	8.4	7.2	6.3	5.6	5.0	4.6	4.2	3.9	3.6	3.4		
	XC	40	0.60	-	-	17.8	14.3	11.9	10.2	8.9	7.9	7.1	6.5	5.9	5.5	5.1	4.8	4.5		
	XC	50	0.67	-	-	19.9	15.9	13.3	11.4	10.0	8.9	8.0	7.2	6.6	6.1	5.7	5.3	5.0		
	VC	60	0.73	-	-	21.8	17.5	14.5	12.5	10.9	9.7	8.7	7.9	7.3	6.7	6.2	5.8	5.5		
	C	70	0.79	-	-	23.6	18.9	15.7	13.5	11.8	10.5	9.4	8.6	7.9	7.3	6.7	6.3	5.9		
	C	80	0.85	-	-	25.2	20.2	16.8	14.4	12.6	11.2	10.1	9.2	8.4	7.8	7.2	6.7	6.3		
	C	90	0.90	-	-	26.7	21.4	17.8	15.3	13.4	11.9	10.7	9.7	8.9	8.2	7.6	7.1	6.7		
	C	100	0.95	-	-	28.2	22.5	18.8	16.1	14.1	12.5	11.3	10.2	9.4	8.7	8.1	7.5	7.0		
	M	115	1.02	-	-	-	24.2	20.1	17.3	15.1	13.4	12.1	11.0	10.1	9.3	8.6	8.1	7.6		
08	UC	20	0.57	-	22.4	16.8	13.4	11.2	9.6	8.4	7.5	6.7	6.1	5.6	5.2	4.8	4.5	4.2		
	XC	30	0.69	-	27.4	20.6	16.5	13.7	11.8	10.3	9.1	8.2	7.5	6.9	6.3	5.9	5.5	5.1		
	VC	40	0.80	-	-	23.8	19.0	15.8	13.6	11.9	10.6	9.5	8.6	7.9	7.3	6.8	6.3	5.9		
	VC	50	0.89	-	-	26.6	21.3	17.7	15.2	13.3	11.8	10.6	9.7	8.9	8.2	7.6	7.1	6.6		
	C	60	0.98	-	-	29.1	23.3	19.4	16.6	14.5	12.9	11.6	10.6	9.7	9.0	8.3	7.8	7.3		
	C	70	1.06	-	-	-	25.2	21.0	18.0	15.7	14.0	12.6	11.4	10.5	9.7	9.0	8.4	7.9		
	C	80	1.13	-	-	-	26.9	22.4	19.2	16.8	14.9	13.4	12.2	11.2	10.3	9.6	9.0	8.4		
	M	90	1.20	-	-	-	28.5	23.8	20.4	17.8	15.8	14.3	13.0	11.9	11.0	10.2	9.5	8.9		
M	100	1.26	-	-	-	-	25.0	21.5	18.8	16.7	15.0	13.7	12.5							

ULTRA LO-DRIFT 120°



Maximum drift control in a 120° wide spray pattern for even coverage in broadcast applications



Unique 60° thick spray pattern for a wider coverage area. 120° wide by 60° thick pattern.



See <http://pentair.com/certifications> for the latest drift reduction standard information.

METRIC UNITS

Nozzle Size	Droplet Size	Pressure (BAR)	Flow Rate (LPM)	Application Rate L/Ha - 50cm spacing							Drift Reduction Standards	
				KM/H								
				7	8	10	12	15	20	25		30
015	UC	1	0.35	60	53	42	35	28	21	17	14	JKI
	UC	1.5	0.42	72	63	50	42	34	25	20	17	
	XC	2	0.49	84	74	59	49	39	29	24	20	
	VC	3	0.60	103	90	72	60	48	36	29	24	
	C	4	0.69	118	104	83	69	55	41	33	28	
	C	5	0.77	132	116	92	77	62	46	37	31	
	M	6	0.85	146	128	102	85	68	51	41	34	
	M	7	0.92	158	138	110	92	74	55	44	37	
02	UC	1	0.46	79	69	55	46	37	28	22	18	JKI
	UC	1.5	0.57	98	86	68	57	46	34	27	23	
	XC	2	0.65	111	98	78	65	52	39	31	26	
	C	3	0.80	137	120	96	80	64	48	38	32	
	C	4	0.92	158	138	110	92	74	55	44	37	
	M	5	1.03	177	155	124	103	82	62	49	41	
	M	6	1.13	194	170	136	113	90	68	54	45	
	M	7	1.22	209	183	146	122	98	73	59	49	
025	UC	1	0.58	99	87	70	58	46	35	28	23	JKI
	XC	1.5	0.71	122	107	85	71	57	43	34	28	
	XC	2	0.82	141	123	98	82	66	49	39	33	
	C	3	1.00	171	150	120	100	80	60	48	40	
	C	4	1.15	197	173	138	115	92	69	55	46	
	M	5	1.29	221	194	155	129	103	77	62	52	
	M	6	1.41	242	212	169	141	113	85	68	56	
	M	7	1.53	262	230	184	153	122	92	73	61	
03	UC	1	0.69	118	104	83	69	55	41	33	28	50% 2.5-8.0 BAR Ref # G-1778
	XC	1.5	0.85	146	128	102	85	68	51	41	34	
	XC	2	0.98	168	147	118	98	78	59	47	39	
	C	3	1.20	206	180	144	120	96	72	58	48	
	C	4	1.39	238	209	167	139	111	83	67	56	
	M	5	1.55	266	233	186	155	124	93	74	62	
	M	6	1.70	291	255	204	170	136	102	82	68	
	M	7	1.83	314	275	220	183	146	110	88	73	
04	UC	1	0.92	158	138	110	92	74	55	44	37	90% 2.5-3.0 BAR 75% 3.1-8.0 BAR Ref # G-1779
	UC	1.5	1.13	194	170	136	113	90	68	54	45	
	UC	2	1.31	225	197	157	131	105	79	63	52	
	UC	3	1.60	274	240	192	160	128	96	77	64	
	XC	4	1.85	317	278	222	185	148	111	89	74	
	XC	5	2.07	355	311	248	207	166	124	99	83	
	VC	6	2.26	387	339	271	226	181	136	108	90	
	C	7	2.44	418	366	293	244	195	146	117	98	
05	UC	1	1.15	197	173	138	115	92	69	55	46	90% 2.5-8.0 BAR Ref # G-1780
	UC	1.5	1.41	242	212	169	141	113	85	68	56	
	UC	2	1.63	279	245	196	163	130	98	78	65	
	XC	3	2.00	343	300	240	200	160	120	96	80	
	XC	4	2.31	396	347	277	231	185	139	111	92	
	VC	5	2.58	442	387	310	258	206	155	124	103	
	VC	6	2.83	485	425	340	283	226	170	136	113	
	C	7	3.06	525	459	367	306	245	184	147	122	
06	UC	1	1.39	238	209	167	139	111	83	67	56	JKI
	UC	1.5	1.70	291	255	204	170	136	102	82	68	
	UC	2	1.96	336	294	235	196	157	118	94	78	
	XC	3	2.40	411	360	288	240	192	144	115	96	
	VC	4	2.77	475	416	332	277	222	166	133	111	
	C	5	3.10	531	465	372	310	248	186	149	124	
	C	6	3.39	581	509	407	339	271	203	163	136	
	C	7	3.67	629	551	440	367	294	220	176	147	
08	UC	1	1.85	317	278	222	185	148	111	89	74	JKI
	UC	1.5	2.26	387	339	271	226	181	136	108	90	
	XC	2	2.61	447	392	313	261	209	157	125	104	
	VC	3	3.20	549	480	384	320	256	192	154	128	
	C	4	3.70	634	555	444	370	296	222	178	148	
	C	5	4.13	708	620	496	413	330	248	198	165	
	M	6	4.53	777	680	544	453	362	272	217	181	
	M	7	4.89	838	734	587	489	391	293	235	196	
08	UC	1	1.85	317	278	222	185	148	111	89	74	JKI
	UC	1.5	2.26	387	339	271	226	181	136	108	90	
	XC	2	2.61	447	392	313	261	209	157	125	104	
	VC	3	3.20	549	480	384	320	256	192	154	128	
	C	4	3.70	634	555	444	370	296	222	178	148	
	C	5	4.13	708	620	496	413	330	248	198	165	
	M	6	4.53	777	680	544	453	362	272	217	181	
	M	7	4.89	838	734	587	489	391	293	235	196	

Droplet size based on ASABE S572.1 standard

Features	
Common Use	Weed and disease control with systemic agrochemicals.
Pattern	Tapered Flat Fan
Technology	Air Induction
Material	Polyacetal
Spray Angle	120°
Pressure Range	20-115 PSI (1-8 BAR)
Configuration	Nozzles, FastCap Complete
Optimum Boom Height	
15" (35 cm) Spacing	15" (35 cm)
20" (50 cm) Spacing	20" (50 cm)
Part Numbers (Bags of 10)	
Nozzles 120°	FastCap 120°
ULD120-015	FC-ULD120-015*
ULD120-02	FC-ULD120-02*
ULD120-025	FC-ULD120-025*
ULD120-03	FC-ULD120-03*
ULD120-04	FC-ULD120-04*
ULD120-05	FC-ULD120-05*
ULD120-06	FC-ULD120-06*
ULD120-08	FC-ULD120-08*
Replacement Strainers	
TS01-50	50 mesh strainer (Sizes 015-08)
Replacement FastCap Gasket	
10BG-2270-0150	

* FastCap version contain nozzle filters

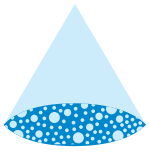

3D 100°



Designed in partnership with Syngenta using wind tunnel research and more than 10 years of agronomic field trials. Proven to deliver an increase in pre-emerge weed control compared to a conventional flat fan. Creates the optimum droplet size for coverage, fewer droplets bounce off or drift away.**

- ◆ 60-75% drift reduction compared to flat fan nozzles, achieving up to a 3 Star LERAP rating at specific nozzle size/pressure combinations
- ◆ Inclined spray is designed to be installed alternating forward and backward on boom to provide 3-dimensional coverage on vertical targets such as grass weeds, soil clods and broad leaved canopies

US UNITS

Nozzle Size	Droplet Size	Pressure (PSI)	Flow (GPM)	Speed (MPH) - 20 inch nozzle spacing											
				Gallons per Acre											
				5.0	7.5	10.0	12.5	15.0	17.5	20.0	22.5	25.0	27.5	30.0	
015	C	10*	0.08	4.5	3.0	2.2	1.8	1.5	1.3	1.1	1.0	0.9	0.8	0.7	
	M	15*	0.09	5.5	3.6	2.7	2.2	1.8	1.6	1.4	1.2	1.1	1.0	0.9	
	F	20	0.11	6.3	4.2	3.2	2.5	2.1	1.8	1.6	1.4	1.3	1.1	1.1	
	F	30	0.13	7.7	5.1	3.9	3.1	2.6	2.2	1.9	1.7	1.5	1.4	1.3	
	F	40	0.15	8.9	5.9	4.5	3.6	3.0	2.5	2.2	2.0	1.8	1.6	1.5	
	F	50	0.17	10.0	6.6	5.0	4.0	3.3	2.8	2.5	2.2	2.0	1.8	1.7	
	F	60	0.18	10.9	7.3	5.5	4.4	3.6	3.1	2.7	2.4	2.2	2.0	1.8	
	F	70	0.20	11.8	7.9	5.9	4.7	3.9	3.4	2.9	2.6	2.4	2.1	2.0	
	F	80	0.21	12.6	8.4	6.3	5.0	4.2	3.6	3.2	2.8	2.5	2.3	2.1	
	F	90	0.23	13.4	8.9	6.7	5.3	4.5	3.8	3.3	3.0	2.7	2.4	2.2	
02	M	10*	0.10	5.9	4.0	3.0	2.4	2.0	1.7	1.5	1.3	1.2	1.1	1.0	
	M	15*	0.12	7.3	4.8	3.6	2.9	2.4	2.1	1.8	1.6	1.5	1.3	1.2	
	M	20	0.14	8.4	5.6	4.2	3.4	2.8	2.4	2.1	1.9	1.7	1.5	1.4	
	M	30	0.17	10.3	6.9	5.1	4.1	3.4	2.9	2.6	2.3	2.1	1.9	1.7	
	F	40	0.20	11.9	7.9	5.9	4.8	4.0	3.4	3.0	2.6	2.4	2.2	2.0	
	F	50	0.22	13.3	8.9	6.6	5.3	4.4	3.8	3.3	3.0	2.7	2.4	2.2	
	F	60	0.24	14.9	9.9	7.4	5.9	5.0	4.2	3.6	3.2	2.9	2.6	2.4	
	F	70	0.26	15.7	10.5	7.9	6.3	5.2	4.5	3.9	3.5	3.1	2.9	2.6	
	F	80	0.28	16.8	11.2	8.4	6.7	5.6	4.8	4.2	3.7	3.4	3.1	2.8	
	F	90	0.30	17.8	11.9	8.9	7.1	5.9	5.1	4.5	4.0	3.6	3.2	3.0	
025	C	10*	0.13	7.4	5.0	3.7	3.0	2.5	2.1	1.9	1.7	1.5	1.4	1.2	
	M	15*	0.15	9.1	6.1	4.5	3.6	3.0	2.6	2.3	2.0	1.8	1.7	1.5	
	M	20	0.18	10.5	7.0	5.3	4.2	3.5	3.0	2.6	2.3	2.1	1.9	1.8	
	M	30	0.22	12.9	8.6	6.4	5.1	4.3	3.7	3.2	2.9	2.6	2.3	2.1	
	M	40	0.25	14.9	9.9	7.4	5.9	5.0	4.2	3.7	3.3	3.0	2.7	2.5	
	F	50	0.28	16.6	11.1	8.3	6.6	5.5	4.7	4.2	3.7	3.3	3.0	2.8	
	F	60	0.31	18.2	12.1	9.1	7.3	6.1	5.2	4.5	4.0	3.6	3.3	3.0	
	F	70	0.33	19.6	13.1	9.8	7.9	6.5	5.6	4.9	4.4	3.9	3.6	3.3	
	F	80	0.35	21.0	14.0	10.5	8.4	7.0	6.0	5.3	4.7	4.2	3.8	3.5	
	F	90	0.38	22.3	14.9	11.1	8.9	7.4	6.4	5.6	5.0	4.5	4.1	3.7	
03	VC	10*	0.15	8.9	5.9	4.5	3.6	3.0	2.5	2.2	2.0	1.8	1.6	1.5	
	C	15*	0.18	10.9	7.3	5.5	4.4	3.6	3.1	2.7	2.4	2.2	2.0	1.8	
	M	20	0.21	12.6	8.4	6.3	5.0	4.2	3.6	3.2	2.8	2.5	2.3	2.1	
	M	30	0.26	15.4	10.3	7.7	6.2	5.1	4.4	3.9	3.4	3.1	2.8	2.6	
	M	40	0.30	17.8	11.9	8.9	7.1	5.9	5.1	4.5	4.0	3.6	3.2	3.0	
	M	50	0.34	19.9	13.3	10.0	8.0	6.6	5.7	5.0	4.4	4.0	3.6	3.3	
	F	60	0.37	21.8	14.5	10.9	8.7	7.3	6.2	5.5	4.8	4.4	4.0	3.6	
	F	70	0.40	23.6	15.7	11.8	9.4	7.9	6.7	5.9	5.2	4.7	4.3	3.9	
	F	80	0.42	25.2	16.8	12.6	10.1	8.4	7.2	6.3	5.6	5.0	4.6	4.2	
	F	90	0.45	26.7	17.8	13.4	10.7	8.9	7.6	6.7	5.9	5.3	4.9	4.5	
35	VC	10*	0.18	10.4	6.9	5.2	4.2	3.5	3.0	2.6	2.3	2.1	1.9	1.7	
	C	15*	0.21	12.7	8.5	6.4	5.1	4.2	3.6	3.2	2.8	2.5	2.3	2.1	
	C	20	0.25	14.7	9.8	7.4	5.9	4.9	4.2	3.7	3.3	2.9	2.7	2.5	
	M	30	0.30	18.0	12.0	9.0	7.2	6.0	5.1	4.5	4.0	3.6	3.3	3.0	
	M	40	0.35	20.8	13.9	10.4	8.3	6.9	5.9	5.2	4.6	4.2	3.8	3.5	
	M	50	0.39	23.2	15.5	11.6	9.3	7.7	6.6	5.8	5.2	4.6	4.2	3.9	
	M	60	0.43	25.5	17.0	12.7	10.2	8.5	7.3	6.4	5.7	5.1	4.6	4.2	
	M	70	0.46	27.5	18.5	13.8	11.0	9.2	7.9	6.9	6.1	5.5	5.0	4.6	
	F	80	0.49	29.4	19.6	14.7	11.8	9.8	8.4	7.4	6.5	5.9	5.3	4.9	
	F	90	0.53	-	20.8	15.6	12.5	10.4	8.9	7.8	6.9	6.2	5.7	5.2	
04	XC	10*	0.20	11.9	7.9	5.9	4.8	4.0	3.4	3.0	2.6	2.4	2.2	2.0	
	VC	15*	0.24	14.5	9.7	7.3	5.8	4.8	4.2	3.6	3.2	2.9	2.6	2.4	
	C	20	0.28	16.8	11.2	8.4	6.7	5.6	4.8	4.2	3.7	3.4	3.1	2.8	
	M	30	0.35	20.6	13.7	10.3	8.2	6.9	5.9	5.1	4.6	4.1	3.7	3.4	
	M	40	0.40	23.8	15.8	11.9	9.5	7.9	6.8	5.9	5.3	4.8	4.3	4.0	
	M	50	0.45	26.6	17.7	13.3	10.6	8.9	7.6	6.6	5.9	5.3	4.8	4.4	
	M	60	0.49	29.1	19.4	14.5	11.6	9.7	8.3	7.3	6.5	5.8	5.3	4.8	
	M	70	0.53	-	21.0	15.7	12.6	10.5	9.0	7.9	7.0	6.3	5.7	5.2	
	M	80	0.57	-	22.4	16.8	13.4	11.2	9.6	8.4	7.5	6.7	6.1	5.6	
	F	90	0.60	-	23.8	17.8	14.3	11.9	10.2	8.9	7.9	7.1	6.5	5.9	
05	XC	10*	0.25	14.9	9.9	7.4	5.9	5.0	4.2	3.7	3.3	3.0	2.7	2.5	
	VC	15*	0.31	18.2	12.1	9.1	7.3	6.1	5.2	4.5	4.0	3.6	3.3	3.0	
	C	20	0.35	21.0	14.0	10.5	8.4	7.0	6.0	5.3	4.7	4.2	3.8	3.5	
	C	30	0.43	25.7	17.1	12.9	10.3	8.6	7.3	6.4	5.7	5.1	4.7	4.3	
	M	40	0.50	29.7	19.8	14.9	11.9	9.9	8.5	7.4	6.6	5.9	5.4	5.0	
	M	50	0.56	-	22.1	16.6	13.3	11.1	9.5	8.3	7.4	6.6	6.0	5.5	
	M	60	0.61	-	24.2	18.2	14.5	12.1	10.4	9.1	8.1	7.3	6.6	6.1	
	M	70	0.66	-	26.2	19.6	15.7	13.1	11.2	9.8	8.7	7.9	7.1	6.5	
	M	80	0.71	-	28.0	21.0	16.8	14.0	12.0	10.5	9.3	8.4	7.6	7.0	
	M	90	0.75	-	29.7	22.3	17.8	14.9	12.7	11.1	9.9	8.9	8.1	7.4	
06	XC	10*	0.30	17.8	11.9	8.9	7.1	5.9	5.1	4.5	4.0	3.6	3.2	3.0	
	VC	15*	0.37	21.8	14.5	10.9	8.7	7.3	6.2	5.5	4.8	4.4	4.0	3.6	
	C	20	0.42	25.2	16.8	12.6	10.1	8.4	7.2	6.3	5.6	5.0	4.6	4.2	
	C	30	0.52	-	20.6	15.4	12.3	10.3	8.8	7.7	6.9	6.2	5.6	5.1	
	C	40	0.60	-	23.8	17.8	14.3	11.9	10.2	8.9	7.9	7.1	6.5	5.9	
	M	50	0.67	-	26.6	19.9	15.9	13.3	11.4	10.0	8.9	8.0	7.2	6.6	
	M	60	0.73	-	29.1	21.8	17.5	14.5	12.5	10.9	9.7	8.7	7.9	7.3	
	M	70	0.79	-	-	23.6	18.9	15.7	13.5	11.8	10.5	9.4	8.6	7.9	
	M	80	0.85	-	-	25.2	20.2	16.8	14.4	12.6	11.2	10.1	9.2	8.4	
	M	90	0.90	-	-	26.7	21.4	17.8	15.3	13.4	11.9	10.7	9.7	8.9	
08	XC	10*	0.40	23.8	15.8	11.9	9.5	7.9	6.8	5.9	5.3	4.8	4.3	4.0	
	VC	15*	0.49	29.1	19.4	14.5	11.6	9.7	8.3	7.3	6.5	5.8	5.3	4.8	
	C	20	0.57	-	22.4	16.8	13.4	11.2	9.6	8.4	7.5	6.7	6.1	5.6	
	C	30	0.69	-	27.4	20.6	16.5	13.7	11.8	10.3	9.1	8.2	7.5	6.9	
	C	40	0.80	-	-	23.8	19.0	15.8	13.6	11.9	10.6	9.5	8.6	7.9	
	M	50	0.89	-	-	26.6	21.3	17.7	15.2	13.3	11.8	10.6	9.7	8.9	
	M	60	0.98	-	-	29.1	23.3	19.4	16.6	14.5	12.9	11.6	10.6	9.7	
	M	70	1.06	-	-	-	25.1	21.0	1						



Engineered spray incline designed to provide the best coverage on hard to hit targets



Optimum droplet spectrum for spray coverage

METRIC UNITS

Size	Spray Quality	Pressure BAR	Flow (L/Min)	Application Rate L/Ha - 50cm spacing													Drift Reduction Standards
				KM/H													
				6	8	10	12	14	16	18	20	22	24	26	28	30	LERAP
015	C	0.7*	0.29	58	43	35	29	25	22	19	17	16	14	13	12	12	
	M	1*	0.35	69	52	42	35	30	26	23	21	19	17	16	15	14	
	M	1.5	0.42	85	64	51	42	36	32	28	25	23	21	20	18	17	
	F	2	0.49	98	73	59	49	42	37	33	29	27	24	23	21	20	
	F	2.5	0.55	110	82	66	55	47	41	37	33	30	27	25	23	22	
	F	3	0.60	120	90	72	60	51	45	40	36	33	30	28	26	24	
02	F	4	0.69	139	104	83	69	59	52	46	42	38	35	32	30	28	
	F	5	0.77	155	116	93	77	66	58	52	46	42	39	36	33	31	
	F	6	0.85	170	127	102	85	73	64	57	51	46	42	39	36	34	
	M	0.7*	0.39	77	58	46	39	33	29	26	23	21	19	18	17	15	
	M	1*	0.46	92	69	55	46	40	35	31	28	25	23	21	20	18	
	M	1.5	0.57	113	85	68	57	48	42	38	34	31	28	26	24	23	
025	M	2	0.65	131	98	78	65	56	49	44	39	36	33	30	28	26	
	M	2.5	0.73	146	110	88	73	63	55	49	44	40	37	34	31	29	
	F	3	0.80	160	120	96	80	69	60	53	48	44	40	37	34	32	
	F	4	0.92	185	139	111	92	79	69	62	55	50	46	43	40	37	
	F	5	1.03	207	155	124	103	89	77	69	62	56	52	48	44	41	
	F	6	1.13	226	170	136	113	97	85	75	68	62	57	52	48	45	
03	C	0.7*	0.48	97	72	58	48	41	36	32	29	26	24	22	21	19	
	M	1*	0.58	115	87	69	58	49	43	38	35	31	29	27	25	23	
	M	1.5	0.71	141	106	85	71	61	53	47	42	39	35	33	30	28	
	M	2	0.82	163	122	98	82	70	61	54	49	45	41	38	35	33	
	M	2.5	0.91	183	137	110	91	78	68	61	55	50	46	42	39	37	
	F	3	1.00	200	150	120	100	86	75	67	60	55	50	46	43	40	
035	F	4	1.15	231	173	139	115	99	87	77	69	63	58	53	49	46	
	F	5	1.29	258	194	155	129	111	97	86	77	70	65	60	55	52	
	F	6	1.41	283	212	170	141	121	106	94	85	77	71	65	61	57	
	VC	0.7*	0.580	116	87	70	58	50	43	39	35	32	29	27	25	23	
	C	1*	0.693	139	104	83	69	59	52	46	42	38	35	32	30	28	
	M	1.5	0.849	170	127	102	85	73	64	57	51	46	42	39	36	34	
04	M	2	0.980	196	147	118	98	84	73	65	59	53	49	45	42	39	
	M	2.5	1.095	219	164	131	110	94	82	73	66	60	55	51	47	44	
	M	3	1.200	240	180	144	120	103	90	80	72	65	60	55	51	48	
	F	4	1.386	277	208	166	139	119	104	92	83	76	69	64	59	55	
	F	5	1.549	310	232	186	155	133	116	103	93	85	77	72	66	62	
	F	6	1.70	339	255	204	170	145	127	113	102	93	85	78	73	68	
045	VC	0.7*	0.676	135	101	81	68	58	51	45	41	37	34	31	29	27	
	C	1*	0.808	162	121	97	81	69	61	54	48	44	40	37	35	32	
	M	1.5	0.990	198	148	119	99	85	74	66	59	54	49	46	42	40	
	M	2	1.143	229	171	137	114	98	86	76	69	62	57	53	49	46	
	M	2.5	1.278	256	192	153	128	110	96	85	77	70	64	59	55	51	
	M	3	1.400	280	210	168	140	120	105	93	84	76	70	65	60	56	
05	M	4	1.617	323	242	194	162	139	121	108	97	88	81	75	69	65	
	M	5	1.807	361	271	217	181	155	136	120	108	99	90	83	77	72	
	F	6	1.98	396	297	238	198	170	148	132	119	108	99	91	85	79	
	XC	0.7*	0.773	155	116	93	77	66	58	52	46	42	39	36	33	31	
	VC	1*	0.924	185	139	111	92	79	69	62	55	50	46	43	40	37	
	C	1.5	1.131	226	170	136	113	97	85	75	68	62	57	52	48	45	
055	M	2	1.306	261	196	157	131	112	98	87	78	71	65	60	56	52	
	M	2.5	1.461	292	219	175	146	125	110	97	88	80	73	67	63	58	
	M	3	1.600	320	240	192	160	137	120	107	96	87	80	74	69	64	
	M	4	1.848	370	277	222	185	158	139	123	111	101	92	85	79	74	
	M	5	2.066	413	310	248	207	177	155	138	124	113	103	95	89	83	
	F	6	2.26	453	339	272	226	194	170	151	136	123	113	104	97	91	
06	XC	0.7*	0.966	193	145	116	97	83	72	64	58	53	48	45	41	39	
	VC	1*	1.155	231	173	139	115	99	87	77	69	63	58	53	49	46	
	C	1.5	1.414	283	212	170	141	121	106	94	85	77	71	65	61	57	
	C	2	1.633	327	245	196	163	140	122	109	98	89	82	75	70	65	
	M	2.5	1.826	365	274	219	183	156	137	122	110	100	91	84	78	73	
	M	3	2.000	400	300	240	200	171	150	133	120	109	100	92	86	80	
065	M	4	2.309	462	346	277	231	198	173	154	139	126	115	107	99	92	
	M	5	2.582	516	387	310	258	221	194	172	155	141	129	119	111	103	
	M	6	2.83	566	424	339	283	242	212	189	170	154	141	131	121	113	
	XC	0.7*	1.159	232	174	139	116	99	87	77	70	63	58	54	50	46	
	VC	1*	1.386	277	208	166	139	119	104	92	83	76	69	64	59	55	
	C	1.5	1.697	339	255	204	170	145	127	113	102	93	85	78	73	68	
07	C	2	1.960	392	294	235	196	168	147	131	118	107	98	90	84	78	
	C	2.5	2.191	438	329	263	219	188	164	146	13	120	110	101	94	88	
	M	3	2.400	480	360	288	240	206	180	160	144	131	120	111	103	96	
	M	4	2.771	554	416	333	277	238	208	185	166	151	139	128	119	111	
	M	5	3.098	620	465	372	310	266	232	207	186	169	155	143	133	124	
	M	6	3.39	679	509	407	339	291	255	226	204	185	170	157	145	136	
08	XC	0.7*	1.55	309	232	185	155	132	116	103	93	84	77	71	66	62	
	VC	1*	1.85	370	277	222	185	158	139	123	111	101	92	85	79	74	
	VC	1.5	2.26	453	339	272	226	194	170	151	136	123	113	104	97	91	
	C	2	2.61	523	392	314	261	224	196	174	157	143	131	121	112	105	
	C	2.5	2.92	584	438	351	292	250	219	195	175	159	146	135	125	117	
	C	3	3.20	640	480	384	320	274	240	213	192	175	160	148	137	128	
085	M	4	3.70	739	554	443	370	317	277	246	222	202	185	171	158	148	
	M	5	4.13	826	620	496	413	354	310	275	248	225	207	191	177	165	
	M	6	4.53	905	679	543	453	388	339	302	272	247	226	209	194	181	

Features	
Common Use	Weed control, plant health
Pattern	Alternating Tapered Flat Fans
Technology	Advanced Tapered Flat Fan
Material	Polycetal
Spray Angle	100°
Pressure Range	10-90 PSI (0.7-6 BAR)
Configuration	Tips, SnapLock
Optimum Boom Height	
15" (35cm) Spacing	15-25" (35-60 cm)
20" (50cm) Spacing	20-30" (50-75 cm)
Part Numbers	
Tips	FastCaps
3D100-015	FC-3D100-015
3D100-02	FC-3D100-02
3D100-025	FC-3D100-025
3D100-03	FC-3D100-03
3D100-035	FC-3D100-035
3D100-04	FC-3D100-04
3D100-05	FC-3D100-05
3D100-06	FC-3D100-06
3D100-08	FC-3D100-08
Replacement Tip Strainer	
TS01-50	50# strainer for all sizes

*For pressures lower than 1 BAR, nozzle spray angle may be reduced and will require a boom height of 75 cm to maintain spray distribution.

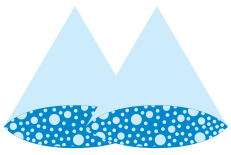

GUARDIANAIR TWIN 110°



GuardianAIR Twin spray nozzles are the best choice for high coverage applications where on-target spray delivery is important. They are ideal for low crops with complex canopies, such as vegetables, where thorough coverage of the target and protection of the surroundings are of high importance.

- ◆ High-coverage forward and rear facing fans provide coverage on both sides of target.
- ◆ Engineered to provide better coverage with more drops per gallon or litre compared to other air-induced sprays
- ◆ Easy-to-install, patent-pending locking ring and o-ring seal design
- ◆ FastCap complete includes nozzle, cap, gasket and is available with or without a filter

US UNITS

Nozzle Size	Droplet Size	Pressure (PSI)	Flow Rate (GPM)	Speed (MPH) - 20 inch nozzle spacing															
				Gallons per Acre															
				2.5	5	7.5	10	12.5	15	17.5	20	22.5	25	27.5	30	32.5	35	37.5	40
02	C	30	0.17	20.6	10.3	6.9	5.1	4.1	3.4	2.9	2.6	2.3	2.1	1.9	1.7	1.6	1.5	1.4	1.3
	M	40	0.20	23.8	11.9	7.9	5.9	4.8	4.0	3.4	3.0	2.6	2.4	2.2	2.0	1.8	1.7	1.6	1.5
	M	50	0.22	26.6	13.3	8.9	6.6	5.3	4.4	3.8	3.3	3.0	2.7	2.4	2.2	2.0	1.9	1.8	1.7
	M	60	0.24	29.1	14.5	9.7	7.3	5.8	4.8	4.2	3.6	3.2	2.9	2.6	2.4	2.2	2.1	1.9	1.8
	M	70	0.26	-	15.7	10.5	7.9	6.3	5.2	4.5	3.9	3.5	3.1	2.9	2.6	2.4	2.2	2.1	2.0
	M	80	0.28	-	16.8	11.2	8.4	6.7	5.6	4.8	4.2	3.7	3.4	3.1	2.8	2.6	2.4	2.2	2.1
M	90	0.30	-	17.8	11.9	8.9	7.1	5.9	5.1	4.5	4.0	3.6	3.2	3.0	2.7	2.5	2.4	2.2	
M	100	0.32	-	18.8	12.5	9.4	7.5	6.3	5.4	4.7	4.2	3.8	3.4	3.1	2.9	2.7	2.5	2.3	
F	115	0.34	-	20.1	13.4	10.1	8.1	6.7	5.8	5.0	4.5	4.0	3.7	3.4	3.1	2.9	2.7	2.5	
025	VC	30	0.22	25.7	12.9	8.6	6.4	5.1	4.3	3.7	3.2	2.9	2.6	2.3	2.1	2.0	1.8	1.7	1.6
	C	40	0.25	29.7	14.9	9.9	7.4	5.9	5.0	4.2	3.7	3.3	3.0	2.7	2.5	2.3	2.1	2.0	1.9
	M	50	0.28	-	16.6	11.1	8.3	6.6	5.5	4.7	4.2	3.7	3.3	3.0	2.8	2.6	2.4	2.2	2.1
	M	60	0.31	-	18.2	12.1	9.1	7.3	6.1	5.2	4.5	4.0	3.6	3.3	3.0	2.8	2.6	2.4	2.3
	M	70	0.33	-	19.6	13.1	9.8	7.9	6.5	5.6	4.9	4.4	3.9	3.6	3.3	3.0	2.8	2.6	2.5
	M	80	0.35	-	21.0	14.0	10.5	8.4	7.0	6.0	5.3	4.7	4.2	3.8	3.5	3.2	3.0	2.8	2.6
M	90	0.38	-	22.3	14.9	11.1	8.9	7.4	6.4	5.6	5.0	4.5	4.1	3.7	3.4	3.2	3.0	2.8	
M	100	0.40	-	23.5	15.7	11.7	9.4	7.8	6.7	5.9	5.2	4.7	4.3	3.9	3.6	3.4	3.1	2.9	
M	115	0.42	-	25.2	16.8	12.6	10.1	8.4	7.2	6.3	5.6	5.0	4.6	4.2	3.9	3.6	3.4	3.1	
03	VC	30	0.26	-	15.4	10.3	7.7	6.2	5.1	4.4	3.9	3.4	3.1	2.8	2.6	2.4	2.2	2.1	1.9
	C	40	0.30	-	17.8	11.9	8.9	7.1	5.9	5.1	4.5	4.0	3.6	3.2	3.0	2.7	2.5	2.4	2.2
	M	50	0.34	-	19.9	13.3	10.0	8.0	6.6	5.7	5.0	4.4	4.0	3.6	3.3	3.1	2.8	2.7	2.5
	M	60	0.37	-	21.8	14.5	10.9	8.7	7.3	6.2	5.5	4.8	4.4	4.0	3.6	3.4	3.1	2.9	2.7
	M	70	0.40	-	23.6	15.7	11.8	9.4	7.9	6.7	5.9	5.2	4.7	4.3	3.9	3.6	3.4	3.1	2.9
	M	80	0.42	-	25.2	16.8	12.6	10.1	8.4	7.2	6.3	5.6	5.0	4.6	4.2	3.9	3.6	3.4	3.2
M	90	0.45	-	26.7	17.8	13.4	10.7	8.9	7.6	6.7	5.9	5.3	4.9	4.5	4.1	3.8	3.6	3.3	
M	100	0.47	-	28.2	18.8	14.1	11.3	9.4	8.1	7.0	6.3	5.6	5.1	4.7	4.3	4.0	3.8	3.5	
M	115	0.51	-	-	20.1	15.1	12.1	10.1	8.6	7.6	6.7	6.0	5.5	5.0	4.6	4.3	4.0	3.8	
035	XC	30	0.30	-	18.0	12.0	9.0	7.2	6.0	5.1	4.5	4.0	3.6	3.3	3.0	2.8	2.6	2.4	2.3
	C	40	0.35	-	20.8	13.9	10.4	8.3	6.9	5.9	5.2	4.6	4.2	3.8	3.5	3.2	3.0	2.8	2.6
	M	50	0.39	-	23.2	15.5	11.6	9.3	7.7	6.6	5.8	5.2	4.6	4.2	3.9	3.6	3.3	3.1	2.9
	M	60	0.43	-	25.5	17.0	12.7	10.2	8.5	7.3	6.4	5.7	5.1	4.6	4.2	3.9	3.6	3.4	3.2
	M	70	0.46	-	27.5	18.3	13.8	11.0	9.2	7.9	6.9	6.1	5.5	5.0	4.6	4.2	3.9	3.7	3.4
	M	80	0.49	-	29.4	19.6	14.7	11.8	9.8	8.4	7.4	6.5	5.9	5.3	4.9	4.5	4.2	3.9	3.7
M	90	0.53	-	-	20.8	15.6	12.5	10.4	8.9	7.8	6.9	6.2	5.7	5.2	4.8	4.5	4.2	3.9	
M	100	0.55	-	-	21.9	16.4	13.1	11.0	9.4	8.2	7.3	6.6	6.0	5.5	5.1	4.7	4.4	4.1	
M	115	0.59	-	-	23.5	17.6	14.1	11.8	10.1	8.8	7.8	7.1	6.4	5.9	5.4	5.0	4.7	4.4	
04	VC	30	0.35	-	20.6	13.7	10.3	8.2	6.9	5.9	5.1	4.6	4.1	3.7	3.4	3.2	2.9	2.7	2.6
	C	40	0.40	-	23.8	15.8	11.9	9.5	7.9	6.8	5.9	5.3	4.8	4.3	4.0	3.7	3.4	3.2	3.0
	M	50	0.45	-	26.6	17.7	13.3	10.6	8.9	7.6	6.6	5.9	5.3	4.8	4.4	4.1	3.8	3.5	3.3
	M	60	0.49	-	29.1	19.4	14.5	11.6	9.7	8.3	7.3	6.5	5.8	5.3	4.8	4.5	4.2	3.9	3.6
	M	70	0.53	-	-	21.0	15.7	12.6	10.5	9.0	7.9	7.0	6.3	5.7	5.2	4.8	4.5	4.2	3.9
	M	80	0.57	-	-	22.4	16.8	13.4	11.2	9.6	8.4	7.5	6.7	6.1	5.6	5.2	4.8	4.5	4.2
M	90	0.60	-	-	23.8	17.8	14.3	11.9	10.2	8.9	7.9	7.1	6.5	5.9	5.5	5.1	4.8	4.5	
M	100	0.63	-	-	25.0	18.8	15.0	12.5	10.7	9.4	8.3	7.5	6.8	6.3	5.8	5.4	5.0	4.7	
M	115	0.68	-	-	26.9	20.1	16.1	13.4	11.5	10.1	9.0	8.1	7.3	6.7	6.2	5.8	5.4	5.0	
05	VC	30	0.43	-	25.7	17.1	12.9	10.3	8.6	7.3	6.4	5.7	5.1	4.7	4.3	4.0	3.7	3.4	3.2
	C	40	0.50	-	29.7	19.8	14.9	11.9	9.9	8.5	7.4	6.6	5.9	5.4	5.0	4.6	4.2	4.0	3.7
	M	50	0.56	-	-	22.1	16.6	13.3	11.1	9.5	8.3	7.4	6.6	6.0	5.5	5.1	4.7	4.4	4.2
	M	60	0.61	-	-	24.2	18.2	14.5	12.1	10.4	9.1	8.1	7.3	6.6	6.1	5.6	5.2	4.8	4.5
	M	70	0.66	-	-	26.2	19.6	15.7	13.1	11.2	9.8	8.7	7.9	7.1	6.5	6.0	5.6	5.2	4.9
	M	80	0.71	-	-	28.0	21.0	16.8	14.0	12.0	10.5	9.3	8.4	7.6	7.0	6.5	6.0	5.6	5.3
M	90	0.75	-	-	29.7	-	22.3	17.8	14.9	12.7	11.1	9.9	8.9	8.1	7.4	6.9	6.4	5.9	5.6
M	100	0.79	-	-	-	-	23.5	18.8	15.7	13.4	11.7	10.4	9.4	8.5	7.8	7.2	6.7	6.3	5.9
M	115	0.85	-	-	-	-	25.2	20.1	16.8	14.4	12.6	11.2	10.1	9.2	8.4	7.7	7.2	6.7	6.3
06	XC	30	0.52	-	20.6	15.4	12.3	10.3	8.8	7.7	6.9	6.2	5.6	5.1	4.7	4.4	4.1	3.9	3.9
	C	40	0.60	-	23.8	17.8	14.3	11.9	10.2	8.9	7.9	7.1	6.5	5.9	5.5	5.1	4.8	4.5	4.5
	C	50	0.67	-	26.6	19.9	15.9	13.3	11.4	10.0	8.9	8.0	7.2	6.6	6.1	5.7	5.3	5.0	5.0
	C	60	0.73	-	29.1	21.8	17.5	14.5	12.5	10.9	9.7	8.7	7.9	7.3	6.7	6.2	5.8	5.5	5.5
	M	70	0.79	-	-	23.6	18.9	15.7	13.5	11.8	10.5	9.4	8.6	7.9	7.3	6.7	6.3	5.9	5.9
	M	80	0.85	-	-	25.2	20.2	16.8	14.4	12.6	11.2	10.1	9.2	8.4	7.8	7.2	6.7	6.3	6.3
M	90	0.90	-	-	26.7	21.4	17.8	15.3	13.4	11.9	10.7	9.7	8.9	8.2	7.6	7.1	6.7	6.7	
M	100	0.95	-	-	28.2	22.5	18.8	16.1	14.1	12.5	11.3	10.2	9.4	8.7	8.1	7.5	7.0	7.0	
M	115	1.02	-	-	-	24.2	20.1	17.3	15.1	13.4	12.1	11.0	10.1	9.3	8.6	8.1	7.6	7.6	
08	VC	30	0.69	-	27.4	20.6	16.5	13.7	11.8	10.3	9.1	8.2	7.5	6.9	6.3	5.9	5.5	5.1	5.1
	C	40	0.80	-	23.8	19.0	15.8	13.6	11.9	10.6	9.5	8.6	7.9	7.3	6.8	6.3	5.9	5.5	5.5
	C	50	0.89	-	26.6	21.3	17.7	15.2	13.3	11.8	10.6	9.7	8.9	8.2	7.6	7.1	6.6	6.3	6.3
	C	60	0.98	-	29.1	23.3	19.4	16.6	14.5	12.9	11.6	10.6	9.7	9.0	8.3	7.8	7.3	6.8	6.7
	M	70	1.06	-	-	25.2	21.0	18.0	15.7	14.0	12.6	11.4	10.5	9.7	9.0	8.4	7.9	7.4	7.4
	M	80	1.13	-	-	26.9	22.4	19.2	16.8	14.9	13.4	12.2	11.2	10.3	9.6	9.0	8.4	7.9	7.9
M	90	1.20	-	-	28.5	23.8	20.4	17.8	15.8	14.3	13.0	11.9	11.0	10.2	9.5	8.9	8.4	8.4	
M	100	1.26	-	-	-	25.0	21.5	18.8	16.7	15.0	13.7	12.5	11.6	10.7	10.0	9.4	8.9	8.9	
M	115	1.36	-	-	-	26.9	23.0	20.1	17.9	16.1	14.6	13.4	12.4	11.5	10.7	10.0	9.4	9.4	

Droplet size based on ASABE S572.1 standard.

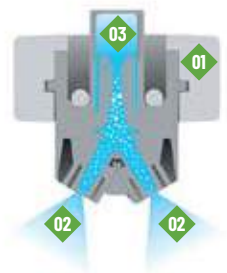

01. Integrated Locking Collar allows for precise and easy installation
02. Twin Air Induced spray patterns (30° offset) for superior coverage
03. Available with or without filter options



110° air inducted spray pattern for class leading coverage on a variety of targets.



Sturdy twin 30° incline/decline patterns provide superior canopy penetration through pattern integrity.



Z.N.T.

See <http://pentair.com/certifications> for the latest drift reduction standard information.

METRIC UNITS

Nozzle Size	Droplet Size	Pressure (BAR)	Flow Rate (LPM)	Application Rate L/Ha - 50 cm Spacing							Drift Reduction Standards			
				KM/H							LERAP	JKI	Z.N.T.	
				7	8	10	12	15	20	25				30
02	C	2	0.65	111	98	78	65	52	39	31	26	★★ 50-75% 2.0-2.25 BAR ★ 25-50% 2.25-2.5 BAR		66% 2.0-2.5 BAR
	M	3	0.80	137	120	96	80	64	48	38	32			
	M	4	0.92	158	138	110	92	74	55	44	37			
	M	5	1.03	177	155	124	103	82	62	49	41			
	M	6	1.13	194	170	136	113	90	68	54	45			
	F	7	1.22	209	183	146	122	98	73	59	49			
F	8	1.31	225	197	157	131	105	79	63	52				
025	UC	2	0.82	141	123	98	82	66	49	39	33	★★ 50-75% 2.0-2.25 BAR ★ 25-50% 2.25-2.5 BAR	50% 2.0-2.5 BAR Ref # G-1872	66% 2.0-2.5 BAR
	VC	3	1.00	171	150	120	100	80	60	48	40			
	M	4	1.15	197	173	138	115	92	69	55	46			
	M	5	1.29	221	194	155	129	103	77	62	52			
	M	6	1.41	242	212	169	141	113	85	68	56			
	M	7	1.53	262	230	184	153	122	92	73	61			
M	8	1.63	279	245	196	163	130	98	78	65				
03	VC	2	0.98	168	147	118	98	78	59	47	39	★★ 50-75% 2.0-3.0 BAR ★ 25-50% 3.0-4.0 BAR	50% 2.0-3.0 BAR Ref # G-1874	66% 2.0-3.0 BAR
	C	3	1.20	206	180	144	120	96	72	58	48			
	M	4	1.39	238	209	167	139	111	83	67	56			
	M	5	1.55	266	233	186	155	124	93	74	62			
	M	6	1.70	291	255	204	170	136	102	82	68			
	M	7	1.83	314	275	220	183	146	110	88	73			
M	8	1.96	336	294	235	196	157	118	94	78				
035	XC	2	1.14	195	171	137	114	91	68	55	46	★★ 50-75% 2.0-2.5 BAR	75% 1.5-2.0 BAR 50% 2.1-3.0 BAR Ref # G-1988	
	C	3	1.40	240	210	168	140	112	84	67	56			
	M	4	1.62	278	243	194	162	130	97	78	65			
	M	5	1.81	310	272	217	181	145	109	87	72			
	M	6	1.98	339	297	238	198	158	119	95	79			
	M	7	2.14	367	321	257	214	171	128	103	86			
M	8	2.29	393	344	275	229	183	137	110	92				
04	VC	2	1.21	225	197	157	131	105	79	63	52	★ 25-50% 2.0-3.0 BAR	50% 2.0-2.5 BAR Ref # G-1875	66% 2.0-3.0 BAR
	C	3	1.60	274	240	192	160	128	96	77	64			
	M	4	1.85	317	278	222	185	148	111	89	74			
	M	5	2.07	355	311	248	207	166	124	99	83			
	M	6	2.26	387	339	271	226	181	136	108	90			
	M	7	2.44	418	366	293	244	195	146	117	98			
M	8	2.61	447	392	313	261	209	157	125	104				
05	VC	2	1.63	279	245	196	163	130	98	78	65	★★ 50-75% 2.0-3.0 BAR ★ 25-50% 3.0-3.5 BAR	50% 2.0-3.0 BAR Ref # G-1876	66% 2.0-3.0 BAR
	C	3	2.00	343	300	240	200	160	120	96	80			
	M	4	2.31	396	347	277	231	185	139	111	92			
	M	5	2.58	442	387	310	258	206	155	124	103			
	M	6	2.83	485	425	340	283	226	170	136	113			
	M	7	3.06	525	459	367	306	245	184	147	122			
M	8	3.27	561	491	392	327	262	196	157	131				
06	C	2	1.96	336	294	235	196	157	118	94	78	★★ 50-75% 2.0-3.0 BAR ★ 25-50% 3.0-3.5 BAR	50% 2.0-4.0 BAR Ref # G-1877	66% 2.0-3.0 BAR
	C	3	2.40	411	360	288	240	192	144	115	96			
	M	4	2.77	475	416	332	277	222	166	133	111			
	M	5	3.10	531	465	372	310	248	186	149	124			
	M	6	3.39	581	509	407	339	271	203	163	136			
	M	7	3.67	629	551	440	367	294	220	176	147			
M	8	3.92	672	588	470	392	314	235	188	157				
08	VC	2	2.61	447	392	313	261	209	157	125	104	★★ 50-75% 2.0-3.0 BAR ★ 25-50% 3.0-4.0 BAR	50% 2.0-6.0 BAR Ref # G-1878	66% 2.0-3.0 BAR
	C	3	3.20	549	480	384	320	256	192	154	128			
	C	4	3.70	634	555	444	370	296	222	178	148			
	M	5	4.13	708	620	496	413	330	248	198	165			
	M	6	4.53	777	680	544	453	362	272	217	181			
	M	7	4.89	838	734	587	489	391	293	235	196			
M	8	5.23	897	785	628	523	418	314	251	209				

Droplet size based on ASABE S572.1 standard.
Use at 3 bar for optimum coverage.

Features	
Common Use	Plant Health
Pattern	Tapered Flat Fan
Technology	Air Induction
Material	Polyacetal
Spray Angle	110°
Pressure Range	30-115 PSI (2-8 BAR)
Configuration	FastCap Complete
Optimum Boom Height	
15" (35 cm) Spacing	15" (35 cm)
20" (50 cm) Spacing	20" (50 cm)
Part Numbers (Bags of 10)	
FastCaps 110° with filter	FastCaps 110° without filter
GAT110-02	GAT110-02A
GAT110-025	GAT110-025A
GAT110-03	GAT110-03A
GAT110-035	GAT110-035A
GAT110-04	GAT110-04A
GAT110-05	GAT110-05A
GAT110-06	GAT110-06A
GAT110-08	GAT110-08A
Replacement Parts	
TS02-50	50 mesh strainer for all sizes
65-BS205	O-Ring
3003579A	Replaceable cage for non-filter versions

Available for order through HYPRO - EU only (Cambridge, UK)

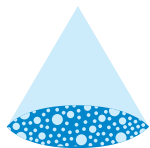

GUARDIANAIR 110°



The Hypro GuardianAIR spray nozzle has a unique rearward spray incline provides more uniform coverage. Higher flow nozzles used at faster speeds have a greater spray incline.

- ◆ Air-induced sprays reduce drift while increasing droplet deposition and retention on foliage
- ◆ Provides better coverage with more drops per gallon or litre compared to other common air-induced spray nozzles
- ◆ Speed-optimized spray incline allows more uniform coverage
- ◆ Specifically engineered nozzle to maintain droplet spectrum regardless of orifice size
- ◆ FastCap includes nozzle, cap and gasket

US UNITS

Nozzle Size	Droplet Size	Pressure (PSI)	Flow Rate (GPM)	Speed (MPH) - 20 inch nozzle spacing															
				Gallons per Acre															
				2.5	5	7.5	10	12.5	15	17.5	20	22.5	25	27.5	30	32.5	35	37.5	40
015	UC	20	0.11	12.6	6.3	4.2	3.2	2.5	2.1	1.8	1.6	1.4	1.3	1.1	1.1	1.0	0.9	0.8	0.8
	XC	30	0.13	15.4	7.7	5.1	3.9	3.1	2.6	2.2	1.9	1.7	1.5	1.4	1.3	1.2	1.1	1.0	1.0
	C	40	0.15	17.8	8.9	5.9	4.5	3.6	3.0	2.5	2.2	2.0	1.8	1.6	1.5	1.4	1.3	1.2	1.1
	C	50	0.17	19.9	10.0	6.6	5.0	4.0	3.3	2.8	2.5	2.2	2.0	1.8	1.7	1.5	1.4	1.3	1.2
	M	60	0.18	21.8	10.9	7.3	5.5	4.4	3.6	3.1	2.7	2.4	2.2	2.0	1.8	1.7	1.6	1.5	1.4
	M	70	0.20	23.6	11.8	7.9	5.9	4.7	3.9	3.4	2.9	2.6	2.4	2.1	2.0	1.8	1.7	1.6	1.5
	M	80	0.21	25.2	12.6	8.4	6.3	5.0	4.2	3.6	3.2	2.8	2.5	2.3	2.1	1.9	1.8	1.7	1.6
	M	90	0.23	26.7	13.4	8.9	6.7	5.3	4.5	3.8	3.3	3.0	2.7	2.4	2.2	2.1	1.9	1.8	1.7
	M	100	0.24	28.2	14.1	9.4	7.0	5.6	4.7	4.0	3.5	3.1	2.8	2.6	2.3	2.2	2.0	1.9	1.8
M	115	0.25	-	15.1	10.1	7.6	6.0	5.0	4.3	3.8	3.4	3.0	2.7	2.5	2.3	2.2	2.0	1.9	
02	XC	20	0.14	16.8	8.4	5.6	4.2	3.4	2.8	2.4	2.1	1.9	1.7	1.5	1.4	1.3	1.2	1.1	1.1
	VC	30	0.17	20.6	10.3	6.9	5.1	4.1	3.4	2.9	2.6	2.3	2.1	1.9	1.7	1.6	1.5	1.4	1.3
	C	40	0.20	23.8	11.9	7.9	5.9	4.8	4.0	3.4	3.0	2.6	2.4	2.2	2.0	1.8	1.7	1.6	1.5
	C	50	0.22	26.6	13.3	8.9	6.6	5.3	4.4	3.8	3.3	3.0	2.7	2.4	2.2	2.0	1.9	1.8	1.7
	M	60	0.24	29.1	14.5	9.7	7.3	5.8	4.8	4.2	3.6	3.2	2.9	2.6	2.4	2.2	2.1	1.9	1.8
	M	70	0.26	-	15.7	10.5	7.9	6.3	5.2	4.5	3.9	3.5	3.1	2.9	2.6	2.4	2.2	2.1	2.0
	M	80	0.28	-	16.8	11.2	8.4	6.7	5.6	4.8	4.2	3.7	3.4	3.1	2.8	2.6	2.4	2.2	2.1
	M	90	0.30	-	17.8	11.9	8.9	7.1	5.9	5.1	4.5	4.0	3.6	3.2	3.0	2.7	2.5	2.4	2.2
	M	100	0.32	-	18.8	12.5	9.4	7.5	6.3	5.4	4.7	4.2	3.8	3.4	3.1	2.9	2.7	2.5	2.3
M	115	0.34	-	20.1	13.4	10.1	8.1	6.7	5.8	5.0	4.5	4.0	3.7	3.4	3.1	2.9	2.7	2.5	
025	XC	20	0.18	21.0	10.5	7.0	5.3	4.2	3.5	3.0	2.6	2.3	2.1	1.9	1.8	1.6	1.5	1.4	1.3
	VC	30	0.22	25.7	12.9	8.6	6.4	5.1	4.3	3.7	3.2	2.9	2.6	2.3	2.1	2.0	1.8	1.7	1.6
	C	40	0.25	29.7	14.9	9.9	7.4	5.9	5.0	4.2	3.7	3.3	3.0	2.7	2.5	2.3	2.1	2.0	1.9
	C	50	0.28	-	16.6	11.1	8.3	6.6	5.5	4.7	4.2	3.7	3.3	3.0	2.8	2.6	2.4	2.2	2.1
	M	60	0.31	-	18.2	12.1	9.1	7.3	6.1	5.2	4.5	4.0	3.6	3.3	3.0	2.8	2.6	2.4	2.3
	M	70	0.33	-	19.6	13.1	9.8	7.9	6.5	5.6	4.9	4.4	3.9	3.6	3.3	3.0	2.8	2.6	2.5
	M	80	0.35	-	21.0	14.0	10.5	8.4	7.0	6.0	5.3	4.7	4.2	3.8	3.5	3.2	3.0	2.8	2.6
	M	90	0.38	-	22.3	14.9	11.1	8.9	7.4	6.4	5.6	5.0	4.5	4.1	3.7	3.4	3.2	3.0	2.8
	M	100	0.40	-	23.5	15.7	11.7	9.4	7.8	6.7	5.9	5.2	4.7	4.3	3.9	3.6	3.4	3.1	2.9
M	115	0.42	-	25.2	16.8	12.6	10.1	8.4	7.2	6.3	5.6	5.0	4.6	4.2	3.9	3.6	3.4	3.1	
03	UC	20	0.21	25.2	12.6	8.4	6.3	5.0	4.2	3.6	3.2	2.8	2.5	2.3	2.1	1.9	1.8	1.7	1.6
	XC	30	0.26	-	15.4	10.3	7.7	6.2	5.1	4.4	3.9	3.4	3.1	2.8	2.6	2.4	2.2	2.1	1.9
	VC	40	0.30	-	17.8	11.9	8.9	7.1	5.9	5.1	4.5	4.0	3.6	3.2	3.0	2.7	2.5	2.4	2.2
	C	50	0.34	-	19.9	13.3	10.0	8.0	6.6	5.7	5.0	4.4	4.0	3.6	3.3	3.1	2.8	2.7	2.5
	C	60	0.37	-	21.8	14.5	10.9	8.7	7.3	6.2	5.5	4.8	4.4	4.0	3.6	3.4	3.1	2.9	2.7
	M	70	0.40	-	23.6	15.7	11.8	9.4	7.9	6.7	5.9	5.2	4.7	4.3	3.9	3.6	3.4	3.1	2.9
	M	80	0.42	-	25.2	16.8	12.6	10.1	8.4	7.2	6.3	5.6	5.0	4.6	4.2	3.9	3.6	3.4	3.2
	M	90	0.45	-	26.7	17.8	13.4	10.7	8.9	7.6	6.7	5.9	5.3	4.9	4.5	4.1	3.8	3.6	3.3
	M	100	0.47	-	28.2	18.8	14.1	11.3	9.4	8.1	7.0	6.3	5.6	5.1	4.7	4.3	4.0	3.8	3.5
M	115	0.51	-	-	20.1	15.1	12.1	10.1	8.6	7.6	6.7	6.0	5.5	5.0	4.6	4.3	4.0	3.8	
04	XC	20	0.28	-	16.8	11.2	8.4	6.7	5.6	4.8	4.2	3.7	3.4	3.1	2.8	2.6	2.4	2.2	2.1
	VC	30	0.35	-	20.6	13.7	10.3	8.2	6.9	5.9	5.1	4.6	4.1	3.7	3.4	3.2	2.9	2.7	2.6
	C	40	0.40	-	23.8	15.8	11.9	9.5	7.9	6.8	5.9	5.3	4.8	4.3	4.0	3.7	3.4	3.2	3.0
	C	50	0.45	-	26.6	17.7	13.3	10.6	8.9	7.6	6.6	5.9	5.3	4.8	4.4	4.1	3.8	3.5	3.3
	M	60	0.49	-	29.1	19.4	14.5	11.6	9.7	8.3	7.3	6.5	5.8	5.3	4.8	4.5	4.2	3.9	3.6
	M	70	0.53	-	-	21.0	15.7	12.6	10.5	9.0	7.9	7.0	6.3	5.7	5.2	4.8	4.5	4.2	3.9
	M	80	0.57	-	-	22.4	16.8	13.4	11.2	9.6	8.4	7.5	6.7	6.1	5.6	5.2	4.8	4.5	4.2
	M	90	0.60	-	-	23.8	17.8	14.3	11.9	10.2	8.9	7.9	7.1	6.5	5.9	5.5	5.1	4.8	4.5
	M	100	0.63	-	-	25.0	18.8	15.0	12.5	10.7	9.4	8.3	7.5	6.8	6.3	5.8	5.4	5.0	4.7
M	115	0.68	-	-	26.9	20.1	16.1	13.4	11.5	10.1	9.0	8.1	7.3	6.7	6.2	5.8	5.4	5.0	
05	XC	20	0.35	-	21.0	14.0	10.5	8.4	7.0	6.0	5.3	4.7	4.2	3.8	3.5	3.2	3.0	2.8	2.6
	XC	30	0.43	-	25.7	17.1	12.9	10.3	8.6	7.3	6.4	5.7	5.1	4.7	4.3	4.0	3.7	3.4	3.2
	C	40	0.50	-	29.7	19.8	14.9	11.9	9.9	8.5	7.4	6.6	5.9	5.4	5.0	4.6	4.2	4.0	3.7
	C	50	0.56	-	-	22.1	16.6	13.3	11.1	9.5	8.3	7.4	6.6	6.0	5.5	5.1	4.7	4.4	4.2
	C	60	0.61	-	-	24.2	18.2	14.5	12.1	10.4	9.1	8.1	7.3	6.6	6.1	5.6	5.2	4.8	4.5
	M	70	0.66	-	-	26.2	19.6	15.7	13.1	11.2	9.8	8.7	7.9	7.1	6.5	6.0	5.6	5.2	4.9
	M	80	0.71	-	-	28.0	21.0	16.8	14.0	12.0	10.5	9.3	8.4	7.6	7.0	6.5	6.0	5.6	5.3
	M	90	0.75	-	-	29.7	22.3	17.8	14.9	12.7	11.1	9.9	8.9	8.1	7.4	6.9	6.4	5.9	5.6
	M	100	0.79	-	-	31.3	23.5	18.8	15.7	13.4	11.7	10.4	9.4	8.5	7.8	7.2	6.7	6.3	5.9
M	115	0.85	-	-	33.6	25.2	20.1	16.8	14.4	12.6	11.2	10.1	9.2	8.4	7.7	7.2	6.7	6.3	

Droplet size based on ASABE S572.1 standard.

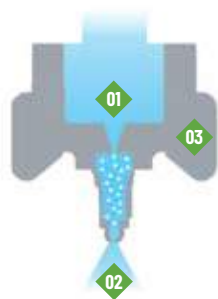

01. Single Inlet; Air Induced Technology
02. Inclined spray pattern provides more uniform coverage
03. Available in a Fastcap option for easy installation



Flexible 110° air inducted spray pattern capable of meeting many spraying situations.



Unique angle of incline specifically engineered to maximize droplet deposition on vertical targets.



See <http://pentair.com/certifications> for the latest drift reduction standard information.

METRIC UNITS

Nozzle Size	Droplet Size	Pressure (BAR)	Flow Rate (LPM)	Application Rate L/Ha -50 cm Spacing							Drift Reduction Standards				
				KM/H							LERAP	JKI	Z.N.T.	TCT	
				7	8	10	12	15	20	25					30
015	UC	1	0.35	60	53	42	35	28	21	17	14	★★★★ 75% + 1.0-1.25 BAR ★★ 50-75% 1.3-2.0 BAR		66% 1.0-2.0 BAR	50% 1.3-2.0 BAR
	UC	1.5	0.42	72	63	50	42	34	25	20	17				
	XC	2	0.49	84	74	59	49	39	29	24	20				
	C	3	0.60	103	90	72	60	48	36	29	24				
	M	4	0.69	118	104	83	69	55	41	33	28				
	M	5	0.77	132	116	92	77	62	46	37	31				
	M	6	0.85	146	128	102	85	68	51	41	34				
	M	7	0.92	158	138	110	92	74	55	44	37				
M	8	0.98	168	147	118	98	78	59	47	39					
02	UC	1	0.46	79	69	55	46	37	28	22	18	★★★★ 75% + 1.0-1.25 BAR ★★ 50-75% 1.3-2.0 BAR	50% 1.0-2.0 BAR Ref # G-1812	66% 1.0-3.0 BAR	50% 1.3-2.0 BAR
	XC	1.5	0.57	98	86	68	57	46	34	27	23				
	VC	2	0.65	111	98	78	65	52	39	31	26				
	M	3	0.80	137	120	96	80	64	48	38	32				
	M	4	0.92	158	138	110	92	74	55	44	37				
	M	5	1.03	177	155	124	103	82	62	49	41				
	M	6	1.13	194	170	136	113	90	68	54	45				
	M	7	1.22	209	183	146	122	98	73	59	49				
M	8	1.31	225	197	157	131	105	79	63	52					
025	UC	1	0.58	99	87	70	58	46	35	28	23	★★★★ 75% + 1.0-1.5 BAR ★★ 50-75% 1.6-2.5 BAR	50% 1.0-2.5 BAR Ref # G-1817	66% 1.0-3.0 BAR	75% 1.0-1.5 BAR 50% 1.6-2.5 BAR
	XC	1.5	0.71	122	107	85	71	57	43	34	28				
	VC	2	0.82	141	123	98	82	66	49	39	33				
	C	3	1.00	171	150	120	100	80	60	48	40				
	M	4	1.15	197	173	138	115	92	69	55	46				
	M	5	1.29	221	194	155	129	103	77	62	52				
	M	6	1.41	242	212	169	141	113	85	68	56				
	M	7	1.53	262	230	184	153	122	92	73	61				
M	8	1.63	279	245	196	163	130	98	78	65					
03	UC	1	0.69	118	104	83	69	55	41	33	28	★★★★ 75% + 1.0-1.5 BAR ★★ 50-75% 1.6-2.5 BAR	75% 1.5 BAR 50% 1.6-2.5 BAR Ref # G-1813	66% 1.0-4.0 BAR	75% 1.0-1.5 BAR 50% 1.6-2.5 BAR
	UC	1.5	0.85	146	128	102	85	68	51	41	34				
	XC	2	0.98	168	147	118	98	78	59	47	39				
	VC	3	1.20	206	180	144	120	96	72	58	48				
	C	4	1.39	238	209	167	139	111	83	67	56				
	M	5	1.55	266	233	186	155	124	93	74	62				
	M	6	1.70	291	255	204	170	136	102	82	68				
	M	7	1.83	314	275	220	183	146	110	88	73				
M	8	1.96	336	294	235	196	157	118	94	78					
04	UC	1	0.92	158	138	110	92	74	55	44	37	★★★★ 75% + 1.0-1.5 BAR ★★ 50-75% 1.6-4.0 BAR	75% 1.0-1.5 BAR 50% 1.6-2.5 BAR Ref # G-1814	66% 1.0-4.0 BAR	75% 1.0-1.5 BAR 50% 1.6-4.0 BAR
	XC	1.5	1.13	194	170	136	113	90	68	54	45				
	VC	2	1.31	225	197	157	131	105	79	63	52				
	C	3	1.60	274	240	192	160	128	96	77	64				
	M	4	1.85	317	278	222	185	148	111	89	74				
	M	5	2.07	355	311	248	207	166	124	99	83				
	M	6	2.26	387	339	271	226	181	136	108	90				
	M	7	2.44	418	366	293	244	195	146	117	98				
M	8	2.61	447	392	313	261	209	157	125	104					
05	UC	1	1.15	197	173	138	115	92	69	55	46	★★★★ 75% + 1.0-1.5 BAR ★★ 50-75% 1.6-4.0 BAR	75% 1.0-1.5 BAR 50% 1.6-2.5 BAR Ref # G-1815	66% 1.0-4.0 BAR	75% 1.0-1.5 BAR 50% 1.6-4.0 BAR
	XC	1.5	1.41	242	212	169	141	113	85	68	56				
	XC	2	1.63	279	245	196	163	130	98	78	65				
	C	3	2.00	343	300	240	200	160	120	96	80				
	C	4	2.31	396	347	277	231	185	139	111	92				
	M	5	2.58	442	387	310	258	206	155	124	103				
	M	6	2.83	485	425	340	283	226	170	136	113				
	M	7	3.06	525	459	367	306	245	184	147	122				
M	8	3.27	561	491	392	327	262	196	157	131					

Droplet size based on ASABE S572.1 standard.
Use at 3 bar for optimum coverage.

Features	
Common Use	Plant Health
Pattern	Tapered Flat Fan
Technology	Air Induction
Material	Polyacetal
Spray Angle	110°
Pressure Range	20-115 PSI (1-8 BAR)
Configuration	Nozzles, FastCap
Optimum Boom Height	
15" (35 cm) Spacing	15" (35 cm)
20" (50 cm) Spacing	20" (50 cm)
Part Numbers (Bags of 10)	
Nozzles 110°	FastCaps 110°
GA110-015	FC-GA110-015
GA110-02	FC-GA110-02
GA110-025	FC-GA110-025
GA110-03	FC-GA110-03
GA110-035	FC-GA110-035
GA110-04	FC-GA110-04
GA110-05	FC-GA110-05
Replacement Cap Gasket	
10BG-2270-0150	

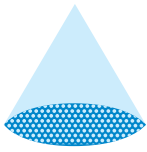

GUARDIAN 120°



Guardian spray nozzles are ideal for insecticide and fungicide applications especially when used with suspension based adjuvants. The Guardian's unique 20° inclined spray pattern allows users to aim the spray rearward for general spraying, forward for vertical targets, or alternate nozzles to create a twin spray.

- ◆ Pre-orifice design for courser spray availability the flat fans
- ◆ PWM system compatible
- ◆ A bold arrow indicates incline direction for easy installation
- ◆ FastCap complete includes nozzle, cap, gasket and integrated strainers

US UNITS

Nozzle Size	Droplet Size	Pressure (PSI)	Flow Rate (GPM)	Speed (MPH) - 20 inch nozzle spacing																
				Gallons per Acre																
				2.5	5	7.5	10	12.5	15	17.5	20	22.5	25	27.5	30	32.5	35	37.5	40	
015	-	20	0.11	12.6	6.3	4.2	3.2	2.5	2.1	1.8	1.6	1.4	1.3	1.1	1.1	1.0	0.9	0.8	0.8	
	M	30	0.13	15.4	7.7	5.1	3.9	3.1	2.6	2.2	1.9	1.7	1.5	1.4	1.3	1.2	1.1	1.0	1.0	
	M	40	0.15	17.8	8.9	5.9	4.5	3.6	3.0	2.5	2.2	2.0	1.8	1.6	1.5	1.4	1.3	1.2	1.1	
	M	50	0.17	19.9	10.0	6.6	5.0	4.0	3.3	2.8	2.5	2.2	2.0	1.8	1.7	1.5	1.4	1.3	1.2	
	M	60	0.18	21.8	10.9	7.3	5.5	4.4	3.6	3.1	2.7	2.4	2.2	2.0	1.8	1.7	1.6	1.5	1.4	
	F	70	0.20	23.6	11.8	7.9	5.9	4.7	3.9	3.4	2.9	2.6	2.4	2.1	2.0	1.8	1.7	1.6	1.5	
	F	80	0.21	25.2	12.6	8.4	6.3	5.0	4.2	3.6	3.2	2.8	2.5	2.3	2.1	1.9	1.8	1.7	1.6	
	F	90	0.23	26.7	13.4	8.9	6.7	5.3	4.5	3.8	3.3	3.0	2.7	2.4	2.2	2.1	1.9	1.8	1.7	
	F	100	0.24	28.2	14.1	9.4	7.0	5.6	4.7	4.0	3.5	3.1	2.8	2.6	2.3	2.2	2.0	1.9	1.8	
	F	115	0.25	-	15.1	10.1	7.6	6.0	5.0	4.3	3.8	3.4	3.0	2.7	2.5	2.3	2.2	2.0	1.9	
	02	-	20	0.14	16.8	8.4	5.6	4.2	3.4	2.8	2.4	2.1	1.9	1.7	1.5	1.4	1.3	1.2	1.1	1.1
		M	30	0.17	20.6	10.3	6.9	5.1	4.1	3.4	2.9	2.6	2.3	2.1	1.9	1.7	1.6	1.5	1.4	1.3
M		40	0.20	23.8	11.9	7.9	5.9	4.8	4.0	3.4	3.0	2.6	2.4	2.2	2.0	1.8	1.7	1.6	1.5	
M		50	0.22	26.6	13.3	8.9	6.6	5.3	4.4	3.8	3.3	3.0	2.7	2.4	2.2	2.0	1.9	1.8	1.7	
M		60	0.24	29.1	14.5	9.7	7.3	5.8	4.8	4.2	3.6	3.2	2.9	2.6	2.4	2.2	2.1	1.9	1.8	
M		70	0.26	-	15.7	10.5	7.9	6.3	5.2	4.5	3.9	3.5	3.1	2.9	2.6	2.4	2.2	2.1	2.0	
M		80	0.28	-	16.8	11.2	8.4	6.7	5.6	4.8	4.2	3.7	3.4	3.1	2.8	2.6	2.4	2.2	2.1	
M		90	0.30	-	17.8	11.9	8.9	7.1	5.9	5.1	4.5	4.0	3.6	3.2	3.0	2.7	2.5	2.4	2.2	
M		100	0.32	-	18.8	12.5	9.4	7.5	6.3	5.4	4.7	4.2	3.8	3.4	3.1	2.9	2.7	2.5	2.3	
F		115	0.34	-	20.1	13.4	10.1	8.1	6.7	5.8	5.0	4.5	4.0	3.7	3.4	3.1	2.9	2.7	2.5	
025		-	20	0.18	21.0	10.5	7.0	5.3	4.2	3.5	3.0	2.6	2.3	2.1	1.9	1.8	1.6	1.5	1.4	1.3
		M	30	0.22	25.7	12.9	8.6	6.4	5.1	4.3	3.7	3.2	2.9	2.6	2.3	2.1	2.0	1.8	1.7	1.6
	M	40	0.25	29.7	14.9	9.9	7.4	5.9	5.0	4.2	3.7	3.3	3.0	2.7	2.5	2.3	2.1	2.0	1.9	
	M	50	0.28	-	16.6	11.1	8.3	6.6	5.5	4.7	4.2	3.7	3.3	3.0	2.8	2.6	2.4	2.2	2.1	
	M	60	0.31	-	18.2	12.1	9.1	7.3	6.1	5.2	4.5	4.0	3.6	3.3	3.0	2.8	2.6	2.4	2.3	
	M	70	0.33	-	19.6	13.1	9.8	7.9	6.5	5.6	4.9	4.4	3.9	3.6	3.3	3.0	2.8	2.6	2.5	
	M	80	0.35	-	21.0	14.0	10.5	8.4	7.0	6.0	5.3	4.7	4.2	3.8	3.5	3.2	3.0	2.8	2.6	
	M	90	0.38	-	22.3	14.9	11.1	8.9	7.4	6.4	5.6	5.0	4.5	4.1	3.7	3.4	3.2	3.0	2.8	
	M	100	0.40	-	23.5	15.7	11.7	9.4	7.8	6.7	5.9	5.2	4.7	4.3	3.9	3.6	3.4	3.1	2.9	
	M	115	0.42	-	25.2	16.8	12.6	10.1	8.4	7.2	6.3	5.6	5.0	4.6	4.2	3.9	3.6	3.4	3.1	
	03	C	20	0.21	25.2	12.6	8.4	6.3	5.0	4.2	3.6	3.2	2.8	2.5	2.3	2.1	1.9	1.8	1.7	1.6
		M	30	0.26	-	15.4	10.3	7.7	6.2	5.1	4.4	3.9	3.4	3.1	2.8	2.6	2.4	2.2	2.1	1.9
M		40	0.30	-	17.8	11.9	8.9	7.1	5.9	5.1	4.5	4.0	3.6	3.2	3.0	2.7	2.5	2.4	2.2	
M		50	0.34	-	19.9	13.3	10.0	8.0	6.6	5.7	5.0	4.4	4.0	3.6	3.3	3.1	2.8	2.7	2.5	
M		60	0.37	-	21.8	14.5	10.9	8.7	7.3	6.2	5.5	4.8	4.4	4.0	3.6	3.4	3.1	2.9	2.7	
M		70	0.40	-	23.6	15.7	11.8	9.4	7.9	6.7	5.9	5.2	4.7	4.3	3.9	3.6	3.4	3.1	2.9	
M		80	0.42	-	25.2	16.8	12.6	10.1	8.4	7.2	6.3	5.6	5.0	4.6	4.2	3.9	3.6	3.4	3.2	
M		90	0.45	-	26.7	17.8	13.4	10.7	8.9	7.6	6.7	5.9	5.3	4.9	4.5	4.1	3.8	3.6	3.3	
M		100	0.47	-	28.2	18.8	14.1	11.3	9.4	8.1	7.0	6.3	5.6	5.1	4.7	4.3	4.0	3.8	3.5	
M		115	0.51	-	-	20.1	15.1	12.1	10.1	8.6	7.6	6.7	6.0	5.5	5.0	4.6	4.3	4.0	3.8	
04		VC	20	0.28	-	16.8	11.2	8.4	6.7	5.6	4.8	4.2	3.7	3.4	3.1	2.8	2.6	2.4	2.2	2.1
		VC	30	0.35	-	20.6	13.7	10.3	8.2	6.9	5.9	5.1	4.6	4.1	3.7	3.4	3.2	2.9	2.7	2.6
	C	40	0.40	-	23.8	15.8	11.9	9.5	7.9	6.8	5.9	5.3	4.8	4.3	4.0	3.7	3.4	3.2	3.0	
	C	50	0.45	-	26.6	17.7	13.3	10.6	8.9	7.6	6.6	5.9	5.3	4.8	4.4	4.1	3.8	3.5	3.3	
	M	60	0.49	-	29.1	19.4	14.5	11.6	9.7	8.3	7.3	6.5	5.8	5.3	4.8	4.5	4.2	3.9	3.6	
	M	70	0.53	-	-	21.0	15.7	12.6	10.5	9.0	7.9	7.0	6.3	5.7	5.2	4.8	4.5	4.2	3.9	
	M	80	0.57	-	-	22.4	16.8	13.4	11.2	9.6	8.4	7.5	6.7	6.1	5.6	5.2	4.8	4.5	4.2	
	M	90	0.60	-	-	23.8	17.8	14.3	11.9	10.2	8.9	7.9	7.1	6.5	5.9	5.5	5.1	4.8	4.5	
	M	100	0.63	-	-	25.0	18.8	15.0	12.5	10.7	9.4	8.3	7.5	6.8	6.3	5.8	5.4	5.0	4.7	
	M	115	0.68	-	-	26.9	20.1	16.1	13.4	11.5	10.1	9.0	8.1	7.3	6.7	6.2	5.8	5.4	5.0	
	05	XC	20	0.35	-	21.0	14.0	10.5	8.4	7.0	6.0	5.3	4.7	4.2	3.8	3.5	3.2	3.0	2.8	2.6
		XC	30	0.43	-	25.7	17.1	12.9	10.3	8.6	7.3	6.4	5.7	5.1	4.7	4.3	4.0	3.7	3.4	3.2
VC		40	0.50	-	29.7	19.8	14.9	11.9	9.9	8.5	7.4	6.6	5.9	5.4	5.0	4.6	4.2	4.0	3.7	
VC		50	0.56	-	-	22.1	16.6	13.3	11.1	9.5	8.3	7.4	6.6	6.0	5.5	5.1	4.7	4.4	4.2	
C		60	0.61	-	-	24.2	18.2	14.5	12.1	10.4	9.1	8.1	7.3	6.6	6.1	5.6	5.2	4.8	4.5	
M		70	0.66	-	-	26.2	19.6	15.7	13.1	11.2	9.8	8.7	7.9	7.1	6.5	6.0	5.6	5.2	4.9	
M		80	0.71	-	-	28.0	21.0	16.8	14.0	12.0	10.5	9.3	8.4	7.6	7.0	6.5	6.0	5.6	5.3	
M		90	0.75	-	-	29.7	22.3	17.8	14.9	12.7	11.1	9.9	8.9	8.1	7.4	6.9	6.4	5.9	5.6	
M		100	0.79	-	-	-	23.5	18.8	15.7	13.4	11.7	10.4	9.4	8.5	7.8	7.2	6.7	6.3	5.9	
F		115	0.85	-	-	-	25.2	20.1	16.8	14.4	12.6	11.2	10.1	9.2	8.4	7.7	7.2	6.7	6.3	
06		XC	20	0.42	-	25.2	16.8	12.6	10.1	8.4	7.2	6.3	5.6	5.0	4.6	4.2	3.9	3.6	3.4	3.2
		XC	30	0.52	-	-	20.6	15.4	12.3	10.3	8.8	7.7	6.9	6.2	5.6	5.1	4.7	4.4	4.1	3.9
	VC	40	0.60	-	-	23.8	17.8	14.3	11.9	10.2	8.9	7.9	7.1	6.5	5.9	5.5	5.1	4.8	4.5	
	VC	50	0.67	-	-	26.6	19.9	15.9	13.3	11.4	10.0	8.9	8.0	7.2	6.6	6.1	5.7	5.3	5.0	
	C	60	0.73	-	-	29.1	21.8	17.5	14.5	12.5	10.9	9.7	8.7	7.9	7.3	6.7	6.2	5.8	5.5	
	M	70	0.79	-	-	-	23.6	18.9	15.7	13.5	11.8	10.5	9.4	8.6	7.9	7.3	6.7	6.3	5.9	
	M	80	0.85	-	-</															

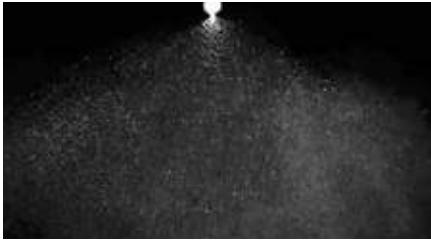

120° wide, non-air induced spray pattern for superior coverage in many spraying applications.

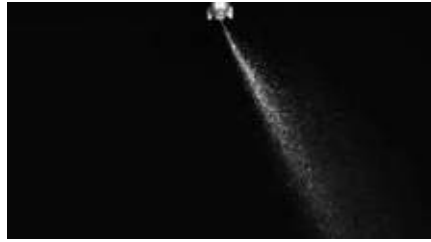

20° pattern incline; alternate nozzles for a twin spray pattern, excellent for suspension based tank mixes.

METRIC UNITS

Nozzle Size	Droplet Size	Pressure (BAR)	Flow Rate (LPM)	Application Rate L/Ha -50 cm Spacing							
				KM/H							
				7	8	10	12	15	20	25	30
015	-	1,5	0,42	72	63	50	42	34	25	20	17
	M	2	0,49	84	74	59	49	39	29	24	20
	M	3	0,60	103	90	72	60	48	36	29	24
	M	4	0,69	118	104	83	69	55	41	33	28
	F	5	0,77	132	116	92	77	62	46	37	31
	F	6	0,85	146	128	102	85	68	51	41	34
	F	7	0,92	158	138	110	92	74	55	44	37
	F	8	0,98	168	147	118	98	78	59	47	39
02	-	1,5	0,57	98	86	68	57	46	34	27	23
	M	2	0,65	111	98	78	65	52	39	31	26
	M	3	0,80	137	120	96	80	64	48	38	32
	M	4	0,92	158	138	110	92	74	55	44	37
	M	5	1,03	177	155	124	103	82	62	49	41
	M	6	1,13	194	170	136	113	90	68	54	45
	M	7	1,22	209	183	146	122	98	73	59	49
	F	8	1,31	225	197	157	131	105	79	63	52
025	-	1,5	0,71	122	107	85	71	57	43	34	28
	M	2	0,82	141	123	98	82	66	49	39	33
	M	3	1,00	171	150	120	100	80	60	48	40
	M	4	1,15	197	173	138	115	92	69	55	46
	M	5	1,29	221	194	155	129	103	77	62	52
	M	6	1,41	242	212	169	141	113	85	68	56
	M	7	1,53	262	230	184	153	122	92	73	61
	M	8	1,63	279	245	196	163	130	98	78	65
03	C	1,5	0,85	146	128	102	85	68	51	41	34
	M	2	0,98	168	147	118	98	78	59	47	39
	M	3	1,20	206	180	144	120	96	72	58	48
	M	4	1,39	238	209	167	139	111	83	67	56
	M	5	1,55	266	233	186	155	124	93	74	62
	M	6	1,70	291	255	204	170	136	102	82	68
	M	7	1,83	314	275	220	183	146	110	88	73
	M	8	1,96	336	294	235	196	157	119	94	78
04	VC	1,5	1,13	194	170	136	113	90	68	54	45
	VC	2	1,31	225	197	157	131	105	79	63	52
	C	3	1,60	274	240	192	160	128	96	77	64
	C	4	1,85	317	278	222	185	148	111	89	74
	M	5	2,07	355	311	248	207	166	124	99	83
	M	6	2,26	387	339	271	226	181	136	108	90
	M	7	2,44	418	366	293	244	195	146	117	98
	M	8	2,61	447	392	313	261	209	157	125	104
05	XC	1,5	1,41	242	212	169	141	113	85	68	56
	XC	2	1,63	279	245	196	163	130	98	78	65
	VC	3	2,00	343	300	240	200	160	120	96	80
	C	4	2,31	396	347	277	231	185	139	111	92
	M	5	2,58	442	387	310	258	206	155	124	103
	M	6	2,83	485	425	340	283	226	170	136	113
	M	7	3,06	525	459	367	306	245	184	147	122
	F	8	3,27	561	491	392	327	262	196	157	131
06	XC	1,5	1,70	291	255	204	170	136	102	82	68
	XC	2	1,96	336	294	235	196	157	118	94	78
	VC	3	2,40	411	360	288	240	192	144	115	96
	C	4	2,77	475	416	332	277	222	166	133	111
	M	5	3,10	531	465	372	310	248	186	149	124
	M	6	3,39	581	509	407	339	271	203	163	136
	M	7	3,67	629	551	440	367	294	220	176	147
	M	8	3,92	672	588	470	392	314	235	188	157
08	XC	1,5	2,26	387	339	271	226	181	136	108	90
	VC	2	2,61	447	392	313	261	209	157	125	104
	C	3	3,20	549	480	384	320	256	192	154	128
	M	4	3,70	634	555	444	370	296	222	178	148
	M	5	4,13	708	620	496	413	330	248	198	165
	M	6	4,53	777	680	544	453	362	272	217	181
	F	7	4,89	838	734	587	489	391	293	235	196
	F	8	5,23	897	785	628	523	418	314	251	209

Droplet size based on ASABE S572.1 standard.

Features	
Common Use	Plant Health
Pattern	Tapered Flat Fan
Technology	Pre-Orifice
Material	Polyacetal
Spray Angle	120°
Pressure Range	20-115 PSI (1-8 BAR)
Configuration	FastCap Complete
Optimum Boom Height	
15' (35 cm) Spacing	15' (35 cm)
20' (50 cm) Spacing	20' (50 cm)
Part Numbers	
FastCaps 120°	
	GRD120-015
	GRD120-02
	GRD120-025
	GRD120-03
	GRD120-04
	GRD120-05
	GRD120-06
	GRD120-08
Replacement Nozzle Strainer	
TS02-100	100 mesh strainer for size 015-03
TS02-50	50 mesh strainer for size 04-08
Replacement Cap Gasket	
	10BG-2270-0150

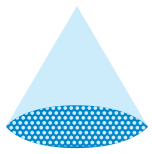

LO-DRIFT 80° & 110°



The Lo-Drift is the original drift-reducing nozzle. The special two-part construction includes a pre-orifice, which reduces the number of drift prone droplets.

- ◆ Significantly reduces spray drift, widening the operational window
- ◆ Balanced droplet size for effective, on-target spray
- ◆ PWM system compatible

US UNITS

Nozzle Size	Droplet Size		Pressure (PSI)	Flow Rate (GPM)	Gallons per Acre 20 inch nozzle spacing										GAL/1000 Ft ² 20 inch nozzle spacing			
	80°	110°			MPH										2	3	4	5
					4	5	6	8	10	12	15	20						
015	M	M	20	0.11	8.2	6.5	5.4	4.1	3.3	2.7	2.2	1.6	0.38	0.25	0.19	0.15		
	M	M	30	0.13	9.7	7.7	6.4	4.8	3.9	3.2	2.6	1.9	0.44	0.30	0.22	0.18		
	M	M	40	0.15	11.1	8.9	7.4	5.6	4.5	3.7	3.0	2.2	0.51	0.34	0.26	0.20		
	M	F	50	0.17	12.6	10.1	8.4	6.3	5.0	4.2	3.4	2.5	0.58	0.39	0.29	0.23		
	M	F	60	0.18	13.4	10.7	8.9	6.7	5.3	4.5	3.6	2.7	0.61	0.41	0.31	0.25		
	M	F	70	0.20	14.9	11.9	9.9	7.4	5.9	5.0	4.0	3.0	0.68	0.45	0.34	0.27		
02	C	M	20	0.14	10.4	8.3	6.9	5.2	4.2	3.5	2.8	2.1	0.48	0.32	0.24	0.19		
	C	M	30	0.17	12.6	10.1	8.4	6.3	5.0	4.2	3.4	2.5	0.58	0.39	0.29	0.23		
	M	F	40	0.20	14.9	11.9	9.9	7.4	5.9	5.0	4.0	3.0	0.68	0.45	0.34	0.27		
	M	F	50	0.22	16.3	13.1	10.9	8.2	6.5	5.4	4.4	3.3	0.75	0.50	0.38	0.30		
	M	F	60	0.24	17.8	14.3	11.9	8.9	7.1	5.9	4.8	3.6	0.82	0.55	0.41	0.33		
	M	F	70	0.26	19.3	15.4	12.9	9.7	7.7	6.4	5.1	3.9	0.89	0.59	0.44	0.35		
025	-	M	20	0.18	13.4	10.7	8.9	6.7	5.3	4.5	3.6	2.7	0.61	0.41	0.31	0.25		
	-	M	30	0.22	16.3	13.1	10.9	8.2	6.5	5.4	4.4	3.3	0.75	0.50	0.38	0.30		
	-	M	40	0.25	18.6	14.9	12.4	9.3	7.4	6.2	5.0	3.7	0.85	0.57	0.43	0.34		
	-	M	50	0.28	20.8	16.6	13.9	10.4	8.3	6.9	5.5	4.2	0.95	0.64	0.48	0.38		
	-	M	60	0.31	23.0	18.4	15.3	11.5	9.2	7.7	6.1	4.6	1.06	0.70	0.53	0.42		
	-	M	70	0.33	24.5	19.6	16.3	12.3	9.8	8.2	6.5	4.9	1.13	0.75	0.56	0.45		
03	C	C	20	0.21	15.6	12.5	10.4	7.8	6.2	5.2	4.2	3.1	0.72	0.48	0.36	0.29		
	C	C	30	0.26	19.3	15.4	12.9	9.7	7.7	6.4	5.1	3.9	0.89	0.59	0.44	0.35		
	C	M	40	0.30	22.3	17.8	14.9	11.1	8.9	7.4	5.9	4.5	1.02	0.68	0.51	0.41		
	M	M	50	0.34	25.2	20.2	16.8	12.6	10.1	8.4	6.7	5.0	1.16	0.77	0.58	0.46		
	M	M	60	0.37	27.5	22.0	18.3	13.7	11.0	9.2	7.3	5.5	1.26	0.84	0.63	0.50		
	M	M	70	0.40	29.7	23.8	19.8	14.9	11.9	9.9	7.9	5.9	1.36	0.91	0.68	0.55		
04	C	C	20	0.28	20.8	16.6	13.9	10.4	8.3	6.9	5.5	4.2	0.95	0.64	0.48	0.38		
	C	M	30	0.35	26.0	20.8	17.3	13.0	10.4	8.7	6.9	5.2	1.19	0.80	0.60	0.48		
	C	M	40	0.40	29.7	23.8	19.8	14.9	11.9	9.9	7.9	5.9	1.36	0.91	0.68	0.55		
	M	M	50	0.45	33.4	26.7	22.3	16.7	13.4	11.1	8.9	6.7	1.53	1.02	0.77	0.61		
	M	M	60	0.49	36.4	29.1	24.3	18.2	14.6	12.1	9.7	7.3	1.67	1.11	0.84	0.67		
	M	M	70	0.53	39.4	31.5	26.2	19.7	15.7	13.1	10.5	7.9	1.81	1.20	0.90	0.72		
05	C	C	20	0.35	26.0	20.8	17.3	13.0	10.4	8.7	6.9	5.2	1.19	0.80	0.60	0.48		
	C	C	30	0.43	31.9	25.5	21.3	16.0	12.8	10.6	8.5	6.4	1.47	0.98	0.73	0.59		
	C	M	40	0.50	37.1	29.7	24.8	18.6	14.9	12.4	9.9	7.4	1.71	1.14	0.85	0.68		
	C	M	50	0.56	41.6	33.3	27.7	20.8	16.6	13.9	11.1	8.3	1.91	1.27	0.95	0.76		
	C	M	60	0.61	45.3	36.2	30.2	22.6	18.1	15.1	12.1	9.1	2.08	1.39	1.04	0.83		
	M	F	70	0.66	49.0	39.2	32.7	24.5	19.6	16.3	13.1	9.8	2.25	1.50	1.13	0.90		
06	VC	VC	20	0.42	31.2	24.9	20.8	15.6	12.5	10.4	8.3	6.2	1.43	0.95	0.72	0.57		
	VC	C	30	0.52	38.6	30.9	25.7	19.3	15.4	12.9	10.3	7.7	1.77	1.18	0.89	0.71		
	C	M	40	0.60	44.6	35.6	29.7	22.3	17.8	14.9	11.9	8.9	2.05	1.36	1.02	0.82		
	C	M	50	0.67	49.7	39.8	33.2	24.9	19.9	16.6	13.3	9.9	2.28	1.52	1.14	0.91		
	C	M	60	0.73	54.2	43.4	36.1	27.1	21.7	18.1	14.5	10.8	2.49	1.66	1.24	1.00		
	C	M	70	0.79	58.7	46.9	39.1	29.3	23.5	19.6	15.6	11.7	2.69	1.80	1.35	1.08		
08	XC	VC	20	0.57	42.3	33.9	28.2	21.2	16.9	14.1	11.3	8.5	1.94	1.30	0.97	0.78		
	VC	C	30	0.69	51.2	41.0	34.2	25.6	20.5	17.1	13.7	10.2	2.35	1.57	1.18	0.94		
	VC	C	40	0.80	59.4	47.5	39.6	29.7	23.8	19.8	15.8	11.9	2.73	1.82	1.36	1.09		
	C	M	50	0.89	66.1	52.9	44.1	33.0	26.4	22.0	17.6	13.2	3.03	2.02	1.52	1.21		
	C	M	60	0.98	72.8	58.2	48.5	36.4	29.1	24.3	19.4	14.6	3.34	2.23	1.67	1.34		
	C	M	70	1.06	78.7	63.0	52.5	39.4	31.5	26.2	21.0	15.7	3.61	2.41	1.81	1.45		

Droplet size based on ASABE S572.1 standard.

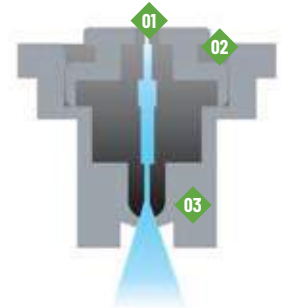

01. Non-Air Inducted; Pre-orifice design for excellent performance with suspension solutions
02. Dual component construction
Material: Polyacetal



110° wide, drift reducing design that is excellent for suspension based tank mixes.



Pre-orifice design limits the formation of small droplets; reducing drift potential with a medium droplet spectrum.



See <http://pentair.com/certifications> for the latest drift reduction standard information.

METRIC UNITS

Nozzle Size	ASABE Droplet Size		Pressure (BAR)	Flow Rate (LPM)	Application Rate L/Ha - 50 cm spacing KM/H								Drift Reduction Standards
	80°	110°			7	8	10	12	15	20	25	30	LERAP
015	M	M	2	0.49	84	74	59	49	39	29	24	20	
	M	M	3	0.60	103	90	72	60	48	36	29	24	
	M	F	4	0.69	118	104	83	69	55	41	33	28	
02	C	M	2	0.65	111	98	78	65	52	39	31	26	
	M	F	3	0.80	137	120	96	80	64	48	38	32	
	M	F	4	0.92	158	138	110	92	74	55	44	37	
025	-	M	2	0.82	141	123	98	82	66	49	39	33	
	-	M	3	1.00	171	150	120	100	80	60	48	40	
	-	F	4	1.15	197	173	138	115	92	69	55	46	
03	C	M	2	0.98	168	147	118	98	78	59	47	39	
	C	M	3	1.20	206	180	144	120	96	72	58	48	
	M	M	4	1.39	238	209	167	139	111	83	67	56	
04	C	M	2	1.31	225	197	157	131	105	79	63	52	
	C	M	3	1.60	274	240	192	160	128	96	77	64	
	M	M	4	1.85	317	278	222	185	148	111	89	74	
05	C	C	2	1.63	279	245	196	163	130	98	78	65	
	C	M	3	2.00	343	300	240	200	160	120	96	80	
	C	M	4	2.31	396	347	277	231	185	139	111	92	
06	VC	C	2	1.96	336	294	235	196	157	118	94	78	★★★ 75% + 2.0-3.0 BAR
	C	M	3	2.40	411	360	288	240	192	144	115	96	
	C	M	4	2.77	475	416	332	277	222	166	133	111	
08	VC	C	2	2.61	447	392	313	261	209	157	125	104	
	VC	C	3	3.20	549	480	384	320	256	192	154	128	
	C	M	4	3.70	634	555	444	370	296	222	178	148	

Droplet size based on ASABE S572.1 standard.

Features	
Common Use	Plant Health
Pattern	Tapered Flat Fan
Technology	Pre-Orifice
Material	Polyacetal
Spray Angle	80° & 110°
Pressure Range	20-70 PSI (1-5 BAR)
Configuration	Nozzles, FastCap
Optimum Boom Height	
80° - 15" (35 cm) Spacing	22" (56 cm)
80° - 20" (50 cm) Spacing	30" (76 cm)
110° - 15" (35 cm) Spacing	15" (35 cm)
110° - 20" (50 cm) Spacing	20" (50 cm)
Part Numbers	
Nozzles 80°	Caps (25 Packs)
LD80-015	CAP00-015
LD80-02	CAP00-02
LD80-03	CAP00-03
LD80-04	CAP00-04
LD80-05	CAP00-05
LD80-06	CAP00-06
LD80-08	CAP00-08
Nozzles 110°	Caps (25 Packs)
LD110-015	CAP00-015
LD110-02	CAP00-02
LD110-025*	CAP00-025
LD110-03	CAP00-03
LD110-04*	CAP00-04
LD110-05*	CAP00-05
LD110-06*	CAP00-06
LD110-08	CAP00-08

*Approved by JKI

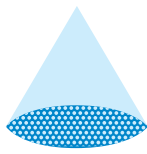

VARIABLE PRESSURE 80° & 110°

Variable Pressure nozzle maintain a consistent spray angle over a wide pressure range down to 20 PSI (1 BAR) and are available in 80° and 110° versions to work with different boom heights.



- Adjustable droplet size according to pressure
- Maintains good spray distribution and makes larger droplets at low pressures
- FastCap includes nozzle, cap and gasket
- Excellent nozzle for a wide variety of herbicide and insecticide applications
- PWM system compatible

US UNITS

Nozzle Size	Droplet Size		Pressure (PSI)	Flow Rate (GPM)	Gallons per Acre 20 inch nozzle spacing										GAL/1000ft ² 20 inch nozzle spacing				
	80°	110°			MPH										2	3	4	5	
015	-	-	20	0.11	8.2	6.5	5.4	4.1	3.3	2.7	2.2	1.6	0.38	0.25	0.19	0.15			
	F	F	30	0.13	9.7	7.7	6.4	4.8	3.9	3.2	2.6	1.9	0.44	0.30	0.22	0.18			
	F	F	40	0.15	11.1	8.9	7.4	5.6	4.5	3.7	3.0	2.2	0.51	0.34	0.26	0.20			
	F	F	50	0.17	12.6	10.1	8.4	6.3	5.0	4.2	3.4	2.5	0.58	0.39	0.29	0.23			
	F	F	60	0.18	13.4	10.7	8.9	6.7	5.3	4.5	3.6	2.7	0.61	0.41	0.31	0.25			
	VF	VF	70	0.20	14.9	11.9	9.9	7.4	5.9	5.0	4.0	3.0	0.68	0.45	0.34	0.27			
02	-	-	20	0.14	10.4	8.3	6.9	5.2	4.2	3.5	2.8	2.1	0.48	0.32	0.24	0.19			
	F	F	30	0.17	12.6	10.1	8.4	6.3	5.0	4.2	3.4	2.5	0.58	0.39	0.29	0.23			
	F	F	40	0.20	14.9	11.9	9.9	7.4	5.9	5.0	4.0	3.0	0.68	0.45	0.34	0.27			
	F	F	50	0.22	16.3	13.1	10.9	8.2	6.5	5.4	4.4	3.3	0.75	0.50	0.38	0.30			
	F	F	60	0.24	17.8	14.3	11.9	8.9	7.1	5.9	4.8	3.6	0.82	0.55	0.41	0.33			
	F	F	70	0.26	19.3	15.4	12.9	9.7	7.7	6.4	5.1	3.9	0.89	0.59	0.44	0.35			
025	-	M	20	0.18	13.4	10.7	8.9	6.7	5.3	4.5	3.6	2.7	0.61	0.41	0.31	0.25			
	-	F	30	0.22	16.3	13.1	10.9	8.2	6.5	5.4	4.4	3.3	0.75	0.50	0.38	0.30			
	-	F	40	0.25	18.6	14.9	12.4	9.3	7.4	6.2	5.0	3.7	0.85	0.57	0.43	0.34			
	-	F	50	0.28	20.8	16.6	13.9	10.4	8.3	6.9	5.5	4.2	0.95	0.64	0.48	0.38			
	-	F	60	0.31	23.0	18.4	15.3	11.5	9.2	7.7	6.1	4.6	1.06	0.70	0.53	0.42			
	-	F	70	0.33	24.5	19.6	16.3	12.3	9.8	8.2	6.5	4.9	1.13	0.75	0.56	0.45			
03	M	M	20	0.21	15.6	12.5	10.4	7.8	6.2	5.2	4.2	3.1	0.72	0.48	0.36	0.29			
	F	F	30	0.26	19.3	15.4	12.9	9.7	7.7	6.4	5.1	3.9	0.89	0.59	0.44	0.35			
	F	F	40	0.30	22.3	17.8	14.9	11.1	8.9	7.4	5.9	4.5	1.02	0.68	0.51	0.41			
	F	F	50	0.34	25.2	20.2	16.8	12.6	10.1	8.4	6.7	5.0	1.16	0.77	0.58	0.46			
	F	F	60	0.37	27.5	22.0	18.3	13.7	11.0	9.2	7.3	5.5	1.26	0.84	0.63	0.50			
	F	F	70	0.40	29.7	23.8	19.8	14.9	11.9	9.9	7.9	5.9	1.36	0.91	0.68	0.55			
035	-	M	20	0.25	18.6	14.9	12.4	9.3	7.4	6.2	5.0	3.7	0.85	0.57	0.43	0.34			
	-	M	30	0.30	22.3	17.8	14.9	11.1	8.9	7.4	5.9	4.5	1.02	0.68	0.51	0.41			
	-	F	40	0.35	26.0	20.8	17.3	13.0	10.4	8.7	6.9	5.2	1.19	0.80	0.60	0.48			
	-	F	50	0.39	29.0	23.2	19.3	14.5	11.6	9.7	7.7	5.8	1.33	0.89	0.66	0.53			
	-	F	60	0.43	31.9	25.5	21.3	16.0	12.8	10.6	8.5	6.4	1.47	0.98	0.73	0.59			
	-	F	70	0.46	34.2	27.3	22.8	17.1	13.7	11.4	9.1	6.8	1.57	1.05	0.78	0.63			
04	C	M	20	0.28	20.8	16.6	13.9	10.4	8.3	6.9	5.5	4.2	0.95	0.64	0.48	0.38			
	M	M	30	0.35	26.0	20.8	17.3	13.0	10.4	8.7	6.9	5.2	1.19	0.80	0.60	0.48			
	F	F	40	0.40	29.7	23.8	19.8	14.9	11.9	9.9	7.9	5.9	1.36	0.91	0.68	0.55			
	F	F	50	0.45	33.4	26.7	22.3	16.7	13.4	11.1	8.9	6.7	1.53	1.02	0.77	0.61			
	F	F	60	0.49	36.4	29.1	24.3	18.2	14.6	12.1	9.7	7.3	1.67	1.11	0.84	0.67			
	F	F	70	0.53	39.4	31.5	26.2	19.7	15.7	13.1	10.5	7.9	1.81	1.20	0.90	0.72			
05	C	M	20	0.35	26.0	20.8	17.3	13.0	10.4	8.7	6.9	5.2	1.19	0.80	0.60	0.48			
	C	M	30	0.43	31.9	25.5	21.3	16.0	12.8	10.6	8.5	6.4	1.47	0.98	0.73	0.59			
	M	F	40	0.50	37.1	29.7	24.8	18.6	14.9	12.4	9.9	7.4	1.71	1.14	0.85	0.68			
	M	F	50	0.56	41.6	33.3	27.7	20.8	16.6	13.9	11.1	8.3	1.91	1.27	0.95	0.76			
	M	F	60	0.61	45.3	36.2	30.2	22.6	18.1	15.1	12.1	9.1	2.08	1.39	1.04	0.83			
	M	F	70	0.66	49.0	39.2	32.7	24.5	19.6	16.3	13.1	9.8	2.25	1.50	1.13	0.90			
06	C	M	20	0.42	31.2	24.9	20.8	15.6	12.5	10.4	8.3	6.2	1.43	0.95	0.72	0.57			
	C	M	30	0.52	38.6	30.9	25.7	19.3	15.4	12.9	10.3	7.7	1.77	1.18	0.89	0.71			
	M	M	40	0.60	44.6	35.6	29.7	22.3	17.8	14.9	11.9	8.9	2.05	1.36	1.02	0.82			
	M	F	50	0.67	49.7	39.8	33.2	24.9	19.9	16.6	13.3	9.9	2.28	1.52	1.14	0.91			
	M	F	60	0.73	54.2	43.4	36.1	27.1	21.7	18.1	14.5	10.8	2.49	1.66	1.24	1.00			
	M	F	70	0.79	58.7	46.9	39.1	29.3	23.5	19.6	15.6	11.7	2.69	1.80	1.35	1.08			
08	-	C	20	0.57	42.3	33.9	28.2	21.2	16.9	14.1	11.3	8.5	1.94	1.30	0.97	0.78			
	-	M	30	0.69	51.2	41.0	34.2	25.6	20.5	17.1	13.7	10.2	2.35	1.57	1.18	0.94			
	-	M	40	0.80	59.4	47.5	39.6	29.7	23.8	19.8	15.8	11.9	2.73	1.82	1.36	1.09			
	-	M	50	0.89	66.1	52.9	44.1	33.0	26.4	22.0	17.6	13.2	3.03	2.02	1.52	1.21			
	-	M	60	0.98	72.8	58.2	48.5	36.4	29.1	24.3	19.4	14.6	3.34	2.23	1.67	1.34			
	-	F	70	1.06	78.7	63.0	52.5	39.4	31.5	26.2	21.0	15.7	3.61	2.41	1.81	1.45			
10	-	C	20	0.71	52.7	42.2	35.1	26.4	21.1	17.6	14.1	10.5	2.42	1.61	1.21	0.97			
	-	M	30	0.87	64.6	51.7	43.1	32.3	25.8	21.5	17.2	12.9	2.97	1.98	1.48	1.19			
	-	M	40	1.00	74.3	59.4	49.5	37.1	29.7	24.8	19.8	14.9	3.41	2.27	1.71	1.36			
	-	M	50	1.12	83.2	66.5	55.4	41.6	33.3	27.7	22.2	16.6	3.82	2.55	1.91	1.53			
	-	M	60	1.22	90.6	72.5	60.4	45.3	36.2	30.2	24.2	18.1	4.16	2.77	2.08	1.66			
	-	F	70	1.32	98.0	78.4	65.3	49.0	39.2	32.7	26.1	19.6	4.50	3.00	2.25	1.80			
15	-	C	20	1.06	78.7	63.0	52.5	39.4	31.5	26.2	21.0	15.7	3.61	2.41	1.81	1.45			
	-	C	30	1.30	96.5	77.2	64.4	48.3	38.6	32.2	25.7	19.3	4.43	2.96	2.22	1.77			
	-	M	40	1.50	111	89.1	74.3	55.7	44.6	37.1	29.7	22.3	5.12	3.41	2.56	2.05			
	-	M	50	1.68	125	99.8	83.2	62.4	49.9	41.6	33.3	24.9	5.73	3.82	2.86	2.29			
	-	M	60	1.84	137	109	91.1	68.3	54.6	45.5	36.4	27.3	6.27	4.18	3.14	2.51			
	-	M	70	1.98	147	118	98.0	73.5	58.8	49.0	39.2	29.4	6.75	4.50	3.38	2.70			

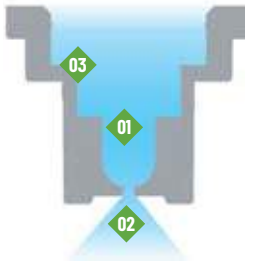

01. Non-Air Inducted; single inlet/outlet design
02. Fully formed spray pattern at low pressures
03. Enhanced polyacetal for superior product life

Droplet size based on ASABE S572.1 standard.

VARIABLE PRESSURE 80° & 110°

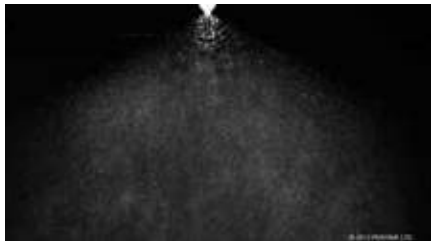

Low pressure performance allows for complete pattern formation and even coverage down to 15 psi (1 BAR).



Dense spray pattern of medium to fine droplets provides superior coverage.

METRIC UNITS

Nozzle Size	ASEBE Droplet Size		Pressure (BAR)	Flow Rate (LPM)	Application Rate L/Ha - 50 cm spacing							
	80°	110°			KM/H							
					7	8	10	15	20	25	30	
015	-	-	1	0,35	60	53	42	35	28	21	17	14
	-	-	1,5	0,42	72	63	50	42	34	25	20	17
	F	F	2	0,49	84	74	59	49	39	29	24	20
	F	F	3	0,60	103	90	72	60	48	36	29	24
	VF	VF	4	0,69	118	104	83	69	55	41	33	28
-	-	5	0,77	132	116	92	77	62	46	37	31	
02	-	-	1	0,46	79	69	55	46	37	28	22	18
	-	-	1,5	0,57	98	86	68	57	46	34	27	23
	F	F	2	0,65	111	98	78	65	52	39	31	26
	F	F	3	0,80	137	120	96	80	64	48	38	32
	F	F	4	0,92	158	138	110	92	74	55	44	37
-	-	5	1,03	177	155	124	103	82	62	49	41	
025	-	M	1	0,58	99	87	70	58	46	35	28	23
	-	M	1,5	0,71	122	107	85	71	57	43	34	28
	-	F	2	0,82	141	123	98	82	66	49	39	33
	-	F	3	1,00	171	150	120	100	80	60	48	40
	-	F	4	1,15	197	173	138	115	92	69	55	46
-	F	5	1,29	221	194	155	129	103	77	62	52	
03	C	M	1	0,69	118	104	83	69	55	41	33	28
	M	M	1,5	0,85	146	128	102	85	68	51	41	34
	M	F	2	0,98	168	147	118	98	78	59	47	39
	F	F	3	1,20	206	180	144	120	96	72	58	48
	F	F	4	1,39	238	209	167	139	111	83	67	56
-	F	5	1,55	266	233	186	155	124	93	74	62	
035	-	M	1	0,81	139	122	97	81	65	49	39	32
	-	M	1,5	0,99	170	149	119	99	79	59	48	40
	-	M	2	1,14	195	171	137	114	91	68	55	46
	-	F	3	1,40	240	210	168	140	112	84	67	56
	-	F	4	1,62	278	243	194	162	130	97	78	65
-	F	5	1,81	310	272	217	181	145	109	87	72	
04	C	M	1	0,92	158	138	110	92	74	55	44	37
	C	M	1,5	1,13	194	170	136	113	90	68	54	45
	M	M	2	1,31	225	197	157	131	105	79	63	52
	M	F	3	1,60	274	240	192	160	128	96	77	64
	F	F	4	1,85	317	278	222	185	148	111	89	74
-	F	5	2,07	355	311	248	207	166	124	99	83	
05	C	M	1	1,15	197	173	138	115	92	69	55	46
	C	M	1,5	1,41	242	212	169	141	113	85	68	56
	C	M	2	1,63	279	245	196	163	130	98	78	65
	M	F	3	2,00	343	300	240	200	160	120	96	80
	M	F	4	2,31	396	347	277	231	185	139	111	92
-	F	5	2,58	442	387	310	258	206	155	124	103	
06	C	C	1	1,39	238	209	167	139	111	83	67	56
	C	M	1,5	1,70	291	255	204	170	136	102	82	68
	C	M	2	1,96	336	294	235	196	157	118	94	78
	M	M	3	2,40	411	360	288	240	192	144	115	96
	M	F	4	2,77	475	416	332	277	222	166	133	111
-	F	5	3,10	531	465	372	310	248	186	149	124	
08	-	C	1	1,85	317	278	222	185	148	111	89	74
	-	C	1,5	2,26	387	339	271	226	181	136	108	90
	-	M	2	2,61	447	392	313	261	209	157	125	104
	-	M	3	3,20	549	480	384	320	256	192	154	128
	-	M	4	3,70	634	555	444	370	296	222	178	148
-	F	5	4,13	708	620	496	413	330	248	198	165	
10	-	C	1	2,31	396	347	277	231	185	139	111	92
	-	C	1,5	2,83	485	425	340	283	226	170	136	113
	-	M	2	3,27	561	491	392	327	262	196	157	131
	-	M	3	4,00	686	600	480	400	320	240	192	160
	-	M	4	4,62	792	693	554	462	370	277	222	185
-	F	5	5,16	885	774	619	516	413	310	248	206	
15	-	VC	1	3,46	593	519	415	346	277	208	166	138
	-	C	1,5	4,24	727	636	509	424	339	254	204	170
	-	C	2	4,90	840	735	588	490	392	294	235	196
	-	M	3	6,00	1029	900	720	600	480	360	288	240
	-	M	4	6,93	1188	1040	832	693	554	416	333	277
-	M	5	7,75	1329	1163	930	775	620	465	372	310	

Droplet size based on ASABE S572.1 standard.

Features	
Common Use	General
Pattern	Tapered Flat Fan
Technology	Elliptical Orifice
Material	Polyacetal
Spray Angle	80° & 110°
Pressure Range	20-70 PSI (1-5 BAR)
Configuration	Nozzles, FastCap
Optimum Boom Height	
80° - 15" (35 cm) Spacing	22' (56 cm)
80° - 20" (50 cm) Spacing	30' (76 cm)
110° - 15" (35 cm) Spacing	15' (35 cm)
110° - 20" (50 cm) Spacing	20' (50 cm)
Part Numbers (Bags of 10)	
Nozzles 80°	FastCaps 80°
VP80-015	FC-VP80-015
VP80-02	FC-VP80-02
VP80-03	FC-VP80-03
VP80-04	FC-VP80-04
VP80-05	FC-VP80-05
VP80-06	FC-VP80-06
Nozzles 110°	FastCaps 110°
VP110-015	FC-VP110-015
VP110-02	FC-VP110-02
VP110-025	FC-VP110-025
VP110-03*	FC-VP110-03
VP110-035	FC-VP110-035
VP110-04*	FC-VP110-04
VP110-05*	FC-VP110-05
VP110-06	FC-VP110-06
VP110-08	FC-VP110-08
VP110-10	FC-VP110-10
VP110-15	FC-VP110-15
Replacement Cap Gasket	
10BG-2270-0150	

*Approved by JKI

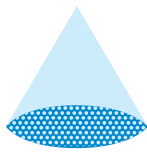

FANTIP 80° & 110°



The FanTip is a general spray nozzle that produces a mixed droplet spectrum over the 30-60 psi (2-4 bar) operational pressure range. It is good for broadcast applications.

- ◆ Economical option for general spraying
- ◆ Simple one-piece design
- ◆ Polyacetal construction for superior product life compared to stainless steel or brass

US UNITS

Nozzle Size	Droplet Size		Pressure (PSI)	Flow Rate (GPM)	Gallons per Acre 20 inch nozzle spacing										GAL/1000 Ft. ²				
	80°	110°			MPH										20 inch nozzle spacing				
					4	5	6	8	10	12	15	20	2	3	4	5			
0067	F	-	30	0.058	4.3	3.4	2.9	2.2	1.7	1.4	1.1	0.9	0.20	0.13	0.10	0.08			
	VF	-	40	0.067	5.0	4.0	3.3	2.5	2.0	1.7	1.3	1.0	0.23	0.15	0.11	0.09			
	VF	-	50	0.075	5.6	4.5	3.7	2.8	2.2	1.9	1.5	1.1	0.26	0.17	0.13	0.10			
	VF	-	60	0.082	6.1	4.9	4.1	3.0	2.4	2.0	1.6	1.2	0.28	0.19	0.14	0.11			
01	F	F	30	0.09	6.7	5.3	4.5	3.3	2.7	2.2	1.8	1.3	0.31	0.20	0.15	0.12			
	VF	F	40	0.10	7.4	5.9	5.0	3.7	3.0	2.5	2.0	1.5	0.34	0.23	0.17	0.14			
	VF	F	50	0.11	8.2	6.5	5.4	4.1	3.3	2.7	2.2	1.6	0.38	0.25	0.19	0.15			
	VF	VF	60	0.12	8.9	7.1	5.9	4.5	3.6	3.0	2.4	1.8	0.41	0.27	0.20	0.16			
015	F	F	30	0.13	9.7	7.7	6.4	4.8	3.9	3.2	2.6	1.9	0.44	0.30	0.22	0.18			
	F	F	40	0.15	11.1	8.9	7.4	5.6	4.5	3.7	3.0	2.2	0.51	0.34	0.26	0.20			
	F	F	50	0.17	12.6	10.1	8.4	6.3	5.0	4.2	3.4	2.5	0.58	0.39	0.29	0.23			
	VF	F	60	0.18	13.4	10.7	8.9	6.7	5.3	4.5	3.6	2.7	0.61	0.41	0.31	0.25			
02	M	F	30	0.17	12.6	10.1	8.4	6.3	5.0	4.2	3.4	2.5	0.58	0.39	0.29	0.23			
	F	F	40	0.20	14.9	11.9	9.9	7.4	5.9	5.0	4.0	3.0	0.68	0.45	0.34	0.27			
	F	F	50	0.22	16.3	13.1	10.9	8.2	6.5	5.4	4.4	3.3	0.75	0.50	0.38	0.30			
	F	F	60	0.24	17.8	14.3	11.9	8.9	7.1	5.9	4.8	3.6	0.82	0.55	0.41	0.33			
025	F	F	30	0.22	16.2	13.0	10.5	8.1	6.2	5.6	4.3	3.1	0.75	0.50	0.38	0.30			
	F	F	40	0.25	18.6	14.3	12.4	9.3	7.5	6.2	5.0	3.7	0.85	0.57	0.43	0.34			
	F	F	50	0.28	19.8	16.2	13.0	9.9	8.0	6.8	5.6	3.7	0.95	0.64	0.48	0.38			
	F	F	60	0.31	22.9	18.0	15.5	11.2	9.3	7.5	6.2	4.3	1.06	0.70	0.53	0.42			
03	C	F	30	0.26	19.3	15.4	12.9	9.7	7.7	6.4	5.1	3.9	0.89	0.59	0.44	0.35			
	M	F	40	0.30	22.3	17.8	14.9	11.1	8.9	7.4	5.9	4.5	1.02	0.68	0.51	0.41			
	M	F	50	0.34	25.2	20.2	16.8	12.6	10.1	8.4	6.7	5.0	1.16	0.77	0.58	0.46			
	F	F	60	0.37	27.5	22.0	18.3	13.7	11.0	9.2	7.3	5.5	1.26	0.84	0.63	0.50			
04	C	M	30	0.35	26.0	20.8	17.3	13.0	10.4	8.7	6.9	5.2	1.19	0.80	0.60	0.48			
	M	F	40	0.40	29.7	23.8	19.8	14.9	11.9	9.9	7.9	5.9	1.36	0.91	0.68	0.55			
	M	F	50	0.45	33.4	26.7	22.3	16.7	13.4	11.1	8.9	6.7	1.53	1.02	0.77	0.61			
	M	F	60	0.49	36.4	29.1	24.3	18.2	14.6	12.1	9.7	7.3	1.67	1.11	0.84	0.67			
05	C	M	30	0.43	31.9	25.5	21.3	16.0	12.8	10.6	8.5	6.4	1.47	0.98	0.73	0.59			
	M	F	40	0.50	37.1	29.7	24.8	18.6	14.9	12.4	9.9	7.4	1.71	1.14	0.85	0.68			
	M	F	50	0.56	41.6	33.3	27.7	20.8	16.6	13.9	11.1	8.3	1.91	1.27	0.95	0.76			
	M	F	60	0.61	45.3	36.2	30.2	22.6	18.1	15.1	12.1	9.1	2.08	1.39	1.04	0.83			
06	C	M	30	0.52	38.6	30.9	25.7	19.3	15.4	12.9	10.3	7.7	1.77	1.18	0.89	0.71			
	C	M	40	0.60	44.6	35.6	29.7	22.3	17.8	14.9	11.9	8.9	2.05	1.36	1.02	0.82			
	C	F	50	0.67	49.7	39.8	33.2	24.9	19.9	16.6	13.3	9.9	2.28	1.52	1.14	0.91			
	C	F	60	0.73	54.2	43.4	36.1	27.1	21.7	18.1	14.5	10.8	2.49	1.66	1.24	1.00			
08	VC	M	30	0.69	51.2	41.0	34.2	25.6	20.5	17.1	13.7	10.2	2.35	1.57	1.18	0.94			
	C	M	40	0.80	59.4	47.5	39.6	29.7	23.8	19.8	15.8	11.9	2.73	1.82	1.36	1.09			
	C	M	50	0.89	66.1	52.9	44.1	33.0	26.4	22.0	17.6	13.2	3.03	2.02	1.52	1.21			
	C	M	60	0.98	72.8	58.2	48.5	36.4	29.1	24.3	19.4	14.6	3.34	2.23	1.67	1.34			
10	VC	C	30	0.87	64.6	51.7	43.1	32.3	25.8	21.5	17.2	12.9	2.97	1.98	1.48	1.19			
	C	C	40	1.00	74.3	59.4	49.5	37.1	29.7	24.8	19.8	14.9	3.41	2.27	1.71	1.36			
	C	C	50	1.12	83.2	66.5	55.4	41.6	33.3	27.7	22.2	16.6	3.82	2.55	1.91	1.53			
	C	C	60	1.22	90.6	72.5	60.4	45.3	36.2	30.2	24.2	18.1	4.16	2.77	2.08	1.66			
15	VC	C	30	1.30	96.5	77.2	64.4	48.3	38.6	32.2	25.7	19.3	4.43	2.96	2.22	1.77			
	VC	C	40	1.50	111	89.1	74.3	55.7	44.6	37.1	29.7	22.3	5.12	3.41	2.56	2.05			
	C	C	50	1.68	125	99.8	83.2	62.4	49.9	41.6	33.3	24.9	5.73	3.82	2.86	2.29			
	C	C	60	1.84	137	109	91.1	68.3	54.6	45.5	36.4	27.3	6.27	4.18	3.14	2.51			
20	VC	C	30	1.73	128	103	85.6	64.2	51.4	42.8	34.3	25.7	5.90	3.93	2.95	2.36			
	VC	C	40	2.00	149	119	99.0	74.3	59.4	49.5	39.6	29.7	6.82	4.55	3.41	2.73			
	VC	C	50	2.24	166	133	111	83.2	66.5	55.4	44.4	33.3	7.64	5.09	3.82	3.06			
	VC	C	60	2.45	182	146	121	91.0	72.8	60.6	48.5	36.4	8.35	5.57	4.18	3.34			

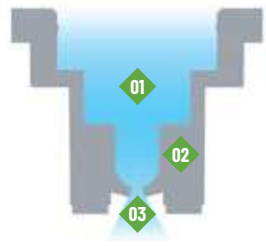

01. Simple; Non-Air Inducted technology
02. Polyacetal; single piece design
03. Available in many sizes to meet your flow rate needs

Droplet size based on ASABE S572.1 standard.

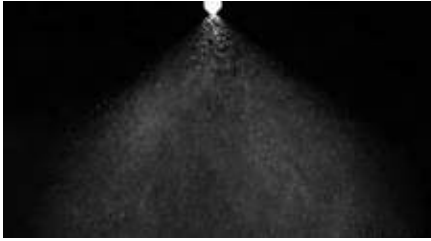

80° or 110° wide spray patterns; broad flow range and droplet spectrum to fit many spraying applications.

Polyacetal construction provides a wear resistant orifice to ensure pattern integrity.

METRIC UNITS

Nozzle Size	ASABE Droplet Size		Pressure (BAR)	Flow Rate (LPM)	Application Rate L/Ha- 50 cm Spacing							
	80°	110°			KM/H							
					7	8	10	12	15	20	25	30
0067	F	-	2	0,22	38	33	26	22	18	13	11	9
	VF	-	2,5	0,25	43	38	30	25	20	15	12	10
	VF	-	3	0,27	46	41	32	27	22	16	13	11
	VF	-	4	0,31	53	47	37	31	25	19	15	12
01	VF	F	2	0,33	57	50	40	33	26	20	16	13
	VF	F	2,5	0,37	63	56	44	37	30	22	18	15
	VF	F	3	0,40	69	60	48	40	32	24	19	16
	VF	VF	4	0,46	79	69	55	46	37	28	22	18
015	F	F	2	0,49	84	74	59	49	39	29	24	20
	F	F	2,5	0,55	94	83	66	55	44	33	26	22
	F	F	3	0,60	103	90	72	60	48	36	29	24
	VF	F	4	0,69	118	104	83	69	55	41	33	28
02	M	F	2	0,65	111	98	78	65	52	39	31	26
	F	F	2,5	0,73	125	110	88	73	58	44	35	29
	F	F	3	0,80	137	120	96	80	64	48	38	32
	F	F	4	0,92	158	138	110	92	74	55	44	37
025	F	F	2	0,82	140	122	98	82	65	49	39	33
	F	F	2,5	0,91	156	137	110	91	73	55	44	37
	F	F	3	1,00	171	150	120	100	80	60	48	40
	F	F	4	1,16	198	173	139	115	92	69	55	46
03	C	F	2	0,98	168	147	118	98	78	59	47	39
	M	F	2,5	1,10	189	165	132	110	88	66	53	44
	M	F	3	1,20	206	180	144	120	96	72	58	48
	F	F	4	1,39	238	209	167	139	111	83	67	56
04	C	M	2	1,31	225	197	157	131	105	79	63	52
	M	F	2,5	1,46	250	219	175	146	117	88	70	58
	M	F	3	1,60	274	240	192	160	128	96	77	64
	M	F	4	1,85	317	278	222	185	148	111	89	74
05	C	M	2	1,63	279	245	196	163	130	98	78	65
	M	M	2,5	1,83	314	275	220	183	146	110	88	73
	M	F	3	2,00	343	300	240	200	160	120	96	80
	M	F	4	2,31	396	347	277	231	185	139	111	92
06	C	M	2	1,96	336	294	235	196	157	118	94	78
	C	M	2,5	2,19	375	329	263	219	175	131	105	88
	C	M	3	2,40	411	360	288	240	192	144	115	96
	C	F	4	2,77	475	416	332	277	222	166	133	111
08	VC	M	2	2,61	447	392	313	261	209	157	125	104
	C	M	2,5	2,92	501	438	350	292	234	175	140	117
	C	M	3	3,20	549	480	384	320	256	192	154	128
	C	M	4	3,70	634	555	444	370	296	222	178	148
10	VC	C	2	3,27	561	491	392	327	262	196	157	131
	C	C	2,5	3,65	626	548	438	365	292	219	175	146
	C	C	3	4,00	686	600	480	400	320	240	192	160
	C	C	4	4,62	792	693	554	462	370	277	222	185
15	VC	C	2	4,90	840	735	588	490	392	294	235	196
	VC	C	2,5	5,48	939	822	658	548	438	329	263	219
	VC	C	3	6,00	1029	900	720	600	480	360	288	240
	C	C	4	6,93	1188	1040	832	693	554	416	333	277
20	VC	C	2	6,53	1119	980	784	653	522	392	313	261
	VC	C	2,5	7,30	1251	1095	876	730	584	438	350	292
	VC	C	3	8,00	1371	1200	960	800	640	480	384	320
	VC	C	4	9,24	1584	1386	1109	924	739	554	444	370

Droplet size based on ASABE S572.1 standard.

Features		
Common Use	General	
Pattern	Tapered Flat Fan	
Technology	Elliptical Orifice	
Material	Polyacetal	
Spray Angle	80° & 110°	
Pressure Range	30-60 PSI (2-4 BAR)	
Configuration	Nozzle	
Optimum Boom Height		
80° - 15° (35 cm) Spacing	22' (56 cm)	
80° - 20° (50 cm) Spacing	30' (76 cm)	
110° - 15° (35 cm) Spacing	15' (35 cm)	
110° - 20° (50 cm) Spacing	20' (50 cm)	
Part Numbers (Bags of 10)		
Nozzles 80°	Nozzles 110°	Caps (25 Pack)
F80-0067	-	CAP00-20
F80-01	F110-01	CAP00-01
F80-015	F110-015	CAP00-015
F80-02	F110-02	CAP00-02
F80-03	F110-03	CAP00-03
F80-04	F110-04	CAP00-04
F80-05	F110-05	CAP00-05
F80-06	F110-06	CAP00-06
F80-08	F110-08	CAP00-08
F80-10	F110-10	CAP00-10
F80-15	F110-15	CAP00-15
F80-20	F110-20	CAP00-20

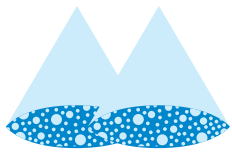

CERAMIC AVI TWIN 110°



The Albus® AVI Twin (ATW) brings drift control and coverage together. Using proven AVI technology, the AVI Twin draws air into the nozzle, mixing it with the spray to create a twin spray of drift resistant air-filled droplets. Drift is greatly reduced, spraying the canopy with dual trajectories to improve coverage.

- ◆ Coverage-enhancing twin patterns from a single nozzle
- ◆ Drift-reducing AVI venturi technology
- ◆ 60-degrees of separation between fans
- ◆ Pressures from 40 to 100 psi (3-7 bar)
- ◆ Wear-resistant Albus ceramic orifices

US UNITS

Nozzle Size	Droplet Size	Pressure (PSI)	Flow Rate (GPM)	Gallons per Acre 20 inch nozzle spacing								GAL/1000 Ft ²			
				MPH								20 inch nozzle spacing			
				4	5	6	8	10	12	15	20	2	3	4	5
01	XC	40	0.10	7.4	5.9	5.0	3.7	3.0	2.5	2.0	1.5	0.34	0.23	0.17	0.14
	XC	50	0.11	8.2	6.5	5.4	4.1	3.3	2.7	2.2	1.6	0.38	0.25	0.19	0.15
	XC	60	0.12	8.9	7.1	5.9	4.5	3.6	3.0	2.4	1.8	0.41	0.27	0.20	0.16
	C	70	0.13	9.7	7.7	6.4	4.8	3.9	3.2	2.6	1.9	0.44	0.30	0.22	0.18
	C	80	0.14	10.4	8.3	6.9	5.2	4.2	3.5	2.8	2.1	0.48	0.32	0.24	0.19
	C	90	0.15	11.1	8.9	7.4	5.6	4.5	3.7	3.0	2.2	0.51	0.34	0.26	0.20
015	C	100	0.16	11.9	9.5	7.9	5.9	4.8	4.0	3.2	2.4	0.55	0.36	0.27	0.22
	XC	40	0.15	11.1	8.9	7.4	5.6	4.5	3.7	3.0	2.2	0.51	0.34	0.26	0.20
	XC	50	0.17	12.6	10.1	8.4	6.3	5.0	4.2	3.4	2.5	0.58	0.39	0.29	0.23
	XC	60	0.18	13.4	10.7	8.9	6.7	5.3	4.5	3.6	2.7	0.61	0.41	0.31	0.25
	C	70	0.20	14.9	11.9	9.9	7.4	5.9	5.0	4.0	3.0	0.68	0.45	0.34	0.27
	C	80	0.21	15.6	12.5	10.4	7.8	6.2	5.2	4.2	3.1	0.72	0.48	0.36	0.29
02	C	90	0.23	17.1	13.7	11.4	8.5	6.8	5.7	4.6	3.4	0.78	0.52	0.39	0.31
	C	100	0.24	17.8	14.3	11.9	8.9	7.1	5.9	4.8	3.6	0.82	0.55	0.41	0.33
	XC	40	0.20	14.9	11.9	9.9	7.4	5.9	5.0	4.0	3.0	0.68	0.45	0.34	0.27
	XC	50	0.22	16.3	13.1	10.9	8.2	6.5	5.4	4.4	3.3	0.75	0.50	0.38	0.30
	XC	60	0.24	17.8	14.3	11.9	8.9	7.1	5.9	4.8	3.6	0.82	0.55	0.41	0.33
	C	70	0.26	19.3	15.4	12.9	9.7	7.7	6.4	5.1	3.9	0.89	0.59	0.44	0.35
03	C	80	0.28	20.8	16.6	13.9	10.4	8.3	6.9	5.5	4.2	0.95	0.64	0.48	0.38
	C	90	0.30	22.3	17.8	14.9	11.1	8.9	7.4	5.9	4.5	1.02	0.68	0.51	0.41
	C	100	0.32	23.8	19.0	15.8	11.9	9.5	7.9	6.3	4.8	1.09	0.73	0.55	0.44
	XC	40	0.30	22.3	17.8	14.9	11.1	8.9	7.4	5.9	4.5	1.02	0.68	0.51	0.41
	XC	50	0.34	25.2	20.2	16.8	12.6	10.1	8.4	6.7	5.0	1.16	0.77	0.58	0.46
	XC	60	0.37	27.5	22.0	18.3	13.7	11.0	9.2	7.3	5.5	1.26	0.84	0.63	0.50
04	VC	70	0.40	29.7	23.8	19.8	14.9	11.9	9.9	7.9	5.9	1.36	0.91	0.68	0.55
	VC	80	0.42	31.2	24.9	20.8	15.6	12.5	10.4	8.3	6.2	1.43	0.95	0.72	0.57
	C	90	0.45	33.4	26.7	22.3	16.7	13.4	11.1	8.9	6.7	1.53	1.02	0.77	0.61
	C	100	0.47	34.9	27.9	23.3	17.4	14.0	11.6	9.3	7.0	1.60	1.07	0.80	0.64
	XC	40	0.40	29.7	23.8	19.8	14.9	11.9	9.9	7.9	5.9	1.36	0.91	0.68	0.55
	XC	50	0.45	33.4	26.7	22.3	16.7	13.4	11.1	8.9	6.7	1.53	1.02	0.77	0.61
05	XC	60	0.49	36.4	29.1	24.3	18.2	14.6	12.1	9.7	7.3	1.67	1.11	0.84	0.67
	VC	70	0.53	39.4	31.5	26.2	19.7	15.7	13.1	10.5	7.9	1.81	1.20	0.90	0.72
	VC	80	0.57	42.3	33.9	28.2	21.2	16.9	14.1	11.3	8.5	1.94	1.30	0.97	0.78
	C	90	0.60	44.6	35.6	29.7	22.3	17.8	14.9	11.9	8.9	2.05	1.36	1.02	0.82
	C	100	0.63	46.8	37.4	31.2	23.4	18.7	15.6	12.5	9.4	2.15	1.43	1.07	0.86
	XC	40	0.50	37.1	29.7	24.8	18.6	14.9	12.4	9.9	7.4	1.71	1.14	0.85	0.68
XC	50	0.56	41.6	33.3	27.7	20.8	16.6	13.9	11.1	8.3	1.91	1.27	0.95	0.76	
XC	60	0.61	45.3	36.2	30.2	22.6	18.1	15.1	12.1	9.1	2.08	1.39	1.04	0.83	
VC	70	0.66	49.0	39.2	32.7	24.5	19.6	16.3	13.1	9.8	2.25	1.50	1.13	0.90	
VC	80	0.71	52.7	42.2	35.1	26.4	21.1	17.6	14.1	10.5	2.42	1.61	1.21	0.97	
C	90	0.75	55.7	44.6	37.1	27.8	22.3	18.6	14.9	11.1	2.56	1.71	1.28	1.02	
C	100	0.79	58.7	46.9	39.1	29.3	23.5	19.6	15.6	11.7	2.69	1.80	1.35	1.08	

Droplet size based on ASABE S572.1 standard.



METRIC UNITS

Nozzle Size	Droplet Size 110°	Pressure (bar)	Flow (L/min)	Application Rate L/Ha- 50 cm Spacing									
				KM/H									
				6	8	10	12	14	16	18	20	25	30
01	XC	3	0.40	105	79	63	53	45	39	35	32	25	21
	XC	4	0.46	121	91	73	61	52	45	40	36	29	24
	C	5	0.52	137	103	82	68	59	51	46	41	33	27
	C	6	0.57	150	113	90	75	64	56	50	45	36	30
015	XC	3	0.60	158	118	95	79	68	59	53	47	38	32
	XC	4	0.69	182	136	109	91	78	68	61	54	44	36
	C	5	0.77	203	152	122	101	87	76	68	61	49	41
	C	6	0.85	224	168	134	112	96	84	75	67	54	45
02	XC	3	0.80	211	158	126	105	90	79	70	63	51	42
	XC	4	0.92	242	182	145	121	104	91	81	73	58	48
	C	5	1.03	271	203	163	136	116	102	90	81	65	54
	C	6	1.13	297	223	178	149	127	112	99	89	71	59
03	XC	3	1.20	316	237	189	158	135	118	105	95	76	63
	XC	4	1.39	366	274	219	183	157	137	122	110	88	73
	VC	5	1.55	408	306	245	204	175	153	136	122	98	82
	C	6	1.70	447	336	268	224	192	168	149	134	107	89
04	XC	3	1.60	421	316	253	211	180	158	140	126	101	84
	XC	4	1.85	487	365	292	243	209	183	162	146	117	97
	VC	5	2.07	545	409	327	272	233	204	182	163	131	109
	C	6	2.26	595	446	357	297	255	223	198	178	143	119
05	XC	3	2.00	526	395	316	263	226	197	175	158	126	105
	XC	4	2.31	608	456	365	304	261	228	203	182	146	122
	VC	5	2.58	679	509	407	339	291	255	226	204	163	136
	C	6	2.83	745	559	447	372	319	279	248	223	179	149

Droplet size based on ASABE S572.1 standard.

Features	
Common Use	Plant Health
Pattern	Tapered Flat Fan
Technology	Air Induction
Material	Ceramic
Spray Angle	110°
Pressure Range	40-100 PSI (3-7 BAR)
Configuration	Nozzles
Optimum Boom Height	
110° - 15° (35 cm) Spacing	15' (35 cm)
110° - 20° (50 cm) Spacing	20' (50 cm)
Part Numbers	
Nozzles 110°	Caps (25 Pack)
ATW-11001	CAP01-01
ATW-110015	CAP01-015
ATW-11002	CAP01-02
ATW-11003	CAP01-03
ATW-11004	CAP01-04
ATW-11005	CAP01-05

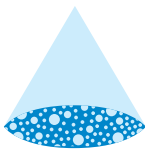

CERAMIC AVI 110°

The Albuz® AVI draws air into the nozzle and mixes it with the spray to create very coarse droplets that minimize spray drift. The air-filled droplets have a larger footprint on the leaf than similar non-air droplets and hold to the leaf for better control. Durable Albuz ceramic orifice create the longest wearing spray nozzle of its kind.



- ◆ Excellent drift reduction with large air-filled droplets
- ◆ Large passages resist plugging
- ◆ Wear-resistant Albuz ceramic orifice
- ◆ 80° fan models ideal for use in directed spray applications (See page 177 for more information)
- ◆ FastCap includes nozzle, cap and gasket

US UNITS

Nozzle Size	Droplet Size 110°	Pressure (PSI)	Flow Rate (GPM)	Gallons per Acre 20 inch nozzle spacing							GAL/1000 ft² 20 inch nozzle spacing				
				MPH											
				4	5	6	8	10	12	15	20	2	3	4	5
01	VC	30	0.09	6.7	5.3	4.5	3.3	2.7	2.2	1.8	1.3	0.31	0.20	0.15	0.12
	VC	40	0.10	7.4	5.9	5.0	3.7	3.0	2.5	2.0	1.5	0.34	0.23	0.17	0.14
	VC	50	0.11	8.2	6.5	5.4	4.1	3.3	2.7	2.2	1.6	0.38	0.25	0.19	0.15
	C	60	0.12	8.9	7.1	5.9	4.5	3.6	3.0	2.4	1.8	0.41	0.27	0.20	0.16
	C	70	0.13	9.7	7.7	6.4	4.8	3.9	3.2	2.6	1.9	0.44	0.30	0.22	0.18
	C	80	0.14	10.4	8.3	6.9	5.2	4.2	3.5	2.8	2.1	0.48	0.32	0.24	0.19
	C	90	0.15	11.1	8.9	7.4	5.6	4.5	3.7	3.0	2.2	0.51	0.34	0.26	0.20
C	100	0.16	11.9	9.5	7.9	5.9	4.8	4.0	3.2	2.4	0.55	0.36	0.27	0.22	
015	VC	30	0.13	9.7	7.7	6.4	4.8	3.9	3.2	2.6	1.9	0.44	0.30	0.22	0.18
	VC	40	0.15	11.1	8.9	7.4	5.6	4.5	3.7	3.0	2.2	0.51	0.34	0.26	0.20
	VC	50	0.17	12.6	10.1	8.4	6.3	5.0	4.2	3.4	2.5	0.58	0.39	0.29	0.23
	C	60	0.18	13.4	10.7	8.9	6.7	5.3	4.5	3.6	2.7	0.61	0.41	0.31	0.25
	C	70	0.20	14.9	11.9	9.9	7.4	5.9	5.0	4.0	3.0	0.68	0.45	0.34	0.27
	C	80	0.21	15.6	12.5	10.4	7.8	6.2	5.2	4.2	3.1	0.72	0.48	0.36	0.29
	C	90	0.23	17.1	13.7	11.4	8.5	6.8	5.7	4.6	3.4	0.78	0.52	0.39	0.31
C	100	0.24	17.8	14.3	11.9	8.9	7.1	5.9	4.8	3.6	0.82	0.55	0.41	0.33	
02	VC	30	0.17	12.6	10.1	8.4	6.3	5.0	4.2	3.4	2.5	0.58	0.39	0.29	0.23
	VC	40	0.20	14.9	11.9	9.9	7.4	5.9	5.0	4.0	3.0	0.68	0.45	0.34	0.27
	VC	50	0.22	16.3	13.1	10.9	8.2	6.5	5.4	4.4	3.3	0.75	0.50	0.38	0.30
	C	60	0.24	17.8	14.3	11.9	8.9	7.1	5.9	4.8	3.6	0.82	0.55	0.41	0.33
	C	70	0.26	19.3	15.4	12.9	9.7	7.7	6.4	5.1	3.9	0.89	0.59	0.44	0.35
	C	80	0.28	20.8	16.6	13.9	10.4	8.3	6.9	5.5	4.2	0.95	0.64	0.48	0.38
	C	90	0.30	22.3	17.8	14.9	11.1	8.9	7.4	5.9	4.5	1.02	0.68	0.51	0.41
C	100	0.32	23.8	19.0	15.8	11.9	9.5	7.9	6.3	4.8	1.09	0.73	0.55	0.44	
025	XC	30	0.22	16.3	13.1	10.9	8.2	6.5	5.4	4.4	3.3	0.75	0.50	0.38	0.30
	VC	40	0.25	18.6	14.9	12.4	9.3	7.4	6.2	5.0	3.7	0.85	0.57	0.43	0.34
	VC	50	0.28	20.8	16.6	13.9	10.4	8.3	6.9	5.5	4.2	0.95	0.64	0.48	0.38
	C	60	0.31	23.0	18.4	15.3	11.5	9.2	7.7	6.1	4.6	1.06	0.70	0.53	0.42
	C	70	0.33	24.5	19.6	16.3	12.3	9.8	8.2	6.5	4.9	1.13	0.75	0.56	0.45
	C	80	0.35	26.0	20.8	17.3	13.0	10.4	8.7	6.9	5.2	1.19	0.80	0.60	0.48
	C	90	0.38	28.2	22.6	18.8	14.1	11.3	9.4	7.5	5.6	1.30	0.86	0.65	0.52
C	100	0.40	29.7	23.8	19.8	14.9	11.9	9.9	7.9	5.9	1.36	0.91	0.68	0.55	
03	XC	30	0.26	19.3	15.4	12.9	9.7	7.7	6.4	5.1	3.9	0.89	0.59	0.44	0.35
	XC	40	0.30	22.3	17.8	14.9	11.1	8.9	7.4	5.9	4.5	1.02	0.68	0.51	0.41
	VC	50	0.34	25.2	20.2	16.8	12.6	10.1	8.4	6.7	5.0	1.16	0.77	0.58	0.46
	C	60	0.37	27.5	22.0	18.3	13.7	11.0	9.2	7.3	5.5	1.26	0.84	0.63	0.50
	C	70	0.40	29.7	23.8	19.8	14.9	11.9	9.9	7.9	5.9	1.36	0.91	0.68	0.55
	C	80	0.42	31.2	24.9	20.8	15.6	12.5	10.4	8.3	6.2	1.43	0.95	0.72	0.57
	C	90	0.45	33.4	26.7	22.3	16.7	13.4	11.1	8.9	6.7	1.53	1.02	0.77	0.61
C	100	0.47	34.9	27.9	23.3	17.4	14.0	11.6	9.3	7.0	1.60	1.07	0.80	0.64	
04	XC	30	0.35	26.0	20.8	17.3	13.0	10.4	8.7	6.9	5.2	1.19	0.80	0.60	0.48
	XC	40	0.40	29.7	23.8	19.8	14.9	11.9	9.9	7.9	5.9	1.36	0.91	0.68	0.55
	XC	50	0.45	33.4	26.7	22.3	16.7	13.4	11.1	8.9	6.7	1.53	1.02	0.77	0.61
	VC	60	0.49	36.4	29.1	24.3	18.2	14.6	12.1	9.7	7.3	1.67	1.11	0.84	0.67
	VC	70	0.53	39.4	31.5	26.2	19.7	15.7	13.1	10.5	7.9	1.81	1.20	0.90	0.72
	VC	80	0.57	42.3	33.9	28.2	21.2	16.9	14.1	11.3	8.5	1.94	1.30	0.97	0.78
	VC	90	0.60	44.6	35.6	29.7	22.3	17.8	14.9	11.9	8.9	2.05	1.36	1.02	0.82
VC	100	0.63	46.8	37.4	31.2	23.4	18.7	15.6	12.5	9.4	2.15	1.43	1.07	0.86	
05	XC	30	0.43	31.9	25.5	21.3	16.0	12.8	10.6	8.5	6.4	1.47	0.98	0.73	0.59
	XC	40	0.50	37.1	29.7	24.8	18.6	14.9	12.4	9.9	7.4	1.71	1.14	0.85	0.68
	XC	50	0.56	41.6	33.3	27.7	20.8	16.6	13.9	11.1	8.3	1.91	1.27	0.95	0.76
	XC	60	0.61	45.3	36.2	30.2	22.6	18.1	15.1	12.1	9.1	2.08	1.39	1.04	0.83
	VC	70	0.66	49.0	39.2	32.7	24.5	19.6	16.3	13.1	9.8	2.25	1.50	1.13	0.90
	VC	80	0.71	52.7	42.2	35.1	26.4	21.1	17.6	14.1	10.5	2.42	1.61	1.21	0.97
	VC	90	0.75	55.7	44.6	37.1	27.8	22.3	18.6	14.9	11.1	2.56	1.71	1.28	1.02
VC	100	0.79	58.7	46.9	39.1	29.3	23.5	19.6	15.6	11.7	2.69	1.80	1.35	1.08	
06	XC	30	0.52	38.6	30.9	25.7	19.3	15.4	12.9	10.3	7.7	1.77	1.18	0.89	0.71
	XC	40	0.60	44.6	35.6	29.7	22.3	17.8	14.9	11.9	8.9	2.05	1.36	1.02	0.82
	XC	50	0.67	49.7	39.8	33.2	24.9	19.9	16.6	13.3	9.9	2.28	1.52	1.14	0.91
	XC	60	0.73	54.2	43.4	36.1	27.1	21.7	18.1	14.5	10.8	2.49	1.66	1.24	1.00
	VC	70	0.79	58.7	46.9	39.1	29.3	23.5	19.6	15.6	11.7	2.69	1.80	1.35	1.08
	VC	80	0.85	63.1	50.5	42.1	31.6	25.2	21.0	16.8	12.6	2.90	1.93	1.45	1.16
	VC	90	0.90	66.8	53.5	44.6	33.4	26.7	22.3	17.8	13.4	3.07	2.05	1.53	1.23
VC	100	0.95	70.5	56.4	47.0	35.3	28.2	23.5	18.8	14.1	3.24	2.16	1.62	1.30	
08	XC	30	0.69	51.2	41.0	34.2	25.6	20.5	17.1	13.7	10.2	2.35	1.57	1.18	0.94
	XC	40	0.80	59.4	47.5	39.6	29.7	23.8	19.8	15.8	11.9	2.73	1.82	1.36	1.09
	XC	50	0.89	66.1	52.9	44.1	33.0	26.4	22.0	17.6	13.2	3.03	2.02	1.52	1.21
	XC	60	0.98	72.8	58.2	48.5	36.4	29.1	24.3	19.4	14.6	3.34	2.23	1.67	1.34
	XC	70	1.06	78.7	63.0	52.5	39.4	31.5	26.2	21.0	15.7	3.61	2.41	1.81	1.45
	XC	80	1.13	83.9	67.1	55.9	42.0	33.6	28.0	22.4	16.8	3.85	2.57	1.93	1.54
	XC	90	1.20	89.1	71.3	59.4	44.6	35.6	29.7	23.8	17.8	4.09	2.73	2.05	1.64
XC	100	1.26	93.6	74.8	62.4	46.8	37.4	31.2	24.9	18.7	4.30	2.86	2.15	1.72	
10	XC	30	0.87	64.6	51.7	43.1	32.3	25.8	21.5	17.2	12.9	2.97	1.98	1.48	1.19
	XC	40	1.00	74.3	59.4	49.5	37.1	29.7	24.8	19.8	14.9	3.41	2.27	1.71	1.36
	XC	50	1.12	83.2	66.5	55.4	41.6	33.3	27.7	22.2	16.6	3.82	2.55	1.91	1.53
	XC	60	1.22	90.6	72.5	60.4	45.3	36.2	30.2	24.2	18.1	4.16	2.77	2.08	1.66
	XC	70	1.32	98.0	78.4	65.3	49.0	39.2	32.7	26.1	19.6	4.50	3.00	2.25	1.80
	XC	80	1.41	105	83.8	69.8	52.3	41.9	34.9	27.9	20.9	4.81	3.21	2.40	1.92
	XC	90	1.50	111	89.1	74.3	55.7	44.6	37.1	29.7	22.3	5.12	3.41	2.56	2.05
XC	100	1.58	117	93.9	78.2	58.7	46.9	39.1	31.3	23.5	5.39	3.59	2.69	2.16	

Hypro is a registered trademark of Pentair.
Droplet size based on ASABE S572.1 standard.



METRIC UNITS

Nozzle Size	Droplet Size 110°	Pressure (bar)	Flow (L/min)	Application Rate L/Ha- 50 cm Spacing									
				KM/H									
				6	8	10	12	14	16	18	20	25	30
01	VC	2	0.33	87	65	52	43	37	33	29	26	21	17
	VC	3	0.40	105	79	63	53	45	39	35	32	25	21
	VC	4	0.46	121	91	73	61	52	45	40	36	29	24
	C	5	0.52	137	103	82	68	59	51	46	41	33	27
	C	6	0.57	150	113	90	75	64	56	50	45	36	30
	C	7	0.61	161	120	96	80	69	60	54	48	39	32
	VC	2	0.49	129	97	77	64	55	48	43	39	31	26
015	VC	3	0.60	158	118	95	79	68	59	53	47	38	32
	VC	4	0.69	182	136	109	91	78	68	61	54	44	36
	VC	5	0.77	203	152	122	101	87	76	68	61	49	41
	C	6	0.85	224	168	134	112	96	84	75	67	54	45
	C	7	0.92	242	182	145	121	104	91	81	73	58	48
	VC	2	0.65	171	128	103	86	73	64	57	51	41	34
	02	VC	3	0.80	211	158	126	105	90	79	70	63	51
VC		4	0.92	242	182	145	121	104	91	81	73	58	48
VC		5	1.03	271	203	163	136	116	102	90	81	65	54
VC		6	1.13	297	223	178	149	127	112	99	89	71	59
C		7	1.22	321	241	193	161	138	120	107	96	77	64
XC		2	0.82	216	162	129	108	92	81	72	65	52	43
025		VC	3	1.00	263	197	158	132	113	99	88	79	63
	VC	4	1.15	303	227	182	151	130	113	101	91	73	61
	VC	5	1.29	339	255	204	170	145	127	113	102	81	68
	VC	6	1.41	371	278	223	186	159	139	124	111	89	74
	VC	7	1.53	403	302	242	201	173	151	134	121	97	81
	XC	2	0.98	258	193	155	129	111	97	86	77	62	52
	03	XC	3	1.20	316	237	189	158	135	118	105	95	76
VC		4	1.39	366	274	219	183	157	137	122	110	88	73
VC		5	1.55	408	306	245	204	175	153	136	122	98	82
VC		6	1.70	447	336	268	224	192	168	149	134	107	89
VC		7	1.83	482	361	289	241	206	181	161	144	116	96
XC		2	1.31	345	259	207	172	148	129	115	103	83	69
04		XC	3	1.60	421	316	253	211	180	158	140	126	101
	VC	4	1.85	487	365	292	243	209	183	162	146	117	97
	VC	5	2.07	545	409	327	272	233	204	182	163	131	109
	VC	6	2.26	595	446	357	297	255	223	198	178	143	119
	VC	7	2.44	642	482	385	321	275	241	214	193	154	128
	XC	2	1.63	429	322	257	214	184	161	143	129	103	86
	05	XC	3	2.00	526	395	316	263	226	197	175	158	126
VC		4	2.31	608	456	365	304	261	228	203	182	146	122
VC		5	2.58	679	509	407	339	291	255	226	204	163	136
VC		6	2.83	745	559	447	372	319	279	248	223	179	149
VC		7	3.06	805	604	483	403	345	302	268	242	193	161
XC		2	1.96	516	387	309	258	221	193	172	155	124	103
06		XC	3	2.40	632	474	379	316	271	237	211	189	152
	VC	4	2.77	729	547	437	364	312	273	243	219	175	146
	VC	5	3.10	816	612	489	408	350	306	272	245	196	163
	VC	6	3.39	892	669	535	446	382	335	297	268	214	178
	VC	7	3.67	966	724	579	483	414	362	322	290	232	193
	XC	2	2.61	687	515	412	343	294	258	229	206	165	137
	08	XC	3	3.20	842	632	505	421	361	316	281	253	202
XC		4	3.70	974	730	584	487	417	365	325	292	234	195
XC		5	4.13	1087	815	652	543	466	408	362	326	261	217
XC		6	4.53	1192	894	715	596	511	447	397	358	286	238
XC		7	4.89	1287	965	772	643	552	483	429	386	309	257
XC		2	3.27	861	645	516	430	369	323	287	258	207	172
10		XC	3	4.00	1053	789	632	526	451	395	351	316	253
	XC	4	4.62	1216	912	729	608	521	456	405	365	292	243
	XC	5	5.16	1358	1018	815	679	582	509	453	407	326	272
	XC	6	5.66	1489	1117	894	745	638	559	496	447	357	298
	XC	7	6.11	1608	1206	965	804	689	603	536	482	386	322

Droplet size based on ASABE S572.1 standard.

Features	
Common Use	Weeds
Pattern	Tapered Flat Fan
Technology	Air Induction
Material	Ceramic
Spray Angle	110°
Pressure Range	30-100 PSI (2-7 BAR)
Configuration	Nozzles, FastCap Complete
Optimum Boom Height	
110° - 15" (35 cm) Spacing	15" (35 cm)
110° - 20" (50 cm) Spacing	20" (50 cm)
Nozzles	FastCaps
AVI-11001	FC-AVI-11001
AVI-110015	FC-AVI-110015
AVI-11002	FC-AVI-11002
AVI-110025	FC-AVI-110025
AVI-11003	FC-AVI-11003
AVI-11004	FC-AVI-11004
AVI-11005	FC-AVI-11005
AVI-11006	FC-AVI-11006
AVI-11008	FC-AVI-11008
AVI-11010	FC-AVI-11010
Replacement Cap Gasket	
10BG-2270-0150	

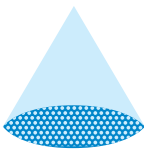

CERAMIC ADI 110°



The Albuz® ADI anti-drift spray nozzle provides a versatile balance of drift reduction and target coverage. The proven pre-orifice design creates droplets that are well suited for a wide range of spray applications. The ceramic orifice resists wear better than other materials and will provide acre after acre of service.

- ◆ Droplet size balances drift reduction and target coverage
- ◆ Simple and effective pre-orifice design
- ◆ Versatile and long-lasting nozzle
- ◆ PWM system compatible

US UNITS

Nozzle Size	Droplet Size	Pressure (PSI)	Flow Rate (GPM)	Gallons per Acre 20 inch nozzle spacing										GAL/1000 Ft ²			
				MPH										20 inch nozzle spacing			
				4	5	6	8	10	12	15	20	2	3	4	5		
01	M	30	0.09	6.7	5.3	4.5	3.3	2.7	2.2	1.8	1.3	0.31	0.20	0.15	0.12		
	M	40	0.10	7.4	5.9	5.0	3.7	3.0	2.5	2.0	1.5	0.34	0.23	0.17	0.14		
	F	50	0.11	8.2	6.5	5.4	4.1	3.3	2.7	2.2	1.6	0.38	0.25	0.19	0.15		
	F	60	0.12	8.9	7.1	5.9	4.5	3.6	3.0	2.4	1.8	0.41	0.27	0.20	0.16		
	F	70	0.13	9.7	7.7	6.4	4.8	3.9	3.2	2.6	1.9	0.44	0.30	0.22	0.18		
015	M	30	0.13	9.7	7.7	6.4	4.8	3.9	3.2	2.6	1.9	0.44	0.30	0.22	0.18		
	M	40	0.15	11.1	8.9	7.4	5.6	4.5	3.7	3.0	2.2	0.51	0.34	0.26	0.20		
	M	50	0.17	12.6	10.1	8.4	6.3	5.0	4.2	3.4	2.5	0.58	0.39	0.29	0.23		
	M	60	0.18	13.4	10.7	8.9	6.7	5.3	4.5	3.6	2.7	0.61	0.41	0.31	0.25		
	M	70	0.20	14.9	11.9	9.9	7.4	5.9	5.0	4.0	3.0	0.68	0.45	0.34	0.27		
02	M	30	0.17	12.6	10.1	8.4	6.3	5.0	4.2	3.4	2.5	0.58	0.39	0.29	0.23		
	M	40	0.20	14.9	11.9	9.9	7.4	5.9	5.0	4.0	3.0	0.68	0.45	0.34	0.27		
	M	50	0.22	16.3	13.1	10.9	8.2	6.5	5.4	4.4	3.3	0.75	0.50	0.38	0.30		
	M	60	0.24	17.8	14.3	11.9	8.9	7.1	5.9	4.8	3.6	0.82	0.55	0.41	0.33		
	M	70	0.26	19.3	15.4	12.9	9.7	7.7	6.4	5.1	3.9	0.89	0.59	0.44	0.35		
03	C	30	0.26	19.3	15.4	12.9	9.7	7.7	6.4	5.1	3.9	0.89	0.59	0.44	0.35		
	M	40	0.30	22.3	17.8	14.9	11.1	8.9	7.4	5.9	4.5	1.02	0.68	0.51	0.41		
	M	50	0.34	25.2	20.2	16.8	12.6	10.1	8.4	6.7	5.0	1.16	0.77	0.58	0.46		
	M	60	0.37	27.5	22.0	18.3	13.7	11.0	9.2	7.3	5.5	1.26	0.84	0.63	0.50		
	M	70	0.40	29.7	23.8	19.8	14.9	11.9	9.9	7.9	5.9	1.36	0.91	0.68	0.55		
04	VC	30	0.35	26.0	20.8	17.3	13.0	10.4	8.7	6.9	5.2	1.19	0.80	0.60	0.48		
	C	40	0.40	29.7	23.8	19.8	14.9	11.9	9.9	7.9	5.9	1.36	0.91	0.68	0.55		
	C	50	0.45	33.4	26.7	22.3	16.7	13.4	11.1	8.9	6.7	1.53	1.02	0.77	0.61		
	C	60	0.49	36.4	29.1	24.3	18.2	14.6	12.1	9.7	7.3	1.67	1.11	0.84	0.67		
	M	70	0.53	39.4	31.5	26.2	19.7	15.7	13.1	10.5	7.9	1.81	1.20	0.90	0.72		

Droplet size based on ASABE S572.1 standard.

METRIC UNITS

Nozzle Size	Droplet Size	Pressure (BAR)	Flow Rate (L/min)	Gallons per Acre 20 inch nozzle spacing											
				MPH											
				6	8	10	12	14	16	18	20	25	30		
01	F	2	0.33	87	65	52	43	37	33	29	26	21	17		
	F	3	0.40	105	79	63	53	45	39	35	32	25	21		
	F	4	0.46	121	91	73	61	52	45	40	36	29	24		
	VF	5	0.52	137	103	82	68	59	51	46	41	33	27		
02	F	2	0.49	129	97	77	64	55	48	43	39	31	26		
	F	3	0.60	158	118	95	79	68	59	53	47	38	32		
	F	4	0.69	182	136	109	91	78	68	61	54	44	36		
	F	5	0.77	203	152	122	101	87	76	68	61	49	41		
03	M	2	0.65	171	128	103	86	73	64	57	51	41	34		
	M	3	0.80	211	158	126	105	90	79	70	63	51	42		
	F	4	0.92	242	182	145	121	104	91	81	73	58	48		
	F	5	1.03	271	203	163	136	116	102	90	81	65	54		
04	M	2	0.98	258	193	155	129	111	97	86	77	62	52		
	M	3	1.20	316	237	189	158	135	118	105	95	76	63		
	M	4	1.39	366	274	219	183	157	137	122	110	88	73		
	F	5	1.55	408	306	245	204	175	153	136	122	98	82		
05	M	2	1.31	345	259	207	172	148	129	115	103	83	69		
	M	3	1.60	421	316	253	211	180	158	140	126	101	84		
	M	4	1.85	487	365	292	243	209	183	162	146	117	97		
	M	5	2.07	545	409	327	272	233	204	182	163	131	109		
06	M	2	1.96	516	387	309	258	221	193	172	155	124	103		
	M	3	2.40	632	474	379	316	271	237	211	189	152	126		
	M	4	2.77	729	547	437	364	312	273	243	219	175	146		
	M	5	3.10	816	612	489	408	350	306	272	245	196	163		

Droplet size based on ASABE S572.1 standard.

Features	
Common Use	Plant Health
Pattern	Tapered Flat Fan
Technology	Air Induction
Material	Ceramic
Spray Angle	110°
Pressure Range	30-70 PSI (2-5 BAR)
Configuration	Nozzles
Part Numbers	
Nozzles 110°	Caps (25 Pack)
ADI-11001	CAP00-01
ADI-110015	CAP00-015
ADI-11002	CAP00-02
ADI-11003	CAP00-03
ADI-11004	CAP00-04



CERAMIC AXI 80° & 110°



The Albuz® AXI wide pressure range ceramic spray nozzles are suited for creating numerous fine to medium droplets. The ceramic orifice of the AXI will provide long service life even when spraying abrasive chemicals.

- ◆ Adjustable droplet size according to pressure
- ◆ Maintains good spray distribution and makes larger droplets at low pressures
- ◆ FastCap includes nozzle, cap and gasket
- ◆ 80° fan models ideal for use in directed spray applications (See page 178 for more information)

US UNITS

Nozzle Size	Droplet Size		Pressure (PSI)	Flow Rate (GPM)	Gallons per Acre 20 inch nozzle spacing							GAL/1000 Ft ²				
	80°	110°			MPH							20 inch nozzle spacing				
015	F	F	20	0.11	8.2	6.5	5.4	4.1	3.3	2.7	2.2	1.6	0.38	0.25	0.19	0.15
	F	F	30	0.13	9.7	7.7	6.4	4.8	3.9	3.2	2.6	1.9	0.44	0.30	0.22	0.18
	F	F	40	0.15	11.1	8.9	7.4	5.6	4.5	3.7	3.0	2.2	0.51	0.34	0.26	0.20
	F	F	50	0.17	12.6	10.1	8.4	6.3	5.0	4.2	3.4	2.5	0.58	0.39	0.29	0.23
	VF	F	60	0.18	13.4	10.7	8.9	6.7	5.3	4.5	3.6	2.7	0.61	0.41	0.31	0.25
	VF	F	70	0.20	14.9	11.9	9.9	7.4	5.9	5.0	4.0	3.0	0.68	0.45	0.34	0.27
02	F	F	20	0.14	10.4	8.3	6.9	5.2	4.2	3.5	2.8	2.1	0.48	0.32	0.24	0.19
	F	F	30	0.17	12.6	10.1	8.4	6.3	5.0	4.2	3.4	2.5	0.58	0.39	0.29	0.23
	F	F	40	0.20	14.9	11.9	9.9	7.4	5.9	5.0	4.0	3.0	0.68	0.45	0.34	0.27
	F	F	50	0.22	16.3	13.1	10.9	8.2	6.5	5.4	4.4	3.3	0.75	0.50	0.38	0.30
	F	F	60	0.24	17.8	14.3	11.9	8.9	7.1	5.9	4.8	3.6	0.82	0.55	0.41	0.33
	F	F	70	0.26	19.3	15.4	12.9	9.7	7.7	6.4	5.1	3.9	0.89	0.59	0.44	0.35
03	M	M	20	0.21	15.6	12.5	10.4	7.8	6.2	5.2	4.2	3.1	0.72	0.48	0.36	0.29
	M	F	30	0.26	19.3	15.4	12.9	9.7	7.7	6.4	5.1	3.9	0.89	0.59	0.44	0.35
	M	F	40	0.30	22.3	17.8	14.9	11.1	8.9	7.4	5.9	4.5	1.02	0.68	0.51	0.41
	F	F	50	0.34	25.2	20.2	16.8	12.6	10.1	8.4	6.7	5.0	1.16	0.77	0.58	0.46
	F	F	60	0.37	27.5	22.0	18.3	13.7	11.0	9.2	7.3	5.5	1.26	0.84	0.63	0.50
	F	F	70	0.40	29.7	23.8	19.8	14.9	11.9	9.9	7.9	5.9	1.36	0.91	0.68	0.55
04	M	M	20	0.28	20.8	16.6	13.9	10.4	8.3	6.9	5.5	4.2	0.95	0.64	0.48	0.38
	M	M	30	0.35	26.0	20.8	17.3	13.0	10.4	8.7	6.9	5.2	1.19	0.80	0.60	0.48
	M	F	40	0.40	29.7	23.8	19.8	14.9	11.9	9.9	7.9	5.9	1.36	0.91	0.68	0.55
	F	F	50	0.45	33.4	26.7	22.3	16.7	13.4	11.1	8.9	6.7	1.53	1.02	0.77	0.61
	F	F	60	0.49	36.4	29.1	24.3	18.2	14.6	12.1	9.7	7.3	1.67	1.11	0.84	0.67
	F	F	70	0.53	39.4	31.5	26.2	19.7	15.7	13.1	10.5	7.9	1.81	1.20	0.90	0.72
05	M	M	20	0.35	26.0	20.8	17.3	13.0	10.4	8.7	6.9	5.2	1.19	0.80	0.60	0.48
	M	F	30	0.43	31.9	25.5	21.3	16.0	12.8	10.6	8.5	6.4	1.47	0.98	0.73	0.59
	M	F	40	0.50	37.1	29.7	24.8	18.6	14.9	12.4	9.9	7.4	1.71	1.14	0.85	0.68
	F	F	50	0.56	41.6	33.3	27.7	20.8	16.6	13.9	11.1	8.3	1.91	1.27	0.95	0.76
	F	F	60	0.61	45.3	36.2	30.2	22.6	18.1	15.1	12.1	9.1	2.08	1.39	1.04	0.83
	F	F	70	0.66	49.0	39.2	32.7	24.5	19.6	16.3	13.1	9.8	2.25	1.50	1.13	0.90
06	M	M	20	0.42	31.2	24.9	20.8	15.6	12.5	10.4	8.3	6.2	1.43	0.95	0.72	0.57
	M	M	30	0.52	38.6	30.9	25.7	19.3	15.4	12.9	10.3	7.7	1.77	1.18	0.89	0.71
	M	F	40	0.60	44.6	35.6	29.7	22.3	17.8	14.9	11.9	8.9	2.05	1.36	1.02	0.82
	F	F	50	0.67	49.7	39.8	33.2	24.9	19.8	16.6	13.3	9.9	2.28	1.52	1.14	0.91
	F	F	60	0.73	54.2	43.4	36.1	27.1	21.7	18.1	14.5	10.8	2.49	1.66	1.24	1.00
	F	F	70	0.79	58.7	46.9	39.1	29.3	23.5	19.6	15.6	11.7	2.69	1.80	1.35	1.08

Droplet size based on ASABE S572.1 standard.

METRIC UNITS

Nozzle Size	Droplet Size		Pressure (BAR)	Flow Rate (LPM)	Application Rate L/Ha - 50 cm spacing									
	80°	110°			KM/H									
015	F	F	2	0.49	129	97	77	64	55	48	43	39	31	26
	F	F	3	0.60	158	118	95	79	68	59	53	47	38	32
	F	F	4	0.69	182	136	109	91	78	68	61	54	44	36
	F	F	5	0.77	203	152	122	101	87	76	68	61	49	41
	VF	F	5	0.77	203	152	122	101	87	76	68	61	49	41
02	M	F	2	0.85	171	128	103	86	73	64	57	51	41	34
	F	F	3	0.80	211	158	126	105	90	79	70	63	51	42
	F	F	4	0.92	242	182	145	121	104	91	81	73	58	48
	F	F	5	1.03	271	203	163	136	116	102	90	81	65	54
	F	F	5	1.03	271	203	163	136	116	102	90	81	65	54
03	M	F	2	0.98	258	193	155	129	111	97	86	77	62	52
	M	F	3	1.20	316	237	189	158	135	118	105	95	76	63
	F	F	4	1.39	366	274	219	183	157	137	122	110	88	73
	F	F	5	1.55	408	306	245	204	175	153	136	122	98	82
	F	F	5	1.55	408	306	245	204	175	153	136	122	98	82
04	M	M	2	1.31	345	259	207	172	148	129	115	103	83	69
	M	F	3	1.60	421	316	253	211	180	158	140	126	101	84
	M	F	4	1.85	487	365	292	243	209	183	162	146	117	97
	F	F	5	2.07	545	409	327	272	233	204	182	163	131	109
	F	F	5	2.07	545	409	327	272	233	204	182	163	131	109
05	M	M	2	1.63	429	322	257	214	184	161	143	129	103	86
	M	F	3	2.00	526	395	316	263	226	197	175	158	126	105
	M	F	4	2.31	608	456	365	304	261	228	203	182	146	122
	M	F	5	2.58	679	509	407	339	291	255	226	204	163	136
	M	F	5	2.58	679	509	407	339	291	255	226	204	163	136
06	M	M	2	1.96	516	387	309	258	221	193	172	155	124	103
	M	M	3	2.40	632	474	379	316	271	237	211	189	152	126
	M	F	4	2.77	729	547	437	364	312	273	243	219	175	146
	M	F	5	3.10	816	612	489	408	350	306	272	245	196	163
	M	F	5	3.10	816	612	489	408	350	306	272	245	196	163

Droplet size based on ASABE S572.1 standard.

Features	
Common Use	General
Pattern	Tapered Flat Fan
Technology	Elliptical Orifice
Material	Ceramic
Spray Angle	80° & 110°
Pressure Range	20-70 PSI(1.5-5 BAR)
Configuration	Nozzles, FastCap

Optimum Boom Height	
80° - 15' (35 cm) Spacing	22' (56 cm)
80° - 20' (50 cm) Spacing	30' (76 cm)
110° - 15' (35 cm) Spacing	15' (35 cm)
110° - 20' (50 cm) Spacing	20' (50 cm)

Part Numbers	
Nozzles 80°	FastCaps 80°
AXI-80015	FC-AXI-80015
AXI-8002	FC-AXI-8002
AXI-8003	FC-AXI-8003
AXI-8004	FC-AXI-8004
AXI-8005	FC-AXI-8005
AXI-8006	FC-AXI-8006
Nozzles 110°	FastCaps 110°
AXI-110015	FC-AXI-110015
AXI-11002	FC-AXI-11002
AXI-110025	-
AXI-11003	FC-AXI-11003
AXI-11004	FC-AXI-11004
AXI-11005	FC-AXI-11005
AXI-11006	FC-AXI-11006

Replacement Cap Gasket
10BG-2270-0150

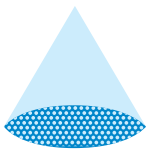

HI-FLOW 140°



The Hypro® Hi-Flow nozzle is the best way to outfit a sprayer to achieve wide-angle coverage plus drift control. The 140° pattern ensures unmatched uniformity across the spray boom and allows lower spray heights to reduce the risk of drift during sensitive applications.

- ◆ Frequently used with fertilizer/herbicide mixtures for early season weed control
- ◆ Straight-through design to reduce clogging and drift
- ◆ Incredibly uniform application across the boom
- ◆ Lower spray heights and pre-orifice technology reduce drift
- ◆ PWM compatible

US UNITS

Nozzle Size	Droplet Size	Pressure (PSI)	Flow Rate (GPM)	MPH - 20 Inch Spacing								MPH - 40 Inch Spacing						MPH - 60 Inch Spacing							
				Gallons per Acre								Gallons per Acre						Gallons per Acre							
				15	30	45	60	75	90	105	15	30	45	60	75	90	105	15	30	45	60	75	90	105	
08	UC 20	30	0.57	11	6	4	3	2	2	2	6	3	2	1	1	1	1	4	2	1	1	1	1	1	1
	UC 30	20	0.69	14	7	5	3	3	2	2	7	3	2	2	1	1	1	5	2	2	1	1	1	1	1
	UC 40	40	0.80	16	8	5	4	3	3	2	8	4	3	2	2	1	1	5	3	2	1	1	1	1	1
	UC 50	50	0.89	18	9	6	4	4	3	3	9	4	3	2	2	1	1	6	3	2	1	1	1	1	1
	XC 60	60	0.98	19	10	6	5	4	3	3	10	5	3	2	2	2	1	6	3	2	2	1	1	1	1
	XC 70	70	1.06	21	10	7	5	4	3	3	10	5	3	2	2	2	1	7	3	2	2	1	1	1	1
XC 80	80	1.13	22	11	7	6	4	4	3	11	6	4	3	2	2	2	7	4	2	2	1	1	1	1	
10	UC 20	30	0.71	14	7	5	4	3	2	2	7	4	2	2	1	1	1	5	2	2	1	1	1	1	1
	UC 30	20	0.87	17	9	6	4	3	2	2	9	4	3	2	2	1	1	6	3	2	1	1	1	1	1
	UC 40	40	1.00	20	10	7	5	4	3	3	10	5	3	2	2	2	1	7	3	2	2	1	1	1	1
	UC 50	50	1.12	22	11	7	6	4	4	3	11	6	4	3	2	2	2	7	4	2	2	1	1	1	1
	XC 60	60	1.22	24	12	8	6	5	4	3	12	6	4	3	2	2	2	8	4	3	2	2	1	1	1
	XC 70	70	1.32	26	13	9	7	5	4	4	13	7	4	3	3	2	2	9	4	3	2	2	1	1	1
XC 80	80	1.41	28	14	9	7	6	5	4	14	7	5	3	3	2	2	9	5	3	2	2	2	1	1	
15	UC 20	20	1.06	21	10	7	5	4	3	3	10	5	3	3	2	2	1	7	3	2	2	1	1	1	1
	UC 30	30	1.30	26	13	9	6	5	4	4	13	6	4	3	3	2	2	9	4	3	2	2	1	1	1
	UC 40	40	1.50	-	15	10	7	6	5	4	15	7	5	4	3	2	2	10	5	3	2	2	2	1	1
	UC 50	50	1.68	-	17	11	8	7	6	5	17	8	6	4	3	3	2	11	6	4	3	2	2	2	2
	XC 60	60	1.84	-	18	12	9	7	6	5	18	9	6	5	4	3	3	12	6	4	3	2	2	2	2
	XC 70	70	1.98	-	20	13	10	8	7	6	20	10	7	5	4	3	3	13	7	4	3	3	2	2	2
XC 80	80	2.12	-	21	14	10	8	7	6	21	10	7	5	4	3	3	14	7	5	3	3	2	2	2	
20	UC 20	20	1.41	28	14	9	7	6	5	4	14	7	5	3	3	2	2	9	5	3	2	2	2	2	1
	UC 30	30	1.73	-	17	11	9	7	6	5	17	9	6	4	3	3	2	11	6	4	3	2	2	2	2
	UC 40	40	2.00	-	20	13	10	8	7	6	20	10	7	5	4	3	3	13	7	4	3	3	2	2	2
	UC 50	50	2.24	-	22	15	11	9	7	6	22	11	7	5	4	4	3	15	7	5	4	3	3	2	2
	XC 60	60	2.45	-	24	16	12	10	8	7	24	12	8	6	5	4	3	16	8	5	4	3	3	2	2
	XC 70	70	2.65	-	26	17	13	10	9	7	26	13	9	6	5	4	4	17	9	6	4	3	3	2	2
XC 80	80	2.83	-	28	18	14	11	9	8	28	14	9	7	6	5	4	18	9	6	5	4	3	3	3	
30	UC 20	20	2.12	-	21	14	10	8	7	6	21	10	7	5	4	3	3	14	7	5	3	3	2	2	2
	UC 30	30	2.60	-	26	17	13	10	9	7	26	13	9	6	5	4	4	17	9	6	4	3	3	3	2
	UC 40	40	3.00	-	30	20	15	12	10	8	30	15	10	7	6	5	4	20	10	7	5	4	3	3	3
	UC 50	50	3.35	-	33	22	17	13	11	10	-	17	11	8	7	6	5	22	11	7	6	4	4	4	3
	XC 60	60	3.67	-	36	24	18	15	12	10	-	18	12	9	7	6	5	24	12	8	6	5	4	4	3
	XC 70	70	3.97	-	39	26	20	16	13	11	-	20	13	10	8	7	6	26	13	9	7	5	4	4	3
XC 80	80	4.24	-	42	28	21	17	14	12	-	21	14	10	8	7	6	28	14	9	7	6	5	4	4	
40	UC 20	20	2.83	-	28	18	14	11	9	8	28	14	9	7	6	5	4	18	9	6	5	4	3	3	3
	UC 30	30	3.46	-	34	23	17	14	12	10	-	17	12	9	7	6	5	23	12	8	6	5	4	4	3
	UC 40	40	4.00	-	40	26	20	16	13	11	-	20	13	10	8	7	6	26	13	9	7	5	4	4	4
	UC 50	50	4.47	-	44	30	22	18	15	13	-	22	15	11	9	7	6	30	15	10	7	6	5	4	4
	XC 60	60	4.90	-	49	33	24	19	16	14	-	24	16	12	10	8	7	-	16	11	8	6	5	5	5
	XC 70	70	5.29	-	52	36	26	21	17	15	-	26	17	13	10	9	7	-	17	12	9	7	6	5	5
XC 80	80	5.66	-	56	39	28	23	19	16	-	28	19	14	11	9	8	-	19	13	9	8	6	5	5	
50	UC 20	20	3.54	-	35	23	17	14	12	10	-	17	12	9	7	6	5	23	12	8	6	5	4	4	3
	UC 30	30	4.33	-	43	28	21	17	14	12	-	21	14	11	9	7	6	28	14	9	7	6	5	4	4
	UC 40	40	5.00	-	50	33	25	20	17	14	-	25	17	12	10	8	7	-	17	11	8	7	6	5	5
	UC 50	50	5.59	-	55	37	28	22	18	16	-	28	18	14	11	9	8	-	18	12	9	7	6	5	5
	XC 60	60	6.12	-	61	41	30	24	20	17	-	30	20	15	12	10	9	-	20	13	10	8	7	6	6
	XC 70	70	6.61	-	66	44	33	26	22	19	-	33	22	16	13	11	9	-	22	15	11	9	7	6	6
XC 80	80	7.07	-	70	47	35	28	23	20	-	35	24	18	14	12	10	-	23	16	12	9	8	7	7	
60	UC 20	20	4.24	-	42	28	21	17	14	12	-	21	14	10	8	7	6	28	14	9	7	6	5	4	4
	UC 30	30	5.20	-	52	34	26	21	17	15	-	26	17	13	10	9	7	-	17	11	9	7	6	5	5
	UC 40	40	6.00	-	60	39	30	24	20	17	-	30	20	15	12	10	8	-	20	13	10	8	7	6	6
	UC 50	50	6.71	-	67	43	32	27	22	19	-	32	22	17	13	11	9	-	22	15	11	9	7	6	7
	XC 60	60	7.35	-	73	47	35	29	24	21	-	35	24	18	14	12	10	-	24	16	12	10	8	7	7
	XC 70	70	7.94	-	79	50	37	30	25	22	-	37	26	20	16	13	11	-	26	17	13	10	9	7	7
XC 80	80	8.49	-	84	53	40	32	26	23	-	40	28	21	17	14	12	-	28	19	14	11	9	8	8	

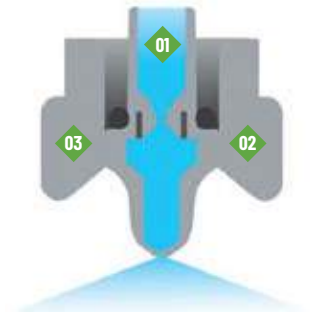

- 01. Straight flow design for superior resistance to plugging and creation of driftable droplets
- 02. Unitized spray nozzle design for easy single piece operation
- 03. Removable pre-orifice for easy cleaning

Droplet size based on ASABE S572.1 standard.



FLOATER ADAPTER FOR HI-FLOW NOZZLES

Part Number	Description
9950-0001	Floater Adapter Kit for Hi-Flow Nozzles (3/4" Cam Lock to Bayonet)



140° wide, large droplet spray pattern for industry leading coverage of liquid fertilizers.



Straight through design squeezes fluid flow to create the spray pattern versus deflecting fluid flow and creating un-needed spray drift.

METRIC UNITS

Nozzle Size	Droplet Size	Pressure (BAR)	Flow Rate (LPM)	Application Rate L/Ha - 50 cm Spacing							
				KM/H							
				7	8	10	12	15	20	25	30
08	UC	1,5	2,26	387	339	271	226	181	136	108	90
	UC	2	2,61	447	392	313	261	209	157	125	104
	UC	2,5	2,92	501	438	350	292	234	175	140	117
	UC	3	3,20	549	480	384	320	256	192	154	128
	XC	4	3,70	634	555	444	370	296	222	178	148
	XC	5	4,13	708	620	496	413	330	248	198	165
10	UC	6	4,53	777	680	544	453	362	272	217	181
	UC	1,5	2,8	480	420	336	280	224	168	134	112
	UC	2	3,3	566	495	396	330	264	198	158	132
	UC	2,5	3,7	634	555	444	370	296	222	178	148
	UC	3	4,0	686	600	480	400	320	240	192	160
	UC	4	4,6	789	690	552	460	368	276	221	184
15	XC	5	5,2	891	780	624	520	416	312	250	208
	XC	6	5,7	977	855	684	570	456	342	274	228
	UC	1,5	4,2	720	630	504	420	336	252	202	168
	UC	2	4,9	840	735	588	490	392	294	235	196
	UC	2,5	5,5	943	825	660	550	440	330	264	220
	UC	3	6,0	1029	900	720	600	480	360	288	240
20	XC	4	6,9	1183	1035	828	690	552	414	331	276
	XC	5	7,7	1320	1155	924	770	616	462	370	308
	XC	6	8,5	1457	1275	1020	850	680	510	408	340
	UC	1,5	5,7	977	855	684	570	456	342	274	228
	UC	2	6,5	1114	975	780	650	520	390	312	260
	UC	2,5	7,3	1251	1095	876	730	584	438	350	292
30	UC	3	8,0	1371	1200	960	800	640	480	384	320
	UC	4	9,2	1577	1380	1104	920	736	552	442	368
	UC	5	10,3	1766	1545	1236	1030	824	618	494	412
	UC	6	11,3	1937	1695	1356	1130	904	678	542	452
	UC	1,5	8,5	1457	1275	1020	850	680	510	408	340
	UC	2	9,8	1680	1470	1176	980	784	588	470	392
40	UC	2,5	11,0	1896	1650	1320	1100	880	660	528	440
	UC	3	12,0	2057	1800	1440	1200	960	720	576	480
	UC	4	13,9	2383	2085	1668	1390	1112	834	667	556
	UC	5	15,5	2657	2325	1860	1550	1240	930	744	620
	UC	6	17,0	2914	2550	2040	1700	1360	1020	816	680
	UC	1,5	11,3	1937	1695	1356	1130	904	678	542	452
50	UC	2	13,1	2246	1965	1572	1310	1048	786	629	524
	UC	2,5	14,6	2503	2190	1752	1460	1168	876	701	584
	UC	3	16,0	2743	2400	1920	1600	1280	960	768	640
	UC	4	18,5	3171	2775	2220	1850	1480	1110	888	740
	UC	5	20,7	3549	3105	2484	2070	1656	1242	994	828
	UC	6	22,6	3874	3390	2712	2260	1808	1356	1085	904
60	UC	1,5	14,1	2417	2115	1692	1410	1128	846	677	564
	UC	2	16,3	2794	2445	1956	1630	1304	978	782	652
	UC	2,5	18,3	3137	2745	2196	1830	1464	1098	878	732
	UC	3	20,0	3429	3000	2400	2000	1600	1200	960	800
	UC	4	23,1	3960	3465	2772	2310	1848	1386	1109	924
	UC	5	25,8	4423	3870	3096	2580	2064	1548	1238	1032
60	XC	6	28,3	4851	4245	3396	2830	2264	1698	1358	1132
	UC	1,5	17,0	2914	2550	2040	1700	1360	1020	816	680
	UC	2	19,6	3360	2940	2352	1960	1568	1176	941	784
	UC	2,5	21,9	3754	3285	2628	2190	1752	1314	1051	876
	UC	3	24,0	4114	3600	2880	2400	1920	1440	1152	960
	UC	4	27,7	4749	4155	3324	2770	2216	1662	1330	1108
60	XC	5	31,0	5314	4650	3720	3100	2480	1860	1488	1240
	XC	6	33,9	5811	5085	4068	3390	2712	2034	1627	1356

Droplet size based on ASABE S572.1 standard.

Features	
Common Use	Fertilizer
Pattern	Tapered Flat Fan
Technology	Pre-Driftice
Material	Polyacetal
Spray Angle	140°
Pressure Range	20-60 PSI (1.5-6 BAR)
Configuration	FastCap
Minimum Boom Height	
15" (35 cm) Spacing	10" (25 cm)
20" (50 cm) Spacing	12" (30 cm)
Part Numbers (Bags of 10)	
FastCaps 140°	
HF140-08	
HF140-10	
HF140-15	
HF140-20	
HF140-30	
HF140-40	
HF140-50	
HF140-60	
Replacement Cap Gasket	
10BG-2270-0150	

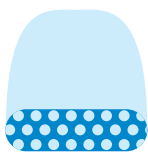

DEFLECTIP 80°-160°



The DeflecTip wide-angle flood fan nozzle creates a wide pattern at very low pressures while creating mainly medium and coarse droplets. It is well suited for mounting on machinery where a wide angle or a low spray height is desired and on sprayers using very low pressures, including manual sprayers.

- ◆ Sprays at very low pressures
- ◆ Medium to coarse spray is suited for a variety of applications
- ◆ Larger sizes are suitable for liquid fertilizer applications
- ◆ Large circular orifice reduces the chances of blocking
- ◆ For use of single nozzles with knapsack/backpack sprayers (See page 196)

US UNITS

Nozzle Size	Droplet Size	Spray Angle @ 22 psi	Pressure (PSI)	Flow Rate (GPM)	Gallons per Acre 20 inch nozzle spacing								GAL/1000ft ²			
					MPH								20 inch nozzle spacing			
					4	5	6	8	10	12	15	20	2	3	4	5
0.5	VC	80°	10	0.05	3.7	3.0	2.5	1.9	1.5	1.2	1.0	0.7	0.17	0.11	0.09	0.07
	M		20	0.07	5.3	4.2	3.5	2.6	2.1	1.8	1.4	1.1	0.24	0.16	0.12	0.10
	F		30	0.09	6.4	5.1	4.3	3.2	2.6	2.1	1.7	1.3	0.30	0.20	0.15	0.12
	F		40	0.10	7.4	5.9	5.0	3.7	3.0	2.5	2.0	1.5	0.34	0.23	0.17	0.14
	F		50	0.11	8.3	6.6	5.5	4.2	3.3	2.8	2.2	1.7	0.38	0.25	0.19	0.15
	F		60	0.12	9.1	7.3	6.1	4.5	3.6	3.0	2.4	1.8	0.42	0.28	0.21	0.17
0.75	XC	95°	10	0.08	5.6	4.5	3.7	2.8	2.2	1.9	1.5	1.1	0.26	0.17	0.13	0.10
	M		20	0.11	7.9	6.3	5.3	3.9	3.2	2.6	2.1	1.6	0.36	0.24	0.18	0.14
	M		30	0.13	9.6	7.7	6.4	4.8	3.9	3.2	2.6	1.9	0.44	0.30	0.22	0.18
	F		40	0.15	11.1	8.9	7.4	5.6	4.5	3.7	3.0	2.2	0.51	0.34	0.26	0.20
	F		50	0.17	12.5	10.0	8.3	6.2	5.0	4.2	3.3	2.5	0.57	0.38	0.29	0.23
	F		60	0.18	13.6	10.9	9.1	6.8	5.5	4.5	3.6	2.7	0.63	0.42	0.31	0.25
1.0	C	105°	10	0.10	7.4	5.9	5.0	3.7	3.0	2.5	2.0	1.5	0.34	0.23	0.17	0.14
	M		20	0.14	10.5	8.4	7.0	5.3	4.2	3.5	2.8	2.1	0.48	0.32	0.24	0.19
	F		30	0.17	12.9	10.3	8.6	6.4	5.1	4.3	3.4	2.6	0.59	0.39	0.30	0.24
	F		40	0.20	14.9	11.9	9.9	7.4	5.9	5.0	4.0	3.0	0.68	0.45	0.34	0.27
	F		50	0.22	16.6	13.3	11.1	8.3	6.6	5.5	4.4	3.3	0.76	0.51	0.38	0.30
	F		60	0.24	18.2	14.5	12.1	9.1	7.3	6.1	4.8	3.6	0.84	0.56	0.42	0.33
1.5	VC	105°	10	0.15	11.1	8.9	7.4	5.6	4.5	3.7	3.0	2.2	0.51	0.34	0.26	0.20
	M		20	0.21	15.8	12.6	10.5	7.9	6.3	5.3	4.2	3.2	0.72	0.48	0.36	0.29
	M		30	0.26	19.3	15.4	12.9	9.6	7.7	6.4	5.1	3.9	0.89	0.59	0.44	0.35
	F		40	0.30	22.3	17.8	14.9	11.1	8.9	7.4	5.9	4.5	1.02	0.68	0.51	0.41
	F		50	0.34	24.9	19.9	16.6	12.5	10.0	8.3	6.6	5.0	1.14	0.76	0.57	0.46
	F		60	0.37	27.3	21.8	18.2	13.6	10.9	9.1	7.3	5.5	1.25	0.84	0.63	0.50
2.0	M	105°	10	0.20	14.9	11.9	9.9	7.4	5.9	5.0	4.0	3.0	0.68	0.45	0.34	0.27
	M		20	0.28	21.0	16.8	14.0	10.5	8.4	7.0	5.6	4.2	0.96	0.64	0.48	0.39
	M		30	0.35	25.7	20.6	17.1	12.9	10.3	8.6	6.9	5.1	1.18	0.79	0.59	0.47
	F		40	0.40	29.7	23.8	19.8	14.9	11.9	9.9	7.9	5.9	1.36	0.91	0.68	0.55
	F		50	0.45	33.2	26.6	22.1	16.6	13.3	11.1	8.9	6.6	1.52	1.02	0.76	0.61
	F		60	0.49	36.4	29.1	24.2	18.2	14.5	12.1	9.7	7.3	1.67	1.11	0.84	0.67
2.5	C	110°	10	0.25	18.6	14.9	12.4	9.3	7.4	6.2	5.0	3.7	0.85	0.57	0.43	0.34
	M		20	0.35	26.3	21.0	17.5	13.1	10.5	8.8	7.0	5.3	1.21	0.80	0.60	0.48
	M		30	0.43	32.2	25.7	21.4	16.1	12.9	10.7	8.6	6.4	1.48	0.98	0.74	0.59
	M		40	0.50	37.1	29.7	24.8	18.6	14.9	12.4	9.9	7.4	1.70	1.14	0.85	0.68
	F		50	0.56	41.5	33.2	27.7	20.8	16.6	13.8	11.1	8.3	1.91	1.27	0.95	0.76
	F		60	0.61	45.5	36.4	30.3	22.7	18.2	15.2	12.1	9.1	2.09	1.39	1.04	0.84
3.0	C	110°	10	0.30	22.3	17.8	14.9	11.1	8.9	7.4	5.9	4.5	1.02	0.68	0.51	0.41
	M		20	0.42	31.5	25.2	21.0	15.8	12.6	10.5	8.4	6.3	1.45	0.96	0.72	0.58
	M		30	0.52	38.6	30.9	25.7	19.3	15.4	12.9	10.3	7.7	1.77	1.18	0.89	0.71
	M		40	0.60	44.6	35.6	29.7	22.3	17.8	14.9	11.9	8.9	2.05	1.36	1.02	0.82
	M		50	0.67	49.8	39.8	33.2	24.9	19.9	16.6	13.3	10.0	2.29	1.52	1.14	0.91
	M		60	0.73	54.6	43.6	36.4	27.3	21.8	18.2	14.5	10.9	2.51	1.67	1.25	1.00
4.0	M	120°	10	0.40	29.7	23.8	19.8	14.9	11.9	9.9	7.9	5.9	1.36	0.91	0.68	0.55
	M		20	0.57	42.0	33.6	28.0	21.0	16.8	14.0	11.2	8.4	1.93	1.29	0.96	0.77
	M		30	0.69	51.4	41.2	34.3	25.7	20.6	17.1	13.7	10.3	2.36	1.57	1.18	0.94
	M		40	0.80	59.4	47.5	39.6	29.7	23.8	19.8	15.8	11.9	2.73	1.82	1.36	1.09
	M		50	0.89	66.4	53.1	44.3	33.2	26.6	22.1	17.7	13.3	3.05	2.03	1.52	1.22
	F		60	0.98	72.7	58.2	48.5	36.4	29.1	24.2	19.4	14.5	3.34	2.23	1.67	1.34
5.0	M	125°	10	0.50	37.1	29.7	24.8	18.6	14.9	12.4	9.9	7.4	1.70	1.14	0.85	0.68
	M		20	0.71	52.5	42.0	35.0	26.3	21.0	17.5	14.0	10.5	2.41	1.61	1.21	0.96
	M		30	0.87	64.3	51.4	42.9	32.2	25.7	21.4	17.1	12.9	2.95	1.97	1.48	1.18
	M		40	1.00	74.3	59.4	49.5	37.1	29.7	24.8	19.8	14.9	3.41	2.27	1.70	1.36
	F		50	1.12	83.0	66.4	55.3	41.5	33.2	27.7	22.1	16.6	3.81	2.54	1.91	1.52
	F		60	1.22	90.9	72.7	60.6	45.5	36.4	30.3	24.2	18.2	4.18	2.78	2.09	1.67
7.5	C	145°	10	0.75	55.7	44.6	37.1	27.8	22.3	18.6	14.9	11.1	2.56	1.70	1.28	1.02
	C		20	1.06	78.8	63.0	52.5	39.4	31.5	26.3	21.0	15.8	3.62	2.41	1.81	1.45
	C		30	1.30	96.5	77.2	64.3	48.2	38.6	32.2	25.7	19.3	4.43	2.95	2.21	1.77
	C		40	1.50	111.4	89.1	74.3	55.7	44.6	37.1	29.7	22.3	5.11	3.41	2.56	2.05
	C		50	1.68	124.5	99.6	83.0	62.3	49.8	41.5	33.2	24.9	5.72	3.81	2.86	2.29
	M		60	1.84	136.4	109.1	90.9	68.2	54.6	45.5	36.4	27.3	6.26	4.18	3.13	2.51
10	C	160°	10	1.00	74.3	59.4	49.5	37.1	29.7	24.8	19.8	14.9	3.41	2.27	1.70	1.36
	M		20	1.41	105.0	84.0	70.0	52.5	42.0	35.0	28.0	21.0	4.82	3.21	2.41	1.93
	M		30	1.73	128.6	102.9	85.7	64.3	51.4	42.9	34.3	25.7	5.90	3.94	2.95	2.36
	M		40	2.00	148.5	118.8	99.0	74.3	59.4	49.5	39.6	29.7	6.82	4.55	3.41	2.73
	M		50	2.24	166.0	132.8	110.7	83.0	66.4	55.3	44.3	33.2	7.62	5.08	3.81	3.05
	F		60	2.45	181.9	145.5	121.2	90.9	72.7	60.6	48.5	36.4	8.35	5.57	4.18	3.34
15	C	145°	10	1.50	111.4	89.1	74.3	55.7	44.6	37.1	29.7	22.3	5.11	3.41	2.56	2.05
	C		20	2.12	157.5	126.0	105.0	78.8	63.0	52.5	42.0	31.5	7.23	4.82	3.62	2.89
	C		30	2.60	192.9	154.3	128.6	96.5	77.2	64.3	51.4	38.6	8.86	5.90	4.43	3.54
	C		40	3.00	222.8	178.2	148.5	111.4	89.1	74.3	59.4	44.6	10.23	6.82	5.11	4.09
	C		50	3.35	249.0	199.2	166.0	124.5	99.6	83.0	66.4	49.8	11.43	7.62	5.72	4.57
	M		60	3.67	272.8	218.2	181.9	136.4	109.1	90.9	72.7	54.6	12.53	8.35	6.26	5.01
20	VC	140°	10	2.00	148.5	118.8	99.0	74.3	59.4	49.5	39.6	29.7	6.82	4.55	3.41	2.73
	C		20	2.83	210.0	168.0	140.0	105.0	84.0	70.0	56.0	42.0	9.64	6.43	4.82	3.86
	C		30	3.46	257.2	205.8	171.5	128.6	102.9	85.7	68.6	51.4	11.81	7.87	5.90	4.76
	C		40	4.00	297.0	237.6	198.0	148.5	118.8	99.0	79.2	59.4	13.64	9.09	6.82	5.45
	C		50	4.47	332.1	265.6	221.4	166.0	132.8	110.7	88.5	66.4	15.25	10.16	7.62	6.10
	C		60	4.90	363.7	291.0	242.5	181.9	145.5	121.2	97.0	72.7	16.70	11.13	8.35	6.68

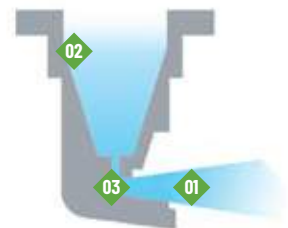

01. Simple; deflecting spray pattern
02. Polyacetal; single piece design
03. Available in many sizes to meet your flow rate needs

METRIC UNITS

Nozzle Size	Droplet Size	Spray Angle @ 1.5 bar	Pressure (BAR)	Flow Rate (LPM)	Application Rate L/Ha - 50 cm Spacing							
					KM/H							
					7	8	10	12	15	20	25	30
0.5	VC	80°	1.0	0.23	39	34	27	23	18	14	11	9
	M		1.5	0.28	48	42	34	28	22	17	13	11
	F		2.0	0.32	55	48	39	32	26	19	15	13
	F		2.5	0.36	62	54	43	36	29	22	17	14
	F		3.0	0.39	68	59	47	39	32	24	19	16
	F		4.0	0.46	78	68	55	46	36	27	22	18
0.75	XC	95°	1.0	0.34	59	51	41	34	27	21	16	14
	M		1.5	0.42	72	63	50	42	34	25	20	17
	F		2.0	0.48	83	73	58	48	39	29	23	19
	F		2.5	0.54	93	81	65	54	43	32	26	22
	F		3.0	0.59	102	89	71	59	47	36	28	24
	F		4.0	0.68	117	103	82	68	55	41	33	27
1.0	C	105°	1.0	0.46	78	68	55	46	36	27	22	18
	M		1.5	0.56	96	84	67	56	45	34	27	22
	F		2.0	0.64	111	97	77	64	52	39	31	26
	F		2.5	0.72	124	108	86	72	58	43	35	29
	F		3.0	0.79	135	118	95	79	63	47	38	32
	F		4.0	0.91	156	137	109	91	73	55	44	36
1.5	VC	105°	1.0	0.68	117	103	82	68	55	41	33	27
	M		1.5	0.84	144	126	101	84	67	50	40	34
	M		2.0	0.97	166	145	116	97	77	58	46	39
	F		2.5	1.08	185	162	130	108	86	65	52	43
	F		3.0	1.18	203	178	142	118	95	71	57	47
	F		4.0	1.37	234	205	164	137	109	82	66	55
2.0	M	105°	1.0	0.91	156	137	109	91	73	55	44	36
	M		1.5	1.12	191	168	134	112	89	67	54	45
	M		2.0	1.29	221	193	155	129	103	77	62	52
	F		2.5	1.44	247	216	173	144	115	86	69	58
	F		3.0	1.58	271	237	190	158	126	95	76	63
	F		4.0	1.82	313	274	219	182	146	109	88	73
2.5	C	110°	1.0	1.14	195	171	137	114	91	68	55	46
	M		1.5	1.40	239	209	168	140	112	84	67	56
	M		2.0	1.61	276	242	193	161	129	97	77	64
	M		2.5	1.80	309	270	216	180	144	108	86	72
	F		3.0	1.97	338	296	237	197	158	118	95	79
	F		4.0	2.28	391	342	274	228	182	137	109	91
3.0	C	110°	1.0	1.37	234	205	164	137	109	82	66	55
	M		1.5	1.68	287	251	201	168	134	101	80	67
	M		2.0	1.93	332	290	232	193	155	116	93	77
	M		2.5	2.16	371	324	259	216	173	130	104	86
	M		3.0	2.37	406	355	284	237	190	142	114	95
	M		4.0	2.74	469	410	328	274	219	164	131	109
4.0	M	120°	1.0	1.82	313	274	219	182	146	109	88	73
	M		1.5	2.23	383	335	268	223	179	134	107	89
	M		2.0	2.58	442	387	309	258	206	155	124	103
	M		2.5	2.88	494	432	346	288	231	173	138	115
	M		3.0	3.16	541	474	379	316	253	190	152	126
	F		4.0	3.65	625	547	438	365	292	219	175	146
5.0	M	125°	1.0	2.3	391	342	274	228	182	137	109	91
	M		1.5	2.8	479	419	335	279	223	168	134	112
	M		2.0	3.2	553	484	387	322	258	193	155	129
	M		2.5	3.6	618	541	432	360	288	216	173	144
	F		3.0	3.9	677	592	474	395	316	237	190	158
	F		4.0	4.6	782	684	547	456	365	274	219	182
7.5	C	145°	1.0	3.4	586	513	410	342	274	205	164	137
	C		1.5	4.2	718	628	503	419	335	251	201	168
	C		2.0	4.8	829	725	580	484	387	290	232	193
	C		2.5	5.4	927	811	649	541	432	324	259	216
	C		3.0	5.9	1015	888	711	592	474	355	284	237
	M		4.0	6.8	1172	1026	821	684	547	410	328	274
10	C	160°	1.0	4.6	782	684	547	456	365	274	219	182
	M		1.5	5.6	957	838	670	558	447	335	268	223
	M		2.0	6.4	1105	967	774	645	516	387	309	258
	M		2.5	7.2	1236	1081	865	721	577	432	346	288
	M		3.0	7.9	1354	1184	948	790	632	474	379	316
	M		4.0	9.1	1563	1368	1094	912	729	547	438	365
15	C	145°	1.0	6.8	1172	1026	821	684	547	410	328	274
	C		1.5	8.4	1436	1256	1005	838	670	503	402	335
	C		2.0	9.7	1658	1451	1160	967	774	580	464	387
	C		2.5	10.8	1854	1622	1297	1081	865	649	519	432
	C		3.0	11.8	2030	1777	1421	1184	948	711	569	474
	M		4.0	13.7	2345	2051	1641	1368	1094	821	656	547
20	VC	140°	1.0	9.1	1563	1368	1094	912	729	547	438	365
	C		1.5	11.2	1914	1675	1340	1117	893	670	536	447
	C		2.0	12.9	2210	1934	1547	1289	1032	774	619	516
	C		2.5	14.4	2471	2162	1730	1442	1153	865	692	577
	C		3.0	15.8	2707	2369	1895	1579	1263	948	758	632
	C		4.0	18.2	3126	2735	2188	1824	1459	1094	875	729

Droplet size based on ASABE S572.1 standard.

Features	
Common Use	Weeds & Fertilizer
Pattern	Flood
Technology	Deflection
Material	Polycetal
Spray Angle	80°-160°
Pressure Range	10-60 PSI (1-3 BAR)
Configuration	Nozzle
Part Numbers (Bags of 10)	
Nozzles	Caps (25 Pack)
30DT0.5	CAP30-20
30DT0.75	CAP30-20
30DT1.0	CAP30-20
30DT1.5	CAP30-20
30DT2.0	CAP30-20
30DT2.5	CAP30-20
30DT3.0	CAP30-20
30DT4.0	CAP30-20
30DT5.0	CAP30-20
30DT7.5	CAP30-20
30DT10	CAP30-20
30DT15	CAP30-20
30DT20	CAP30-20



ESI SIX STREAM



The ESI six stream nozzle is designed for applying liquid fertilizer. It creates six individual streams that distribute the fertilizer on the soil while getting less on the crop. The wear resistant metering orifice and unique low pressure distribution chamber keep the streams stable to reduce atomization and prevent leaf burn and scorching. Spacing and spray height is similar to 110° broadcast nozzles.

- ◆ Six streams distribute fertilizer more evenly than one single stream
- ◆ Wear-resistant orifice for long product life
- ◆ FastCap includes nozzle, cap and gasket

US UNITS

Nozzle Size	Pressure (PSI)	Flow Rate (GPM)	Speed (MPH) - 20 inch nozzle spacing															
			Gallons per Acre															
			2.5	5	7.5	10	12.5	15	17.5	20	22.5	25	27.5	30	32.5	35	37.5	40
015	15	0.09	10.9	5.5	3.6	2.7	2.2	1.8	1.6	1.4	1.2	1.1	1.0	0.8	0.8	0.7	0.7	
	20	0.11	12.6	6.3	4.2	3.2	2.5	2.1	1.8	1.6	1.4	1.3	1.1	1.0	0.9	0.8	0.8	
	30	0.13	15.4	7.7	5.1	3.9	3.1	2.6	2.2	1.9	1.7	1.5	1.4	1.3	1.2	1.1	1.0	
	40	0.15	17.8	8.9	5.9	4.5	3.6	3.0	2.5	2.2	2.0	1.8	1.6	1.5	1.4	1.3	1.2	
	50	0.17	19.9	10.0	6.6	5.0	4.0	3.3	2.8	2.5	2.2	2.0	1.8	1.7	1.5	1.4	1.3	
	60	0.18	21.8	10.9	7.3	5.5	4.4	3.6	3.1	2.7	2.4	2.2	2.0	1.8	1.7	1.6	1.5	
02	15	0.12	14.5	7.3	4.8	3.6	2.9	2.4	2.1	1.8	1.6	1.5	1.3	1.2	1.1	1.0	0.9	
	20	0.14	16.8	8.4	5.6	4.2	3.4	2.8	2.4	2.1	1.9	1.7	1.5	1.4	1.3	1.2	1.1	
	30	0.17	20.6	10.3	6.9	5.1	4.1	3.4	2.9	2.6	2.3	2.1	1.9	1.7	1.6	1.5	1.4	
	40	0.20	23.8	11.9	7.9	5.9	4.8	4.0	3.4	3.0	2.6	2.4	2.2	2.0	1.8	1.7	1.6	
	50	0.22	26.6	13.3	8.9	6.6	5.3	4.4	3.8	3.3	3.0	2.7	2.4	2.2	2.0	1.9	1.8	
	60	0.24	29.1	14.5	9.7	7.3	5.8	4.8	4.2	3.6	3.2	2.9	2.6	2.4	2.2	2.1	1.9	
025	15	0.15	18.2	9.1	6.1	4.5	3.6	3.0	2.6	2.3	2.0	1.8	1.7	1.5	1.4	1.3	1.2	
	20	0.18	21.0	10.5	7.0	5.3	4.2	3.5	3.0	2.6	2.3	2.1	1.9	1.8	1.6	1.5	1.4	
	30	0.22	25.7	12.9	8.6	6.4	5.1	4.3	3.7	3.2	2.9	2.6	2.3	2.1	2.0	1.8	1.7	
	40	0.25	29.7	14.9	9.9	7.4	5.9	5.0	4.2	3.7	3.3	3.0	2.7	2.5	2.3	2.1	2.0	
	50	0.28	-	16.6	11.1	8.3	6.6	5.5	4.7	4.2	3.7	3.3	3.0	2.8	2.6	2.4	2.2	
	60	0.31	-	18.2	12.1	9.1	7.3	6.1	5.2	4.5	4.0	3.6	3.3	3.0	2.8	2.6	2.4	
03	15	0.18	21.8	10.9	7.3	5.5	4.4	3.6	3.1	2.7	2.4	2.2	2.0	1.8	1.7	1.6	1.5	
	20	0.21	25.2	12.6	8.4	6.3	5.0	4.2	3.6	3.2	2.8	2.5	2.3	2.1	1.9	1.8	1.7	
	30	0.26	-	15.4	10.3	7.7	6.2	5.1	4.4	3.9	3.4	3.1	2.8	2.6	2.4	2.2	2.1	
	40	0.30	-	17.8	11.9	8.9	7.1	5.9	5.1	4.5	4.0	3.6	3.2	3.0	2.7	2.5	2.4	
	50	0.34	-	19.9	13.3	10.0	8.0	6.6	5.7	5.0	4.4	4.0	3.6	3.3	3.1	2.8	2.7	
	60	0.37	-	21.8	14.5	10.9	8.7	7.3	6.2	5.5	4.8	4.4	4.0	3.6	3.4	3.1	2.9	
04	15	0.24	29.1	14.5	9.7	7.3	5.8	4.8	4.2	3.6	3.2	2.9	2.6	2.4	2.2	2.1	1.9	
	20	0.28	-	16.8	11.2	8.4	6.7	5.6	4.8	4.2	3.7	3.4	3.1	2.8	2.6	2.4	2.2	
	30	0.35	-	20.6	13.7	10.3	8.2	6.9	5.9	5.1	4.6	4.1	3.7	3.4	3.2	2.9	2.7	
	40	0.40	-	23.8	15.8	11.9	9.5	7.9	6.8	5.9	5.3	4.8	4.3	4.0	3.7	3.4	3.2	
	50	0.45	-	26.6	17.7	13.3	10.6	8.9	7.6	6.6	5.9	5.3	4.8	4.4	4.1	3.8	3.5	
	60	0.49	-	29.1	19.4	14.5	11.6	9.7	8.3	7.3	6.5	5.8	5.3	4.8	4.5	4.2	3.9	
05	15	0.31	-	18.2	12.1	9.1	7.3	6.1	5.2	4.5	4.0	3.6	3.3	3.0	2.8	2.6	2.4	
	20	0.35	-	21.0	14.0	10.5	8.4	7.0	6.0	5.3	4.7	4.2	3.8	3.5	3.2	3.0	2.8	
	30	0.43	-	25.7	17.1	12.9	10.3	8.6	7.3	6.4	5.7	5.1	4.7	4.3	4.0	3.7	3.4	
	40	0.50	-	29.7	19.8	14.9	11.9	9.9	8.5	7.4	6.6	5.9	5.4	5.0	4.6	4.2	4.0	
	50	0.56	-	-	22.1	16.6	13.3	11.1	9.5	8.3	7.4	6.6	6.0	5.5	5.1	4.7	4.4	
	60	0.61	-	-	24.2	18.2	14.5	12.1	10.4	9.1	8.1	7.3	6.6	6.1	5.6	5.2	4.8	
06	15	0.37	-	21.8	14.5	10.9	8.7	7.3	6.2	5.5	4.8	4.4	4.0	3.6	3.4	3.1	2.9	
	20	0.42	-	25.2	16.8	12.6	10.1	8.4	7.2	6.3	5.6	5.0	4.6	4.2	3.9	3.6	3.4	
	30	0.52	-	-	20.6	15.4	12.3	10.3	8.8	7.7	6.9	6.2	5.6	5.1	4.7	4.4	4.1	
	40	0.60	-	-	23.8	17.8	14.3	11.9	10.2	8.9	7.9	7.1	6.5	5.9	5.5	5.1	4.8	
	50	0.67	-	-	26.6	19.9	15.9	13.3	11.4	10.0	8.9	8.0	7.2	6.6	6.1	5.7	5.3	
	60	0.73	-	-	29.1	21.8	17.5	14.5	12.5	10.9	9.7	8.7	7.9	7.3	6.7	6.2	5.8	
08	15	0.49	-	29.1	19.4	14.5	11.6	9.7	8.3	7.3	6.5	5.8	5.3	4.8	4.5	4.2	3.9	
	20	0.57	-	-	22.4	16.8	13.4	11.2	9.6	8.4	7.5	6.7	6.1	5.6	5.2	4.8	4.5	
	30	0.69	-	-	27.4	20.6	16.5	13.7	11.8	10.3	9.1	8.2	7.5	6.9	6.3	5.9	5.5	
	40	0.80	-	-	-	23.8	19.0	15.8	13.6	11.9	10.6	9.5	8.6	7.9	7.3	6.8	6.3	
	50	0.89	-	-	-	26.6	21.3	17.7	15.2	13.3	11.8	10.6	9.7	8.9	8.2	7.6	7.1	
	60	0.98	-	-	-	29.1	23.3	19.4	16.6	14.5	12.9	11.6	10.6	9.7	9.0	8.3	7.8	
10	15	0.61	-	-	24.2	18.2	14.5	12.1	10.4	9.1	8.1	7.3	6.6	6.1	5.6	5.2	4.8	
	20	0.71	-	-	28.0	21.0	16.8	14.0	12.0	10.5	9.3	8.4	7.6	7.0	6.5	6.0	5.6	
	30	0.87	-	-	-	25.7	20.6	17.1	14.7	12.9	11.4	10.3	9.4	8.6	7.9	7.3	6.9	
	40	1.00	-	-	-	29.7	23.8	19.8	17.0	14.9	13.2	11.9	10.8	9.9	9.1	8.5	7.9	
	50	1.12	-	-	-	-	26.6	22.1	19.0	16.6	14.8	13.3	12.1	11.1	10.2	9.5	8.9	
	60	1.22	-	-	-	-	29.1	24.2	20.8	18.2	16.2	14.5	13.2	12.1	11.2	10.4	9.7	
15	15	0.92	-	-	-	27.3	21.8	18.2	15.6	13.6	12.1	10.9	9.9	9.1	8.4	7.8	7.3	
	20	1.06	-	-	-	-	25.2	21.0	18.0	15.8	14.0	12.6	11.5	10.5	9.7	9.0	8.4	
	30	1.30	-	-	-	-	-	25.7	22.0	19.3	17.1	15.4	14.0	12.9	11.9	11.0	10.3	
	40	1.50	-	-	-	-	-	29.7	25.5	22.3	19.8	17.8	16.2	14.9	13.7	12.7	11.9	
	50	1.68	-	-	-	-	-	-	28.5	24.9	22.1	19.9	18.1	16.6	15.3	14.2	13.3	
	60	1.84	-	-	-	-	-	-	-	27.3	24.2	21.8	19.8	18.2	16.8	15.6	14.5	
20	15	1.22	-	-	-	-	29.1	24.2	20.8	18.2	16.2	14.5	13.2	12.1	11.2	10.4	9.7	
	20	1.41	-	-	-	-	-	28.0	24.0	21.0	18.7	16.8	15.3	14.0	12.9	12.0	11.2	
	30	1.73	-	-	-	-	-	-	29.4	25.7	22.9	20.6	18.7	17.1	15.8	14.7	13.7	
	40	2.00	-	-	-	-	-	-	-	29.7	26.4	23.8	21.6	19.8	18.3	17.0	15.8	
	50	2.24	-	-	-	-	-	-	-	-	29.5	26.6	24.1	22.1	20.4	19.0	17.7	
	60	2.45	-	-	-	-	-	-	-	-	-	29.1	26.5	24.2	22.4	20.8	19.4	

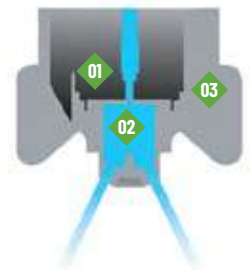

01. Single inlet; Six outlet design for uniform application
02. Pre-orifice; superior product life
03. Available in a FastCap option for easy installation of a streaming nozzle



110° wide pattern consisting of 6 equally spaced streams providing uniform deposition of liquid fertilizers. Each individual stream was engineered to hold stream integrity and not break apart to avoid unwanted fertilizer burn on post emerge applications.

METRIC UNITS

Nozzle Size	Pressure (BAR)	Flow Rate (LPM)	Application Rate L/Ha -50 cm Spacing							
			KM/H							
			7	8	10	12	15	20	25	30
015	1	0.35	60	53	42	35	28	21	17	14
	1.5	0.42	72	63	50	42	34	25	20	17
	2	0.49	84	74	59	49	39	29	24	20
	2.5	0.55	94	83	66	55	44	33	26	22
	3	0.60	103	90	72	60	48	36	29	24
4	0.69	118	104	83	69	55	41	33	28	
02	1	0.46	79	69	55	46	37	28	22	18
	1.5	0.57	98	86	68	57	46	34	27	23
	2	0.65	111	98	78	65	52	39	31	26
	2.5	0.73	125	110	88	73	58	44	35	29
	3	0.80	137	120	96	80	64	48	38	32
4	0.92	158	138	110	92	74	55	44	37	
025	1	0.58	99	87	70	58	46	35	28	23
	1.5	0.71	122	107	85	71	57	43	34	28
	2	0.82	141	123	98	82	66	49	39	33
	2.5	0.91	156	137	109	91	73	55	44	36
	3	1.00	171	150	120	100	80	60	48	40
4	1.15	197	173	138	115	92	69	55	46	
03	1	0.69	118	104	83	69	55	41	33	28
	1.5	0.85	146	128	102	85	68	51	41	34
	2	0.98	168	147	118	98	78	59	47	39
	2.5	1.10	189	165	132	110	88	66	53	44
	3	1.20	206	180	144	120	96	72	58	48
4	1.39	238	209	167	139	111	83	67	56	
04	1	0.92	158	138	110	92	74	55	44	37
	1.5	1.13	194	170	136	113	90	68	54	45
	2	1.31	225	197	157	131	105	79	63	52
	2.5	1.46	250	219	175	146	117	88	70	58
	3	1.60	274	240	192	160	128	96	77	64
4	1.85	317	278	222	185	148	111	89	74	
05	1	1.15	197	173	138	115	92	69	55	46
	1.5	1.41	242	212	169	141	113	85	68	56
	2	1.63	279	245	196	163	130	98	78	65
	2.5	1.83	314	275	220	183	146	110	88	73
	3	2.00	343	300	240	200	160	120	96	80
4	2.31	396	347	277	231	185	139	111	92	
06	1	1.39	238	209	167	139	111	83	67	56
	1.5	1.70	291	255	204	170	136	102	82	68
	2	1.96	336	294	235	196	157	118	94	78
	2.5	2.19	375	329	263	219	175	131	105	88
	3	2.40	411	360	288	240	192	144	115	96
4	2.77	475	416	332	277	222	166	133	111	
08	1	1.85	317	278	222	185	148	111	89	74
	1.5	2.26	387	339	271	226	181	136	108	90
	2	2.61	447	392	313	261	209	157	125	104
	2.5	2.92	501	438	350	292	234	175	140	117
	3	3.20	549	480	384	320	256	192	154	128
4	3.70	634	555	444	370	296	222	178	148	
10	1	2.3	394	345	276	230	184	138	110	92
	1.5	2.8	480	420	336	280	224	168	134	112
	2	3.3	566	495	396	330	264	198	158	132
	2.5	3.7	634	555	444	370	296	222	178	148
	3	4.0	686	600	480	400	320	240	192	160
4	4.6	789	690	552	460	368	276	221	184	
15	1	3.5	600	525	420	350	280	210	168	140
	1.5	4.2	720	630	504	420	336	252	202	168
	2	4.9	840	735	588	490	392	294	235	196
	2.5	5.5	943	825	660	550	440	330	264	220
	3	6.0	1029	900	720	600	480	360	288	240
4	6.9	1183	1035	828	690	552	414	331	276	
20	1	4.6	789	690	552	460	368	276	221	184
	1.5	5.7	977	855	684	570	456	342	274	228
	2	6.5	1114	975	780	650	520	390	312	260
	2.5	7.3	1251	1095	876	730	584	438	350	292
	3	8.0	1371	1200	960	800	640	480	384	320
4	9.2	1577	1380	1104	920	736	552	442	368	

Features		
Common Use	Fertilizer	
Pattern	Streams	
Technology	Pre-Orifice	
Material	Ceramic or Polyacetal	
Spray Angle	110° Equivalent	
Pressure Range	15-60 PSI (1-4 BAR)	
Configuration	Nozzle, FastCap	
Optimum Boom Height		
15° (35 cm) Spacing	15° (35 cm)	
20° (50 cm) Spacing	20° (50 cm)	
Part Numbers (Bags of 10)		
Nozzles 110°	FastCaps 110°	FastCaps 110°
Ceramic Orifice	Ceramic Orifice	Polyacetal Orifice
ESI-110015	FC-ESI-110015*	FC-ESI-110015P
ESI-11002	FC-ESI-11002*	FC-ESI-11002P
ESI-110025	FC-ESI-110025*	-
ESI-11003	FC-ESI-11003*	FC-ESI-11003P
ESI-11004	FC-ESI-11004*	FC-ESI-11004P
ESI-11005	FC-ESI-11005*	FC-ESI-11005P
ESI-11006	FC-ESI-11006*	FC-ESI-11006P
-	FC-ESI-11008	-
-	FC-ESI-11010	-
-	FC-ESI-11015	-
-	-	FC-ESI-11020P
Replacement Cap Gasket		
10BG-2270-0150	Flat seal (sizes 015-06)	
65-BS205	O-ring (sizes 08-15)	

* Uses flat sealing gasket.



FLOW REGULATING DISC DC



The Hypro Flow Regulating Disc - DC is commonly paired with push-to-connect products in liquid fertilizer systems onboard planting equipment.

- ◆ Regulates flow and produces a straight stream pattern
- ◆ Precision-molded in polyacetal for reliable performance
- ◆ Conveniently packaged in a quantity of ten

US UNITS

Disc	US Gallon/Min Pressure (PSI)										
	10	15	20	25	30	35	40	60	80	100	150
30-DC-00	0	0	0	0	0	0	0	0	0	0	0
30-DC010	0.008	0.010	0.011	0.013	0.014	0.015	0.016	0.020	0.023	0.025	0.031
30-DC-018	0.030	0.037	0.042	0.047	0.052	0.056	0.060	0.073	0.085	0.095	0.116
30-DC-023	0.038	0.047	0.054	0.060	0.066	0.071	0.076	0.093	0.107	0.120	0.147
30-DC-01	0.057	0.070	0.081	0.090	0.099	0.107	0.114	0.140	0.161	0.180	0.221
30-DC-015	0.078	0.096	0.110	0.123	0.135	0.146	0.156	0.191	0.221	0.247	0.302
30-DC-02	0.105	0.129	0.148	0.166	0.182	0.196	0.210	0.257	0.297	0.332	0.407
30-DC-03	0.133	0.163	0.188	0.210	0.230	0.249	0.266	0.326	0.376	0.421	0.515
30-DC-035	0.175	0.214	0.247	0.277	0.303	0.327	0.350	0.429	0.495	0.553	0.678
30-DC-04	0.242	0.296	0.342	0.383	0.419	0.453	0.484	0.593	0.684	0.765	0.937
30-DC-05	0.392	0.480	0.554	0.620	0.679	0.733	0.784	0.960	1.11	1.24	1.52
30-DC-06	0.570	0.698	0.806	0.901	0.987	1.07	1.14	1.40	1.61	1.80	2.21
30-DC-07	0.760	0.931	1.07	1.20	1.32	1.42	1.52	1.86	2.15	2.40	2.94
30-DC-08	0.960	1.18	1.36	1.52	1.66	1.80	1.92	2.35	2.72	3.04	3.72
30-DC-10	1.55	1.90	2.19	2.45	2.68	2.90	3.10	3.80	4.38	4.90	6.00
30-DC-12	2.20	2.69	3.11	3.48	3.81	4.12	4.40	5.39	6.22	6.96	8.52

METRIC UNITS

Disc	Flow L/min Pressure (BAR)									
	1	2	3	4	5	6	7	8	9	10
30-DC010	0.037	0.052	0.064	0.074	0.083	0.091	0.098	0.105	0.111	0.117
30-DC-018	0.14	0.20	0.24	0.28	0.31	0.34	0.37	0.39	0.42	0.44
30-DC-023	0.18	0.25	0.31	0.36	0.40	0.44	0.47	0.51	0.54	0.57
30-DC-01	0.26	0.37	0.45	0.52	0.58	0.64	0.69	0.73	0.78	0.82
30-DC-015	0.36	0.51	0.62	0.72	0.80	0.88	0.95	1.01	1.07	1.13
30-DC-02	0.48	0.68	0.83	0.96	1.07	1.17	1.27	1.36	1.44	1.52
30-DC-03	0.61	0.86	1.05	1.21	1.36	1.48	1.60	1.71	1.82	1.92
30-DC-04	1.10	1.56	1.91	2.21	2.47	2.70	2.92	3.12	3.31	3.49
30-DC-05	1.79	2.53	3.10	3.58	4.00	4.38	4.74	5.06	5.37	5.66
30-DC-06	2.61	3.69	4.52	5.22	5.84	6.39	6.90	7.38	7.83	8.25
30-DC-07	3.49	4.94	6.05	6.99	7.81	8.56	9.24	9.88	10.48	11.05
30-DC-08	4.39	6.21	7.60	8.78	9.81	10.75	11.61	12.41	13.16	13.88
30-DC-10	7.35	10.39	12.73	14.70	16.43	18.00	19.45	20.79	22.05	23.24
30-DC-12	9.93	14.04	17.20	19.86	22.21	24.32	26.27	28.09	29.79	31.40

Features	
Common Use	Fertilizer
Pattern	Stream
Technology	Round Orifice
Material	Polyacetal
Spray Angle	0°
Pressure Range	10-150 PSI (1-10 BAR)
Configuration	Disc

Part Numbers	
Nozzles	Nozzles (10 per bag)
30-DC-00	10BG-30-DC-00
30-DC010	10BG-30-DC010
30-D C018	10BG-30-DC018
30-DC023	10BG-30-DC023
30-DC-01	10BG-30-DC-01
30-DC-015	10BG-30-DC-015
30-DC-02	10BG-30-DC-02
30-DC-03	10BG-30-DC-03
30-DC-035	10BG-30-DC-035
30-DC-04	10BG-30-DC-04
30-DC-05	10BG-30-DC-05
30-DC-06	10BG-30-DC-06
30-DC-07	10BG-30-DC-07
30-DC-08	10BG-30-DC-08
30-DC-10	10BG-30-DC-10
30-DC-12	10BG-30-DC-12

Split Gasket (10 per bag)
10BG-1700-0255

FLOW REGULATING DISC AMT 0°

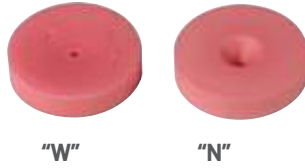

The Albus® ceramic disc regulates flow and produces a straight stream pattern.

- ◆ Precision-molded in ceramic
- ◆ Flexibility of flow rate is achieved through changing disc orientation

US UNITS

Disc	US Gallon/Min													
	PSI													
	10	15	20	25	30	35	40	60	80	100	150	200	300	725
AMT-15007 (N)	0.063	0.077	0.088	0.099	0.108	0.117	0.125	0.153	0.177	0.198	0.242	0.280	0.342	0.532
AMT-15007 (W)	0.064	0.078	0.091	0.101	0.111	0.120	0.128	0.157	0.181	0.202	0.248	0.286	0.351	0.545
AMT-15008 (N)	0.066	0.080	0.093	0.104	0.113	0.123	0.131	0.160	0.185	0.207	0.254	0.293	0.359	0.558
AMT-15008 (W)	0.083	0.101	0.117	0.130	0.143	0.154	0.165	0.202	0.233	0.261	0.320	0.369	0.452	0.702
AMT-15010 (N)	0.099	0.121	0.140	0.157	0.171	0.185	0.198	0.242	0.280	0.313	0.383	0.443	0.542	0.843
AMT-15010 (W)	0.139	0.170	0.197	0.220	0.241	0.260	0.278	0.340	0.393	0.440	0.538	0.622	0.761	1.18
AMT-15012 (N)	0.144	0.176	0.203	0.227	0.249	0.268	0.287	0.352	0.406	0.454	0.556	0.642	0.786	1.22
AMT-15012 (W)	0.174	0.213	0.246	0.275	0.301	0.326	0.348	0.426	0.492	0.550	0.674	0.778	0.953	1.48
AMT-15015 (N)	0.217	0.265	0.306	0.342	0.375	0.405	0.433	0.530	0.612	0.685	0.839	0.968	1.19	1.84
AMT-15015 (W)	0.287	0.351	0.405	0.453	0.496	0.536	0.573	0.702	0.810	0.906	1.11	1.28	1.57	2.44
AMT-15018 (N)	0.302	0.370	0.427	0.478	0.523	0.565	0.604	0.740	0.854	0.955	1.17	1.35	1.65	2.57
AMT-15020 (N)	0.375	0.459	0.530	0.593	0.650	0.702	0.750	0.919	1.06	1.19	1.45	1.68	2.05	3.19
AMT-15018 (W)	0.388	0.475	0.548	0.613	0.671	0.725	0.775	0.949	1.10	1.23	1.50	1.73	2.12	3.30
AMT-15020 (W)	0.472	0.577	0.667	0.746	0.817	0.882	0.943	1.15	1.33	1.49	1.83	2.11	2.58	4.01
AMT-15023 (N)	0.485	0.594	0.686	0.767	0.840	0.907	0.970	1.19	1.37	1.53	1.88	2.17	2.66	4.13
AMT-15023 (W)	0.605	0.741	0.856	0.957	1.05	1.13	1.21	1.48	1.71	1.91	2.34	2.71	3.31	5.15

Features	
Common Use	Fertilizer
Pattern	Stream
Technology	Round Orifice
Material	Ceramic
Spray Angle	0°
Pressure Range	10-725 PSI (1-50 BAR)
Configuration	Disc

Part Numbers	
Nozzles	

AMT-15007
AMT-15008
AMT-15010
AMT-15012
AMT-15015
AMT-15018
AMT-15020
AMT-15023

W - Numbers can be read on face of disc when installed in cap
 N - Numbers on disc cannot be read when installed in cap
 Photos above show the disc exit side.

METRIC UNITS

Disc	Liters/Min													
	BAR													
	0.7	1.0	1.4	1.7	2.1	2.4	2.8	4.1	5.5	6.9	10.3	13.8	20.7	50.0
AMT-15007 (N)	0.238	0.291	0.333	0.375	0.409	0.443	0.473	0.579	0.670	0.750	0.916	1.060	1.295	2.014
AMT-15007 (W)	0.242	0.295	0.344	0.382	0.420	0.454	0.485	0.594	0.685	0.765	0.939	1.083	1.329	2.063
AMT-15008 (N)	0.250	0.303	0.352	0.394	0.428	0.466	0.496	0.606	0.700	0.784	0.961	1.109	1.359	2.112
AMT-15008 (W)	0.314	0.382	0.443	0.492	0.541	0.583	0.625	0.765	0.882	0.988	1.211	1.397	1.711	2.657
AMT-15010 (N)	0.375	0.458	0.530	0.594	0.647	0.700	0.750	0.916	1.060	1.185	1.450	1.677	2.052	3.191
AMT-15010 (W)	0.526	0.644	0.746	0.833	0.912	0.984	1.052	1.287	1.488	1.666	2.037	2.355	2.881	4.467
AMT-15012 (N)	0.545	0.666	0.768	0.859	0.943	1.014	1.086	1.332	1.537	1.719	2.105	2.430	2.975	4.618
AMT-15012 (W)	0.659	0.806	0.931	1.041	1.139	1.234	1.317	1.613	1.862	2.082	2.551	2.945	3.607	5.602
AMT-15015 (N)	0.821	1.003	1.158	1.295	1.420	1.533	1.639	2.006	2.317	2.593	3.176	3.664	4.505	6.965
AMT-15015 (W)	1.086	1.329	1.533	1.715	1.878	2.029	2.169	2.657	3.066	3.430	4.202	4.845	5.943	9.236
AMT-15018 (N)	1.143	1.401	1.616	1.809	1.980	2.139	2.286	2.801	3.233	3.615	4.429	5.110	6.246	9.729
AMT-15020 (N)	1.420	1.738	2.006	2.245	2.461	2.657	2.839	3.479	4.013	4.505	5.489	6.359	7.760	12.075
AMT-15018 (W)	1.469	1.798	2.074	2.320	2.540	2.744	2.934	3.592	4.164	4.656	5.678	6.549	8.025	12.492
AMT-15020 (W)	1.787	2.184	2.525	2.824	3.093	3.339	3.570	4.353	5.035	5.640	6.927	7.987	9.766	15.180
AMT-15023 (N)	1.836	2.249	2.597	2.903	3.180	3.433	3.672	4.505	5.186	5.792	7.117	8.214	10.069	15.634
AMT-15023 (W)	2.290	2.805	3.240	3.623	3.975	4.278	4.580	5.602	6.473	7.230	8.858	10.258	12.530	19.495

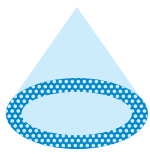

HOLLOW CONE - SWIRLTIP DISC & CORES 25°-110°



DISC



CORE

The Hypro SwirlTip disc and core hollow-cone spray nozzles produce finely atomized droplets.

- ◆ Hollow cone pattern in a variety of spray pattern widths
- ◆ Discs conveniently packaged in a quantity of ten

US UNITS

Disc	Core	Spray Angle at 40 PSI	Color Disc/Core	US Gallon/Min							
				PSI							
				10	20	30	40	60	80	100	150
30-DC-01	30-CR-13	50	Gray/Red	-	-	0.06	0.07	0.08	0.09	0.10	0.13
30-DC-015	30-CR-13	55	Black/Red	-	-	0.06	0.07	0.09	0.10	0.11	0.14
30-DC-02	30-CR-13	65	Brown/Red	-	0.06	0.07	0.08	0.10	0.12	0.13	0.16
30-DC-03	30-CR-13	70	Orange/Red	-	0.06	0.08	0.09	0.11	0.12	0.14	0.17
30-DC-04	30-CR-13	80	Red/Red	0.06	0.08	0.10	0.12	0.14	0.17	0.19	0.23
30-DC-01	30-CR-23	45	Gray/LightBlue	-	-	0.06	0.07	0.09	0.10	0.11	0.14
30-DC-015	30-CR-23	50	Black/LightBlue	-	-	0.07	0.09	0.10	0.12	0.13	0.16
30-DC-02	30-CR-23	70	Brown/LightBlue	-	0.08	0.09	0.11	0.13	0.15	0.17	0.21
30-DC-03	30-CR-23	70	Orange/LightBlue	0.06	0.08	0.10	0.12	0.14	0.16	0.18	0.22
30-DC-04	30-CR-23	80	Red/LightBlue	0.08	0.11	0.13	0.15	0.19	0.22	0.24	0.30
30-DC-05	30-CR-23	90	Blue/LightBlue	0.09	0.13	0.16	0.18	0.22	0.25	0.28	0.35
30-DC-06	30-CR-23	90	Yellow/LightBlue	0.10	0.15	0.18	0.21	0.25	0.29	0.33	0.40
30-DC-01	30-CR-25	25	Gray/Yellow	-	-	0.09	0.10	0.12	0.14	0.16	0.19
30-DC-015	30-CR-25	40	Black/Yellow	-	-	0.11	0.13	0.16	0.19	0.21	0.26
30-DC-02	30-CR-25	50	Brown/Yellow	-	0.11	0.13	0.16	0.19	0.22	0.25	0.30
30-DC-03	30-CR-25	60	Orange/Yellow	0.09	0.13	0.16	0.19	0.23	0.27	0.30	0.36
30-DC-04	30-CR-25	75	Red/Yellow	0.14	0.19	0.24	0.28	0.34	0.39	0.43	0.53
30-DC-05	30-CR-25	80	Blue/Yellow	0.18	0.25	0.30	0.35	0.43	0.49	0.55	0.68
30-DC-06	30-CR-25	85	Yellow/Yellow	0.23	0.32	0.39	0.45	0.55	0.64	0.71	0.87
30-DC-07	30-CR-25	90	Green/Yellow	0.25	0.35	0.43	0.50	0.61	0.71	0.79	0.97
30-DC-08	30-CR-25	95	White/Yellow	0.30	0.42	0.52	0.60	0.73	0.85	0.95	1.16
30-DC-10	30-CR-25	100	LimeGreen/Yellow	0.38	0.53	0.65	0.75	0.92	1.06	1.19	1.45
30-DC-12	30-CR-25	110	RoyalBlue/Yellow	0.46	0.65	0.80	0.93	1.13	1.31	1.46	1.79
30-DC-01	30-CR-45	25	Gray/Green	-	-	-	0.12	0.15	0.17	0.19	0.23
30-DC-015	30-CR-45	35	Black/Green	-	-	0.14	0.16	0.20	0.23	0.25	0.31
30-DC-02	30-CR-45	45	Brown/Green	-	0.14	0.17	0.20	0.24	0.28	0.32	0.39
30-DC-03	30-CR-45	55	Orange/Green	-	0.16	0.20	0.23	0.28	0.32	0.36	0.44
30-DC-04	30-CR-45	70	Red/Green	0.18	0.25	0.30	0.35	0.43	0.49	0.55	0.68
30-DC-05	30-CR-45	75	Blue/Green	0.23	0.32	0.39	0.45	0.55	0.64	0.71	0.87
30-DC-06	30-CR-45	80	Yellow/Green	0.29	0.41	0.50	0.58	0.70	0.81	0.91	1.11
30-DC-07	30-CR-45	85	Green/Green	0.34	0.48	0.58	0.68	0.83	0.95	1.07	1.31
30-DC-08	30-CR-45	90	White/Green	0.41	0.58	0.71	0.83	1.01	1.17	1.30	1.60
30-DC-10	30-CR-45	95	LimeGreen/Green	0.55	0.78	0.95	1.10	1.35	1.56	1.74	2.13
30-DC-12	30-CR-45	100	RoyalBlue/Green	0.67	0.95	1.16	1.34	1.64	1.90	2.12	2.60

DC/CR DISC CORE

	40 PSI	50 PSI	60 PSI	70 PSI	80 PSI	90 PSI	100 PSI	125 PSI	150 PSI
30-DC-01/30-CR-23	F	F	VF	VF	VF	VF	VF	VF	VF
30-DC-015/30-CR-23	F	F	VF	VF	VF	VF	VF	VF	VF
30-DC-02/30-CR-23	F	F	F	VF	VF	VF	VF	VF	VF
30-DC-03/30-CR-23	F	F	F	F	VF	VF	VF	VF	VF
30-DC-04/30-CR-23	F	F	F	F	F	F	VF	VF	VF
30-DC-05/30-CR-23	F	F	F	F	F	F	F	VF	VF
30-DC-06/30-CR-23	M	F	F	F	F	F	F	F	VF
30-DC-01/30-CR-25	F	F	F	VF	VF	VF	VF	VF	VF
30-DC-015/30-CR-25	F	F	F	F	VF	VF	VF	VF	VF
30-DC-02/30-CR-25	F	F	F	F	VF	VF	VF	VF	VF
30-DC-03/30-CR-25	F	F	F	F	F	VF	VF	VF	VF
30-DC-04/30-CR-25	M	F	F	F	F	F	F	VF	VF
30-DC-05/30-CR-25	M	M	M	F	F	F	F	VF	VF
30-DC-06/30-CR-25	M	M	M	M	M	M	F	F	F
30-DC-07/30-CR-25	M	M	M	M	M	M	M	F	F
30-DC-08/30-CR-25	C	C	C	C	M	M	M	M	M
30-DC-10/30-CR-25	C	C	C	C	C	M	M	M	M
30-DC-01/30-CR-45	F	F	F	VF	VF	VF	VF	VF	VF
30-DC-015/30-CR-45	M	F	F	F	VF	VF	VF	VF	VF
30-DC-02/30-CR-45	M	M	F	F	F	VF	VF	VF	VF
30-DC-03/30-CR-45	M	M	M	F	F	F	VF	VF	VF
30-DC-04/30-CR-45	M	M	M	M	F	F	F	VF	VF
30-DC-05/30-CR-45	M	M	M	M	M	F	F	F	VF
30-DC-06/30-CR-45	C	M	M	M	M	M	M	F	F
30-DC-07/30-CR-45	C	C	M	M	M	M	M	M	F
30-DC-081/30-CR-45	C	C	C	M	M	M	M	M	M

Droplet size based on ASABE S572.1 standard.

HOLLOW CONE - SWIRLTIP DISC & CORES 25°-110°



METRIC UNITS

Disc	Core	Spray Angle at 2,75 BAR	Color Disc/Core	Flow L/min							
				Pressure BAR							
				1	2	3	4	5	6	8	10
30-DC-01	30-CR-13	50	Gray/Red	0,16	0,22	0,27	0,31	0,35	0,38	0,44	0,49
30-DC-015	30-CR-13	55	Black/Red	0,17	0,24	0,29	0,33	0,37	0,41	0,47	0,53
30-DC-02	30-CR-13	65	Brown/Red	0,18	0,26	0,32	0,37	0,41	0,45	0,52	0,58
30-DC-03	30-CR-13	70	Orange/Red	0,21	0,29	0,36	0,42	0,46	0,51	0,59	0,66
30-DC-04	30-CR-13	80	Red/Red	0,27	0,38	0,47	0,54	0,61	0,66	0,77	0,86
30-DC-01	30-CR-23	45	Gray/LightBlue	0,16	0,23	0,28	0,32	0,36	0,40	0,46	0,51
30-DC-015	30-CR-23	50	Black/LightBlue	0,21	0,29	0,36	0,42	0,46	0,51	0,59	0,66
30-DC-02	30-CR-23	70	Brown/LightBlue	0,23	0,32	0,39	0,45	0,50	0,55	0,64	0,71
30-DC-03	30-CR-23	70	Orange/LightBlue	0,27	0,38	0,47	0,54	0,61	0,66	0,77	0,86
30-DC-04	30-CR-23	80	Red/LightBlue	0,34	0,48	0,59	0,68	0,76	0,83	0,96	1,08
30-DC-05	30-CR-23	90	Blue/LightBlue	0,41	0,58	0,71	0,82	0,92	1,00	1,16	1,30
30-DC-06	30-CR-23	90	Yellow/LightBlue	0,48	0,68	0,83	0,96	1,07	1,17	1,36	1,52
30-DC-01	30-CR-25	25	Gray/Yellow	0,23	0,33	0,40	0,46	0,52	0,57	0,65	0,73
30-DC-015	30-CR-25	40	Black/Yellow	0,30	0,42	0,52	0,60	0,67	0,74	0,85	0,95
30-DC-02	30-CR-25	50	Brown/Yellow	0,36	0,51	0,63	0,73	0,81	0,89	1,03	1,15
30-DC-03	30-CR-25	60	Orange/Yellow	0,43	0,61	0,75	0,87	0,97	1,06	1,22	1,37
30-DC-04	30-CR-25	75	Red/Yellow	0,66	0,93	1,14	1,32	1,47	1,61	1,86	2,08
30-DC-05	30-CR-25	80	Blue/Yellow	0,80	1,13	1,38	1,59	1,78	1,95	2,25	2,52
30-DC-06	30-CR-25	85	Yellow/Yellow	1,00	1,42	1,74	2,01	2,25	2,46	2,84	3,18
30-DC-07	30-CR-25	90	Green/Yellow	1,18	1,67	2,05	2,37	2,65	2,90	3,35	3,74
30-DC-08	30-CR-25	95	White/Yellow	1,39	1,97	2,41	2,78	3,11	3,41	3,94	4,40
30-DC-10	30-CR-25	100	LimeGreen/Yellow	1,73	2,45	3,00	3,46	3,87	4,24	4,90	5,48
30-DC-12	30-CR-25	110	RoyalBlue/Yellow	2,12	3,00	3,67	4,24	4,74	5,19	5,99	6,70
30-DC-01	30-CR-45	25	Gray/Green	0,28	0,39	0,48	0,55	0,62	0,68	0,78	0,88
30-DC-015	30-CR-45	35	Black/Green	0,37	0,52	0,64	0,74	0,83	0,91	1,05	1,17
30-DC-02	30-CR-45	45	Brown/Green	0,46	0,65	0,80	0,92	1,03	1,13	1,31	1,46
30-DC-03	30-CR-45	55	Orange/Green	0,53	0,74	0,91	1,05	1,17	1,29	1,49	1,66
30-DC-04	30-CR-45	70	Red/Green	0,82	1,16	1,42	1,64	1,83	2,01	2,32	2,59
30-DC-05	30-CR-45	75	Blue/Green	1,03	1,45	1,78	2,06	2,30	2,52	2,91	3,25
30-DC-06	30-CR-45	80	Yellow/Green	1,32	1,87	2,29	2,64	2,96	3,24	3,74	4,18
30-DC-07	30-CR-45	85	Green/Green	1,55	2,19	2,68	3,09	3,46	3,79	4,38	4,89
30-DC-08	30-CR-45	90	White/Green	1,92	2,71	3,32	3,83	4,29	4,70	5,42	6,06
30-DC-10	30-CR-45	95	LimeGreen/Green	2,54	3,59	4,40	5,08	5,68	6,22	7,19	8,03
30-DC-12	30-CR-45	100	RoyalBlue/Green	3,10	4,38	5,37	6,20	6,93	7,59	8,77	9,80

Features		
Common Use	Plant Health	
Pattern	Hollow Cone	
Technology	Swirl	
Material	Polyacetal	
Spray Angle	25° - 110°	
Pressure Range	10-150 PSI (1-10 BAR)	
Configuration	Nozzle	
Part Numbers		
Discs	Discs (10 per Bag)	Cores
30-DC-01	10BG-30-DC-01	30-CR-13
30-DC-015	10BG-30-DC-015	30-CR-23
30-DC-02	10BG-30-DC-02	30-CR-25
30-DC-03	10BG-30-DC-03	30-CR-45
30-DC-04	10BG-30-DC-04	-
30-DC-05	10BG-30-DC-05	-
30-DC-06	10BG-30-DC-06	-
30-DC-07	10BG-30-DC-07	-
30-DC-08	10BG-30-DC-08	-
30-DC-10	10BG-30-DC-10	-
30-DC-12	10BG-30-DC-12	-

DC/CR DISC CORE

	2.5 BAR	3 BAR	3.5 BAR	4 BAR	4.5 BAR	5 BAR	5.5 BAR	6 BAR
30-DC-01/30-CR-23	F	F	F	VF	VF	VF	VF	VF
30-DC-02/30-CR-23	F	F	F	F	VF	VF	VF	VF
30-DC-03/30-CR-23	F	F	F	F	F	F	VF	VF
30-DC-04/30-CR-23	F	F	F	F	F	F	F	F
30-DC-05/30-CR-23	M	F	F	F	F	F	F	F
30-DC-06/30-CR-23	M	M	F	F	F	F	F	F
30-DC-01/30-CR-25	F	F	F	F	VF	VF	VF	VF
30-DC-015/30-CR-25	F	F	F	F	F	VF	VF	VF
30-DC-02/30-CR-25	F	F	F	F	F	F	VF	VF
30-DC-03/30-CR-25	M	F	F	F	F	F	F	VF
30-DC-04/30-CR-25	M	M	F	F	F	F	F	F
30-DC-05/30-CR-25	M	M	M	M	M	M	F	F
30-DC-06/30-CR-25	M	M	M	M	M	M	M	M
30-DC-07/30-CR-25	M	M	M	M	M	M	M	M
30-DC-08/30-CR-25	C	C	C	C	C	C	M	M
30-DC-10/30-CR-25	C	C	C	C	C	C	C	M
30-DC-01/30-CR-45	M	F	F	F	F	VF	VF	VF
30-DC-015/30-CR-45	M	M	F	F	F	F	VF	VF
30-DC-02/30-CR-45	M	M	M	F	F	F	F	VF
30-DC-03/30-CR-45	M	M	M	M	F	F	F	F
30-DC-04/30-CR-45	M	M	M	M	M	M	M	F
30-DC-05/30-CR-45	M	M	M	M	M	M	M	M
30-DC-06/30-CR-45	C	M	M	M	M	M	M	F
30-DC-07/30-CR-45	C	C	C	M	M	M	M	M
30-DC-08/30-CR-45	C	C	C	C	M	M	M	M

Droplet size based on ASABE S572.1 standard.

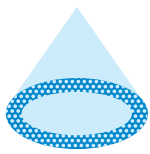

HOLLOW CONE - CERAMIC DISC & CORES 13° - 93°



Albuz® ceramic discs and cores are the longest lasting disc-core nozzles, making them ideal for abrasive agricultural and horticultural sprays. DCC/CRC nozzles will outlast stainless steel disc-core nozzles by up to 10 times and perform superbly at high pressures, common on many air-blast and directed sprayers.

US UNITS

DISC	Hollow Cone CORE	Flow Rate GPM										Spray Angle Degrees		
		Pressure (PSI)										Pressure (PSI)		
		10	20	30	40	60	80	100	150	200	300	20	40	80
DCC-01	CRC-13	-	-	0.059	0.066	0.078	0.088	0.097	0.115	0.128	0.152	-	51	62
DCC-02	CRC-13	-	0.064	0.075	0.08	0.10	0.11	0.12	0.14	0.16	0.18	49	67	72
DCC-03	CRC-13	-	0.071	0.08	0.09	0.11	0.12	0.13	0.16	0.18	0.20	53	70	75
DCC-04	CRC-13	0.07	0.09	0.11	0.12	0.14	0.16	0.17	0.20	0.23	0.27	69	79	83
DCC-01	CRC-23	-	-	0.064	0.072	0.080	0.096	0.107	0.124	0.139	0.164	-	47	58
DCC-02	CRC-23	-	0.078	0.092	0.10	0.13	0.14	0.16	0.19	0.21	0.25	51	63	70
DCC-03	CRC-23	0.065	0.087	0.10	0.12	0.14	0.16	0.18	0.21	0.24	0.28	58	69	75
DCC-04	CRC-23	0.082	0.113	0.14	0.15	0.19	0.21	0.23	0.28	0.32	0.38	68	82	87
DCC-05	CRC-23	0.095	0.13	0.16	0.18	0.22	0.25	0.28	0.34	0.38	0.46	79	89	94
DCC-06	CRC-23	0.112	0.15	0.19	0.21	0.26	0.29	0.32	0.39	0.45	0.54	84	93	98
DCC-01	CRC-25	-	-	0.088	0.101	0.122	0.138	0.156	0.185	0.210	0.255	-	27	43
DCC-02	CRC-25	-	0.12	0.14	0.16	0.19	0.22	0.25	0.29	0.34	0.41	39	51	58
DCC-03	CRC-25	0.10	0.14	0.17	0.19	0.23	0.26	0.29	0.35	0.40	0.48	52	61	67
DCC-04	CRC-25	0.15	0.21	0.25	0.29	0.35	0.40	0.45	0.54	0.62	0.75	67	74	80
DCC-05	CRC-25	0.18	0.25	0.30	0.35	0.42	0.48	0.54	0.65	0.75	0.90	73	79	84
DCC-06	CRC-25	0.23	0.32	0.39	0.44	0.54	0.62	0.70	0.85	0.97	1.19	79	85	89
DCC-07	CRC-25	0.26	0.37	0.45	0.52	0.63	0.73	0.81	0.98	1.18	1.37	85	91	93
DCC-01	CRC-45	-	-	-	0.125	0.148	0.170	0.190	0.225	0.257	0.310	-	22	34
DCC-02	CRC-45	-	0.14	0.18	0.20	0.25	0.28	0.32	0.38	0.44	0.53	32	46	55
DCC-03	CRC-45	-	0.17	0.20	0.23	0.28	0.33	0.36	0.44	0.51	0.62	40	53	60
DCC-04	CRC-45	0.18	0.25	0.31	0.36	0.43	0.50	0.56	0.68	0.78	0.95	62	69	72
DCC-05	CRC-45	0.23	0.32	0.39	0.45	0.55	0.64	0.71	0.86	0.99	1.22	67	73	76
DCC-06	CRC-45	0.29	0.41	0.50	0.58	0.72	0.83	0.93	1.15	1.33	1.64	73	79	81
DCC-07	CRC-45	0.33	0.48	0.59	0.68	0.84	0.97	1.11	1.4	1.57	1.94	81	86	87
DCC-01	CRC-46	-	-	-	0.145	0.178	0.205	0.23	0.28	0.32	0.39	-	13	15
DCC-02	CRC-46	-	-	0.24	0.27	0.33	0.37	0.42	0.50	0.57	0.68	-	18	21
DCC-03	CRC-46	-	0.23	0.28	0.32	0.39	0.45	0.51	0.61	0.70	0.86	14	20	24
DCC-04	CRC-46	0.28	0.39	0.48	0.56	0.68	0.78	0.88	1.07	1.23	1.52	23	29	33
DCC-05	CRC-46	0.38	0.54	0.66	0.77	0.94	1.10	1.25	1.50	1.73	2.13	33	39	42
DCC-06	CRC-46	0.55	0.78	0.95	1.10	1.35	1.58	1.73	2.16	2.50	3.06	42	48	50
DCC-07	CRC-46	-	0.98	1.22	1.39	1.72	1.97	2.22	2.73	3.15	3.85	48	53	56



METRIC UNITS

DISC	Hollow Cone CORE	Flow Rate, LPM							Spray Angle Degrees	
		Pressure (BAR)							Pressure (BAR)	
		3	4	5	6	10	15	20	10	20
DCC-01	CRC-13	0.280	0.290	0.320	0.340	0.430	0.510	0.570	66	68
DCC-02	CRC-13	0.320	0.370	0.400	0.42	0.52	0.63	0.67	74	75
DCC-03	CRC-13	0.360	0.410	0.43	0.48	0.60	0.71	0.74	77	78
DCC-04	CRC-13	0.47	0.52	0.58	0.60	0.74	0.91	1.00	84	85
DCC-01	CRC-23	0.280	0.300	0.350	0.380	0.480	0.550	0.610	63	65
DCC-02	CRC-23	0.390	0.480	0.500	0.56	0.71	0.83	0.93	72	72
DCC-03	CRC-23	0.470	0.520	0.58	0.64	0.78	0.95	1.04	77	77
DCC-04	CRC-23	0.590	0.710	0.76	0.81	1.04	1.26	1.41	88	87
DCC-05	CRC-23	0.710	0.82	0.90	0.99	1.27	1.50	1.71	96	95
DCC-06	CRC-23	0.830	0.97	1.04	1.13	1.45	1.78	2.01	100	99
DCC-01	CRC-25	0.400	0.420	0.500	0.550	0.690	0.830	0.950	49	51
DCC-02	CRC-25	0.63	0.71	0.79	0.88	1.08	1.34	1.53	61	61
DCC-03	CRC-25	0.75	0.86	0.94	1.02	1.30	1.58	1.79	69	69
DCC-04	CRC-25	1.14	1.30	1.44	1.59	2.01	2.45	2.79	82	82
DCC-05	CRC-25	1.36	1.56	1.73	1.91	2.42	2.96	3.35	85	84
DCC-06	CRC-25	1.74	2.01	2.23	2.47	3.16	3.83	4.43	89	88
DCC-07	CRC-25	2.05	2.34	2.63	2.86	3.85	4.66	5.10	92	91
DCC-01	CRC-45	0.490	0.550	0.610	0.670	0.840	1.010	1.150	39	40
DCC-02	CRC-45	0.79	0.93	1.01	1.13	1.41	1.74	1.97	58	58
DCC-03	CRC-45	0.91	1.04	1.19	1.27	1.84	2.01	2.31	62	62
DCC-04	CRC-45	1.42	1.60	1.80	1.98	2.53	3.08	3.54	73	72
DCC-05	CRC-45	1.78	2.05	2.31	2.51	3.20	3.91	4.54	76	75
DCC-06	CRC-45	2.29	2.68	2.99	3.28	4.28	5.25	6.10	80	79
DCC-07	CRC-45	2.68	3.13	3.50	3.92	5.02	6.20	7.22	86	85
DCC-01	CRC-46	0.570	0.660	0.740	0.810	1.040	1.260	1.45	17	17
DCC-02	CRC-46	1.07	1.23	1.33	1.48	1.86	2.25	2.53	20	18
DCC-03	CRC-46	1.26	1.45	1.62	1.80	2.27	2.76	3.20	23	21
DCC-04	CRC-46	2.21	2.53	2.81	3.11	3.98	4.85	5.86	32	31
DCC-05	CRC-46	3.04	3.50	3.96	4.41	5.58	6.83	7.93	41	40
DCC-06	CRC-46	4.34	5.02	5.69	6.11	8.04	9.87	11.39	49	47
DCC-07	CRC-46	5.49	6.40	7.10	7.84	10.16	12.43	14.33	55	53

Features		
Common Use	Plant Health	
Pattern	Hollow Cone	
Technology	Swirl	
Material	Ceramic	
Spray Angle	13°-93°	
Pressure Range	10-300 PSI (1-20 BAR)	
Configuration	Nozzle	
Part Numbers		
Discs	Cores	Caps (25 Pack)
DCC-01	CRC-13	CAP05-20
DCC-02	CRC-23	CAP05-20
DCC-03	CRC-45	CAP05-20
DCC-04	CRC-46	CAP05-20
DCC-05	-	CAP05-20
DCC-06	-	CAP05-20
DCC-07	-	CAP05-20

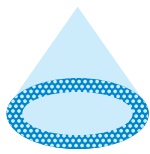

HOLLOW CONE - HCX 80°



The Hypro Hollow-Cone spray nozzles are excellent for fungicide and insecticide application. The HCX produces finely atomized droplets in a hollow-cone, 80-degree pattern.

- ◆ Precision-molded in polyacetal for durable product life
- ◆ Wide operating pressure

US UNITS

Spray Nozzle	Flow Rate GPM											
	Pressure (PSI)											
	40	50	60	70	80	90	100	110	120	130	140	150
30HCX2	0.030	0.034	0.037	0.040	0.042	0.045	0.047	0.050	0.052	0.054	0.056	0.058
30HCX3	0.050	0.056	0.061	0.066	0.071	0.075	0.079	0.083	0.087	0.090	0.094	0.097
30HCX4	0.070	0.078	0.086	0.093	0.099	0.105	0.111	0.116	0.121	0.126	0.131	0.136
30HCX6	0.102	0.114	0.125	0.135	0.144	0.153	0.161	0.169	0.177	0.184	0.191	0.198
30HCX8	0.133	0.149	0.163	0.176	0.188	0.200	0.210	0.221	0.230	0.240	0.249	0.258
30HCX9	0.148	0.165	0.181	0.196	0.209	0.222	0.234	0.245	0.256	0.267	0.277	0.287
30HCX10	0.164	0.183	0.201	0.217	0.232	0.246	0.259	0.272	0.284	0.296	0.307	0.318
30HCX12	0.203	0.227	0.249	0.269	0.287	0.305	0.321	0.337	0.352	0.366	0.380	0.393
30HCX18	0.300	0.335	0.367	0.397	0.424	0.450	0.474	0.497	0.520	0.541	0.561	0.581

Features	
Common Use	Plant Health
Pattern	Hollow Cone
Technology	Swirl
Material	Polyacetal
Spray Angle	80°
Pressure Range	40-150 PSI (3-10 BAR)
Configuration	Nozzle

HCX80° - HOLLOW CONE

	40 PSI	50 PSI	60 PSI	70 PSI	80 PSI	90 PSI	100 PSI	125 PSI	150 PSI
30HCX2	F	F	F	F	VF	VF	VF	VF	VF
30HCX3	F	F	F	F	F	F	F	VF	VF
30HCX4	F	F	F	F	F	F	F	F	VF
30HCX6	M	F	F	F	F	F	F	F	F
30HCX8	F	VF	VF	VF	VF	VF	VF	VF	VF
30HCX9	F	F	F	VF	VF	VF	VF	VF	VF
30HCX10	F	F	VF	VF	VF	VF	VF	VF	VF
30HCX12	F	F	F	VF	VF	VF	VF	VF	VF
30HCX18	F	F	F	F	F	F	F	VF	VF

Droplet size based on ASABE S572.1 standard.

Part Numbers (Bags of 10)

Nozzles 80°	Caps (25 Pack)
30HCX2	CAP04-20
30HCX3	CAP04-20
30HCX4	CAP04-20
30HCX6	CAP04-20
30HCX8	CAP04-20
30HCX9	CAP04-20
30HCX10	CAP04-20
30HCX12	CAP04-20
30HCX18	CAP04-20

METRIC UNITS

Spray Nozzle	Flow Rate L/min											
	Pressure (BAR)											
	3	3,5	4	4,5	5	5,5	6	6,5	7	8	9	10
30HCX2	0,132	0,143	0,152	0,162	0,170	0,179	0,187	0,194	0,202	0,216	0,229	0,241
30HCX3	0,199	0,215	0,230	0,244	0,257	0,269	0,281	0,293	0,304	0,325	0,345	0,363
30HCX4	0,265	0,286	0,306	0,325	0,342	0,359	0,375	0,390	0,405	0,433	0,459	0,484
30HCX6	0,397	0,429	0,458	0,486	0,513	0,538	0,561	0,584	0,606	0,648	0,688	0,725
30HCX8	0,530	0,572	0,612	0,649	0,684	0,718	0,750	0,780	0,810	0,865	0,918	0,968
30HCX9	0,596	0,644	0,688	0,730	0,769	0,807	0,843	0,877	0,910	0,973	1,032	1,088
30HCX10	0,662	0,715	0,764	0,811	0,855	0,896	0,936	0,974	1,011	1,081	1,147	1,209
30HCX12	0,750	0,810	0,866	0,919	0,968	1,016	1,061	1,104	1,146	1,225	1,299	1,369
30HCX18	1,180	1,275	1,363	1,445	1,523	1,598	1,669	1,737	1,802	1,927	2,044	2,154

HCX80° - HOLLOW CONE

	3 BAR	4 BAR	5 BAR	6 BAR	7 BAR	8 BAR	9 BAR	10 BAR	11 BAR
30HCX2	F	F	F	VF	VF	VF	VF	VF	VF
30HCX3	F	F	F	F	F	VF	VF	VF	VF
30HCX4	F	F	F	F	F	F	VF	VF	VF
30HCX6	M	F	F	F	F	F	F	F	F
30HCX8	F	F	VF	VF	VF	VF	VF	VF	VF
30HCX9	F	F	VF	VF	VF	VF	VF	VF	VF
30HCX10	F	VF	VF	VF	VF	VF	VF	VF	VF
30HCX12	F	F	VF	VF	VF	VF	VF	VF	VF
30HCX18	F	F	F	F	F	VF	VF	VF	VF

Droplet size based on ASABE S572.1 standard.

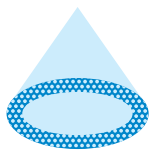

HOLLOW CONE - CERAMIC ATR 80°



The AlbuZ® hollow-cone ceramic spray nozzles produce finely atomized droplets in a hollow-cone, 80-degree pattern.

- ◆ Easily separated, two-piece construction for simple cleaning
- ◆ Wide operating pressure range suitable for many applications
- ◆ Commonly used in airblast and other high pressure spraying applications

US UNITS

Spray Nozzle	Flow Rate GPM												
	Pressure (PSI)												
	40	50	60	70	80	90	100	120	150	200	250	300	350
ATR-WHITE	0.053	0.060	0.065	0.070	0.075	0.079	0.083	0.091	0.101	0.116	0.129	0.141	0.152
ATR-LILAC	0.071	0.079	0.087	0.093	0.099	0.105	0.111	0.121	0.134	0.154	0.171	0.187	0.201
ATR-BROWN	0.095	0.106	0.116	0.125	0.133	0.141	0.148	0.161	0.180	0.206	0.230	0.250	0.270
ATR-YELLOW	0.144	0.161	0.176	0.189	0.202	0.214	0.226	0.247	0.275	0.317	0.354	0.387	0.417
ATR-ORANGE	0.196	0.218	0.239	0.257	0.274	0.290	0.306	0.334	0.372	0.428	0.477	0.521	0.561
ATR-RED	0.275	0.306	0.333	0.359	0.382	0.404	0.425	0.463	0.515	0.591	0.657	0.716	0.771
ATR-GRAY	0.299	0.333	0.362	0.390	0.415	0.439	0.461	0.502	0.558	0.638	0.709	0.773	0.831
ATR-GREEN	0.356	0.395	0.430	0.463	0.493	0.521	0.547	0.596	0.662	0.758	0.842	0.918	0.987
ATR-BLACK	0.399	0.443	0.483	0.520	0.554	0.585	0.615	0.671	0.745	0.854	0.949	1.034	1.113
ATR-BLUE	0.488	0.542	0.591	0.636	0.678	0.716	0.753	0.821	0.913	1.046	1.163	1.268	1.364

Features	
Common Use	Plant Health
Pattern	Hollow Cone
Technology	Swirl
Material	Ceramic
Spray Angle	80°
Pressure Range	40-350 PSI (3-24 BAR)
Configuration	Nozzle

Part Numbers	
ATR 80°	Caps (25 Pack)
ATR-WHITE	CAP05-20
ATR-LILAC	CAP05-20
ATR-BROWN	CAP05-20
ATR-YELLOW	CAP05-20
ATR-ORANGE	CAP05-20
ATR-RED	CAP05-20
ATR-GRAY	CAP05-20
ATR-GREEN	CAP05-20
ATR-BLACK	CAP05-20
ATR-BLUE	CAP05-20

ATR 80° - HOLLOW CONE

	40 PSI	50 PSI	60 PSI	70 PSI	80 PSI	90 PSI	100 PSI	125 PSI	150 PSI	350 PSI
ATR- White	VF	VF	VF	VF	VF	VF	VF	VF	VF	VF
ATR- Lilac	VF	VF	VF	VF	VF	VF	VF	VF	VF	VF
ATR- Brown	VF	VF	VF	VF	VF	VF	VF	VF	VF	VF
ATR- Yellow	F	VF	VF	VF	VF	VF	VF	VF	VF	VF
ATR- Orange	F	F	VF	VF	VF	VF	VF	VF	VF	VF
ATR- Red	F	F	F	F	VF	VF	VF	VF	VF	VF
ATR- Gray	F	F	F	F	F	VF	VF	VF	VF	VF
ATR- Green	F	F	F	F	F	VF	VF	VF	VF	VF
ATR-Black	F	F	F	F	F	F	F	F	VF	VF
ATR- Blue	M	M	M	M	F	F	F	F	F	F

Droplet size based on ASABE S572.1 standard.

METRIC UNITS

Spray Nozzle	Flow Rate LPM																				
	Pressure (BAR)																				
	5	6	7	8	9	10	11	12	13	14	15	16	17	18	19	20	21	22	23	24	25
ATR-WHITE	0.27	0.29	0.32	0.34	0.36	0.38	0.39	0.41	0.43	0.44	0.46	0.47	0.48	0.50	0.51	0.52	0.54	0.55	0.56	0.57	0.58
ATR-LILAC	0.36	0.39	0.42	0.45	0.48	0.50	0.52	0.55	0.57	0.59	0.61	0.63	0.64	0.66	0.68	0.70	0.71	0.73	0.74	0.76	0.77
ATR-BROWN	0.48	0.52	0.56	0.60	0.64	0.67	0.70	0.73	0.76	0.79	0.81	0.84	0.86	0.89	0.91	0.93	0.95	0.98	1.00	1.02	1.04
ATR-YELLOW	0.73	0.80	0.86	0.92	0.97	1.03	1.07	1.12	1.17	1.21	1.25	1.29	1.33	1.37	1.40	1.44	1.48	1.51	1.54	1.58	1.61
ATR-ORANGE	0.99	1.08	1.17	1.24	1.32	1.39	1.45	1.51	1.57	1.63	1.69	1.74	1.79	1.84	1.89	1.94	1.99	2.03	2.07	2.12	2.16
ATR-RED	1.38	1.51	1.62	1.73	1.83	1.92	2.01	2.09	2.17	2.25	2.33	2.40	2.47	2.54	2.60	2.67	2.73	2.79	2.85	2.91	2.97
ATR-GRAY	1.50	1.63	1.76	1.87	1.98	2.08	2.17	2.26	2.35	2.43	2.51	2.59	2.67	2.74	2.81	2.88	2.95	3.01	3.07	3.14	3.20
ATR-GREEN	1.78	1.94	2.09	2.22	2.35	2.47	2.58	2.69	2.79	2.89	2.99	3.08	3.17	3.25	3.34	3.42	3.50	3.57	3.65	3.72	3.80
ATR-BLACK	2.00	2.18	2.35	2.50	2.64	2.80	2.90	3.03	3.14	3.26	3.36	3.47	3.57	3.67	3.76	3.85	3.94	4.03	4.12	4.20	4.28
ATR-BLUE	2.45	2.67	1.87	3.06	3.24	3.40	3.56	3.71	3.85	3.99	4.12	4.25	4.37	4.49	4.61	4.72	4.84	4.94	5.05	5.15	5.25

ATR 80° - HOLLOW CONE

	3 Bar	5 Bar	7 Bar	10 Bar	15 Bar	20 Bar
ATR- White	VF	VF	VF	VF	VF	VF
ATR- Lilac	VF	VF	VF	VF	VF	VF
ATR- Brown	VF	VF	VF	VF	VF	VF
ATR- Yellow	F	VF	VF	VF	VF	VF
ATR- Orange	F	VF	VF	VF	VF	VF
ATR- Red	F	F	VF	VF	VF	VF
ATR- Gray	F	F	F	VF	VF	VF
ATR- Green	F	F	F	VF	VF	VF
ATR-Black	F	F	F	F	VF	VF
ATR- Blue	M	M	F	F	F	F

Droplet size based on ASABE S572.1 standard.

AlbuZ® is a registered trademark of SAINT-GOBAIN SOLCERA, SAINT GOBAIN CERAMIQUES AVANCEES DESMARQUEST, CERAMIQUES TECHNIQUES DESMARQUEST, and SOCIETE DESMARQUEST ET CEC
Hypro® is a registered trademark of Pentair..

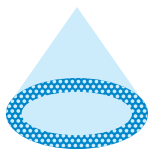

HOLLOW CONE - CERAMIC TVI 80°



The Albus® TVI drastically reduces the potential for spray drift in broadcast, directed, and air-blast applications. The air-induced hollow-cone pattern stays on target, saving chemical and reducing environmental impact.

- ◆ All ceramic orifice creates extremely long life
- ◆ Air-filled droplets control drift and reduce chemical waste

US UNITS

Spray Nozzle	Flow Rate GPM															
	Pressure (PSI)															
	70	80	100	120	140	160	180	200	220	240	260	280	300	320	340	360
TVI-80005	0.066	0.071	0.079	0.087	0.094	0.100	0.106	0.112	0.117	0.122	0.127	0.132	0.137	0.141	0.146	0.150
TVI-800075	0.099	0.106	0.119	0.130	0.140	0.150	0.159	0.168	0.176	0.184	0.191	0.198	0.205	0.212	0.219	0.225
TVI-80015	0.198	0.212	0.237	0.260	0.281	0.300	0.318	0.335	0.352	0.367	0.382	0.397	0.411	0.424	0.437	0.450
TVI-8002	0.265	0.283	0.316	0.346	0.374	0.400	0.424	0.447	0.469	0.490	0.510	0.529	0.548	0.566	0.583	0.600
TVI-80025	0.331	0.354	0.395	0.433	0.468	0.500	0.530	0.559	0.586	0.612	0.637	0.661	0.685	0.707	0.729	0.750
TVI-8003	0.397	0.424	0.474	0.520	0.561	0.600	0.636	0.671	0.704	0.735	0.765	0.794	0.822	0.849	0.875	0.900

TVI 80° - HOLLOW CONE

	70 PSI	150 PSI	200 PSI
TVI-80005	XC	C	C
TVI-800075	XC	C	C
TVI-80015	XC	C	C
TVI-8002	XC	XC	VC
TVI-80025	XC	XC	VC

Droplet size based on ASABE S572.1 standard.

METRIC UNITS

Spray Nozzle	Flow Rate, LPM																				
	Pressure (BAR)																				
	5	6	7	8	9	10	11	12	13	14	15	16	17	18	19	20	21	22	23	24	25
TVI-80005			0.31	0.33	0.35	0.37	0.38	0.40	0.42	0.43	0.45	0.46	0.48	0.49	0.50	0.52	0.53	0.54	0.55	0.57	0.58
TVI-800075	0.39	0.42	0.46	0.49	0.52	0.55	0.57	0.60	0.62	0.65	0.67	0.69	0.71	0.73	0.75	1.03	0.79	0.81	0.83	0.85	0.87
TVI-80015	0.77	0.85	0.92	0.98	1.04	1.10	1.15	1.20	1.25	1.30	1.34	1.39	1.43	1.47	1.51	1.55	1.59	1.62	1.66	1.70	1.73
TVI-8002	1.03	1.13	1.22	1.31	1.39	1.46	1.53	1.60	1.67	1.73	1.79	1.85	1.90	1.96	2.01	2.07	2.12	2.17	2.22	2.26	2.31
TVI-80025	1.03	1.41	1.53	1.63	1.73	1.83	1.91	2.00	2.08	2.16	2.24	2.31	2.38	2.45	2.52	2.58	2.65	2.71	2.77	2.83	2.89
TVI-8003	1.55	1.70	1.83	1.96	2.03	2.19	2.30	2.40	2.50	2.59	2.68	2.77	2.86	2.94	3.02	3.10	3.17	3.25	3.32	3.39	3.46

TVI 80° - HOLLOW CONE

	5 Bar	10 Bar	15 Bar
TVI-80005	XC	C	C
TVI-800075	XC	C	C
TVI-80015	XC	C	C
TVI-8002	XC	XC	VC
TVI-80025	XC	XC	VC

Features	
Common Use	Plant Health
Pattern	Hollow Cone
Technology	Air Induction
Material	Ceramic
Spray Angle	80°
Pressure Range	70-360 PSI (5-25 BAR)
Configuration	Nozzle
Part Numbers	
Nozzles 80°	Caps (25 Pack)
TVI-80005	CAP05-20
TVI-800075	CAP05-20
TVI-80015	CAP05-20
TVI-8002	CAP05-20
TVI-80025	CAP05-20
TVI-8003	CAP05-20

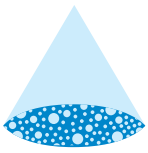

FLAT FANS - CERAMIC AVI 80°



The AVI 80° air-inducing fan pattern spray nozzle is ideal for use in directed spray applications and on air-blast sprayers. Research shows AVI spray nozzles can be used to deliver more spray on target with less loss to airborne drift and to the ground than conventional applications.

- ◆ Ceramic orifice for extra long life and accuracy
- ◆ Venturi design delivers more spray on-target
- ◆ Color coded for simple selection
- ◆ 110° fan model ideal for broadcast spraying (See page 158 for more info.)

US UNITS

Spray Nozzle	Flow Rate, GPM												
	Pressure (PSI)												
	40	50	60	70	80	90	100	120	150	200	250	300	350
01	0.100	0.112	0.122	0.132	0.141	0.150	0.158	0.173	0.194	0.224	0.250	0.274	0.296
015	0.150	0.168	0.184	0.198	0.212	0.225	0.237	0.260	0.290	0.335	0.375	0.411	0.444
02	0.200	0.224	0.245	0.265	0.283	0.300	0.316	0.346	0.387	0.447	0.500	0.548	0.592
025	0.250	0.280	0.306	0.331	0.354	0.375	0.395	0.433	0.484	0.559	0.625	0.685	0.740
03	0.300	0.335	0.367	0.397	0.424	0.450	0.474	0.520	0.581	0.671	0.750	0.822	0.887
04	0.400	0.447	0.490	0.529	0.566	0.600	0.632	0.693	0.775	0.894	1.000	1.095	1.183

METRIC UNITS

Spray Nozzle	Flow Rate, LPM												
	Pressure (BAR)												
	2.1	2.8	3.4	4.1	4.8	5.5	6.9	8.3	10.3	13.8	17.2	20.7	24.1
01	0.329	0.379	0.424	0.462	0.500	0.534	0.598	0.655	0.734	0.848	0.946	1.037	1.120
015	0.492	0.568	0.636	0.697	0.750	0.803	0.897	0.984	1.098	1.268	1.420	1.556	1.681
02	0.655	0.757	0.848	0.927	1.003	1.071	1.196	1.310	1.465	1.692	1.893	2.074	2.241
025	0.821	0.946	1.060	1.158	1.253	1.340	1.495	1.639	1.832	2.116	2.366	2.593	2.801
03	0.984	1.136	1.268	1.389	1.503	1.605	1.794	1.968	2.199	2.540	2.839	3.112	3.358
04	1.310	1.514	1.692	1.855	2.002	2.143	2.392	2.623	2.934	3.384	3.785	4.145	4.478

Features	
Common Use	Plant Health
Pattern	Tapered Flat Fan
Technology	Air Induction
Material	Ceramic
Spray Angle	80°
Pressure Range	40-350 PSI (3-24 BAR)
Configuration	Nozzle
Part Numbers	
Nozzles 80°	Caps (25 Pack)
AVI-8001	CAP01-01
AVI-80015	CAP01-015
AVI-8002	CAP01-02
AVI-80025	CAP01-025
AVI-8003	CAP01-03
AVI-8004	CAP01-04

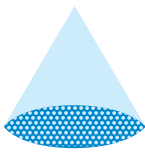

FLAT FAN - CERAMIC AXI 80°



The AXI 80° extended range fan pattern nozzle can be used for directed applications of a variety of chemistries and products. They are well suited to applications where smaller droplets are favored. They are equipped with a ceramic orifice to provide long-lasting performance.

- ◆ Ceramic orifice for extra long life
- ◆ Simple, reliable design
- ◆ Color coded for simple selection
- ◆ FastCap includes nozzle, cap and gasket
- ◆ 110° fan model ideal for broadcast spraying (See page 161 for more info.)

US UNITS

Spray Nozzle	Flow Rate (GPM)												
	Pressure (PSI)												
	40	50	60	70	80	90	100	120	150	200	250	300	350
015	0.150	0.168	0.184	0.198	0.212	0.225	0.237	0.260	0.290	0.335	0.375	0.411	0.444
02	0.200	0.224	0.245	0.265	0.283	0.300	0.316	0.346	0.387	0.447	0.500	0.548	0.592
025	0.250	0.280	0.306	0.331	0.354	0.375	0.395	0.433	0.484	0.559	0.625	0.685	0.740
03	0.300	0.335	0.367	0.397	0.424	0.450	0.474	0.520	0.581	0.671	0.750	0.822	0.887
04	0.400	0.447	0.490	0.529	0.566	0.600	0.632	0.693	0.775	0.894	1.000	1.095	1.183
05	0.500	0.559	0.612	0.661	0.707	0.750	0.791	0.866	0.968	1.118	1.250	1.369	1.479
06	0.600	0.671	0.735	0.794	0.849	0.900	0.949	1.039	1.162	1.342	1.500	1.643	1.775

METRIC UNITS

Spray Nozzle	Flow Rate (LPM)												
	Pressure (BAR)												
	1.4	2.8	3.4	4.1	4.8	5.5	6.9	8.3	10.3	13.8	17.2	20.7	24.1
015	0.401	0.568	0.636	0.697	0.750	0.803	0.897	0.984	1.098	1.268	1.420	1.556	1.681
02	0.534	0.757	0.848	0.927	1.003	1.071	1.196	1.310	1.465	1.692	1.893	2.074	2.241
025	0.670	0.946	1.060	1.158	1.253	1.340	1.495	1.639	1.832	2.116	2.366	2.593	2.801
03	0.803	1.136	1.268	1.389	1.503	1.605	1.794	1.968	2.199	2.540	2.839	3.112	3.358
04	1.071	1.514	1.692	1.855	2.002	2.143	2.392	2.623	2.934	3.384	3.785	4.145	4.478
05	1.340	1.893	2.116	2.317	2.502	2.676	2.994	3.278	3.664	4.232	4.732	5.182	5.599
06	1.605	2.271	2.540	2.782	3.006	3.214	3.592	3.933	4.399	5.080	5.678	6.219	6.719

Features	
Common Use	Plant Health
Pattern	Tapered Flat Fan
Technology	Elliptical Orifice
Material	Ceramic
Spray Angle	80°
Pressure Range	40-350 PSI(3-24 BAR)
Configuration	Nozzle, Fast Cap
Part Numbers	
Nozzles 80°	FastCaps 80°
AXI-80015	FC-AXI-80015
AXI-8002	FC-AXI-8002
AXI-8003	FC-AXI-8003
AXI-8004	FC-AXI-8004
AXI-8005	FC-AXI-8005
AXI-8006	FC-AXI-8006

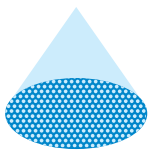

FULL CONE - CERAMIC DISCS & CORES 14°-71°



Albuz® Ceramic discs and cores are the longest lasting disc-core nozzles, making them ideal for abrasive agricultural and horticultural sprays. DCC/CRC nozzles will outlast stainless steel disc-core nozzles by up to 10 times and perform superbly at high pressures common on many air-blast and directed sprays.

US UNITS

DISC	Full Cone CORE	Flow Rate GPM										Spray Angle Degrees		
		Pressure (PSI)										Pressure (PSI)		
		10	20	30	40	60	80	100	150	200	300	20	40	80
DCC-01	CRC-31	0.08	0.11	0.13	0.15	0.18	0.20	0.23	0.27	0.31	0.37	49	47	43
DCC-02	CRC-31	0.12	0.16	0.19	0.22	0.26	0.30	0.33	0.40	0.45	0.55	62	63	61
DCC-03	CRC-31	0.13	0.18	0.21	0.24	0.29	0.33	0.37	0.44	0.50	0.6	63	65	63
DCC-01	CRC-35	0.08	0.11	0.13	0.14	0.17	0.2	0.22	0.26	0.29	0.35	19	23	26
DCC-02	CRC-35	0.14	0.18	0.24	0.25	0.3	0.34	0.37	0.45	0.51	0.60	40	44	47
DCC-03	CRC-35	0.16	0.22	0.26	0.30	0.36	0.41	0.45	0.55	0.62	0.74	45	50	52
DCC-04	CRC-35	0.27	0.37	0.44	0.50	0.60	0.70	0.79	0.93	1.10	1.30	68	70	71
DCC-05	CRC-35	0.34	0.48	0.58	0.66	0.8	0.92	1.00	1.20	1.40	1.70	67	69	71
DCC-02	CRC-56	-	-	0.21	0.25	0.3	0.35	0.39	0.47	5.50	0.67	-	14	17
DCC-03	CRC-56	-	-	0.29	0.34	0.41	0.48	0.53	0.65	7.50	0.92	-	20	23
DCC-04	CRC-56	-	0.39	0.48	0.55	0.67	0.78	0.87	1.10	1.20	1.50	20	26	29
DCC-05	CRC-56	0.38	0.54	0.66	0.76	0.93	1.10	1.20	1.50	1.70	2.10	26	32	34
DCC-06	CRC-56	0.55	0.78	0.95	1.10	1.40	1.60	1.70	2.10	2.50	3.00	34	39	41
DCC-07	CRC-56	0.76	1.10	1.30	1.50	1.90	2.20	2.40	2.90	3.40	4.20	45	52	54

Features		
Common Use	Plant Health	
Pattern	Full Cone	
Technology	Swirl	
Material	Ceramic	
Spray Angle	14°-71°	
Pressure Range	10-300 PSI (1-20 BAR)	
Configuration	Nozzle	
Part Numbers		
Discs	Cores	Caps (25 Pack)
DCC-01	CRC-31	CAP05-20
DCC-02	CRC-35	CAP05-20
DCC-03	CRC-56	CAP05-20
DCC-04	-	CAP05-20
DCC-05	-	CAP05-20
DCC-06	-	CAP05-20
DCC-07	-	CAP05-20

METRIC UNITS

DISC	Full Cone CORE	Flow Rate GPM								Spray Angle Degrees	
		Pressure (BAR)								Pressure (BAR)	
		3	4	5	6	10	15	20	10	20	
DCC-01	CRC-31	-	-	-	-	1.0	1.2	1.4	38	40	
DCC-02	CRC-31	-	-	-	-	1.5	1.8	2.0	49	54	
DCC-03	CRC-31	-	-	-	-	1.6	1.9	2.2	58	67	
DCC-01	CRC-35	-	-	-	-	1.0	1.2	1.3	27	27	
DCC-02	CRC-35	-	-	-	-	1.7	2.0	2.2	40	45	
DCC-03	CRC-35	-	-	-	-	2.0	2.4	2.8	42	48	
DCC-04	CRC-35	-	-	-	-	3.5	4.2	4.8	60	68	
DCC-05	CRC-35	2.6	3.0	3.3	3.6	4.5	5.5	6.3	62	69	
DCC-02	CRC-56	1.0	1.1	1.2	1.4	1.8	2.2	2.5	16	18	
DCC-03	CRC-56	1.3	1.6	1.7	1.9	2.4	3.0	3.4	22	24	
DCC-04	CRC-56	2.2	2.5	2.8	3.1	4.0	4.8	5.6	28	30	
DCC-05	CRC-56	3.0	3.5	3.9	4.3	5.5	6.7	7.8	33	35	
DCC-06	CRC-56	4.5	5.3	5.9	6.5	8.5	10.2	11.9	38	40	
DCC-07	CRC-56	6.0	6.9	7.7	8.5	11.0	13.5	15.6	51	53	

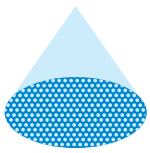

FULL CONE DIRECTED - FCX 80°



The FCX full-cone spray nozzle is especially suited for coverage sensitive applications of insecticide/fungicides.

- ◆ Full cone pattern to give superior coverage with non-air inducted droplets
- ◆ 80° spray angle makes the product easy to direct for spot applications
- ◆ Broad operating range for application flexibility

US UNITS

Nozzle Size	Pressure (PSI)	Flow Rate (GPM)	Gallons per Acre 20 inch nozzle spacing								GAL/1000ft ²			
			MPH								20 inch nozzle spacing			
			4	5	6	8	10	12	15	20	2	3	4	5
02	15	0.20	14.9	11.9	9.9	7.4	5.9	5.0	4.0	3.0	0.68	0.45	0.34	0.27
	20	0.23	17.1	13.7	11.4	8.5	6.8	5.7	4.6	3.4	0.78	0.52	0.39	0.31
	30	0.28	20.8	16.6	13.9	10.4	8.3	6.9	5.5	4.2	0.95	0.64	0.48	0.38
	40	0.33	24.5	19.6	16.3	12.3	9.8	8.2	6.5	4.9	1.13	0.75	0.56	0.45
	50	0.37	27.5	22.0	18.3	13.7	11.0	9.2	7.3	5.5	1.26	0.84	0.63	0.50
	60	0.40	29.7	23.8	19.8	14.9	11.9	9.9	7.9	5.9	1.36	0.91	0.68	0.55
	70	0.43	31.9	25.5	21.3	16.0	12.8	10.6	8.5	6.4	1.47	0.98	0.73	0.59
	80	0.46	34.2	27.3	22.8	17.1	13.7	11.4	9.1	6.8	1.57	1.05	0.78	0.63
	100	0.52	38.6	30.9	25.7	19.3	15.4	12.9	10.3	7.7	1.77	1.18	0.89	0.71
	125	0.58	43.1	34.5	28.7	21.5	17.2	14.4	11.5	8.6	1.98	1.32	0.99	0.79
150	0.63	46.8	37.4	31.2	23.4	18.7	15.6	12.5	9.4	2.15	1.43	1.07	0.86	
03	15	0.30	22.3	17.8	14.9	11.1	8.9	7.4	5.9	4.5	1.02	0.68	0.51	0.41
	20	0.35	26.0	20.8	17.3	13.0	10.4	8.7	6.9	5.2	1.19	0.80	0.60	0.48
	30	0.42	31.2	24.9	20.8	15.6	12.5	10.4	8.3	6.2	1.43	0.95	0.72	0.57
	40	0.49	36.4	29.1	24.3	18.2	14.6	12.1	9.7	7.3	1.67	1.11	0.84	0.67
	50	0.55	40.8	32.7	27.2	20.4	16.3	13.6	10.9	8.2	1.88	1.25	0.94	0.75
	60	0.60	44.6	35.6	29.7	22.3	17.8	14.9	11.9	8.9	2.05	1.36	1.02	0.82
	70	0.65	48.3	38.6	32.2	24.1	19.3	16.1	12.9	9.7	2.22	1.48	1.11	0.89
	80	0.69	51.2	41.0	34.2	25.6	20.5	17.1	13.7	10.2	2.35	1.57	1.18	0.94
	100	0.77	57.2	45.7	38.1	28.6	22.9	19.1	15.2	11.4	2.63	1.75	1.31	1.05
	125	0.87	64.6	51.7	43.1	32.3	25.8	21.5	17.2	12.9	2.97	1.98	1.48	1.19
150	0.95	70.5	56.4	47.0	35.3	28.2	23.5	18.8	14.1	3.24	2.16	1.62	1.30	
04	15	0.40	29.7	23.8	19.8	14.9	11.9	9.9	7.9	5.9	1.36	0.91	0.68	0.55
	20	0.46	34.2	27.3	22.8	17.1	13.7	11.4	9.1	6.8	1.57	1.05	0.78	0.63
	30	0.57	42.3	33.9	28.2	21.2	16.9	14.1	11.3	8.5	1.94	1.30	0.97	0.78
	40	0.65	48.3	38.6	32.2	24.1	19.3	16.1	12.9	9.7	2.22	1.48	1.11	0.89
	50	0.73	54.2	43.4	36.1	27.1	21.7	18.1	14.5	10.8	2.49	1.66	1.24	1.00
	60	0.80	59.4	47.5	39.6	29.7	23.8	19.8	15.8	11.9	2.73	1.82	1.36	1.09
	70	0.86	63.9	51.1	42.6	31.9	25.5	21.3	17.0	12.8	2.93	1.96	1.47	1.17
	80	0.92	68.3	54.6	45.5	34.2	27.3	22.8	18.2	13.7	3.14	2.09	1.57	1.25
	100	1.03	76.5	61.2	51.0	38.2	30.6	25.5	20.4	15.3	3.51	2.34	1.76	1.40
	125	1.15	85.4	68.3	56.9	42.7	34.2	28.5	22.8	17.1	3.92	2.61	1.96	1.57
150	1.26	93.6	74.8	62.4	46.8	37.4	31.2	24.9	18.7	4.30	2.86	2.15	1.72	
05	15	0.50	37.1	29.7	24.8	18.6	14.9	12.4	9.9	7.4	1.71	1.14	0.85	0.68
	20	0.58	43.1	34.5	28.7	21.5	17.2	14.4	11.5	8.6	1.98	1.32	0.99	0.79
	30	0.71	52.7	42.2	35.1	26.4	21.1	17.6	14.1	10.5	2.42	1.61	1.21	0.97
	40	0.82	60.9	48.7	40.6	30.4	24.4	20.3	16.2	12.2	2.80	1.86	1.40	1.12
	50	0.91	67.6	54.1	45.0	33.8	27.0	22.5	18.0	13.5	3.10	2.07	1.55	1.24
	60	1.00	74.3	59.4	49.5	37.1	29.7	24.8	19.8	14.9	3.41	2.27	1.71	1.36
	70	1.08	80.2	64.2	53.5	40.1	32.1	26.7	21.4	16.0	3.68	2.46	1.84	1.47
	80	1.15	85.4	68.3	56.9	42.7	34.2	28.5	22.8	17.1	3.92	2.61	1.96	1.57
	100	1.29	95.8	76.6	63.9	47.9	38.3	31.9	25.5	19.2	4.40	2.93	2.20	1.76
	125	1.44	107	85.5	71.3	53.5	42.8	35.6	28.5	21.4	4.91	3.27	2.46	1.96
150	1.58	117	93.9	78.2	58.7	46.9	39.1	31.3	23.5	5.39	3.59	2.69	2.16	
06	15	0.60	44.6	35.6	29.7	22.3	17.8	14.9	11.9	8.9	2.05	1.36	1.02	0.82
	20	0.69	51.2	41.0	34.2	25.6	20.5	17.1	13.7	10.2	2.35	1.57	1.18	0.94
	30	0.85	63.1	50.5	42.1	31.6	25.2	21.0	16.8	12.6	2.90	1.93	1.45	1.16
	40	0.98	72.8	58.2	48.5	36.4	29.1	24.3	19.4	14.6	3.34	2.23	1.67	1.34
	50	1.10	81.7	65.3	54.5	40.8	32.7	27.2	21.8	16.3	3.75	2.50	1.88	1.50
	60	1.20	89.1	71.3	59.4	44.6	35.6	29.7	23.8	17.8	4.09	2.73	2.05	1.64
	70	1.30	96.5	77.2	64.4	48.3	38.6	32.2	25.7	19.3	4.43	2.96	2.22	1.77
	80	1.39	103	82.6	68.8	51.6	41.3	34.4	27.5	20.6	4.74	3.16	2.37	1.90
	100	1.55	115	92.1	76.7	57.5	46.0	38.4	30.7	23.0	5.29	3.52	2.64	2.11
	125	1.73	128	103	85.6	64.2	51.4	42.8	34.3	25.7	5.90	3.93	2.95	2.36
150	1.90	141	113	94.1	70.5	56.4	47.0	37.6	28.2	6.48	4.32	3.24	2.59	



METRIC UNITS

Nozzle Size	Pressure (BAR)	Flow Rate (LPM)	Flow L/min- 50 cm Spacing							
			KMH							
			7	8	10	12	15	20	25	30
02	1	0,74	127	111	89	74	59	44	36	30
	2	1,05	180	158	126	105	84	63	50	42
	3	1,28	219	192	154	128	102	77	61	51
	4	1,48	254	222	178	148	118	89	71	59
	5	1,65	283	248	198	165	132	99	79	66
	6	1,81	310	272	217	181	145	109	87	72
	7	1,96	336	294	235	196	157	118	94	78
	8	2,09	358	314	251	209	167	125	100	84
	9	2,22	381	333	266	222	178	133	107	89
	10	2,34	401	351	281	234	187	140	112	94
03	1	1,12	192	168	134	112	90	67	54	45
	2	1,58	271	237	190	158	126	95	76	63
	3	1,94	333	291	233	194	155	116	93	78
	4	2,23	382	335	268	223	178	134	107	89
	5	2,50	429	375	300	250	200	150	120	100
	6	2,73	468	410	328	273	218	164	131	109
	7	2,96	507	444	355	296	237	178	142	118
	8	3,17	543	476	380	317	254	190	152	127
	9	3,36	576	504	403	336	269	202	161	134
	10	3,54	607	531	425	354	283	212	170	142
04	1	1,49	255	224	179	149	119	89	72	60
	2	2,11	362	317	253	211	169	127	101	84
	3	2,58	442	387	310	258	206	155	124	103
	4	2,98	511	447	358	298	238	179	143	119
	5	3,33	571	500	400	333	266	200	160	133
	6	3,65	626	548	438	365	292	219	175	146
	7	3,94	675	591	473	394	315	236	189	158
	8	4,21	722	632	505	421	337	253	202	168
	9	4,47	766	671	536	447	358	268	215	179
	10	4,71	807	707	565	471	377	283	226	188
05	1	1,86	319	279	223	186	149	112	89	74
	2	2,63	451	395	316	263	210	158	126	105
	3	3,22	552	483	386	322	258	193	155	129
	4	3,72	638	558	446	372	298	223	179	149
	5	4,16	713	624	499	416	333	250	200	166
	6	4,56	782	684	547	456	365	274	219	182
	7	4,92	843	738	590	492	394	295	236	197
	8	5,26	902	789	631	526	421	316	252	210
	9	5,58	957	837	670	558	446	335	268	223
	10	5,88	1008	882	706	588	470	353	282	235
06	1	2,23	382	335	268	223	178	134	107	89
	2	3,15	540	473	378	315	252	189	151	126
	3	3,86	662	579	463	386	309	232	185	154
	4	4,45	763	668	534	445	356	267	214	178
	5	4,98	854	747	598	498	398	299	239	199
	6	5,45	934	818	654	545	436	327	262	218
	7	5,89	1010	884	707	589	471	353	283	236
	8	6,29	1078	944	755	629	503	377	302	252
	9	6,69	1147	1004	803	669	535	401	321	268
	10	7,05	1209	1058	846	705	564	423	338	282

Features	
Common Use	Plant Health
Pattern	Full Cone
Technology	Swirl
Material	Polyacetal
Spray Angle	80°
Pressure Range	15-150 PSI (1-10 BAR)
Configuration	Nozzle
Part Numbers (Bags of 10)	
Nozzles 80°	Caps (25 Pack)
30FCX02	CAP04-02
30FCX03	CAP04-03
30FCX04	CAP04-04
30FCX05	CAP04-05
30FCX06	CAP04-06

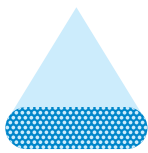

EVEN 80°



The Hypro® Even Flat Fan spray nozzle is an excellent choice for banding and directed post application. An even spray pattern should be used when banding chemicals.

- ◆ Commonly used in hand-held applications
- ◆ Even spray pattern provides a precise application rate where no spray overlap is desired
- ◆ Large range of flow rates available to meet your application requirements

US UNITS

Nozzle Size	Droplet Size	Pressure (PSI)	Flow Rate (GPM)	Gallons per Acre 10 inch band				Gallons per Acre 12 inch band				Gallons per Acre 15 inch band			
				MPH				MPH				MPH			
				4	5	6	7	4	5	6	7	4	5	6	7
01	F	30	0.09	13.4	10.7	8.9	7.6	11.1	8.9	7.4	6.4	8.9	7.1	5.9	5.1
	F	40	0.10	14.9	11.9	9.9	8.5	12.4	9.9	8.3	7.1	9.9	7.9	6.6	5.7
	VF	50	0.11	16.3	13.1	10.9	9.3	13.6	10.9	9.1	7.8	10.9	8.7	7.3	6.2
	VF	60	0.12	17.8	14.3	11.9	10.2	14.9	11.9	9.9	8.5	11.9	9.5	7.9	6.8
015	F	30	0.13	19.3	15.4	12.9	11.0	16.1	12.9	10.7	9.2	12.9	10.3	8.6	7.4
	F	40	0.15	22.3	17.8	14.9	12.7	18.6	14.9	12.4	10.6	14.9	11.9	9.9	8.5
	F	50	0.17	25.2	20.2	16.8	14.4	21.0	16.8	14.0	12.0	16.8	13.5	11.2	9.6
	VF	60	0.18	26.7	21.4	17.8	15.3	22.3	17.8	14.9	12.7	17.8	14.3	11.9	10.2
02	M	30	0.17	25.2	20.2	16.8	14.4	21.0	16.8	14.0	12.0	16.8	13.5	11.2	9.6
	F	40	0.20	29.7	23.8	19.8	17.0	24.8	19.8	16.5	14.1	19.8	15.8	13.2	11.3
	F	50	0.22	32.7	26.1	21.8	18.7	27.2	21.8	18.2	15.6	21.8	17.4	14.5	12.4
	F	60	0.24	35.6	28.5	23.8	20.4	29.7	23.8	19.8	17.0	23.8	19.0	15.8	13.6
03	M	30	0.26	38.6	30.9	25.7	22.1	32.2	25.7	21.5	18.4	25.7	20.6	17.2	14.7
	F	40	0.30	44.6	35.6	29.7	25.5	37.1	29.7	24.8	21.2	29.7	23.8	19.8	17.0
	F	50	0.34	50.5	40.4	33.7	28.9	42.1	33.7	28.1	24.0	33.7	26.9	22.4	19.2
	F	60	0.37	54.9	44.0	36.6	31.4	45.8	36.6	30.5	26.2	36.6	29.3	24.4	20.9
04	M	30	0.35	52.0	41.6	34.7	29.7	43.3	34.7	28.9	24.8	34.7	27.7	23.1	19.8
	M	40	0.40	59.4	47.5	39.6	33.9	49.5	39.6	33.0	28.3	39.6	31.7	26.4	22.6
	F	50	0.45	66.8	53.5	44.6	38.2	55.7	44.6	37.1	31.8	44.6	35.6	29.7	25.5
	F	60	0.49	72.8	58.2	48.5	41.6	60.6	48.5	40.4	34.7	48.5	38.8	32.3	27.7
05	M	30	0.43	63.9	51.1	42.6	36.5	53.2	42.6	35.5	30.4	42.6	34.1	28.4	24.3
	M	40	0.50	74.3	59.4	49.5	42.4	61.9	49.5	41.3	35.4	49.5	39.6	33.0	28.3
	M	50	0.56	83.2	66.5	55.4	47.5	69.3	55.4	46.2	39.6	55.4	44.4	37.0	31.7
	F	60	0.61	90.6	72.5	60.4	51.8	75.5	60.4	50.3	43.1	60.4	48.3	40.3	34.5
06	C	30	0.52	77.2	61.8	51.5	44.1	64.4	51.5	42.9	36.8	51.5	41.2	34.3	29.4
	C	40	0.60	89.1	71.3	59.4	50.9	74.3	59.4	49.5	42.4	59.4	47.5	39.6	33.9
	C	50	0.67	99.5	79.6	66.3	56.9	82.9	66.3	55.3	47.4	66.3	53.1	44.2	37.9
	C	60	0.73	108	86.7	72.3	61.9	90.3	72.3	60.2	51.6	72.3	57.8	48.2	41.3
08	VC	30	0.69	102	82.0	68.3	58.6	85.4	68.3	56.9	48.8	68.3	54.6	45.5	39.0
	C	40	0.80	119	95.0	79.2	67.9	99.0	79.2	66.0	56.6	79.2	63.4	52.8	45.3
	C	50	0.89	132	106	88.1	75.5	110	88.1	73.4	62.9	88.1	70.5	58.7	50.3
	C	60	0.98	146	116	97.0	83.2	121	97.0	80.9	69.3	97.0	77.6	64.7	55.4

Droplet size based on ASABE S572.1 standard.

METRIC UNITS

Nozzle Size	Droplet Size	Pressure (BAR)	Flow Rate (LPM)	In-Band Application Rate (L/Ha) 25 cm (km/h)				In-Band Application Rate (L/Ha) 30 cm (km/h)				In-Band Application Rate (L/Ha) 40 cm (km/h)			
				6	8	10	12	6	8	10	12	6	8	10	12
01	F	2	0.33	132	99	79	66	110	83	66	55	83	62	50	41
	F	2.5	0.37	148	111	89	74	123	93	74	62	93	69	56	46
	F	3	0.40	160	120	96	80	133	100	80	67	100	75	60	50
	VF	4	0.46	184	138	110	92	153	115	92	77	115	86	69	58
015	F	2	0.49	196	147	118	98	163	123	98	82	123	92	74	61
	F	2.5	0.55	220	165	132	110	183	138	110	92	138	103	83	69
	F	3	0.60	240	180	144	120	200	150	120	100	150	113	90	75
	VF	4	0.69	276	207	166	138	230	173	138	115	173	129	104	86
02	M	2	0.65	260	195	156	130	217	163	130	108	163	122	98	81
	F	2.5	0.73	292	219	175	146	243	183	146	122	183	137	110	91
	F	3	0.80	320	240	192	160	267	200	160	133	200	150	120	100
	F	4	0.92	368	276	221	184	307	230	184	153	230	173	138	115
03	M	2	0.98	392	294	235	196	327	245	196	163	245	184	147	123
	M	2.5	1.10	440	330	264	220	367	275	220	183	275	206	165	138
	F	3	1.20	480	360	288	240	400	300	240	200	300	225	180	150
	F	4	1.39	556	417	334	278	463	348	278	232	348	261	209	174
04	M	2	1.31	524	393	314	262	437	328	262	218	328	246	197	164
	M	2.5	1.46	584	438	350	292	487	365	292	243	365	274	219	183
	M	3	1.60	640	480	384	320	533	400	320	267	400	300	240	200
	F	4	1.85	740	555	444	370	617	463	370	308	463	347	278	231
05	M	2	1.63	652	489	391	326	543	408	326	272	408	306	245	204
	M	2.5	1.83	732	549	439	366	610	458	366	305	458	343	275	229
	M	3	2.00	800	600	480	400	667	500	400	333	500	375	300	250
	F	4	2.31	924	693	554	462	770	578	462	385	578	433	347	289
06	C	2	1.96	784	588	470	392	653	490	392	327	490	368	294	245
	C	2.5	2.19	876	657	526	438	730	548	438	365	548	411	329	274
	C	3	2.40	960	720	576	480	800	600	480	400	600	450	360	300
	C	4	2.77	1108	831	665	554	923	693	554	462	693	519	416	346
08	VC	2	2.61	1044	783	626	522	870	653	522	435	653	489	392	326
	C	2.5	2.92	1168	876	701	584	973	730	584	487	730	548	438	365
	C	3	3.20	1280	960	768	640	1067	800	640	533	800	600	480	400
	C	4	3.70	1480	1110	888	740	1233	925	740	617	925	694	555	463

Droplet size based on ASABE S572.1 standard.

Features	
Common Use	Weeds
Pattern	Even Flat Fan
Technology	Elliptical Orifice
Material	Polyacetal
Spray Angle	80°
Pressure Range	30-60 PSI (2-4 BAR)
Configuration	Nozzle
Part Numbers (Bags of 10)	
Nozzles 80°	Caps (25 Pack)
E80-01	CAP00-01
E80-015	CAP00-015
E80-02	CAP00-02
E80-03	CAP00-03
E80-04	CAP00-04
E80-05	CAP00-05
E80-06	CAP00-06
E80-08	CAP00-08



BRASS OFF-CENTER OC 80°



The Hypro® OC flat fan off-center brass spray nozzle is an economical nozzle for spraying around obstacles or defining the edge of a spray swath.

- ◆ Creates half of a broadcast pattern
- ◆ Generally positioned at the end of a boom
- ◆ Designed for use with overlapping broadcast patterns to provide precise width control

US UNITS

Nozzle Size	Droplet Size 80°	Pressure (PSI)	Flow Rate (GPM)	Gallons per Acre 20 inch nozzle spacing								GAL/1000 ^{F12}			
				MPH								20 inch nozzle spacing			
				4	5	6	8	10	12	15	20	2	3	4	5
02	M	30	0.17	12.6	10.1	8.4	6.3	5.0	4.2	3.4	2.5	0.58	0.39	0.29	0.23
	F	40	0.20	14.9	11.9	9.9	7.4	5.9	5.0	4.0	3.0	0.68	0.45	0.34	0.27
	F	50	0.22	16.3	13.1	10.9	8.2	6.5	5.4	4.4	3.3	0.75	0.50	0.38	0.30
03	M	30	0.26	19.3	15.4	12.9	9.7	7.7	6.4	5.1	3.9	0.89	0.59	0.44	0.35
	F	40	0.30	22.3	17.8	14.9	11.1	8.9	7.4	5.9	4.5	1.02	0.68	0.51	0.41
	F	50	0.34	25.2	20.2	16.8	12.6	10.1	8.4	6.7	5.0	1.16	0.77	0.58	0.46
04	M	30	0.35	26.0	20.8	17.3	13.0	10.4	8.7	6.9	5.2	1.19	0.80	0.60	0.48
	M	40	0.40	29.7	23.8	19.8	14.9	11.9	9.9	7.9	5.9	1.36	0.91	0.68	0.55
	F	50	0.45	33.4	26.7	22.3	16.7	13.4	11.1	8.9	6.7	1.53	1.02	0.77	0.61
06	C	30	0.52	38.6	30.9	25.7	19.3	15.4	12.9	10.3	7.7	1.77	1.18	0.89	0.71
	M	40	0.60	44.6	35.6	29.7	22.3	17.8	14.9	11.9	8.9	2.05	1.36	1.02	0.82
	M	50	0.67	49.7	39.8	33.2	24.9	19.9	16.6	13.3	9.9	2.28	1.52	1.14	0.91
08	C	30	0.69	51.2	41.0	34.2	25.6	20.5	17.1	13.7	10.2	2.35	1.57	1.18	0.94
	M	40	0.80	59.4	47.5	39.6	29.7	23.8	19.8	15.8	11.9	2.73	1.82	1.36	1.09
	M	50	0.89	66.1	52.9	44.1	33.0	26.4	22.0	17.6	13.2	3.03	2.02	1.52	1.21
12	C	30	1.04	77.2	61.8	51.5	38.6	30.9	25.7	20.6	15.4	3.55	2.36	1.77	1.42
	C	40	1.20	89.1	71.3	59.4	44.6	35.6	29.7	23.8	17.8	4.09	2.73	2.05	1.64
	M	50	1.34	99.5	79.6	66.3	49.7	39.8	33.2	26.5	19.9	4.57	3.05	2.28	1.83
16	C	30	1.47	109	87.3	72.8	54.6	43.7	36.4	29.1	21.8	5.01	3.34	2.51	2.01
	C	40	1.60	120	95.0	79.2	59.4	47.5	39.6	31.7	23.8	5.46	3.64	2.73	2.18
	C	50	1.79	133	106	88.6	66.5	53.2	44.3	35.4	26.6	6.10	4.07	3.05	2.44
16	C	60	1.96	146	116	97.0	72.8	58.2	48.5	38.8	29.1	6.68	4.46	3.34	2.67

Droplet size based on ASABE S572.1 standard.

Features	
Common Use	Unspecialized
Pattern	Off-Center Fan
Technology	Elliptical Orifice
Material	Brass
Spray Angle	80°
Pressure Range	30-60 PSI (2-4 BAR)
Configuration	Nozzle
Part Numbers	
Nozzles 80°	Caps (25 Pack)
280C02	CAP00-20
280C03	CAP00-20
280C04	CAP00-20
280C06	CAP00-20
280C08	CAP00-20
280C12	CAP00-20
280C16	CAP00-20

METRIC UNITS

Nozzle Size	Droplet Size 80°	Pressure (BAR)	Flow Rate (LPM)	Application Rate L/Ha - 50 cm Spacing							
				KM/H							
				7	8	10	12	15	20	25	30
02	M	2	0.65	130	98	78	65	52	39	31	26
	F	2.5	0.73	146	110	88	73	58	44	35	29
	F	3	0.80	160	120	96	80	64	48	38	32
03	M	2	0.98	184	138	110	92	74	55	44	37
	F	2.5	1.10	220	165	132	110	88	66	53	44
	F	3	1.20	240	180	144	120	96	72	58	48
04	M	2	1.31	278	209	167	139	111	83	67	56
	M	2.5	1.46	320	240	192	160	128	96	77	64
	F	3	1.60	370	278	222	185	148	111	89	74
06	C	2	1.96	480	360	288	240	192	144	115	96
	M	2.5	2.19	554	416	332	277	222	166	133	111
	M	3	2.40	640	480	384	320	256	192	154	128
08	C	2	2.61	740	555	444	370	296	222	178	148
	C	2.5	2.92	840	630	504	420	336	252	200	166
	M	3	3.20	960	720	576	480	384	288	230	192
12	C	2	3.92	1108	831	665	554	443	332	266	222
	C	2.5	4.38	1260	945	756	630	504	396	310	256
	M	3	4.80	1440	1080	864	720	576	450	360	296
16	C	2	5.23	1646	1235	988	818	655	514	404	334
	C	2.5	5.84	1880	1410	1128	936	750	590	460	384
	C	3	6.40	2160	1620	1296	1080	864	672	520	424
16	C	4	7.39	2478	1859	1487	1239	991	773	604	500

Droplet size based on ASABE S572.1 standard.

CERAMIC OFF-CENTER OCI 80°

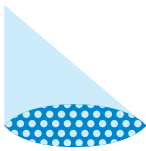

The Albu^z® OCI off-center flat fan ceramic spray nozzle provides excellent wear life for spraying around obstacles or defining the edge of a spraying swath.

US UNITS

Nozzle Size	Droplet Size 80°	Pressure (PSI)	Flow Rate (GPM)	Gallons per Acre 20 inch nozzle spacing								GAL/1000 ^{ft} ² 20 inch nozzle spacing			
				MPH											
				4	5	6	8	10	12	15	20	2	3	4	5
02	M	30	0.17	12.6	10.1	8.4	6.3	5.0	4.2	3.4	2.5	0.58	0.39	0.29	0.23
	M	40	0.20	14.9	11.9	9.9	7.4	5.9	5.0	4.0	3.0	0.68	0.45	0.34	0.27
	M	50	0.22	16.3	13.1	10.9	8.2	6.5	5.4	4.4	3.3	0.75	0.50	0.38	0.30
	F	60	0.24	17.8	14.3	11.9	8.9	7.1	5.9	4.8	3.6	0.82	0.55	0.41	0.33
03	M	30	0.26	19.3	15.4	12.9	9.7	7.7	6.4	5.1	3.9	0.89	0.59	0.44	0.35
	M	40	0.30	22.3	17.8	14.9	11.1	8.9	7.4	5.9	4.5	1.02	0.68	0.51	0.41
	M	50	0.34	25.2	20.2	16.8	12.6	10.1	8.4	6.7	5.0	1.16	0.77	0.58	0.46
	M	60	0.37	27.5	22.0	18.3	13.7	11.0	9.2	7.3	5.5	1.26	0.84	0.63	0.50
04	M	30	0.35	26.0	20.8	17.3	13.0	10.4	8.7	6.9	5.2	1.19	0.80	0.60	0.48
	M	40	0.40	29.7	23.8	19.8	14.9	11.9	9.9	7.9	5.9	1.36	0.91	0.68	0.55
	M	50	0.45	33.4	26.7	22.3	16.7	13.4	11.1	8.9	6.7	1.53	1.02	0.77	0.61
	M	60	0.49	36.4	29.1	24.3	18.2	14.6	12.1	9.7	7.3	1.67	1.11	0.84	0.67

Features	
Common Use	Unspecialized
Pattern	Off-Centered Fan
Technology	Elliptical Orifice
Material	Ceramic
Spray Angle	80°
Pressure Range	30-60 PSI (2-4 BAR)
Configuration	Nozzle
Part Numbers	
Nozzles 80°	Caps (25 Pack)
OCI-8002	CAP00-02
OCI-8003	CAP00-03
OCI-8004	CAP00-04

METRIC UNITS

Nozzle Size	Droplet Size 80°	Pressure (Bar)	Flow Rate (LPM)	Liters/Hectare											
				KM/H											
				4	5	6	7	8	9	10	12	14	16	18	20
02	M	2	0.65	195	156	130	111	98	87	78	65	56	49	43	39
	M	3	0.80	240	192	160	137	120	107	96	80	69	60	53	48
	F	4	0.91	273	218	182	156	137	121	109	91	78	68	61	55
03	M	2	0.98	294	235	196	168	147	131	118	98	84	74	65	59
	M	3	1.20	360	288	240	206	180	160	144	120	103	90	80	72
	M	4	1.39	417	334	278	238	209	185	167	139	119	104	93	83
04	M	2	1.31	393	314	262	225	197	175	157	131	112	98	87	79
	M	3	1.60	480	384	320	274	240	213	192	160	137	120	107	96
	M	4	1.85	555	444	370	317	278	247	222	185	159	139	123	111

FLAT FAN - CERAMIC AVI-OC 80°



The Albus® AVI-OC air-inducing Venturi off-center ceramic spray nozzle with air suction provides large, air-filled droplets that burst on impact with target.

US UNITS

Nozzle Size	Droplet Size 80°	Pressure (PSI)	Flow Rate (GPM)	Gallons per Acre 20 inch nozzle spacing										GAL/1000ft ² 20 inch nozzle spacing			
				MPH													
				4	5	6	8	10	12	15	20	2	3	4	5		
015	VC	40	0.15	11.1	8.9	7.4	5.6	4.5	3.7	3.0	2.2	0.51	0.34	0.26	0.20		
	VC	50	0.17	12.6	10.1	8.4	6.3	5.0	4.2	3.4	2.5	0.58	0.39	0.29	0.23		
	VC	60	0.18	13.4	10.7	8.9	6.7	5.3	4.5	3.6	2.7	0.61	0.41	0.31	0.25		
	VC	70	0.20	14.9	11.9	9.9	7.4	5.9	5.0	4.0	3.0	0.68	0.45	0.34	0.27		
	VC	80	0.21	15.6	12.5	10.4	7.8	6.2	5.2	4.2	3.1	0.72	0.48	0.36	0.29		
	C	90	0.23	17.1	13.7	11.4	8.5	6.8	5.7	4.6	3.4	0.78	0.52	0.39	0.31		
02	C	100	0.24	17.8	14.3	11.9	8.9	7.1	5.9	4.8	3.6	0.82	0.55	0.41	0.33		
	XC	40	0.20	14.9	11.9	9.9	7.4	5.9	5.0	4.0	3.0	0.68	0.45	0.34	0.27		
	VC	50	0.22	16.3	13.1	10.9	8.2	6.5	5.4	4.4	3.3	0.75	0.50	0.38	0.30		
	VC	60	0.24	17.8	14.3	11.9	8.9	7.1	5.9	4.8	3.6	0.82	0.55	0.41	0.33		
	VC	70	0.26	19.3	15.4	12.9	9.7	7.7	6.4	5.1	3.9	0.89	0.59	0.44	0.35		
	VC	80	0.28	20.8	16.6	13.9	10.4	8.3	6.9	5.5	4.2	0.95	0.64	0.48	0.38		
025	VC	90	0.30	22.3	17.8	14.9	11.1	8.9	7.4	5.9	4.5	1.02	0.68	0.51	0.41		
	VC	100	0.32	23.8	19.0	15.8	11.9	9.5	7.9	6.3	4.8	1.09	0.73	0.55	0.44		
	XC	40	0.25	18.6	14.9	12.4	9.3	7.4	6.2	5.0	3.7	0.85	0.57	0.43	0.34		
	XC	50	0.28	20.8	16.6	13.9	10.4	8.3	6.9	5.5	4.2	0.95	0.64	0.48	0.38		
	VC	60	0.31	23.0	18.4	15.3	11.5	9.2	7.7	6.1	4.6	1.06	0.70	0.53	0.42		
	VC	70	0.33	24.5	19.6	16.3	12.3	9.8	8.2	6.5	4.9	1.13	0.75	0.56	0.45		
03	VC	80	0.35	26.0	20.8	17.3	13.0	10.4	8.7	6.9	5.2	1.19	0.80	0.60	0.48		
	VC	90	0.38	28.2	22.6	18.8	14.1	11.3	9.4	7.5	5.6	1.30	0.86	0.65	0.52		
	VC	100	0.40	29.7	23.8	19.8	14.9	11.9	9.9	7.9	5.9	1.36	0.91	0.68	0.55		
	XC	40	0.30	22.3	17.8	14.9	11.1	8.9	7.4	5.9	4.5	1.02	0.68	0.51	0.41		
	XC	50	0.34	25.2	20.2	16.8	12.6	10.1	8.4	6.7	5.0	1.16	0.77	0.58	0.46		
	XC	60	0.37	27.5	22.0	18.3	13.7	11.0	9.2	7.3	5.5	1.26	0.84	0.63	0.50		
04	VC	70	0.40	29.7	23.8	19.8	14.9	11.9	9.9	7.9	5.9	1.36	0.91	0.68	0.55		
	VC	80	0.42	31.2	24.9	20.8	15.6	12.5	10.4	8.3	6.2	1.43	0.95	0.72	0.57		
	VC	90	0.45	33.4	26.7	22.3	16.7	13.4	11.1	8.9	6.7	1.53	1.02	0.77	0.61		
	VC	100	0.47	34.9	27.9	23.3	17.4	14.0	11.6	9.3	7.0	1.60	1.07	0.80	0.64		
	XC	40	0.40	29.7	23.8	19.8	14.9	11.9	9.9	7.9	5.9	1.36	0.91	0.68	0.55		
	XC	50	0.45	33.4	26.7	22.3	16.7	13.4	11.1	8.9	6.7	1.53	1.02	0.77	0.61		

Features	
Common Use	Weeds
Pattern	Off-Center Fan
Technology	Air Induction
Material	Ceramic
Spray Angle	80°
Pressure Range	40-100 PSI (3-7 BAR)
Configuration	Nozzle
Part Numbers	
Nozzles 80°	Caps (25 Pack)
AVI-OC-80015	CAP01-015
AVI-OC-8002	CAP01-02
AVI-OC-80025	CAP01-025
AVI-OC-8003	CAP01-03
AVI-OC-8004	CAP01-04

METRIC UNITS

Nozzle Size	Droplet Size 80°	Pressure (Bar)	Flow Rate (LPM)	Liters/Hectare 50cm Spacing											
				KM/H											
				4	5	6	7	8	9	10	12	14	16	18	20
015	VC	3	0.15	180	144	120	103	90	80	72	60	51	45	40	36
	VC	4	0.05	207	166	138	118	104	92	83	69	59	52	46	41
	VC	5	0.05	231	185	154	132	116	103	92	77	66	58	51	46
02	XC	3	0.20	240	192	160	137	120	107	96	80	69	60	53	48
	VC	4	0.06	273	218	182	156	137	121	109	91	78	68	61	55
	VC	5	0.07	309	247	206	177	155	137	124	103	88	77	9	62
025	XC	3	0.25	300	240	200	171	150	133	120	100	86	75	67	60
	VC	4	0.08	345	276	230	197	173	153	138	115	99	86	77	69
	VC	5	0.09	387	310	258	221	194	172	155	129	111	97	86	77
03	XC	3	0.30	360	288	240	206	180	160	144	120	103	90	80	92
	VC	4	0.09	417	334	278	238	209	185	167	139	119	104	93	83
	VC	5	0.11	465	372	310	266	233	207	186	155	133	116	103	93
04	XC	3	0.40	480	384	320	274	240	213	192	160	137	120	107	96
	VC	4	0.13	555	444	370	317	278	247	222	185	159	139	123	111
	VC	5	0.14	621	497	414	355	311	276	248	207	177	155	138	124

Albus® is a registered trademark of SAINT-GOBAIN SOLCERA, SAINT GOBAIN CERAMIQUES AVANCEES DESMARQUEST, CERAMIQUES TECHNIQUES DESMARQUEST, and SOCIETE DESMARQUEST ET CEC. Hypro® is a registered trademark of Pentair.

BOOMLESS FLAT FAN NOZZLES - XT-BOOM X TENDER



The XT introduces boomless spray technology, enabling spray to be targeted into places that conventional booms and other nozzles cannot reach. XT delivers a uniform spray pattern over a distance of up to 16 feet (4.9 m). Ideal for weed control in forests and pastureland.

- ◆ Ideal for applications where a conventional boom cannot be used due to obstacles
- ◆ Common uses include orchard, vineyard, forestry, pasture, turf and golf course spraying, as well as maintaining rights-of-way and fence rows
- ◆ Excellent low-drift option while extending spray reach
- ◆ Large droplet size reduces spray drift and promotes spray penetration
- ◆ Maintains a consistent spray swath over a pressure range of 30-60 psi (2-5 bar)
- ◆ Standard models with precision-molded polyacetal nozzle and threaded stainless steel body provide excellent durability and low maintenance

US UNITS

Nozzle Size (MNPT)	Pressure (PSI)	Flow Rate (GPM)	Gallons per Acre at swath shown								GAL/1000ft ²				Swath (Ft) at 40 PSI 48 in high
			MPH								2	3	4	5	
10 (1/4")	30	0.9	8.9	7.1	5.9	4.5	3.6	3.0	2.4	1.8	0.41	0.27	0.20	0.16	13
	40	1.0	9.9	7.9	6.6	5.0	4.0	3.3	2.6	2.0	0.45	0.30	0.23	0.18	
	50	1.1	10.9	8.7	7.3	5.4	4.4	3.6	2.9	2.2	0.50	0.33	0.25	0.20	
	60	1.2	11.9	9.5	7.9	5.9	4.8	4.0	3.2	2.4	0.55	0.36	0.27	0.22	
20 (1/4")	30	1.7	13.6	10.9	9.0	6.8	5.4	4.5	3.6	2.7	0.62	0.42	0.31	0.25	15
	40	2.0	16.0	12.8	10.6	8.0	6.4	5.3	4.3	3.2	0.73	0.49	0.37	0.29	
	50	2.2	17.6	14.1	11.7	8.8	7.0	5.9	4.7	3.5	0.81	0.54	0.40	0.32	
	60	2.4	19.2	15.3	12.8	9.6	7.7	6.4	5.1	3.8	0.88	0.59	0.44	0.35	
24 (1/4")	30	2.1	16.2	13.0	10.8	8.1	6.5	5.4	4.3	3.2	0.75	0.50	0.37	0.30	16
	40	2.4	18.6	14.9	12.4	9.3	7.4	6.2	5.0	3.7	0.85	0.57	0.43	0.34	
	50	2.7	20.9	16.7	13.9	10.4	8.4	7.0	5.6	4.2	0.96	0.64	0.48	0.38	
	60	2.9	22.4	17.9	15.0	11.2	9.0	7.5	6.0	4.5	1.03	0.69	0.51	0.41	
43 (3/8")	30	3.7	31.6	25.3	21.1	15.8	12.6	10.5	8.4	6.3	1.45	0.97	0.72	0.58	14
	40	4.3	36.7	29.4	24.5	18.3	14.7	12.2	9.8	7.3	1.68	1.12	0.84	0.67	
	50	4.8	41.0	32.8	27.3	20.5	16.4	13.7	10.9	8.2	1.88	1.25	0.94	0.75	
	60	5.3	45.2	36.2	30.2	22.6	18.1	15.1	12.1	9.0	2.08	1.38	1.04	0.83	
80 (1/2")	30	6.9	68.3	54.6	45.5	34.2	27.3	22.8	18.2	13.7	3.14	2.09	1.57	1.25	13
	40	8.0	79.2	63.4	52.8	39.6	31.7	26.4	21.1	15.8	3.64	2.42	1.82	1.45	
	50	8.9	88.1	70.5	58.7	44.1	35.2	29.4	23.5	17.6	4.04	2.70	2.02	1.62	
	60	9.8	97.0	77.6	64.7	48.5	38.8	32.3	25.9	19.4	4.45	2.97	2.23	1.78	
167 (3/4")	30	14.5	128	103	85.4	64.1	51.3	42.7	34.2	25.6	5.88	3.92	2.94	2.35	15
	40	16.7	148	118	98.4	73.8	59.0	49.2	39.4	29.5	6.78	4.52	3.39	2.71	
	50	18.7	165	132	110	82.6	66.1	55.1	44.1	33.1	7.59	5.06	3.79	3.03	
	60	20.5	181	145	121	90.6	72.5	60.4	48.3	36.2	8.32	5.54	4.16	3.33	
215 (3/4")	30	18.6	144	115	95.9	71.9	57.5	48.0	38.4	28.8	6.60	4.40	3.30	2.64	16
	40	21.5	166	133	111	83.1	66.5	55.4	44.3	33.3	7.63	5.09	3.82	3.05	
	50	24.0	186	149	124	92.8	74.3	61.9	49.5	37.1	8.52	5.68	4.26	3.41	
	60	26.3	203	163	136	102	81.4	67.8	54.2	40.7	9.34	6.22	4.67	3.73	

TYPICAL SPRAY PATTERN PRODUCED BY XT SERIES

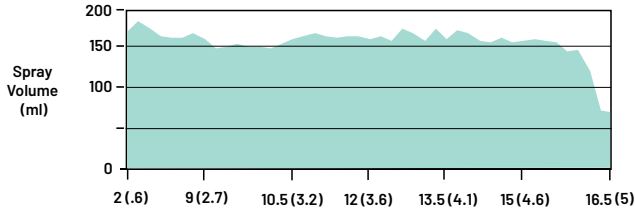

COMMON USES OF THE BOOM X TENDER SPRAY NOZZLES

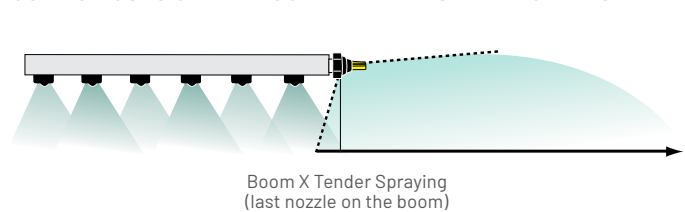

ADJUSTABLE SWATH WIDTH

Swath width can be increased or decreased by adjusting the angle of the nozzle +/- 18°.

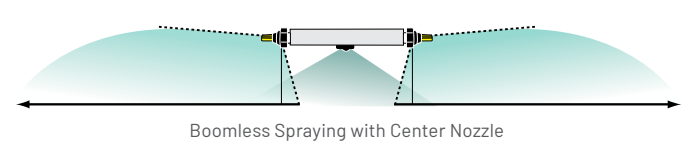
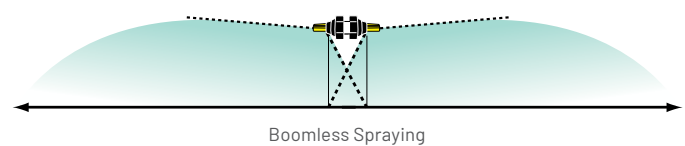
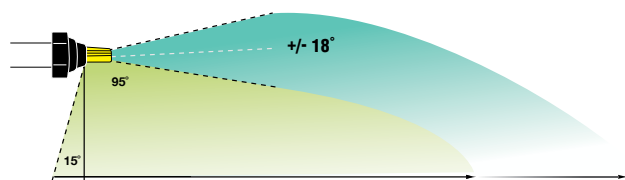

BOOMLESS FLAT FAN NOZZLES - XT-BOOM X TENDER



Boom X Tender nozzles are ideal for boomless spraying or as the last nozzle on a boom.



Hypro's Boom X Tender nozzles provide excellent coverage throughout the swath width for superior results.



Gasket, insert and o-ring kits available to rebuild MNPT versions.

METRIC UNITS

Nozzle Size (MNPT)	Pressure (BAR)	Flow Rate (LPM)	Application Rate L/Ha - at swath shown											Swath Width (M) @ 2.76 BAR 1.22 meters high
			KM/H											
			4	5	6	7	8	10	12	14	16	18	20	
10 (1/4 inch)	2	3.2	124	99	83	71	62	50	41	35	31	28	25	3.9
	3	3.9	152	121	101	87	76	61	51	43	38	34	30	
	4	4.6	175	140	117	100	88	70	58	50	44	39	35	
20 (1/4 inch)	2	6.4	201	161	134	115	101	81	67	58	50	45	40	4.8
	3	7.9	247	197	165	141	123	99	82	71	62	55	49	
	4	9.1	285	228	190	163	142	114	95	81	71	63	57	
24 (1/4 inch)	2	7.7	237	189	158	135	118	95	79	68	59	53	47	4.9
	3	9.5	290	232	193	166	145	116	97	83	73	64	58	
	4	10.9	335	268	223	191	167	134	112	96	84	74	67	
43 (3/8 inch)	2	13.9	473	378	315	270	236	189	158	135	118	105	95	4.4
	3	17	579	463	386	331	289	232	193	165	145	129	116	
	4	19.6	668	535	446	382	334	267	223	191	167	149	134	
80 (1/2 inch)	2	25.8	992	793	661	567	496	397	331	283	248	220	198	3.9
	3	31.6	1215	972	810	694	607	486	405	347	304	270	243	
	4	36.5	1403	1122	935	802	701	561	468	401	351	312	281	
167 (3/4 inch)	2	53.8	1878	1502	1252	1073	939	751	626	537	469	417	376	4.3
	3	65.9	2300	1840	1533	1314	1150	920	767	657	575	511	460	
	4	76.1	2656	2125	1771	1518	1328	1062	885	759	664	590	531	
215 (3/4 inch)	2	69.3	2122	1697	1414	1212	1061	849	707	606	530	471	424	4.9
	3	84.9	2598	2079	1732	1485	1299	1039	866	742	650	577	520	
	4	98	3000	2400	2000	1715	1500	1200	1000	857	750	667	600	

Swath widths and application rates in charts are based on height of 48 inches (1.2 metres), a different height will give different swath widths

Features	
Common Use	Weeds
Pattern	Boomless Fan
Technology	Pre-Orifice
Material	Stainless or Polyacetal
Spray Angle	105°
Pressure Range	30-60 PSI (2-5 BAR)
Configuration	MNPT & FastCap

Part Numbers		
FastCaps	MNPT (Thread)	Parts Kits for MNPT version
FC-XT010	XT010 (1/4")	XT010-GIOKIT
FC-XT020	XT020 (1/4")	XT020-GIOKIT
FC-XT024	XT024 (1/4")	XT024-GIOKIT
FC-XT043	XT043 (3/8")	XT043-GIOKIT
-	XT080 (1/2")	XT080-GIOKIT
-	XT167 (3/4")	XT167-GIOKIT
-	XT215 (3/4")	XT215-GIOKIT

Replacement FastCap Seal

10BG-2270-0150



Model	Description
9950-0033	Boom X Tender Tee/Swivel Kit for use with 1/4" NPT or Fastcap XT Nozzles

$$\text{GPM} = \frac{\text{GPA} \times \text{MPH} \times \text{swath width (in)}}{5,940}$$

$$\text{GPM} = \frac{\text{GPA} \times 5,940}{\text{MPH} \times \text{swath width (in)}}$$

$$\text{LPM} = \frac{\text{L/ha} \times \text{Kmph} \times \text{swath width (m)}}{600}$$

$$\text{L/ha} = \frac{\text{LPM} \times 600}{\text{Kmph} \times \text{swath width (m)}}$$

SUDDEN IMPACT

High Impact Car Wash Nozzle

**25% WATER SAVINGS!
5X'S THE LIFE!**



Sample Part Number: **TUR324B-2.0**

Breakdown:

TUR 324 B - 2.0
series material size
brass 2.0

- ◆ Provides a high impact, controlled rotation 0° water stream with much greater impact and cleaning efficiency than other nozzles which reduces wash time & increases thru-put
- ◆ Lasts up to five times longer than other rotating nozzles on the market, reducing operating costs over the life of the car wash
- ◆ Improved cleaning efficiency over other rotating nozzles reduces water consumption by up to 25%
- ◆ Tungsten carbide seat and nozzle provide unmatched wear and shatter resistance over ceramic material commonly utilized in other nozzles
- ◆ High strength, forged housing available in economical brass or corrosion-resistant 304 stainless steel
- ◆ Elastomer cover protects vehicles and nozzles
- ◆ Precision-machined bearing in rotor offers very high wear resistance and optimal impact
- ◆ Available with 24° pattern for maximum impact or 30° pattern for extra coverage
- ◆ BSP-style connection available in 24° brass (sizes 2.0, 3.5, 4.5) for use in Mark VII® washes

NOZZLE SPECIFICATIONS

Series	Pressure*	Ideal Impact Distance	Material	Angle	Temperature
TUR324B-x.x	1750 PSI (120 bar)	20"-30" (51-76cm)	Brass	24°	180° F (82° C)
TUR324B-x.x-BSP	1750 PSI (120 bar)	20"-30" (51-76cm)	Brass	24°	180° F (82° C)
TUR324S-x.x	3000 PSI (207 bar)	20"-30" (51-76cm)	Stainless	24°	180° F (82° C)
TUR330B-x.x	1300 PSI (90 bar)	15"-25" (38-63cm)	Brass	30°	180° F (82° C)
TUR330S-x.x	3000 PSI (207 bar)	15"-25" (38-63cm)	Stainless	30°	180° F (82° C)

*See rate chart below for specific information

DIMENSIONAL CHART

Series	A (in)	A (mm)	B (in)	B (mm)
324	3.05	77.5	1.49	37.8
330	2.96	75.6	1.69	42.9

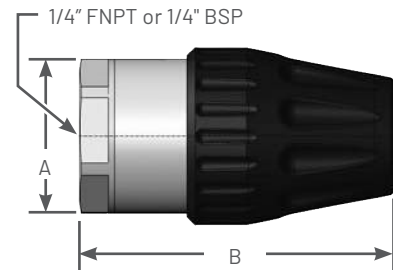

Spray Nozzle Size	Flow Rate (US GPM)											Flow Rate (L/min)										
	Pressure (PSI)											Pressure (BAR)										
	800	900	1000	1100	1200	1500	2000	2250	2500	2750	3000	50	60	70	80	90	100	120	140	160	180	200
2.0	0.89	0.95	1.00	1.05	1.10	1.22	1.41	1.50	1.58	1.66	1.73	3.21	3.51	3.80	4.06	4.30	4.54	4.97	5.37	5.74	6.09	6.42
3.0	1.34	1.42	1.50	1.57	1.64	1.84	2.12	2.25	2.37	2.49	2.60	4.83	5.29	5.71	6.11	6.48	6.83	7.48	8.08	8.64	9.16	9.66
3.5	1.57	1.66	1.75	1.84	1.92	2.14	2.47	2.63	2.77	2.90	3.03	5.66	6.20	6.70	7.16	7.59	8.00	8.77	9.47	10.10	10.70	11.30
4.0	1.79	1.90	2.00	2.10	2.19	2.45	2.83	3.00	3.16	3.32	3.46	6.45	7.07	7.63	8.16	8.66	9.12	9.99	10.80	11.50	12.20	12.90
4.5	2.01	2.13	2.25	2.36	2.46	2.76	3.18	3.38	3.56	3.73	3.90	7.24	7.94	8.57	9.16	9.72	10.20	11.20	12.10	12.90	13.70	14.40
5.0	2.24	2.37	2.50	2.62	2.74	3.06	3.54	3.75	3.95	4.15	4.33	8.07	8.84	9.55	10.20	10.80	11.40	12.50	13.50	14.40	15.30	16.10
5.5	2.46	2.61	2.75	2.88	3.01	3.37	3.89	4.13	4.35	4.56	4.76	8.87	9.71	10.40	11.20	11.80	12.50	13.70	14.80	15.80	16.80	17.70
6.0	2.68	2.85	3.00	3.15	3.29	3.67	4.24	4.50	4.74	4.97	5.20	9.66	10.50	11.40	12.20	12.90	13.60	14.90	16.10	17.20	18.30	19.30

SAMPLE PART NUMBER

TUR	3	24	B	-	2.0
Model	Size	Angle	Material	Dash	Nozzle Number
Turbo (NPT)	3	24° or 30°	"B" Brass or "S" Stainless	-	2.0, 3.0, 3.5, 4.0, 4.5, 5.0, 5.5, 6.0
Turbo (BSP) for Mark VII® Washes*	3	24°	"B" Brass	-	2.0, 3.5, 4.5

Note: BSP Models: Add suffix "BSP" -example TUR324B-2.0BSP

SPRAY IT MOBILE APP

SELECT THE RIGHT NOZZLE SIZED FOR YOUR APPLICATION

- ◆ Choose 'Select by Application' for a full list of nozzles that fit your application requirements
- ◆ Choose 'Select by Chemical' (US only) for a recommended nozzle family based on the chemical you are using
- ◆ Search for a specific nozzle or chemical directly from the home screen
- ◆ Integrated Where to Buy tool makes purchasing easy
- ◆ Available in US and Metric Units and multiple languages



Search 'Spray It' on the Apple Store or Android Market



PRESSURE TRANSDUCER

Reference Number	Part Number	Description
2520-0239	2530-0207	1/4" NPT thread, 0 - 100 psi, 1% accuracy, bluetooth connectivity to SprayIT App enables real time droplet size monitoring.
2520-0240	4201N-B104	Single outlet nozzle body
2520-0241	CAP10-20	1/4" npt threaded spray cap

SPRAY IT ONLINE CALCULATOR

The Spray It Calculator is an easy-to-use tool that will help you find the right spray nozzle for your desired application. Simply answer a few questions about your specific application and we'll supply you the best nozzles for that application.

This tool is available on the Hypro website or as a mobile app available for both Apple and Android devices.

SPRAYIT.HYPROSPRAYTIPS.COM



HP-HIGH PRESSURE NOZZLE

Hardened Stainless Steel



- ◆ Achieves up to 16%* greater impact than competitive high pressure nozzles, making them the best value on the market today
- ◆ Hardened 416 stainless steel, the industry standard for long-life
- ◆ Reliable performance in high pressure applications up to 4000 psi (276 BAR)
- ◆ High impact spray in a tightly formed fan pattern
- ◆ Consistent, even distribution provides uniform cleaning without overlapping
- ◆ Protected outlet design guards the orifice during installation and use
- ◆ Versatile 1/4" and 1/8" NPT connections suit a variety of applications
- ◆ Comes in spray angles of 0°, 5°, 15°, 25°, 40°
- ◆ Improved marking for easy identification and replacement

*Commissioned with an independent tester

AVAILABLE SPRAY ANGLES**

In Stock Available Contact Factory

Sample Part Number: HP 1/4-2504

Degree	Size													
	02	03	035	04	045	05	055	06	065	07	075	08	085	09
1/8" NPT	0°	X	X	X	X	X	X	X	X	X	X	X		
	5°	X			X		X		X					
	15°	X	X	X	X	X	X	X	X	X	X	X	X	
	25°	X	X	X	X	X	X	X	X	X	X	X	X	
	40°	X	X	X	X	X	X	X	X	X	X	X	X	
1/4" NPT	0°	X	X	X	X	X	X	X	X	X	X	X		
	5°			X			X					X		X
	15°	X	X	X	X	X	X	X	X	X	X	X	X	
	25°	X	X	X	X	X	X	X	X	X	X	X	X	
	40°	X	X	X	X	X	X	X	X	X	X	X	X	

Breakdown:

HP	1/4	-	25	04
model	connection		spray angle	size
HP	1/4" NPT		25°	04

**For additional sizes, please contact Technical/Applications at 1-800-445-8360

US UNITS

Spray Nozzle Size	1/8" NPT	1/4" NPT	Flow Rate (US GPM)													
			Pressure (PSI)													
			300	400	500	600	700	800	1000	1250	1500	2000	2500	3000	3500	4000
02	X	X	0.55	0.63	0.71	0.77	0.84	0.89	1.00	1.12	1.22	1.41	1.58	1.73	1.87	2.00
03	X	X	0.82	0.95	1.60	1.16	1.25	1.34	1.50	1.68	1.84	2.12	2.37	2.06	2.81	3.00
035	X	X	0.96	1.11	1.24	1.36	1.46	1.57	1.75	1.96	2.14	2.47	2.77	3.03	3.27	3.50
04	X	X	1.10	1.26	1.41	1.55	1.67	1.79	2.00	2.24	2.45	2.83	3.16	3.46	3.74	4.00
045	X	X	1.23	1.42	1.59	1.74	1.88	2.01	2.25	2.52	2.76	3.18	3.56	3.90	4.21	4.50
05	X	X	1.37	1.58	1.77	1.94	2.09	2.24	2.50	2.80	3.06	3.54	3.95	4.33	4.68	5.00
055	X	X	1.51	1.74	1.94	2.13	2.30	2.46	2.75	3.07	3.37	3.89	4.35	4.76	5.14	5.50
06	X	X	1.64	1.90	2.12	2.32	2.51	2.68	3.00	3.35	3.67	4.24	4.74	5.20	5.61	6.00
065	X	X	1.78	2.06	2.30	2.52	2.72	2.91	3.25	3.68	3.98	4.60	5.14	5.63	6.08	6.50
07	X	X	1.92	2.21	2.47	2.71	2.93	3.13	3.50	3.91	4.29	4.95	5.53	6.06	6.55	7.00
075	X	X	2.05	2.37	2.65	2.90	3.14	3.35	3.75	4.19	4.59	5.30	5.93	6.50	7.02	7.50
08	X	X	2.19	2.53	2.83	3.10	3.35	3.58	4.00	4.47	4.90	5.66	6.32	6.93	7.48	8.00
085	X		2.33	2.69	3.01	3.29	3.56	3.80	4.25	4.75	5.21	6.01	6.72	7.36	7.95	8.50
09		X	2.46	2.85	3.18	3.49	3.76	4.02	4.50	5.03	5.51	6.36	7.12	7.79	8.42	9.00

METRIC UNITS

Spray Nozzle Size	1/8" NPT	1/4" NPT	Flow Rate (L/min)													
			Pressure (BAR)													
			15	20	30	40	50	60	70	80	100	150	200			
02	X	X	1.77	2.04	2.50	2.88	3.22	3.53	3.81	4.08	4.56	5.58	6.45			
03	X	X	2.65	3.06	3.75	4.32	4.84	5.30	5.72	6.12	6.84	8.38	9.67			
035	X	X	3.09	3.57	4.37	5.05	5.64	6.18	6.67	7.14	7.98	9.77	11.20			
04	X	X	3.53	4.08	4.99	5.77	6.45	7.06	7.63	8.16	9.12	11.10	12.80			
045	X	X	3.97	4.59	5.62	6.49	7.25	7.95	8.58	9.17	10.20	12.50	14.50			
05	X	X	4.41	5.10	6.24	7.21	8.06	8.83	9.54	10.10	11.40	13.90	16.10			
055	X	X	4.86	5.61	6.87	7.93	8.86	9.71	10.40	11.20	12.50	15.30	17.70			
06	X	X	5.30	6.12	7.49	8.65	9.67	10.50	11.40	12.20	13.60	16.70	19.30			
065	X	X	5.74	6.63	8.12	9.37	10.40	11.40	12.40	13.20	14.80	18.10	20.90			
07	X	X	6.18	7.14	8.74	10.00	11.20	12.30	13.30	14.20	15.90	19.50	22.50			
075	X	X	6.62	7.65	9.36	10.80	12.00	13.20	14.30	15.20	17.10	20.90	24.10			
08	X	X	7.06	8.16	9.99	11.50	12.80	14.10	15.20	16.30	18.20	22.30	25.70			
085	X		7.50	8.66	10.60	12.20	13.70	15.00	16.20	17.30	19.30	23.70	27.40			
09		X	7.95	9.17	11.20	12.90	14.50	15.80	17.10	18.30	20.50	25.10	29.00			

FP-FULCOJET™ FULL CONE NOZZLE



- ◆ Precision-molded orifice provides accurate and consistent full cone spray pattern
- ◆ Widely used 1/8" and 1/4" NPT or 1/8" and 1/4" BSP connections
- ◆ Available in a variety of standard flow and cone angle options to fit application requirements
- ◆ Color coded by flow rate to simplify nozzle installation and replacement
- ◆ Excellent wear and chemically-resistant Solef® Polyvinylidene Fluoride (PVDF) polymer
- ◆ Ideal for low pressure rinsing, washing, coating, cooling, and additive application

US UNITS

Nozzle	Thread	Color	Cone Angle @ 15 PSI	Flow Rate (Gallons per Minute) of Water at 68°F												
				Pressure (PSI)												
				10	20	30	40	50	60	70	80	90	100	125	150	
90A1FP1.0	1/8" NPT	Orange	45°	0.10	0.14	0.16	0.19	0.21	0.22	0.24	0.25	0.27	0.28	0.31	0.34	
90A1FP1.5	1/8" NPT	Red	55°	0.15	0.20	0.25	0.28	0.31	0.34	0.36	0.38	0.40	0.42	0.47	0.51	
90A1FP2.0	1/8" NPT	Light Blue	60°	0.20	0.27	0.33	0.37	0.41	0.45	0.48	0.51	0.54	0.56	0.62	0.68	
90A1FP3.0	1/8" NPT	Lime Green	50°	0.30	0.41	0.49	0.56	0.62	0.67	0.72	0.76	0.81	0.85	0.93	1.01	
90A1FP3.5	1/8" NPT	Terracotta	60°	0.35	0.48	0.57	0.65	0.72	0.78	0.84	0.89	0.94	0.99	1.09	1.18	
90A1FP5.0	1/8" NPT	Blue	80°	0.50	0.68	0.82	0.93	1.03	1.12	1.20	1.27	1.34	1.41	1.56	1.69	
90A2FP6.5	1/4" NPT	Purple	50°	0.65	0.89	1.07	1.21	1.34	1.46	1.56	1.66	1.75	1.83	2.03	2.20	
90A2FP10	1/4" NPT	Olive Green	70°	1.00	1.37	1.64	1.87	2.06	2.24	2.40	2.55	2.69	2.82	3.12	3.38	

Sample Part Number: 90A1FP2.0

Breakdown:

material	thread	family	nozzle size
90 = PVDF	A1 = 1/8" NPT A2 = 1/4" NPT	FP	see table
	B1 = 1/8" BSP B2 = 1/4" BSP		

METRIC UNITS

Nozzle	Thread	Color	Cone Angle @ 1 Bar	Flow Rate (L/min) of Water at 20°C									
				Pressure (BAR)									
				0.5	1	2	3	4	5	7	10		
90B1FP1	1/8" BSP	Orange	45°	0.32	0.46	0.64	0.79	0.91	1.02	1.21	1.44		
90B1FP1.3W	1/8" BSP	Natural	90°	0.42	0.59	0.84	1.03	1.19	1.33	1.57	1.87		
90B1FP1.5	1/8" BSP	Red	55°	0.48	0.68	0.97	1.18	1.37	1.53	1.81	2.16		
90B1FP2	1/8" BSP	Light Blue	60°	0.64	0.91	1.29	1.58	1.82	2.04	2.41	2.88		
90B1FP2W	1/8" BSP	Light Blue	90°	0.64	0.91	1.29	1.58	1.82	2.04	2.41	2.88		
90B1FP3	1/8" BSP	Lime Green	50°	0.97	1.37	1.93	2.37	2.74	3.06	3.62	4.32		
90B1FP3.5	1/8" BSP	Terracotta	60°	1.13	1.60	2.26	2.76	3.19	3.57	4.22	5.05		
90B1FP3.7W	1/8" BSP	Gray	120°	1.19	1.69	2.39	2.92	3.37	3.77	4.46	5.33		
90B1FP5	1/8" BSP	Blue	80°	1.61	2.28	3.22	3.95	4.56	5.10	6.03	7.21		
90B2FP6.5	1/4" BSP	Purple	50°	2.10	2.96	4.19	5.13	5.93	6.63	7.84	9.37		
90B2FP10	1/4" BSP	Olive Green	70°	3.22	4.56	6.45	7.90	9.12	10.1	12.0	14.4		

FANJET™ - FLAT FAN PVDF NOZZLE



- ◆ Most popular selling nozzle for lower pressure car wash applications
- ◆ Chemically-resistant Polyvinylidene Fluoride (PVDF) polymer
- ◆ Pressures up to 500 PSI
- ◆ Available spray angles: 0°, 15°, 25°, 40°, 65°, 80°, 110°
- ◆ One-piece male 1/4" NPT and 1/4" or 1/8" BSP
- ◆ Hex body prevents distortion of the orifice and provides quick and easy installation
- ◆ Part number is molded into front of nozzle

AVAILABLE SPRAY ANGLES*

Available Contact Factory

Sample Part Number: **90A2CM04E80**

Degree	Size															
	01	015	02	025	03	04	05	06	07	08	10	15	20	30	40	50
1/4" NPT	0°			X		X	X	X	X	X		X	X	X		
	25°	X	X	X		X	X	X	X	X	X	X	X	X		
	40°	X	X	X		X	X	X	X	X	X	X	X	X	X	
	65°	X	X	X	X	X	X	X	X	X	X	X	X	X	X	X
	80°	X	X	X		X	X	X	X		X	X	X	X	X	

Breakdown:

90	A2	CM	04	E	80
material	thread	model	nozzle size	pattern even fan	fan angle degrees
90 = PVDF	A1 = 1/8" NPT A1 = 1/8" NPT B1 = 1/8" BSP B2 = 1/4" BSP	NPT			

*For additional sizes, please contact Technical/Applications at 1-800-445-8360

Spray Nozzle Size	Color	Flow Rate, (US GPM)											
		Pressure (PSI)											
		30	40	50	60	70	80	100	150	200	300	400	500
01	Gray	0.09	0.10	0.11	0.12	0.13	0.14	0.16	0.19	0.22	0.27	0.32	0.35
015	Gray	0.13	0.15	0.17	0.18	0.20	0.21	0.24	0.29	0.34	0.41	0.47	0.53
02	Gray	0.17	0.20	0.22	0.24	0.26	0.28	0.32	0.39	0.45	0.55	0.63	0.71
025	Gray	0.22	0.25	0.28	0.31	0.33	0.35	0.40	0.48	0.56	0.68	0.79	0.88
03	Gray	0.26	0.30	0.34	0.37	0.40	0.42	0.47	0.58	0.67	0.82	0.95	1.06
04	Gray	0.35	0.40	0.45	0.49	0.53	0.57	0.63	0.77	0.89	1.10	1.26	1.41
05	Gray	0.43	0.50	0.56	0.61	0.66	0.71	0.79	0.97	1.12	1.37	1.58	1.77
06	Gray	0.52	0.60	0.67	0.73	0.79	0.85	0.95	1.16	1.34	1.64	1.90	2.12
07	Gray	0.61	0.70	0.78	0.86	0.93	0.99	1.11	1.36	1.57	1.92	2.21	2.47
08	Gray	0.69	0.80	0.89	0.98	1.06	1.13	1.26	1.55	1.79	2.19	2.53	2.83
10	Gray	0.87	1.00	1.12	1.22	1.32	1.41	1.58	1.94	2.24	2.74	3.16	3.54
15	Gray	1.30	1.50	1.68	1.84	1.98	2.12	2.37	2.90	3.35	4.11	4.74	5.30
20	Gray	1.73	2.00	2.24	2.45	2.65	2.83	3.16	3.87	4.47	5.48	6.32	7.07
30	Gray	2.60	3.00	3.35	3.67	3.97	4.24	4.74	5.81	6.71	8.22	9.49	10.61
40	Gray	3.46	4.00	4.47	4.90	5.29	5.66	6.32	7.75	8.94	10.95	12.65	14.14
50	Gray	4.33	5.00	5.59	6.12	6.61	7.07	7.91	9.68	11.18	13.69	15.81	17.68

Spray Nozzle Size	Color	Flow rate, (L/min)						
		Pressure (BAR)						
		0.5	1	2	3	4	5	7
02	Gray	0.33	0.46	0.65	0.80	0.92	1.03	1.22
03	Gray	0.49	0.69	0.98	1.20	1.39	1.55	1.83
04	Gray	0.65	0.92	1.31	1.60	1.85	2.07	2.44
05	Gray	0.82	1.15	1.63	2.00	2.31	2.58	3.06
06	Gray	0.98	1.39	1.96	2.40	2.77	3.10	3.67
08	Gray	1.31	1.85	2.61	3.20	3.70	4.13	4.89
10	Gray	1.63	2.31	3.27	4.00	4.62	5.16	6.11
15	Gray	2.45	3.46	4.90	6.00	6.93	7.75	9.17
20	Gray	3.27	4.62	6.53	8.00	9.24	10.3	12.2
30	Gray	4.90	6.93	9.80	12.0	13.8	15.4	18.3
40	Gray	6.53	9.24	13.0	16.0	18.4	20.6	24.4
50	Gray	8.16	11.5	16.3	20.0	23.0	25.8	30.5

PVDF CM nozzles can also be ordered in colours. Minimum order quantity is 1000 nozzles.

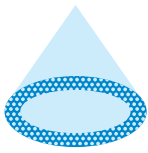

MISTING NOZZLES - F, PF, AFD, AF, HAF



The Hypro® range of misting nozzles produce a high percentage of droplets smaller than 50 microns making the sprays suitable for humidification and evaporative cooling. They are chemically resistant to also allow use with pesticides, disinfectants, and odor control agents as well as dust suppression.

- ◆ A variety of connection options match most applications
- ◆ Corrosion-resistant construction
- ◆ Strainers are included on many models to extend service life
- ◆ Anti-drip checks are standard in PF and AFD models

FLANGED NOZZLES: F-FLAT FAN



Part Number (Nozzle Only)	Color	Spray Angle	US gal/hr @ pressure (PSI)					L/hr@ pressure (bar)				
			40	60	75	100	150	3	4	6	8	10
F65-005	White	65	2.89	3.54	3.96	4.57	5.60	11.59	13.38	16.39	18.93	21.16
F80-0067	Olive Green	80	4.00	4.90	5.48	6.32	7.75	16.04	18.52	22.68	26.19	29.28

Features	
Common Use	Cooling & Humidification
Pattern	Fan or Hollow Cone
Technology	Elliptical Orifice or Swirl
Material	Polyacetal
Spray Angle	65-110°
Pressure Range	40-150 PSI (3-10 BAR)
Configuration	Nozzles, Push-fit, or MNPT

RETAINING NUTS FOR FLANGED TIPS



Part Number	Description
251032WH	3/8 inch BSP Retaining Nut White Polypropylene
251032GY	3/8 inch BSP Retaining Nut Gray Polypropylene
251032BL	3/8 inch BSP Retaining Nut Black Polypropylene

PUSH-FIT ANTI-DRIP NOZZLE: PF-HOLLOW CONE 3/8"



Part Number w/ Cup Strainer	Color	Spray Angle	US gal/hr @ pressure (PSI)					L/hr@ pressure (bar)				
			40	60	75	100	150	3	4	6	8	10
30PFAF013-105	White	105	1.27	1.56	1.74	2.01	2.46	5.09	5.88	7.20	8.31	9.29
30PFAF013-105BL	Black	105	1.27	1.56	1.74	2.01	2.46	5.09	5.88	7.20	8.31	9.29

1



2



3



MISTING NOZZLE ACCESSORIES FOR PUSH-FIT ANTI-DRIP NOZZLES

Reference Number	Part Number	Description
1	3219503269	Push-in Porous Plastic 250 Mesh Post Filter
2	141418	Barbed Tee 1/8 inch FNPT x 1/4 inch Barbs Black (6 mm)
2	383818	Barbed Tee 1/8 inch FNPT x 3/8 inch Barbs Black (6 mm)
3	1212S18	Push-in Tee 1/2 inch SLIP x 1/2 inch SLIP x 1/8 inch (F)

MISTING NOZZLES - F, PF, AFD, AF, HAF

1/8" MNPT ANTI-DRIP NOZZLE: AFD-HOLLOW CONE



Color	Spray Angle	US gal/hr @ pressure (PSI)					L/hr @ pressure (bar)					Part Number Nozzle Only	Part Number with Cup Strainer
		40	60	75	100	150	3	4	6	8	10		
Gray	80	0.72	0.88	0.99	1.14	1.39	2.76	3.19	3.91	4.51	5.05	301AFD0.7-80	CS301AFD0.7-80
Cream	105	1.20	1.47	1.64	1.90	2.32	4.74	5.47	6.70	7.74	8.65	301AFD1.2-105	CS301AFD1.2-105
Blue	100	1.68	2.06	2.30	2.66	3.25	6.32	7.29	8.93	10.32	11.53	301AFD1.6-100	-

1/8" MNPT NOZZLE: AF-HOLLOW CONE



Color	Spray Angle	US gal/hr @ pressure (PSI)					L/hr @ pressure (bar)					Part Number Nozzle Only	Part Number with SS Cup Strainer	Part Number with SS Post Strainer	Part Number with Plastic Filter
		40	60	75	100	150	3	4	6	8	10				
White	65	0.48	0.59	0.66	0.76	0.93	1.58	1.82	2.23	2.58	2.88	301AF0.4-65	CS301AF0.4-65	301AFUSA0.5	PP301AF0.4-65
Gray	80	0.72	0.88	0.99	1.14	1.39	2.76	3.19	3.91	4.51	5.05	301AF0.7-80	CS301AF0.7-80	301AFUSA1.0	PP301AF0.7-80
White	80	0.72	0.88	0.99	1.14	1.39	2.76	3.19	3.91	4.51	5.05	301AF0.7-80W	CS301MNF-W	301MNF-W	PP301AF0.7-80W
Cream	105	1.20	1.47	1.64	1.90	2.32	4.74	5.47	6.70	7.74	8.65	301AF1.2-105C	CS301AF1.2-105C	301AFUSA2.0	PP301AF1.2-105C
Blue	100	1.68	2.06	2.30	2.66	3.25	6.32	7.29	8.93	10.32	11.53	301AF1.6-100	CS301AF1.6-100	301AFUSA3.0	PP301AF1.6-100
Yellow	70	5.00	6.12	6.85	7.91	9.68	10.26	11.85	14.51	16.76	18.74	301AF5.0-70	-	-	-

FLANGED NOZZLES: HAF-HOLLOW CONE



Part Number Nozzle Only	Color	Spray Angle	US gal/hr @ pressure (PSI)					L/hr @ pressure (bar)				
			40	60	75	100	150	3	4	6	8	10
30HAF01110	White	110	1.00	1.22	1.37	1.58	1.94	4.01	4.63	5.67	6.55	7.32
30HAF01-65	Cream	65	1.00	1.22	1.37	1.58	1.94	4.01	4.63	5.67	6.55	7.32
30HAF01480	Mint Green	80	1.43	1.75	1.96	2.26	2.77	5.73	6.62	8.10	9.36	10.46
30HAF01570	White	70	1.51	1.85	2.07	2.39	2.92	6.05	6.99	8.56	9.88	11.05



MISTING NOZZLE ACCESSORIES FOR 1/8" MNPT NOZZLE

Reference Number	Part Number	Description
1	32100200	Cup Strainer 200 Mesh (Fits Rear of Threaded Misting Nozzles)
2	32PIFA250	Push-in 200 Mesh Post Strainer
3	27101612	3/8 inch BSP x 1/2 inch Wet Boom Body

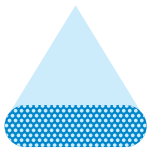

FLAT FAN SPRAY NOZZLES - EVEN 80°

For Knapsack/Backpack Sprayers



The Hypro Even Flat Fan spray nozzle creates a consistent pattern that is ideal for single nozzle applications.

- ◆ Commonly used with knapsack sprayers for precise control
- ◆ 80° angle distributes a medium fine spray evenly across the swath
- ◆ Mixed droplet spectrum is ideal for all targets
- ◆ One piece design

Nozzle Size	Droplet Size	Spray Angle	Spray Width 20 in height (in)	Pressure (PSI)	Flow Rate (GPM)	Gallons per Acre (Single Nozzle Applications)			
						MPH			
						1	2	3	4
01	F	80	34	20.0	0.086	15.3	7.6	5.1	3.8
	F					17.3	8.7	5.8	4.3
	F					18.7	9.4	6.2	4.7
015	F	80	34	20.0	0.129	22.9	11.5	7.6	5.7
	F					25.7	12.9	8.6	6.4
	F					28.1	14.0	9.4	7.0
02	M	80	34	20.0	0.173	30.5	15.3	10.2	7.6
	F					34.1	17.1	11.4	8.5
	F					37.4	18.7	12.5	9.4
03	M	80	34	20.0	0.259	45.8	22.9	15.3	11.5
	M					51.4	25.7	17.1	12.9
	F					56.1	28.1	18.7	14.0

Droplet size based on ASABE S572.1 standard.

Application rates shown reflect single nozzle applications at walking speeds.

Features	
Common Use	Knapsack
Pattern	Even Flat Fan
Technology	Elliptical Orifice
Material	Polyacetal
Spray Angle	80°
Pressure Range	20-40 PSI (2-3 BAR)
Configuration	Nozzle
Part Numbers (Bags of 10)	
Nozzles 80°	Caps (25 Pack)
E80-01	CAP00-01
E80-015	CAP00-015
E80-02	CAP00-02
E80-03	CAP00-03

Nozzle Size	Droplet Size	Spray Angle	Spray Width 50 cm height (m)	Pressure (BAR)	Flow Rate (LPM)	Application Rate L/ha (Single Nozzle Applications)			
						KM/H			
						2	3	4	5
01	F	80	0.8	2	0.327	117	78	58	47
	F					132	88	66	53
	F					143	95	72	57
015	F	80	0.8	2	0.490	175	117	88	70
	F					197	131	98	79
	F					215	143	107	86
02	M	80	0.8	2	0.653	234	156	117	93
	F					261	174	130	104
	F					286	191	143	114
03	M	80	0.8	2	0.980	350	234	175	140
	M					393	262	197	157
	F					429	286	215	172

Droplet size based on ASABE S572.1 standard.

Application rates shown reflect single nozzle applications at walking speeds.

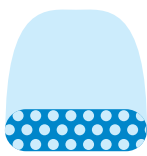

DEFLECTIP AND POLIJET 53°-127°

For Knapsack/Backpack Sprayers



The DeflecTip and PoliJet wide-angle flood fan nozzle creates a wide pattern at very low pressures while creating mainly medium and coarse droplets. It is well suited for sprayers using very low pressures, including manual sprayers.

- ◆ Different spray angles offer a choice of swath widths
- ◆ PoliJet nozzles are designed for knapsack applications, giving a low drift, course, even spray
- ◆ Circular orifice reduces the chances of blocking

US UNITS: DEFLECTIP

Nozzle Size	Droplet Size	Spray Angle	Spray Width 15 in height (in)	Pressure (PSI)	Flow Rate (GPM)	Gallons per Acre (Single Nozzle Application)			
						MPH			
						1	2	3	4
DT0.5	C	72°	23	15	0.05	73.3	48.5	36.7	29.2
	M	82°	27	22	0.06	74.6	49.7	37.3	29.8
	F	89°	31	30	0.07	76.4	51.0	38.5	30.4
DT0.75	VC	85°	28	15	0.07	87.0	57.8	43.5	34.8
	M	93°	33	22	0.09	92.6	61.5	46.6	37.3
	M	100°	37	30	0.11	94.4	62.8	47.2	37.9
DT1.0	M	100°	37	15	0.10	88.9	59.7	44.7	35.4
	M	108°	43	22	0.12	94.4	62.8	47.2	37.9
	M	112°	47	30	0.14	101.3	67.7	51.0	40.4
DT1.5	M	105°	41	1	0.15	122.4	81.4	60.9	49.1
	M	111°	46	1.5	0.18	134.2	89.5	67.1	53.4
	M	114°	48	2	0.21	146.6	97.6	73.3	58.4

Droplet size is based on ASABE S572.1 standard.

METRIC UNITS: DEFLECTIP

Nozzle Size	Droplet Size	Spray Angle	Spray Width 40 cm height (m)	Pressure (BAR)	Flow Rate (LPM)	Application Rate L/ha (Single Nozzle Application)			
						KM/H			
						2	3	4	5
DT0.5	C	72°	0.58	1	0.23	118	78	59	47
	M	82°	0.70	1.5	0.28	120	80	60	48
	F	89°	0.79	2	0.32	123	82	62	49
DT0.75	VC	85°	0.73	1	0.34	140	93	70	56
	M	93°	0.84	1.5	0.42	149	99	75	60
	M	100°	0.95	2	0.48	152	101	76	61
DT1.0	M	100°	0.95	1	0.46	143	96	72	57
	M	108°	1.10	1.5	0.56	152	101	76	61
	M	112°	1.19	2	0.64	163	109	82	65
DT1.5	M	105°	1.04	1	0.68	197	131	98	79
	M	111°	1.16	1.5	0.84	216	144	108	86
	M	114°	1.23	2	0.97	236	157	118	94

Droplet size is based on ASABE S572.1 standard.

US UNITS: POLIJET

Nozzle Size	ASABE Droplet Size	Spray Angle	Spray Width 20 in height (in)	Pressure (PSI)	Flow Rate (GPM)	Gallons per Acre (Single Nozzle Application)			
						MPH			
						1	2	3	4
AN0.6	C	53°	20 @ 40 PSI	10.0	0.16	47.2	23.6	15.7	11.8
	M			20.0	0.22	66.7	33.4	22.2	16.7
	M			40.0	0.27	81.7	40.9	27.2	20.4
AN1.2	C	90°	40 @ 40 PSI	10.0	0.32	47.0	23.5	15.7	11.8
	M			20.0	0.45	66.5	33.3	22.2	16.6
	M			40.0	0.55	81.5	40.7	27.2	20.4
AN1.8	C	113°	60 @ 40 PSI	10.0	0.48	47.2	23.6	15.7	11.8
	C			20.0	0.67	66.7	33.3	22.2	16.7
	C			40.0	0.82	81.7	40.8	27.2	20.4
AN2.4	C	127°	80 @ 40 PSI	10.0	0.63	46.9	23.5	15.6	11.7
	C			20.0	0.90	66.3	33.2	22.1	16.6
	C			40.0	1.10	81.3	40.6	27.1	20.3

Droplet size is based on ASABE S572.1 standard.

METRIC UNITS: POLIJET

Nozzle Size	BCPC Droplet Size	Spray Angle	Spray Width 50 cm height (m)	Pressure (BAR)	Flow Rate (LPM)	Application Rate L/ha (Single Nozzle Application)			
						KM/H			
						2	3	4	5
AN0.6	C	53°	0.5 @ 3 BAR	1	0.60	361	241	181	144
	M			2	0.85	511	340	255	204
	M			3	1.04	625	417	313	250
AN1.2	C	90°	1.0 @ 3 BAR	1	1.20	360	240	180	144
	M			2	1.70	509	339	255	204
	M			3	2.08	624	416	312	249
AN1.8	C	113°	1.5 @ 3 BAR	1	1.80	361	241	180	144
	C			2	2.55	510	340	255	204
	C			3	3.12	625	417	312	250
AN2.4	C	127°	2.0 @ 3 BAR	1	2.40	359	239	179	144
	C			2	3.39	508	338	254	203
	C			3	4.16	622	415	312	249

BCPC CODING FINE MEDIUM COARSE

BCPC droplet size based on BCPC standard.

Application rates shown reflect single nozzle applications at walking speeds.

Features	
Common Use	Knapsack
Pattern	Flood
Technology	Deflection
Material	Polyacetal
Spray Angle	53°-142°
Pressure Range	15-45 PSI(1-2 BAR)
Configuration	Nozzle

DT Part Numbers (Bags of 10)	
Nozzles	Caps (25 Pack)
30DT0.5	CAP30-20
30DT0.75	CAP30-20
30DT1.0	CAP30-20
30DT1.5	CAP30-20

AN Part Numbers	
Nozzles	Caps (25 Pack)
30AN0.6	CAP30-20
30AN01.2	CAP30-20
30AN01.8	CAP30-20
30AN02.4	CAP30-20

SPRAY NOZZLE CAPS AND ADAPTERS



Hypro® caps provide trouble-free spray nozzle installation and sealing on Hypro ProFlo nozzle bodies and several other common makes.

- ◆ Color-coded to ISO standards for nozzle flow to simplify nozzle selection and identification in the field
- ◆ Available in configurations optimized to fit a variety of spray nozzle geometries
- ◆ Caps for fan pattern nozzles automatically align nozzles for enhanced spray uniformity



	ISO Standard Fan	SnapLock ISO Standard Fan	Hardi®	Deflect Nozzle No-offset	European Fan (Thick body)	Standard Round (Non-aligning)	Albuz® Round (Thick flange)	Shut-off	Threaded	
Fits:	ULD, 3D, GA, LD, VP, TR, OC, F, E, AXI, ADI, OCI	ULD, 3D, GA, LD, VP, TR, OC, F, E, AXI, ADI, OCI	ULD, GA, LD, VP, TR, OC, F, E, AXI, ADI, OCI	DT, PoliJet	AVI, AVI-TWIN, ESI, APG, APE	HCX, FCX DC/CR, HAF, APM flanged hose barbs	Ceramic Disc, ATR, HCA, TVI	Blank	1/4" FNPT	Std. Pack
Black	CAP00-20	CAP11-20	16842490	CAP30-20	CAP01-20	CAP04-20	CAP05-20 3002603-20	CAP09-20	CAP10-20	10
Orange	CAP00-01	CAP11-01	-	-	CAP01-01	CAP04-01	CAP05-01	-	-	10
Green	CAP00-015	CAP11-015	-	-	CAP01-015	CAP04-015	CAP05-015	-	-	10
Yellow	CAP00-02	CAP11-02	-	-	CAP01-02	CAP04-02	CAP05-02	-	-	10
Lilac	CAP00-025	CAP11-025	-	-	CAP01-025	CAP04-025	CAP05-025	-	-	10
Blue	CAP00-03	CAP11-03	-	-	CAP01-03	CAP04-03	CAP05-03	-	-	10
Brown Red	CAP00-035	CAP11-035	-	-	-	-	-	-	-	10
Red	CAP00-04	CAP11-04	-	-	CAP01-04	CAP04-04	CAP05-04	-	-	10
Brown	CAP00-05	CAP11-05	-	-	CAP01-05	CAP04-05	CAP05-05	-	-	10
Gray	CAP00-06	CAP11-06	-	-	CAP01-06	CAP04-06	CAP05-06	-	-	10
White	CAP00-08	CAP11-08	-	-	CAP01-08	CAP04-08	CAP05-08	-	-	10
Light Blue	CAP00-10	CAP11-10	-	-	CAP01-10	CAP04-10	-	-	-	10
Lime Green	CAP00-15	CAP11-15	-	-	CAP01-15	CAP04-15	-	-	-	10
Included EPDM seal	10BG-2270-0150	10BG-2270-0150	16842491	10BG-2270-0150	-	-	-	-	-	-
Included EPDM o-ring	-	-	-	-	-	-	402105-030	-	-	-
Included Nitrile seal	-	-	-	-	-	-	-	65-BS205	-	-

Available for order through HYPRO-EU only (Cambridge, UK)

PUSH-TO-CONNECT SPRAY CAPS

Push-to-Connect (PTC) Cap Part Numbers			Gasket Type	Gasket part Number
Size	25 Std. Pack	1 Per Bag		
5/16"	4200-0082	BG-4200-0082	Std	10BG-2270-0150
5/16"	4200-0083	BG-4200-0083	Split	10BG-1700-0255
1/4"	4200-0060	BG-4200-0060	Std	10BG-2270-0150
3/8"	4200-0061	BG-4200-0061	Std	10BG-2270-0150
1/4"	4200-0062	BG-4200-0062	Split	10BG-1700-0255
3/8"	4200-0063	BG-4200-0063	Split	10BG-1700-0255



ELBOW AND DOUBLE ADAPTERS FOR SPRAY NOZZLE CAP

Part number	Description
4200N-0017	45 Double w/ Gasket
4200N-0018	90 Elbow w/ Gasket
2270-0136	Cap Filler Disk
CAP-EXT-BAG10	Spacer Cap (Bag of 10)

HARDI® AND JACTO® ADAPTERS

Part Number	Adapters For	Description
9950-0024	Hardi	10 pack of adapters for converting nozzle body to accept Hypro cap
9950-0027	Jacto	

Hardi is a registered trademark of Hardi International A/S. Jacto is a registered trademark of Jacto Inc. All other brand or product names are trademarks or registered trademarks of Pentair Ltd. Viton® is a registered trademark of DuPont. Hypro® is a registered trademark of Pentair.

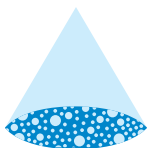

SPRAY NOZZLE CAP – TWINCAP



The Hypro® TwinCap is a simple, compact way of accommodating two spray nozzles back to back. This design allows you to apply the volume per acre you want, at the speed you want, without compromising spray quality.

- ◆ Improve control of plant diseases, insects, and difficult weeds
- ◆ Twin 30° angles improve canopy penetration
- ◆ Combined forward and backward angles enhance coverage on stems and leaves
- ◆ Holds any two standard dimension nozzles, including Hypro ULD, GA, LD, ADI, VP, TR, AXI, Flat, and Even nozzles
- ◆ User can select nozzles for the most effective spray
- ◆ Available in standard Polyacetal or in Gray PVDF for acid sprays

Part Numbers	
TwinCaps, less nozzles	
152607TC	Standard TwinCap for agrochemicals
15Q2530TC	Gray Acid-resistant Twin cap for defoliant
16Q2530TC	Hardi TwinCap
Replacement Parts	
10BG-2270-0150	Standard cap seal (A)
65MN011X1.3	Standard nozzle o-ring seal (B)
65VBS0113-13	Viton nozzle o-ring seal for Acid (B)
30Q3834	Replacement VPTCAP plug

NOZZLE STRAINERS



Ref #	Part Number	ISO Color	Mesh	Material	Description
1	TS01-50*	Blue	50	Polypropylene	Premium flow nozzle strainer
	TS01-100*	Green	100		Premium flow nozzle strainer for Guardian & GuardianAIR Twin
2	TS02-50*	Blue	50		Slotted nozzle strainer
	TS02-100*	Green	100		
3	TS03-25	Black	25	Nylon	
4	32100530	White	30	Stainless Steel	Nozzle filter with check
	32100550	Blue	50		Nozzle filter without check
	32100510	Green	100		
	32100050	Blue	50		
	32100010	Green	100		

*Order rounding QTY 10 (bags of 10)

GENERAL STRAINER RECOMMENDATIONS

Nozzle Flow Rate at 40 PSI (2.8 BAR)	Strainer Mesh	Example Fan Nozzle Size
Less than 0.10	200	005-0067
0.10-0.39	100	01-035
0.40-0.79	50	04-06
0.80-2.00	25	08-20

SPRAY DEMONSTRATION TABLES



- ◆ Plastic molded portable demonstration table with open see-through design.
- ◆ Clear 1" boom featuring three 5-way ProFlo nozzle bodies and Express End Caps and Express Tee.
- ◆ Lightweight design for easy transportation and storage.
- ◆ Powered by 115 VAC or 230 VAC Shurflo pump with filter.
- ◆ Standard Boom Addition - Clear 1" boom featuring three 5-way ProFlo nozzle bodies with standard boom ends.
- ◆ Use with Express End Cap boom (provided with table) & standard boom (3430-0017) for visual demonstration of Express End Cap benefits.

Part Number	Description
3040-0015	Standard spray table 115VAC, comes with express fittings boom and spray nozzle kit.
3040-0016	Standard Spray table 230VAC, comes with express fittings boom and spray nozzle kit.
3040-0017	Addition boom with dead end - to allow demonstration of that along with express end cap boom.
3040-0018	ProStop-E Boom Addition
3040-0019	DuoReact Boom Addition
3040-0020	Carrying Case
3040-0021	5059 pump upgrade with DC motor controller

SPRAY NOZZLE CALIBRATION TOOLS

Reference Number	Part Number	Description
1	9950-0022	32 oz. Calibration Jug
1	9950-0023	128 oz. Calibration Jug
2	9950-0031	Spray Nozzle Calibration pressure gauge
3	9950-0028	Water Sensitive paper (50 pack) 76x26mm (instructions included)
4	3000-0310	Nozzle Installation Tool



PRESSURE TRANSDUCER

Reference Number	Part Number	Description
2520-0239	2530-0207	1/4" NPT thread, 0 - 100 psi, 1% accuracy, bluetooth connectivity to SprayIT App enables real time droplet size monitoring.
2520-0240	4201N-B104	Single outlet nozzle body
2520-0241	CAP10-20	1/4" npt threaded spray cap

BROADCAST APPLICATION CHART-20" SPACING

Nozzle Size	Pressure (PSI)	Flow Rate (GPM)	Speed (MPH) - 20 inch nozzle spacing															
			Gallons per Acre															
			2.5	5	7.5	10	12.5	15	17.5	20	22.5	25	27.5	30	32.5	35	37.5	40
01	15	0.06	7.3	3.6	2.4	1.8	1.5	1.2	1.0	0.9	0.8	0.7	0.7	0.6	0.6	0.5	0.5	0.5
	20	0.07	8.4	4.2	2.8	2.1	1.7	1.4	1.2	1.1	0.9	0.8	0.8	0.7	0.6	0.6	0.6	0.6
	30	0.09	10.3	5.1	3.4	2.6	2.1	1.7	1.5	1.3	1.1	1.0	0.9	0.9	0.8	0.7	0.7	0.6
	40	0.10	11.9	5.9	4.0	3.0	2.4	2.0	1.7	1.5	1.3	1.2	1.1	1.0	0.9	0.8	0.8	0.8
	50	0.11	13.3	6.6	4.4	3.3	2.7	2.2	1.9	1.7	1.5	1.3	1.2	1.1	1.0	0.9	0.9	0.8
	60	0.12	14.5	7.3	4.8	3.6	2.9	2.4	2.1	1.8	1.6	1.5	1.3	1.2	1.1	1.0	1.0	0.9
	70	0.13	15.7	7.9	5.2	3.9	3.1	2.6	2.2	2.0	1.7	1.6	1.4	1.3	1.2	1.1	1.0	1.0
	80	0.14	16.8	8.4	5.6	4.2	3.4	2.8	2.4	2.1	1.9	1.7	1.5	1.4	1.3	1.2	1.1	1.1
	90	0.15	17.8	8.9	5.9	4.5	3.6	3.0	2.5	2.2	2.0	1.8	1.6	1.5	1.4	1.3	1.2	1.1
	100	0.16	18.8	9.4	6.3	4.7	3.8	3.1	2.7	2.3	2.1	1.9	1.7	1.6	1.4	1.3	1.2	1.1
	115	0.17	20.1	10.1	6.7	5.0	4.0	3.4	2.9	2.5	2.2	2.0	1.8	1.7	1.5	1.4	1.3	1.2
015	15	0.09	10.9	5.5	3.6	2.7	2.2	1.8	1.6	1.4	1.2	1.1	1.0	0.9	0.8	0.8	0.7	0.7
	20	0.11	12.6	6.3	4.2	3.2	2.5	2.1	1.8	1.6	1.4	1.3	1.1	1.1	1.0	0.9	0.8	0.8
	30	0.13	15.4	7.7	5.1	3.9	3.1	2.6	2.2	1.9	1.7	1.5	1.4	1.3	1.2	1.1	1.0	1.0
	40	0.15	17.8	8.9	5.9	4.5	3.6	3.0	2.5	2.2	2.0	1.8	1.6	1.5	1.4	1.3	1.2	1.1
	50	0.17	19.9	10.0	6.6	5.0	4.0	3.3	2.8	2.5	2.2	2.0	1.8	1.7	1.5	1.4	1.3	1.2
	60	0.18	21.8	10.9	7.3	5.5	4.4	3.6	3.1	2.7	2.4	2.2	2.0	1.8	1.7	1.6	1.5	1.4
	70	0.20	23.6	11.8	7.9	5.9	4.7	3.9	3.4	2.9	2.6	2.4	2.1	2.0	1.8	1.7	1.6	1.5
	80	0.21	25.2	12.6	8.4	6.3	5.0	4.2	3.6	3.2	2.8	2.5	2.3	2.1	1.9	1.8	1.7	1.6
	90	0.23	26.7	13.4	8.9	6.7	5.3	4.5	3.8	3.3	3.0	2.7	2.4	2.2	2.1	1.9	1.8	1.7
	100	0.24	28.2	14.1	9.4	7.0	5.6	4.7	4.0	3.5	3.1	2.8	2.6	2.3	2.2	2.0	1.9	1.8
	115	0.25	-	15.1	10.1	7.6	6.0	5.0	4.3	3.8	3.4	3.0	2.7	2.5	2.3	2.2	2.0	1.9
02	15	0.12	14.5	7.3	4.8	3.6	2.9	2.4	2.1	1.8	1.6	1.5	1.3	1.2	1.1	1.0	1.0	0.9
	20	0.14	16.9	8.4	5.6	4.2	3.4	2.8	2.4	2.1	1.9	1.7	1.5	1.4	1.3	1.2	1.1	1.1
	30	0.17	20.6	9.9	5.1	4.1	3.4	2.9	2.4	2.1	1.9	1.7	1.6	1.5	1.4	1.3	1.2	1.1
	40	0.20	23.8	11.9	7.9	5.9	4.8	4.0	3.4	3.0	2.6	2.4	2.2	2.0	1.8	1.7	1.6	1.5
	50	0.22	26.6	13.3	8.9	6.6	5.3	4.4	3.8	3.3	3.0	2.7	2.4	2.2	2.0	1.9	1.8	1.7
	60	0.24	29.1	14.5	9.7	7.3	5.8	4.8	4.2	3.6	3.2	2.9	2.6	2.4	2.2	2.1	1.9	1.8
	70	0.26	-	15.7	10.5	7.9	6.3	5.2	4.5	3.9	3.5	3.1	2.9	2.6	2.4	2.2	2.1	2.0
	80	0.28	-	16.8	11.2	8.4	6.7	5.6	4.8	4.2	3.7	3.4	3.1	2.8	2.6	2.4	2.2	2.1
	90	0.30	-	17.8	11.9	8.9	7.1	5.9	5.1	4.5	4.0	3.6	3.2	3.0	2.7	2.5	2.4	2.2
	100	0.32	-	18.8	12.5	9.4	7.5	6.3	5.4	4.7	4.2	3.8	3.4	3.1	2.9	2.7	2.5	2.3
	115	0.34	-	20.1	13.4	10.1	8.1	6.7	5.8	5.0	4.5	4.0	3.7	3.4	3.1	2.9	2.7	2.5
025	15	0.15	18.2	9.1	6.1	4.5	3.6	3.0	2.6	2.3	2.0	1.8	1.7	1.5	1.4	1.3	1.2	1.1
	20	0.18	21.0	10.5	7.0	5.3	4.2	3.5	3.0	2.6	2.3	2.1	1.9	1.8	1.6	1.5	1.4	1.3
	30	0.22	25.7	12.9	8.6	6.4	5.1	4.3	3.7	3.2	2.9	2.6	2.3	2.1	2.0	1.8	1.7	1.6
	40	0.25	29.7	14.9	9.9	7.4	5.9	5.0	4.2	3.7	3.3	3.0	2.7	2.5	2.3	2.1	2.0	1.9
	50	0.28	-	16.6	11.1	8.3	6.6	5.5	4.7	4.2	3.7	3.3	3.0	2.8	2.6	2.4	2.2	2.1
	60	0.31	-	18.2	12.1	9.1	7.3	6.2	5.2	4.5	4.0	3.6	3.3	3.0	2.8	2.6	2.4	2.2
	70	0.33	-	19.6	13.1	9.8	7.9	6.5	5.6	4.9	4.4	3.9	3.6	3.3	3.0	2.8	2.6	2.5
	80	0.35	-	21.0	14.0	10.5	8.4	7.0	6.0	5.3	4.7	4.2	3.8	3.5	3.2	3.0	2.8	2.6
	90	0.38	-	22.3	14.9	11.1	8.9	7.4	6.4	5.6	5.0	4.5	4.1	3.7	3.4	3.2	3.0	2.8
	100	0.40	-	23.5	15.7	11.7	9.4	7.8	6.7	5.9	5.2	4.7	4.3	3.9	3.6	3.4	3.1	2.9
	115	0.42	-	25.2	16.8	12.6	10.1	8.4	7.2	6.3	5.6	5.0	4.6	4.2	3.9	3.6	3.4	3.1
03	15	0.18	21.8	10.9	7.3	5.5	4.4	3.6	3.1	2.7	2.4	2.2	2.0	1.8	1.7	1.6	1.5	1.4
	20	0.21	25.2	12.6	8.4	6.3	5.0	4.2	3.6	3.2	2.8	2.5	2.3	2.1	1.9	1.8	1.7	1.6
	30	0.26	-	15.4	10.3	7.7	6.2	5.1	4.4	3.9	3.4	3.1	2.8	2.6	2.4	2.2	2.1	1.9
	40	0.30	-	17.8	11.9	8.9	7.1	5.9	5.1	4.5	4.0	3.6	3.2	3.0	2.7	2.5	2.4	2.2
	50	0.34	-	19.9	13.3	10.0	8.0	6.6	5.7	5.0	4.4	4.0	3.6	3.3	3.1	2.8	2.7	2.5
	60	0.37	-	21.8	14.5	10.9	8.7	7.3	6.2	5.5	4.8	4.4	4.0	3.6	3.4	3.1	2.9	2.7
	70	0.40	-	23.6	15.7	11.8	9.4	7.9	6.7	5.9	5.2	4.7	4.3	3.9	3.6	3.4	3.1	2.9
	80	0.42	-	25.2	16.8	12.6	10.1	8.4	7.2	6.3	5.6	5.0	4.6	4.2	3.9	3.6	3.4	3.2
	90	0.45	-	26.7	17.8	13.4	10.7	8.9	7.6	6.7	5.9	5.3	4.9	4.5	4.1	3.8	3.6	3.3
	100	0.47	-	28.2	18.8	14.1	11.3	9.4	8.1	7.0	6.3	5.6	5.1	4.7	4.3	4.0	3.8	3.5
	115	0.51	-	30.1	20.1	15.1	12.1	10.1	8.6	7.6	6.7	6.0	5.5	5.0	4.6	4.3	4.0	3.8
04	15	0.24	29.1	14.5	9.7	7.3	5.8	4.8	4.2	3.6	3.2	2.9	2.6	2.4	2.2	2.1	1.9	1.8
	20	0.28	-	16.8	11.2	8.4	6.7	5.6	4.8	4.2	3.7	3.4	3.1	2.8	2.6	2.4	2.2	2.1
	30	0.35	-	20.6	13.7	10.3	8.2	6.9	5.9	5.1	4.6	4.1	3.7	3.4	3.2	2.9	2.7	2.6
	40	0.40	-	23.8	15.8	11.9	9.5	7.9	6.8	5.9	5.3	4.8	4.3	4.0	3.7	3.4	3.2	3.0
	50	0.45	-	26.6	17.7	13.3	10.6	8.9	7.6	6.6	5.9	5.3	4.8	4.4	4.1	3.8	3.5	3.3
	60	0.49	-	29.1	19.4	14.5	11.6	9.7	8.3	7.3	6.5	5.8	5.3	4.8	4.5	4.2	3.9	3.6
	70	0.53	-	-	21.0	15.7	12.6	10.5	9.0	7.9	7.0	6.3	5.7	5.2	4.8	4.5	4.2	3.9
	80	0.57	-	-	22.4	16.8	13.4	11.2	9.6	8.4	7.5	6.7	6.1	5.6	5.2	4.8	4.5	4.2
	90	0.60	-	-	23.8	17.8	14.3	11.9	10.2	8.9	7.9	7.1	6.5	5.9	5.5	5.1	4.8	4.5
	100	0.63	-	-	25.0	18.8	15.0	12.5	10.7	9.4	8.3	7.5	6.8	6.3	5.8	5.4	5.0	4.7
	115	0.68	-	-	26.9	20.1	16.1	13.4	11.5	10.1	9.0	8.1	7.3	6.7	6.2	5.8	5.4	5.0
05	15	0.31	-	16.2	12.1	9.1	7.3	6.1	5.2	4.5	4.0	3.6	3.3	3.0	2.8	2.6	2.4	2.3
	20	0.35	-	21.0	14.0	10.5	8.4	7.0	6.0	5.3	4.7	4.2	3.8	3.5	3.2	3.0	2.8	2.6
	30	0.43	-	25.7	17.1	12.9	10.3	8.6	7.3	6.4	5.7	5.1	4.7					

HI-FLOW APPLICATION CHART - 20", 40" & 60" SPACING

Nozzle Size	Pressure (PSI)	Flow Rate (GPM)	Speed (MPH) - 20 inch nozzle spacing							Speed (MPH) - 40 inch nozzle spacing							Speed (MPH) - 60 inch nozzle spacing						
			Gallons per Acre							Gallons per Acre							Gallons per Acre						
			15	30	45	60	75	90	105	15	30	45	60	75	90	105	15	30	45	60	75	90	105
08	20	0.57	11	6	4	3	2	2	2	6	3	2	1	1	1	1	4	2	1	1	1	1	1
	30	0.69	14	7	5	3	3	2	2	7	3	2	2	1	1	1	5	2	2	1	1	1	1
	40	0.80	16	8	5	4	3	3	2	8	4	3	2	2	1	1	5	3	2	1	1	1	1
	50	0.89	18	9	6	4	4	3	3	9	4	3	2	2	1	1	6	3	2	1	1	1	1
	60	0.98	19	10	6	5	4	3	3	10	5	3	2	2	2	1	6	3	2	2	1	1	1
	70	1.06	21	10	7	5	4	3	3	10	5	3	3	2	2	1	7	3	2	2	1	1	1
	80	1.13	22	11	7	6	4	4	3	11	6	4	3	2	2	2	7	4	2	2	1	1	1
10	20	0.71	14	7	5	4	3	2	2	7	4	2	2	1	1	1	5	2	2	1	1	1	1
	30	0.87	17	9	6	4	3	3	2	9	4	3	2	2	1	1	6	3	2	1	1	1	1
	40	1.00	20	10	7	5	4	3	3	10	5	3	2	2	2	1	7	3	2	2	1	1	1
	50	1.12	22	11	7	6	4	4	3	11	6	4	3	2	2	2	7	4	2	2	1	1	1
	60	1.22	24	12	8	6	5	4	3	12	6	4	3	2	2	2	8	4	3	2	2	1	1
	70	1.32	26	13	9	7	5	4	4	13	7	4	3	3	2	2	9	4	3	2	2	1	1
	80	1.41	28	14	9	7	6	5	4	14	7	5	3	3	2	2	9	5	3	2	2	2	1
15	20	1.06	21	10	7	5	4	3	3	10	5	3	3	2	2	1	7	3	2	2	1	1	1
	30	1.30	26	13	9	6	5	4	4	13	6	4	3	3	2	2	9	4	3	2	2	1	1
	40	1.50	30	15	10	7	6	5	4	15	7	5	4	3	2	2	10	5	3	2	2	2	1
	50	1.68	33	17	11	8	7	6	5	17	8	6	4	3	3	2	11	6	4	3	2	2	2
	60	1.84	36	18	12	9	7	6	5	18	9	6	5	4	3	3	12	6	4	3	2	2	2
	70	2.0	40	20	13	10	8	7	6	20	10	7	5	4	3	3	13	7	4	3	3	2	2
	80	2.1	42	21	14	10	8	7	6	21	10	7	5	4	3	3	14	7	5	3	3	2	2
20	20	1.41	28	14	9	7	6	5	4	14	7	5	3	3	2	2	9	5	3	2	2	2	1
	30	1.73	34	17	11	9	7	6	5	17	9	6	4	3	3	2	11	6	4	3	2	2	2
	40	2.0	40	20	13	10	8	7	6	20	10	7	5	4	3	3	13	7	4	3	3	2	2
	50	2.2	44	22	15	11	9	7	6	22	11	7	5	4	4	3	15	7	5	4	3	2	2
	60	2.4	48	24	16	12	10	8	7	24	12	8	6	5	4	3	16	8	5	4	3	3	2
	70	2.6	51	26	17	13	10	9	7	26	13	9	6	5	4	4	17	9	6	4	3	3	2
	80	2.8	55	28	18	14	11	9	8	28	14	9	7	6	5	4	18	9	6	5	4	3	3
30	20	2.1	42	21	14	10	8	7	6	21	10	7	5	4	3	3	14	7	5	3	3	2	2
	30	2.6	51	26	17	13	10	9	7	26	13	9	6	5	4	4	17	9	6	4	3	3	2
	40	3.0	59	30	20	15	12	10	8	30	15	10	7	6	5	4	20	10	7	5	4	3	3
	50	3.4	67	34	22	17	13	11	10	34	17	11	8	7	6	5	22	11	7	6	4	4	3
	60	3.7	73	37	24	18	15	12	10	37	18	12	9	7	6	5	24	12	8	6	5	4	3
	70	4.0	79	40	26	20	16	13	11	40	20	13	10	8	7	6	26	13	9	7	5	4	4
	80	4.2	83	42	28	21	17	14	12	42	21	14	10	8	7	6	28	14	9	7	6	5	4
40	20	2.8	55	28	18	14	11	9	8	28	14	9	7	6	5	4	18	9	6	5	4	3	3
	30	3.5	69	35	23	17	14	12	10	35	17	12	9	7	6	5	23	12	8	6	5	4	3
	40	4.0	79	40	26	20	16	13	11	40	20	13	10	8	7	6	26	13	9	7	5	4	4
	50	4.5	89	45	30	22	18	15	13	45	22	15	11	9	7	6	30	15	10	7	6	5	4
	60	4.9	97	49	32	24	19	16	14	49	24	16	12	10	8	7	32	16	11	8	6	5	5
	70	5.3	105	52	35	26	21	17	15	52	26	17	13	10	9	7	35	17	12	9	7	6	5
	80	5.7	113	56	38	28	23	19	16	56	28	19	14	11	9	8	38	19	13	9	8	6	5
50	20	3.5	69	35	23	17	14	12	10	35	17	12	9	7	6	5	23	12	8	6	5	4	3
	30	4.3	85	43	28	21	17	14	12	43	21	14	11	9	7	6	28	14	9	7	6	5	4
	40	5.0	99	50	33	25	20	17	14	50	25	17	12	10	8	7	33	17	11	8	7	6	5
	50	5.6	111	55	37	28	22	18	16	55	28	18	14	11	9	8	37	18	12	9	7	6	5
	60	6.1	121	60	40	30	24	20	17	60	30	20	15	12	10	9	40	20	13	10	8	7	6
	70	6.6	131	65	44	33	26	22	19	65	33	22	16	13	11	9	44	22	15	11	9	7	6
	80	7.1	141	70	47	35	28	23	20	70	35	23	18	14	12	10	47	23	16	12	9	8	7
60	20	4.2	83	42	28	21	17	14	12	42	21	14	10	8	7	6	28	14	9	7	6	5	4
	30	5.2	103	51	34	26	21	17	15	51	26	17	13	10	9	7	34	17	11	9	7	6	5
	40	6.0	119	59	40	30	24	20	17	59	30	20	15	12	10	8	40	20	13	10	8	7	6
	50	6.7	133	66	44	33	27	22	19	66	33	22	17	13	11	9	44	22	15	11	9	7	6
	60	7.3	145	72	48	36	29	24	21	72	36	24	18	14	12	10	48	24	16	12	10	8	7
	70	7.9	156	78	52	39	31	26	22	78	39	26	20	16	13	11	52	26	17	13	10	9	7
	80	8.5	168	84	56	42	34	28	24	84	42	28	21	17	14	12	56	28	19	14	11	9	8

BROADCAST APPLICATION CHART-15" SPACING

Nozzle Size	Pressure (PSI)	Flow Rate (GPM)	Speed (MPH) - 15 inch nozzle spacing															
			Gallons per Acre															
			2.5	5	7.5	10	12.5	15	17.5	20	22.5	25	27.5	30	32.5	35	37.5	40
01	15	0.06	9.7	4.8	3.2	2.4	1.9	1.6	1.4	1.2	1.1	1.0	0.9	0.8	0.7	0.7	0.6	0.6
	20	0.07	11.2	5.6	3.7	2.8	2.2	1.9	1.6	1.4	1.2	1.1	1.0	0.9	0.9	0.8	0.7	0.7
	30	0.09	13.7	6.9	4.6	3.4	2.7	2.3	2.0	1.7	1.5	1.4	1.2	1.1	1.1	1.0	0.9	0.9
	40	0.10	15.8	7.9	5.3	4.0	3.2	2.6	2.3	2.0	1.8	1.6	1.4	1.3	1.2	1.1	1.1	1.0
	50	0.11	17.7	8.9	5.9	4.4	3.5	3.0	2.5	2.2	2.0	1.8	1.6	1.5	1.4	1.3	1.2	1.1
	60	0.12	19.4	9.7	6.5	4.8	3.9	3.2	2.8	2.4	2.2	1.9	1.8	1.6	1.5	1.4	1.3	1.2
	70	0.13	21.0	10.5	7.0	5.2	4.2	3.5	3.0	2.6	2.3	2.1	1.9	1.7	1.6	1.5	1.4	1.3
	80	0.14	22.4	11.2	7.5	5.6	4.5	3.7	3.2	2.8	2.5	2.2	2.0	1.9	1.7	1.6	1.5	1.4
	90	0.15	23.8	11.9	7.9	5.9	4.8	4.0	3.4	3.0	2.6	2.4	2.2	2.0	1.8	1.7	1.6	1.5
	100	0.16	25.0	12.5	8.3	6.3	5.0	4.2	3.6	3.1	2.8	2.5	2.3	2.1	1.9	1.8	1.7	1.6
	115	0.17	26.9	13.4	9.0	6.7	5.4	4.5	3.8	3.4	3.0	2.7	2.4	2.2	2.1	1.9	1.8	1.7
015	15	0.09	14.5	7.3	4.8	3.6	2.9	2.4	2.1	1.8	1.6	1.5	1.3	1.2	1.1	1.0	1.0	0.9
	20	0.11	16.8	8.4	5.6	4.2	3.4	2.8	2.4	2.1	1.9	1.7	1.5	1.4	1.3	1.2	1.1	1.1
	30	0.13	20.6	10.3	6.9	5.1	4.1	3.4	2.9	2.6	2.3	2.1	1.9	1.7	1.6	1.5	1.4	1.3
	40	0.15	23.8	11.9	7.9	5.9	4.8	4.0	3.4	3.0	2.6	2.4	2.2	2.0	1.8	1.7	1.6	1.5
	50	0.17	26.6	13.3	8.9	6.6	5.3	4.4	3.8	3.3	3.0	2.7	2.4	2.2	2.0	1.9	1.8	1.7
	60	0.18	29.1	14.5	9.7	7.3	5.8	4.8	4.2	3.6	3.2	2.9	2.6	2.4	2.2	2.1	1.9	1.8
	70	0.20	-	15.7	10.5	7.9	6.3	5.2	4.5	3.9	3.5	3.1	2.9	2.6	2.4	2.2	2.1	2.0
	80	0.21	-	16.8	11.2	8.4	6.7	5.6	4.8	4.2	3.7	3.4	3.1	2.8	2.6	2.4	2.2	2.1
	90	0.23	-	17.8	11.9	8.9	7.1	5.9	5.1	4.5	4.0	3.6	3.2	3.0	2.7	2.5	2.4	2.2
	100	0.24	-	18.8	12.5	9.4	7.5	6.3	5.4	4.7	4.2	3.8	3.4	3.1	2.9	2.7	2.5	2.3
	115	0.25	-	20.1	13.4	10.1	8.1	6.7	5.8	5.0	4.5	4.0	3.7	3.4	3.1	2.9	2.7	2.5
02	15	0.12	19.4	9.7	6.5	4.8	3.9	3.2	2.8	2.4	2.2	1.9	1.8	1.6	1.5	1.4	1.3	1.2
	20	0.14	22.4	11.2	7.5	5.6	4.5	3.7	3.2	2.8	2.5	2.2	2.0	1.9	1.7	1.6	1.5	1.4
	30	0.17	27.4	13.7	9.1	6.9	5.5	4.6	3.9	3.4	3.0	2.7	2.5	2.3	2.1	2.0	1.8	1.7
	40	0.20	-	15.8	10.6	7.9	6.3	5.3	4.5	4.0	3.5	3.2	2.9	2.6	2.4	2.3	2.1	2.0
	50	0.22	-	17.7	11.8	8.9	7.1	5.9	5.1	4.4	3.9	3.5	3.2	3.0	2.7	2.5	2.4	2.2
	60	0.24	-	19.4	12.9	9.7	7.8	6.5	5.5	4.8	4.3	3.9	3.5	3.2	3.0	2.8	2.6	2.4
	70	0.26	-	21.0	14.0	10.5	8.4	7.0	6.0	5.2	4.7	4.2	3.8	3.5	3.2	3.0	2.8	2.6
	80	0.28	-	22.4	14.9	11.2	9.0	7.5	6.4	5.6	5.0	4.5	4.1	3.7	3.4	3.2	3.0	2.8
	90	0.30	-	23.8	15.8	11.9	9.5	7.9	6.8	5.9	5.3	4.8	4.3	4.0	3.7	3.4	3.2	3.0
	100	0.32	-	25.0	16.7	12.5	10.1	8.3	7.2	6.3	5.6	5.0	4.6	4.2	3.9	3.6	3.3	3.1
	115	0.34	-	26.9	17.9	13.4	10.7	9.0	7.7	6.7	6.0	5.4	4.9	4.5	4.1	3.8	3.5	3.3
025	15	0.15	24.2	12.1	8.1	6.1	4.8	4.0	3.5	3.0	2.7	2.4	2.2	2.0	1.9	1.7	1.6	1.5
	20	0.18	28.0	14.0	9.3	7.0	5.6	4.7	4.0	3.5	3.1	2.8	2.5	2.3	2.2	2.0	1.9	1.8
	30	0.22	-	17.1	11.4	8.6	6.9	5.7	4.9	4.3	3.8	3.4	3.1	2.9	2.6	2.4	2.3	2.1
	40	0.25	-	19.8	13.2	9.9	7.9	6.6	5.7	5.0	4.4	4.0	3.6	3.3	3.0	2.8	2.6	2.5
	50	0.28	-	22.1	14.8	11.1	8.9	7.4	6.3	5.5	4.9	4.4	4.0	3.7	3.4	3.2	3.0	2.8
	60	0.31	-	24.2	16.2	12.1	9.7	8.1	6.9	6.1	5.4	4.8	4.4	4.0	3.7	3.5	3.2	3.0
	70	0.33	-	26.2	17.5	13.1	10.5	8.7	7.5	6.5	5.8	5.2	4.8	4.4	4.0	3.7	3.5	3.3
	80	0.35	-	28.0	18.7	14.0	11.2	9.3	8.0	7.0	6.2	5.6	5.1	4.7	4.3	4.0	3.7	3.5
	90	0.38	-	29.7	19.8	14.9	11.9	9.9	8.5	7.4	6.6	5.9	5.4	5.0	4.6	4.2	4.0	3.7
	100	0.40	-	-	20.9	15.7	12.5	10.4	8.9	7.8	7.0	6.3	5.7	5.2	4.8	4.5	4.2	3.9
	115	0.42	-	-	22.4	16.8	13.4	11.2	9.6	8.4	7.6	6.7	6.1	5.6	5.2	4.8	4.5	4.2
03	15	0.18	29.1	14.5	9.7	7.3	5.9	4.9	4.2	3.5	3.2	2.9	2.6	2.4	2.2	2.1	1.9	1.8
	20	0.21	-	16.8	11.2	8.4	6.7	5.6	4.8	4.2	3.7	3.4	3.1	2.8	2.6	2.4	2.2	2.1
	30	0.26	-	20.6	13.7	10.3	8.2	6.9	5.9	5.1	4.6	4.1	3.7	3.4	3.2	2.9	2.7	2.6
	40	0.30	-	23.8	15.8	11.9	9.5	7.9	6.8	5.9	5.3	4.8	4.3	4.0	3.7	3.4	3.2	3.0
	50	0.34	-	26.6	17.7	13.3	10.6	8.9	7.6	6.6	5.9	5.3	4.8	4.4	4.1	3.8	3.5	3.3
	60	0.37	-	29.1	19.4	14.5	11.6	9.7	8.3	7.3	6.5	5.8	5.3	4.8	4.5	4.2	3.9	3.6
	70	0.40	-	-	21.0	15.7	12.6	10.5	9.0	7.9	7.0	6.3	5.7	5.2	4.8	4.5	4.2	3.9
	80	0.42	-	-	22.4	16.8	13.4	11.2	9.6	8.4	7.5	6.7	6.1	5.6	5.2	4.8	4.5	4.2
	90	0.45	-	-	23.8	17.8	14.3	11.9	10.2	8.9	7.9	7.1	6.5	5.9	5.5	5.1	4.8	4.5
	100	0.47	-	-	25.0	18.8	15.0	12.5	10.7	9.4	8.3	7.5	6.8	6.3	5.8	5.4	5.0	4.7
	115	0.51	-	-	26.9	20.1	16.1	13.4	11.5	10.1	9.0	8.1	7.3	6.7	6.2	5.8	5.4	5.0
04	15	0.24	-	19.4	12.9	9.7	7.8	6.5	5.5	4.8	4.3	3.9	3.5	3.2	3.0	2.8	2.6	2.4
	20	0.28	-	22.4	14.9	11.2	9.0	7.5	6.4	5.6	5.0	4.5	4.1	3.7	3.4	3.2	3.0	2.8
	30	0.35	-	27.4	18.3	13.7	11.0	9.1	7.8	6.9	6.1	5.5	5.0	4.6	4.2	3.9	3.7	3.4
	40	0.40	-	-	21.1	15.8	12.7	10.6	9.1	7.9	7.0	6.3	5.8	5.3	4.9	4.5	4.2	4.0
	50	0.45	-	-	23.6	17.7	14.2	11.9	10.1	8.9	7.9	7.1	6.4	5.9	5.4	5.1	4.7	4.4
	60	0.49	-	-	25.9	19.4	15.5	12.9	11.1	9.7	8.6	7.8	7.1	6.5	6.0	5.5	5.2	4.8
	70	0.53	-	-	27.9	21.0	16.8	14.0	12.0	10.5	9.3	8.4	7.6	7.0	6.4	6.0	5.6	5.2
	80	0.57	-	-	29.9	22.4	17.9	14.9	12.8	11.2	10.0	9.0	8.1	7.5	6.9	6.4	6.0	5.6
	90	0.60	-	-	-	23.8	19.0	15.8	13.6	11.9	10.6	9.5	8.6	7.9	7.3	6.8	6.3	5.9
	100	0.63	-	-	-	25.0	20.0	16.7	14.3	12.5	11.1	10.0	9.1	8.3	7.7	7.2	6.7	6.3
	115	0.68	-	-	-	26.9	21.5	17.9	15.3	13.4	11.9	10.7	9.8	9.0	8.3	7.7	7.2	6.7
05	15	0.31	-	24.2	16.2	12.1	9.7	8.1	6.9	6.1	5.4	4.8	4.4	4.0	3.7	3.5	3.2	3.0
	20	0.35	-	28.0	18.7	14.0	11.2	9.3	8.0	7.0	6.2	5.6	5.1	4.7	4.3	4.0	3.7	3.5
	30	0.43	-	-	22.9	17.1	13.7	11.4	9.8	8.6	7.6	6.9	6.2	5.7	5.3	4.9	4.6	4.3
	40	0.50	-	-	26.4	19.8	15.8	13.2	11.3	9.9	8.8	7.9	7.2	6.6	6.1	5.7	5.3	5.0
	50	0.56	-	-	29.5	22.1	17.7	14.8	12.6	11.1	9.8	8.9						

HI-FLOW APPLICATION CHART - 15", 30" & 45" SPACING

Nozzle Size	Pressure (PSI)	Flow Rate (GPM)	Speed (MPH) - 15 inch nozzle spacing								Speed (MPH) - 30 inch nozzle spacing								Speed (MPH) - 45 inch nozzle spacing							
			Gallons per Acre								Gallons per Acre								Gallons per Acre							
			5	6	8	10	12	14	16		5	6	8	10	12	14	16		5	6	8	10	12	14	16	
08	20	0.57	-	-	28	23	18.8	16.1	14.1	23	18.8	14.1	11.3	9.4	8.1	7.1	15.0	12.5	9.4	7.5	6.3	5.4	4.7			
	30	0.69	-	-	-	27	23	19.5	17.1	27	23	17.1	13.7	11.4	9.8	8.5	18.2	15.2	11.4	9.1	7.6	6.5	5.7			
	40	0.80	-	-	-	-	26	23	19.8	-	26	19.8	15.8	13.2	11.3	9.9	21	17.6	13.2	10.6	8.8	7.5	6.6			
	50	0.89	-	-	-	-	29	25	22	-	29	22	17.6	14.7	12.6	11.0	23	19.6	14.7	11.7	9.8	8.4	7.3			
	60	0.98	-	-	-	-	-	28	24	-	-	24	19.4	16.2	13.9	12.1	26	22	16.2	12.9	10.8	9.2	8.1			
	70	1.06	-	-	-	-	-	30	26	-	-	26	21	17.5	15.0	13.1	28	23	17.5	14.0	11.7	10.0	8.7			
	80	1.13	-	-	-	-	-	-	28	-	-	28	22	18.6	16.0	14.0	30	25	18.6	14.9	12.4	10.7	9.3			
10	20	0.71	-	-	-	28	23	20	17.6	28	23	17.6	14.1	11.7	10.0	8.8	18.7	15.6	11.7	9.4	7.8	6.7	5.9			
	30	0.87	-	-	-	-	29	25	22	-	29	22	17.2	14.4	12.3	10.8	23	19.1	14.4	11.5	9.6	8.2	7.2			
	40	1.00	-	-	-	-	-	28	25	-	-	25	19.8	16.5	14.1	12.4	26	22	16.5	13.2	11.0	9.4	8.3			
	50	1.12	-	-	-	-	-	-	28	-	-	28	22	18.5	15.8	13.9	30	25	18.5	14.8	12.3	10.6	9.2			
	60	1.22	-	-	-	-	-	-	30	-	-	-	24	20	17.3	15.1	-	27	20	16.1	13.4	11.5	10.1			
	70	1.32	-	-	-	-	-	-	-	-	-	-	26	22	18.7	16.3	-	29	22	17.4	14.5	12.4	10.9			
	80	1.41	-	-	-	-	-	-	-	-	-	-	28	23	19.9	17.4	-	-	23	18.6	15.5	13.3	11.6			
15	20	1.06	-	-	-	-	-	30	26	-	35	26	21	17.5	15.0	13.1	28	23	17.5	14.0	11.7	10.0	8.7			
	30	1.30	-	-	-	-	-	-	-	-	-	-	26	21	18.4	16.1	-	29	21	17.2	14.3	12.3	10.7			
	40	1.50	-	-	-	-	-	-	-	-	-	-	30	25	21	18.6	-	-	25	19.8	16.5	14.1	12.4			
	50	1.68	-	-	-	-	-	-	-	-	-	-	-	28	24	21	-	-	28	22	18.5	15.8	13.9			
	60	1.84	-	-	-	-	-	-	-	-	-	-	-	30	26	23	-	-	-	24	20	17.3	15.2			
	70	2.0	-	-	-	-	-	-	-	-	-	-	-	33	28	25	-	-	-	26	22	18.9	16.5			
	80	2.1	-	-	-	-	-	-	-	-	-	-	-	30	26	-	-	-	28	23	19.8	17.3				
20	20	1.41	-	-	-	-	-	-	-	-	46	35	28	23	19.8	17.3	-	-	23	18.5	15.4	13.2	11.6			
	30	1.73	-	-	-	-	-	-	-	-	-	-	-	28	24	21	-	-	28	22	18.7	16.0	14.0			
	40	2.0	-	-	-	-	-	-	-	-	-	-	-	-	28	25	-	-	-	26	22	18.9	16.5			
	50	2.2	-	-	-	-	-	-	-	-	-	-	-	-	-	27	-	-	-	29	24	21	18.2			
	60	2.4	-	-	-	-	-	-	-	-	-	-	-	-	-	30	-	-	-	-	26	23	19.8			
	70	2.6	-	-	-	-	-	-	-	-	-	-	-	-	-	32	-	-	-	-	29	25	21			
	80	2.8	-	-	-	-	-	-	-	-	-	-	-	-	-	-	-	-	-	-	-	26	23			
30	20	2.1	-	-	-	-	-	-	-	-	-	-	-	-	30	26	-	46	35	28	23	19.8	17.3			
	30	2.6	-	-	-	-	-	-	-	-	-	-	-	-	-	-	-	-	-	-	29	25	21			
	40	3.0	-	-	-	-	-	-	-	-	-	-	-	-	-	-	-	-	-	-	-	28	25			
	50	3.4	-	-	-	-	-	-	-	-	-	-	-	-	-	-	-	-	-	-	-	-	28			
	60	3.7	-	-	-	-	-	-	-	-	-	-	-	-	-	-	-	-	-	-	-	-	-			
	70	4.0	-	-	-	-	-	-	-	-	-	-	-	-	-	-	-	-	-	-	-	-	-			
	80	4.2	-	-	-	-	-	-	-	-	-	-	-	-	-	-	-	-	-	-	-	-	-			
40	20	2.8	-	-	-	-	-	-	-	-	-	-	-	-	-	-	-	-	-	-	-	26	23			
	30	3.5	-	-	-	-	-	-	-	-	-	-	-	-	-	-	-	-	-	-	-	-	29			
	40	4.0	-	-	-	-	-	-	-	-	-	-	-	-	-	-	-	-	-	-	-	-	-			
	50	4.5	-	-	-	-	-	-	-	-	-	-	-	-	-	-	-	-	-	-	-	-	-			
	60	4.9	-	-	-	-	-	-	-	-	-	-	-	-	-	-	-	-	-	-	-	-	-			
	70	5.3	-	-	-	-	-	-	-	-	-	-	-	-	-	-	-	-	-	-	-	-	-			
	80	5.7	-	-	-	-	-	-	-	-	-	-	-	-	-	-	-	-	-	-	-	-	-			
50	20	3.5	-	-	-	-	-	-	-	-	-	-	-	-	-	-	-	-	-	-	-	-	29			
	30	4.3	-	-	-	-	-	-	-	-	-	-	-	-	-	-	-	-	-	-	-	-	-			
	40	5.0	-	-	-	-	-	-	-	-	-	-	-	-	-	-	-	-	-	-	-	-	-			
	50	5.6	-	-	-	-	-	-	-	-	-	-	-	-	-	-	-	-	-	-	-	-	-			
	60	6.1	-	-	-	-	-	-	-	-	-	-	-	-	-	-	-	-	-	-	-	-	-			
	70	6.6	-	-	-	-	-	-	-	-	-	-	-	-	-	-	-	-	-	-	-	-	-			
	80	7.1	-	-	-	-	-	-	-	-	-	-	-	-	-	-	-	-	-	-	-	-	-			
60	20	4.2	-	-	-	-	-	-	-	-	-	-	-	-	-	-	-	-	-	-	-	-	-			
	30	5.2	-	-	-	-	-	-	-	-	-	-	-	-	-	-	-	-	-	-	-	-	-			
	40	6.0	-	-	-	-	-	-	-	-	-	-	-	-	-	-	-	-	-	-	-	-	-			
	50	6.7	-	-	-	-	-	-	-	-	-	-	-	-	-	-	-	-	-	-	-	-	-			
	60	7.3	-	-	-	-	-	-	-	-	-	-	-	-	-	-	-	-	-	-	-	-	-			
	70	7.9	-	-	-	-	-	-	-	-	-	-	-	-	-	-	-	-	-	-	-	-	-			
	80	8.5	-	-	-	-	-	-	-	-	-	-	-	-	-	-	-	-	-	-	-	-	-			

BROADCAST APPLICATION CHART - 50 CM SPACING

Nozzle Size	Pressure (BAR)	Flow Rate (GPM)	K/M/H																		
			Liters per Hectacre																		
			40	60	80	100	120	140	160	180	200	220	240	260	280	300	320	340	360	380	400
01	0.7	0.19	5.8	3.9	2.9	2.3	1.9	1.7	1.4	1.3	1.2	1.1	1.0	0.9	0.8	0.8	0.7	0.7	0.6	0.6	0.6
	1	0.23	6.9	4.6	3.5	2.8	2.3	2.0	1.7	1.5	1.4	1.3	1.2	1.1	1.0	0.9	0.9	0.8	0.8	0.7	0.7
	1.5	0.28	8.5	5.7	4.2	3.4	2.8	2.4	2.1	1.9	1.7	1.5	1.4	1.3	1.2	1.1	1.0	0.9	0.9	0.8	0.8
	2	0.33	9.8	6.5	4.9	3.9	3.3	2.8	2.4	2.2	2.0	1.8	1.6	1.5	1.4	1.3	1.2	1.1	1.0	1.0	0.9
	2.5	0.37	11.0	7.3	5.5	4.4	3.7	3.1	2.7	2.4	2.2	2.0	1.8	1.7	1.6	1.5	1.4	1.3	1.2	1.1	1.0
	3	0.40	12.0	8.0	6.0	4.8	4.0	3.4	3.0	2.7	2.4	2.2	2.0	1.8	1.7	1.6	1.5	1.4	1.3	1.2	1.1
	4	0.46	13.9	9.2	6.9	5.5	4.6	4.0	3.5	3.1	2.8	2.5	2.3	2.1	2.0	1.8	1.7	1.6	1.5	1.4	1.4
	5	0.52	15.5	10.3	7.7	6.2	5.2	4.4	3.9	3.4	3.1	2.8	2.6	2.4	2.2	2.1	1.9	1.8	1.7	1.6	1.5
6	0.57	17.0	11.3	8.5	6.8	5.7	4.8	4.2	3.8	3.4	3.1	2.8	2.6	2.4	2.3	2.1	2.0	1.9	1.8	1.7	
7	0.61	18.3	12.2	9.2	7.3	6.1	5.2	4.6	4.1	3.7	3.3	3.1	2.8	2.6	2.4	2.3	2.2	2.0	1.9	1.8	
8	0.65	19.6	13.1	9.8	7.8	6.5	5.6	4.9	4.4	3.9	3.6	3.3	3.0	2.8	2.6	2.4	2.3	2.2	2.0	1.9	
015	0.7	0.29	8.7	5.8	4.3	3.5	2.9	2.5	2.2	1.9	1.7	1.6	1.4	1.3	1.2	1.1	1.0	1.0	0.9	0.9	
	1	0.35	10.4	6.9	5.2	4.2	3.5	3.0	2.6	2.3	2.1	1.9	1.7	1.6	1.5	1.4	1.3	1.2	1.1	1.0	
	1.5	0.42	12.7	8.5	6.4	5.1	4.2	3.6	3.2	2.8	2.5	2.3	2.1	2.0	1.8	1.7	1.6	1.5	1.4	1.3	
	2	0.49	14.7	9.8	7.3	5.9	4.9	4.2	3.7	3.3	2.9	2.7	2.4	2.3	2.1	2.0	1.8	1.7	1.6	1.5	
	2.5	0.55	16.4	11.0	8.2	6.6	5.5	4.7	4.1	3.7	3.3	3.0	2.7	2.5	2.3	2.2	2.1	1.9	1.8	1.7	
	3	0.60	18.0	12.0	9.0	7.2	6.0	5.1	4.5	4.0	3.6	3.3	3.0	2.8	2.6	2.4	2.3	2.1	2.0	1.9	
	4	0.69	20.8	13.9	10.4	8.3	6.9	5.9	5.2	4.6	4.2	3.8	3.5	3.2	3.0	2.8	2.6	2.4	2.3	2.2	
	5	0.77	23.2	15.5	11.6	9.3	7.7	6.6	5.8	5.2	4.6	4.2	3.9	3.6	3.3	3.1	2.9	2.7	2.6	2.4	
6	0.85	25.5	17.0	12.7	10.2	8.5	7.3	6.4	5.7	5.0	4.5	4.2	3.9	3.6	3.4	3.2	3.0	2.9	2.7		
7	0.92	27.5	18.3	13.7	11.0	9.2	7.9	6.9	6.1	5.5	5.0	4.6	4.2	3.9	3.7	3.4	3.2	3.1	2.9		
8	0.98	29.4	19.6	14.7	11.8	9.8	8.4	7.3	6.5	5.9	5.3	4.9	4.5	4.2	3.9	3.7	3.5	3.3	3.1		
02	0.7	0.39	11.6	7.7	5.8	4.6	3.9	3.3	2.9	2.6	2.3	2.1	1.9	1.8	1.7	1.5	1.4	1.3	1.2	1.1	
	1	0.46	13.9	9.2	6.9	5.5	4.6	4.0	3.5	3.1	2.8	2.5	2.3	2.1	2.0	1.8	1.7	1.6	1.5	1.4	
	1.5	0.57	17.0	11.3	8.5	6.8	5.7	4.8	4.2	3.8	3.4	3.1	2.8	2.6	2.4	2.3	2.1	2.0	1.9	1.8	
	2	0.65	19.6	13.1	9.8	7.8	6.5	5.6	4.9	4.4	3.9	3.6	3.3	3.0	2.8	2.6	2.4	2.3	2.2	2.1	
	2.5	0.73	21.9	14.6	11.0	8.8	7.3	6.3	5.5	4.9	4.4	4.0	3.7	3.4	3.1	2.9	2.7	2.6	2.4	2.3	
	3	0.80	24.0	16.0	12.0	9.6	8.0	6.9	6.0	5.3	4.8	4.4	4.0	3.7	3.4	3.2	3.0	2.8	2.7	2.5	
	4	0.92	27.7	18.5	13.9	11.1	9.2	7.9	6.9	6.2	5.5	5.0	4.6	4.3	4.0	3.7	3.5	3.3	3.1	2.9	
	5	1.03	31.0	20.7	15.5	12.4	10.3	8.9	7.7	6.9	6.2	5.6	5.2	4.8	4.4	4.1	3.9	3.6	3.4	3.3	
6	1.13	33.9	22.6	17.0	13.6	11.3	9.7	8.5	7.5	6.8	6.2	5.7	5.2	4.8	4.5	4.2	4.0	3.8	3.6		
7	1.22	36.7	24.4	18.3	14.7	12.2	10.5	9.2	8.1	7.3	6.7	6.1	5.6	5.2	4.9	4.6	4.3	4.1	3.9		
8	1.31	39.2	26.1	19.6	15.7	13.1	11.2	9.8	8.7	7.8	7.1	6.5	6.0	5.6	5.2	4.9	4.6	4.4	4.1		
025	0.7	0.58	17.4	11.6	8.7	7.0	5.8	5.0	4.3	3.9	3.5	3.2	2.9	2.7	2.5	2.3	2.2	2.0	1.9	1.8	
	1	0.69	20.8	13.9	10.4	8.3	6.9	5.9	5.2	4.6	4.2	3.8	3.5	3.2	3.0	2.8	2.6	2.4	2.3	2.2	
	1.5	0.85	25.5	17.0	12.7	10.2	8.5	7.3	6.4	5.7	5.1	4.6	4.2	3.9	3.6	3.4	3.2	3.0	2.8	2.7	
	2	0.98	29.4	19.6	14.7	11.8	9.8	8.4	7.3	6.5	5.9	5.3	4.9	4.5	4.2	3.9	3.7	3.5	3.3	3.1	
	2.5	1.10	32.9	21.9	16.4	13.1	11.0	9.4	8.2	7.3	6.6	6.0	5.5	5.1	4.7	4.4	4.1	3.9	3.7	3.5	
	3	1.20	36.0	24.0	18.0	14.4	12.0	10.3	9.0	8.0	7.2	6.5	6.0	5.5	5.1	4.8	4.5	4.2	4.0	3.8	
	4	1.39	41.6	27.7	20.8	16.6	13.9	11.9	10.4	9.2	8.3	7.5	6.9	6.4	5.9	5.5	5.2	4.9	4.6	4.4	
	5	1.55	46.5	31.0	23.2	18.6	15.5	13.3	11.6	10.3	9.3	8.5	7.7	7.2	6.6	6.2	5.8	5.5	5.2	4.9	
6	1.70	50.9	33.9	25.5	20.4	17.0	14.5	12.7	11.3	10.2	9.3	8.5	7.8	7.3	6.8	6.4	6.0	5.7	5.4		
7	1.83	55.0	36.7	27.5	22.0	18.3	15.7	13.7	12.2	11.0	10.0	9.2	8.5	7.9	7.3	6.9	6.5	6.1	5.8		
8	1.96	58.8	39.2	29.4	23.5	19.6	16.8	14.7	13.1	11.8	10.7	9.8	9.0	8.4	7.8	7.3	6.9	6.5	6.2		
03	0.7	0.77	23.2	15.5	11.6	9.3	7.7	6.6	5.8	5.2	4.6	4.2	3.9	3.6	3.3	3.1	2.9	2.7	2.6	2.4	
	1	0.92	27.7	18.5	13.9	11.1	9.2	7.9	6.9	6.2	5.5	5.0	4.6	4.3	4.0	3.7	3.5	3.3	3.1	2.9	
	1.5	1.13	33.9	22.6	17.0	13.6	11.3	9.7	8.5	7.5	6.8	6.2	5.7	5.2	4.8	4.5	4.2	4.0	3.8	3.6	
	2	1.31	39.2	26.1	19.6	15.7	13.1	11.2	9.8	8.7	7.8	7.1	6.5	6.0	5.6	5.2	4.9	4.6	4.4	4.1	
	2.5	1.46	43.8	29.2	21.9	17.5	14.6	12.5	11.0	9.7	8.8	8.0	7.3	6.7	6.3	5.8	5.5	5.2	4.9	4.6	
	3	1.60	48.0	32.0	24.0	19.2	16.0	13.7	12.0	10.7	9.6	8.7	8.0	7.4	6.9	6.4	6.0	5.6	5.3	5.1	
	4	1.85	55.4	37.0	27.7	22.2	18.5	15.8	13.9	12.3	11.1	10.1	9.2	8.5	7.9	7.4	6.9	6.5	6.2	5.8	
	5	2.07	62.0	41.3	31.0	24.8	20.7	17.7	15.5	13.8	12.4	11.3	10.3	9.5	8.9	8.3	7.7	7.3	6.9	6.5	
6	2.26	67.9	45.3	33.9	27.2	22.6	19.4	17.0	15.1	13.6	12.3	11.3	10.4	9.7	9.1	8.5	8.0	7.5	7.1		
7	2.44	73.3	48.9	36.7	29.3	24.4	20.9	18.3	16.3	14.7	13.3	12.2	11.3	10.5	9.8	9.2	8.6	8.1	7.7		
8	2.61	78.4	52.3	39.2	32.4	26.1	22.4	19.6	17.5	15.7	14.3	13.1	12.2	11.2	10.5	9.8	9.2	8.7	8.2		
04	0.7	0.97	29.0	19.3	14.5	11.6	9.7	8.3	7.2	6.4	5.8	5.3	4.8	4.5	4.1	3.9	3.6	3.4	3.2	3.1	
	1	1.15	34.6	23.1	17.3	13.9	11.5	9.9	8.7	7.7	6.9	6.3	5.8	5.3	4.9	4.6	4.3	4.1	3.8	3.6	
	1.5	1.41	42.4	28.3	21.2	17.0	14.1	12.1	10.6	9.4	8.5	7.7	7.1	6.5	6.1	5.7	5.3	5.0	4.7	4.5	
	2	1.63	49.0	32.7	24.5	19.6	16.3	14.0	12.2	10.9	9.8	9.2	8.5	7.9	7.5	7.0	6.5	6.1	5.8	5.4	
	2.5	1.83	54.8	36.5	27.4	21.9	18.3	15.6	13.7	12.2	11.0	10.0	9.1	8.4	7.8	7.3	6.8	6.4	6.1	5.8	
	3	2.00	60.0	40.0	30.0	24.0	20.0	17.1	15.0	13.3	12.0	10.9	10.0	9.2	8.6	8.0	7.5	7.1	6.7	6.3	
	4	2.31	69.3	46.2	34.6	27.7	23.1	19.8	17.3	15.4	13.9	12.6	11.5	10.7	9.9	9.2	8.7	8.2	7.7	7.3	
	5	2.58	77.5	51.6	38.7	31.0	25.8	22.1	19.4	17.2	15.5	14.1	12.9	11.9	11.1	10.3	9.7	9.1	8.6	8.2	
6	2.83	84.9	56.6	42.4	33.9	28.3	24.2	21.2	18.9	17.0	15.4	14.1	13.1	12.1	11.3	10.6	10.0	9.4	8.9		
7	3.06	91.7	61.1	45.8	36.7	30.6	26.2	22.9	20.4	18.3	16.7	15.3	14.1	13.1	12.2	11.5	10.8	10.2	9.6		
8	3.27	98.0	65.3	49.0	39.2	32.7	28.0	24.5	21.8	19.6	17.8	16.3	15.1	14.0	13.1	12.2	11.5	10.9	10.3		
05	0.7	1.16	34.8	23.2	17.4	13.9	11.6	9.9	8.7	7.7	7.0	6.3	5.8	5.4	5.0	4.6	4.3	4.1	3.9	3.7	
	1	1.39	41.6	27.7	20.8	16.6	13.9	11.9	10.4	9.2	8.3	7.6	6.9	6.4	5.9	5.5	5.2	4.9	4.6	4.4	
	1.5	1.60	50.9	33.9	25.5	20.4	17.0	14.5	12.7	11.3	10.2	9.3	8.5	7.8							

HI-FLOW APPLICATION CHART - 50CM, 100CM & 150CM SPACING

Nozzle Size	BAR	LPM	Application Rate (L/ha) 50 cm spacing									Application Rate (L/ha) 100 cm spacing								Application Rate (L/ha) 150 cm spacing							
			KPH									KPH								KPH							
			7	8	10	12	15	20	25	30		7	8	10	12	15	20	25	30		7	8	10	12	15	20	25
08	1.5	2.26	387	339	271	226	181	136	108	90	194	170	136	113	90	68	54	45	129	113	90	75	60	45	36	30	
	2.0	2.61	447	392	313	261	209	157	125	104	224	196	157	131	104	78	63	52	149	131	104	87	70	52	42	35	
	2.5	2.92	501	438	350	292	234	175	140	117	250	219	175	146	117	88	70	58	167	146	117	97	78	58	47	39	
	3.0	3.20	549	480	384	320	256	192	154	128	274	240	192	160	128	96	77	64	183	160	128	107	85	64	51	43	
	4.0	3.70	634	555	444	370	296	222	178	148	317	278	222	185	148	111	89	74	211	185	148	123	99	74	59	49	
	5.0	4.00	686	600	480	400	320	240	192	160	343	300	240	200	160	120	96	80	229	200	160	133	107	80	64	53	
6.0	4.53	777	680	544	453	362	272	217	181	388	340	272	227	181	136	109	91	259	227	181	151	121	91	72	60		
10	1.5	2.80	480	420	336	280	224	168	134	112	240	210	168	140	112	84	67	56	160	140	112	93	75	56	45	37	
	2.0	3.30	566	495	396	330	264	198	158	132	283	248	198	165	132	99	79	66	189	165	132	110	88	66	53	44	
	2.5	3.70	634	555	444	370	296	222	178	148	317	278	222	185	148	111	89	74	211	185	148	123	99	74	59	49	
	3.0	4.00	686	600	480	400	320	240	192	160	343	300	240	200	160	120	96	80	229	200	160	133	107	80	64	53	
	4.0	4.60	789	690	552	460	368	276	221	184	394	345	276	230	184	138	110	92	263	230	184	153	123	92	74	61	
	5.0	5.20	891	780	624	520	416	312	250	208	446	390	312	260	208	156	125	104	297	260	208	173	139	104	83	69	
6.0	5.70	977	855	684	570	456	342	274	228	489	428	342	285	228	171	137	114	326	285	228	190	152	114	91	76		
15	1.5	4.20	720	630	504	420	336	252	202	168	360	315	252	210	168	126	101	84	240	210	168	140	112	84	67	56	
	2.0	4.90	840	735	588	490	392	294	235	196	420	368	294	245	196	147	118	98	280	245	196	163	131	98	78	65	
	2.5	5.50	943	825	660	550	440	330	264	220	471	413	330	275	220	165	132	110	314	275	220	183	147	110	88	73	
	3.0	6.00	1029	900	720	600	480	360	288	240	514	450	360	300	240	180	144	120	343	300	240	200	160	120	96	80	
	4.0	6.90	1183	1035	828	690	552	414	331	276	591	518	414	345	276	207	166	138	394	345	276	230	184	138	110	92	
	5.0	7.7	1320	1155	924	770	616	462	370	308	660	578	462	385	308	231	185	154	440	385	308	257	205	154	123	103	
6.0	8.5	1457	1275	1020	850	680	510	408	340	729	638	510	425	340	255	204	170	486	425	340	283	227	170	136	113		
20	1.5	5.70	977	855	684	570	456	342	274	228	489	428	342	285	228	171	137	114	326	285	228	190	152	114	91	76	
	2.0	6.50	1114	975	780	650	520	390	312	260	557	488	390	325	260	195	156	130	371	325	260	217	173	130	104	87	
	2.5	7.3	1251	1095	876	730	584	438	350	292	626	548	438	365	292	219	175	146	417	365	292	243	195	146	117	97	
	3.0	8.0	1371	1200	960	800	640	480	384	320	686	600	480	400	320	240	192	160	457	400	320	267	213	160	128	107	
	4.0	9.2	1577	1380	1104	920	736	552	442	368	789	690	552	460	368	276	221	184	526	460	368	307	245	184	147	123	
	5.0	10.3	1766	1545	1236	1030	824	618	494	412	883	773	618	515	412	309	247	206	589	515	412	343	275	206	165	137	
6.0	11.3	1937	1695	1356	1130	904	678	542	452	969	848	678	565	452	339	271	226	646	565	452	377	301	226	181	151		
30	1.5	8.5	1457	1275	1020	850	680	510	408	340	729	638	510	425	340	255	204	170	486	425	340	283	227	170	136	113	
	2.0	9.8	1680	1470	1176	980	784	588	470	392	840	735	588	490	392	294	235	196	560	490	392	327	261	196	157	131	
	2.5	11.0	1886	1650	1320	1100	880	660	528	440	943	825	660	550	440	330	264	220	629	550	440	367	293	220	176	147	
	3.0	12.0	2057	1800	1440	1200	960	720	576	480	1029	900	720	600	480	360	288	240	686	600	480	400	320	240	192	160	
	4.0	13.9	2383	2085	1668	1390	1112	834	667	556	1191	1043	834	695	556	417	334	278	794	695	556	463	371	278	222	185	
	5.0	15.5	2657	2325	1860	1550	1240	930	744	620	1329	1163	930	775	620	465	372	310	886	775	620	517	413	310	248	207	
6.0	17.0	2914	2550	2040	1700	1360	1020	816	680	1457	1275	1020	850	680	510	408	340	971	850	680	567	453	340	272	227		
40	1.5	11.3	1937	1695	1356	1130	904	678	542	452	969	848	678	565	452	339	271	226	646	565	452	377	301	226	181	151	
	2.0	13.1	2246	1965	1572	1310	1048	786	629	524	1123	983	786	655	524	393	314	262	749	655	524	437	349	262	210	175	
	2.5	14.6	2503	2190	1752	1460	1168	876	701	584	1251	1095	876	730	584	438	350	292	834	730	584	487	389	292	234	195	
	3.0	16.0	2743	2400	1920	1600	1280	960	768	640	1371	1200	960	800	640	480	384	320	914	800	640	533	427	320	256	213	
	4.0	18.5	3171	2775	2220	1850	1480	1110	888	740	1586	1388	1110	925	740	555	444	370	1057	925	740	617	493	370	296	247	
	5.0	20.7	3549	3105	2484	2070	1656	1242	994	828	1774	1553	1242	1035	828	621	497	414	1183	1035	828	690	552	414	331	276	
6.0	22.6	3874	3390	2712	2260	1808	1356	1085	904	1937	1695	1356	1130	904	678	542	452	1291	1130	904	753	603	452	362	301		
50	1.5	14.1	2417	2115	1692	1410	1128	846	677	564	1209	1058	846	705	564	423	338	282	806	705	564	470	376	282	226	188	
	2.0	16.3	2794	2445	1956	1630	1304	978	782	652	1397	1223	978	815	652	489	391	326	931	815	652	543	435	326	261	217	
	2.5	18.3	3137	2745	2196	1830	1464	1098	878	732	1569	1373	1098	915	732	549	439	366	1046	915	732	610	488	366	293	244	
	3.0	20.0	3429	3000	2400	2000	1600	1200	960	800	1714	1500	1200	1000	800	600	480	400	1143	1000	800	667	533	400	320	267	
	4.0	23.1	3960	3465	2702	2310	1848	1386	1109	924	1981	1733	1386	1155	924	693	554	462	1320	1155	924	770	616	462	370	308	
	5.0	25.8	4423	3870	3096	2580	2064	1548	1238	1032	2211	1935	1548	1290	1032	774	619	516	1474	1290	1032	860	688	516	413	344	
6.0	28.3	4851	4245	3396	2830	2264	1698	1358	1132	2426	2123	1698	1415	1132	849	679	566	1617	1415	1132	943	755	566	453	377		
60	1.5	17.0	2914	2550	2040	1700	1360	1020	816	680	1457	1275	1020	850	680	510	408	340	971	850	680	567	453	340	272	227	
	2.0	19.6	3360	2940	2352	1960	1568	1176	941	784	1680	1470	1176	980	784	588	470	392	1120	980	784	653	523	392	314	261	
	2.5	21.9	3754	3285	2628	2190	1752	1314	1051	876	1877	1643	1314	1095	876	657	526	438	1251	1095	876	730	584	438	350	292	
	3.0	24.0	4114	3600	2880	2400	1920	1440	1152	960	2057	1800	1440	1200	960	720	576	480	1371	1200	960	800	640	480	384	320	
	4.0	27.7	4749	4155	3324	2770	2216	1662	1330	1108	2374																

TURF APPLICATION CHART - 20" SPACING

Nozzle Size	Pressure (PSI)	Flow Rate (GPM)	GAL/1000 Ft ² 20 inch nozzle							
			MPH							
			2	3	4	5	6	7	8	
01	15	0.06	0.21	0.14	0.10	0.08	0.07	0.06	0.05	
	30	0.09	0.30	0.20	0.15	0.12	0.10	0.08	0.07	
	40	0.10	0.34	0.23	0.17	0.14	0.11	0.10	0.09	
	60	0.12	0.42	0.28	0.21	0.17	0.14	0.12	0.10	
	80	0.14	0.48	0.32	0.24	0.19	0.16	0.14	0.12	
	100	0.16	0.54	0.36	0.27	0.22	0.18	0.15	0.13	
115	0.17	0.58	0.39	0.29	0.23	0.19	0.17	0.14		
015	15	0.09	0.31	0.21	0.16	0.13	0.10	0.09	0.08	
	30	0.13	0.44	0.30	0.22	0.18	0.15	0.13	0.11	
	40	0.15	0.51	0.34	0.26	0.20	0.17	0.15	0.13	
	60	0.18	0.63	0.42	0.31	0.25	0.21	0.18	0.16	
	80	0.21	0.72	0.48	0.36	0.29	0.24	0.21	0.18	
	100	0.24	0.81	0.54	0.40	0.32	0.27	0.23	0.20	
115	0.25	0.87	0.58	0.43	0.35	0.29	0.25	0.22		
02	15	0.12	0.42	0.28	0.21	0.17	0.14	0.12	0.10	
	30	0.17	0.59	0.39	0.30	0.24	0.20	0.17	0.15	
	40	0.20	0.68	0.45	0.34	0.27	0.23	0.19	0.17	
	60	0.24	0.84	0.56	0.42	0.33	0.28	0.24	0.21	
	80	0.28	0.96	0.64	0.48	0.39	0.32	0.28	0.24	
	100	0.32	1.08	0.72	0.54	0.43	0.36	0.31	0.27	
115	0.34	1.16	0.77	0.58	0.46	0.39	0.33	0.29		
025	15	0.15	0.52	0.35	0.26	0.21	0.17	0.15	0.13	
	30	0.22	0.74	0.49	0.37	0.30	0.25	0.21	0.18	
	40	0.25	0.85	0.57	0.43	0.34	0.28	0.24	0.21	
	60	0.31	1.04	0.70	0.52	0.42	0.35	0.30	0.26	
	80	0.35	1.21	0.80	0.60	0.48	0.40	0.34	0.30	
	100	0.40	1.35	0.90	0.67	0.54	0.45	0.39	0.34	
115	0.42	1.45	0.96	0.72	0.58	0.48	0.41	0.36		
03	15	0.18	0.63	0.42	0.31	0.25	0.21	0.18	0.16	
	30	0.26	0.89	0.59	0.44	0.35	0.30	0.25	0.22	
	40	0.30	1.02	0.68	0.51	0.41	0.34	0.29	0.26	
	60	0.37	1.25	0.84	0.63	0.50	0.42	0.36	0.31	
	80	0.42	1.45	0.96	0.72	0.58	0.48	0.41	0.36	
	100	0.47	1.62	1.08	0.81	0.65	0.54	0.46	0.40	
115	0.51	1.73	1.16	0.87	0.69	0.58	0.50	0.43		
035	15	0.21	0.73	0.49	0.37	0.29	0.24	0.21	0.18	
	30	0.30	1.03	0.69	0.52	0.41	0.34	0.30	0.26	
	40	0.35	1.19	0.80	0.60	0.48	0.40	0.34	0.30	
	60	0.43	1.46	0.97	0.73	0.58	0.49	0.42	0.37	
	80	0.49	1.69	1.13	0.84	0.68	0.56	0.48	0.42	
	100	0.55	1.89	1.26	0.94	0.75	0.63	0.54	0.47	
115	0.59	2.02	1.35	1.01	0.81	0.67	0.58	0.51		
04	15	0.24	0.84	0.56	0.42	0.33	0.28	0.24	0.21	
	30	0.35	1.18	0.79	0.59	0.47	0.39	0.34	0.30	
	40	0.40	1.36	0.91	0.68	0.55	0.45	0.39	0.34	
	60	0.49	1.67	1.11	0.84	0.67	0.56	0.48	0.42	
	80	0.57	1.93	1.29	0.96	0.77	0.64	0.55	0.48	
	100	0.63	2.16	1.44	1.08	0.86	0.72	0.62	0.54	
115	0.68	2.31	1.54	1.16	0.93	0.77	0.66	0.58		
05	15	0.31	1.04	0.70	0.52	0.42	0.35	0.30	0.26	
	30	0.43	1.48	0.98	0.74	0.59	0.49	0.42	0.37	
	40	0.50	1.71	1.14	0.85	0.68	0.57	0.49	0.43	
	60	0.61	2.09	1.39	1.04	0.84	0.70	0.60	0.52	
	80	0.71	2.41	1.61	1.21	0.96	0.80	0.69	0.60	
	100	0.79	2.70	1.80	1.35	1.08	0.90	0.77	0.67	
115	0.85	2.89	1.93	1.45	1.16	0.96	0.83	0.72		
06	15	0.37	1.25	0.84	0.63	0.50	0.42	0.36	0.31	
	30	0.52	1.77	1.18	0.89	0.71	0.59	0.51	0.44	
	40	0.60	2.05	1.36	1.02	0.82	0.68	0.58	0.51	
	60	0.73	2.51	1.67	1.25	1.00	0.84	0.72	0.63	
	80	0.85	2.89	1.93	1.45	1.16	0.96	0.83	0.72	
	100	0.95	3.24	2.16	1.62	1.29	1.08	0.92	0.81	
115	1.02	3.47	2.31	1.73	1.39	1.16	0.99	0.87		
08	15	0.49	1.67	1.11	0.84	0.67	0.56	0.48	0.42	
	30	0.69	2.36	1.58	1.18	0.95	0.79	0.68	0.59	
	40	0.80	2.73	1.82	1.36	1.09	0.91	0.78	0.68	
	60	0.98	3.34	2.23	1.67	1.34	1.11	0.95	0.84	
	80	1.13	3.86	2.57	1.93	1.54	1.29	1.10	0.96	
	100	1.26	4.31	2.88	2.16	1.73	1.44	1.23	1.08	
115	1.36	4.63	3.08	2.31	1.85	1.54	1.32	1.16		
10	15	0.61	2.09	1.39	1.04	0.84	0.70	0.60	0.52	
	30	0.87	2.95	1.97	1.48	1.18	0.98	0.84	0.74	
	40	1.00	3.41	2.27	1.71	1.36	1.14	0.97	0.85	
	60	1.22	4.18	2.78	2.09	1.67	1.39	1.19	1.04	
	80	1.41	4.82	3.21	2.41	1.93	1.61	1.38	1.21	
	100	1.58	5.39	3.59	2.70	2.16	1.80	1.54	1.35	
115	1.70	5.78	3.85	2.89	2.31	1.93	1.65	1.45		
15	15	0.92	3.13	2.09	1.57	1.25	1.04	0.89	0.78	
	30	1.30	4.43	2.95	2.21	1.77	1.48	1.27	1.11	
	40	1.50	5.12	3.41	2.56	2.05	1.71	1.46	1.28	
	60	1.84	6.26	4.18	3.13	2.51	2.09	1.79	1.57	
	80	2.12	7.23	4.82	3.62	2.89	2.41	2.07	1.81	
	100	2.37	8.09	5.39	4.04	3.24	2.70	2.31	2.02	
115	2.54	8.67	5.78	4.34	3.47	2.89	2.48	2.17		
20	20	1.41	4.82	3.21	2.41	1.93	1.61	1.38	1.21	
	30	1.75	5.91	3.94	2.95	2.36	1.97	1.69	1.48	
	40	2.00	6.82	4.55	3.41	2.73	2.27	1.95	1.71	
	50	2.24	7.62	5.08	3.81	3.05	2.54	2.18	1.91	
	60	2.45	8.35	5.57	4.18	3.34	2.78	2.39	2.09	
	70	2.65	9.02	6.01	4.51	3.61	3.01	2.58	2.26	
80	2.83	9.64	6.43	4.82	3.86	3.21	2.76	2.41		
30	20	2.12	7.23	4.82	3.62	2.89	2.41	2.07	1.81	
	30	2.60	8.86	5.91	4.43	3.54	2.95	2.53	2.21	
	40	3.00	10.23	6.82	5.12	4.09	3.41	2.92	2.56	
	50	3.35	11.44	7.62	5.72	4.57	3.81	3.27	2.86	
	60	3.67	12.53	8.35	6.26	5.01	4.18	3.58	3.13	
	70	3.97	13.53	9.02	6.77	5.41	4.51	3.87	3.38	
80	4.24	14.47	9.64	7.23	5.79	4.82	4.13	3.62		
40	20	2.83	9.64	6.43	4.82	3.86	3.21	2.76	2.41	
	30	3.46	11.81	7.88	5.91	4.73	3.94	3.38	2.95	
	40	4.00	13.64	9.09	6.82	5.46	4.55	3.90	3.41	
	50	4.47	15.25	10.17	7.62	6.01	5.02	4.36	3.81	
	60	4.90	16.71	11.14	8.35	6.68	5.57	4.77	4.18	
	70	5.29	18.04	12.03	9.02	7.22	6.01	5.16	4.51	
80	5.66	19.29	12.86	9.64	7.72	6.43	5.51	4.82		
50	20	3.54	12.06	8.04	6.03	4.82	4.02	3.44	3.01	
	30	4.33	14.77	9.84	7.38	5.91	4.92	4.22	3.69	
	40	5.00	17.05	11.37	8.53	6.82	5.68	4.87	4.26	
	50	5.59	19.06	12.71	9.53	7.62	6.35	5.45	4.77	
	60	6.12	20.88	13.92	10.44	8.35	6.96	5.97	5.22	
	70	6.61	22.56	15.04	11.28	9.02	7.52	6.44	5.64	
80	7.07	24.11	16.07	12.06	9.64	8.04	6.89	6.03		
60	20	4.24	14.47	9.64	7.23	5.79	4.82	4.13	3.62	
	30	5.20	17.72	11.81	8.86	7.09	5.91	5.06	4.43	
	40	6.00	20.46	13.64	10.23	8.18	6.82	5.85	5.12	
	50	6.71	22.87	15.25	11.44	9.15	7.62	6.54	5.72	
	60	7.35	25.06	16.71	12.53	10.02	8.35	7.16	6.26	
	70	7.94	27.07	18.04	13.53	10.83	9.02	7.73	6.77	
80	8.49	28.93	19.29	14.47	11.57	9.64	8.27	7.23		

TURF APPLICATION CHART-15" SPACING

Nozzle Size	Pressure (PSI)	Flow Rate (GPM)	GAL/1000 Ft ² 15 inch nozzle							
			MPH							
			2	3	4	5	6	7	8	
01	15	0.06	0.28	0.19	0.14	0.11	0.09	0.08	0.07	
	30	0.09	0.39	0.26	0.20	0.16	0.13	0.11	0.10	
	40	0.10	0.45	0.30	0.23	0.18	0.15	0.13	0.11	
	60	0.12	0.56	0.37	0.28	0.22	0.19	0.16	0.14	
	80	0.14	0.64	0.43	0.32	0.25	0.21	0.18	0.16	
	100	0.16	0.72	0.48	0.36	0.29	0.24	0.21	0.18	
115	0.17	0.77	0.51	0.39	0.31	0.26	0.22	0.19		
015	15	0.09	0.42	0.28	0.21	0.17	0.14	0.12	0.10	
	30	0.13	0.59	0.39	0.30	0.24	0.20	0.17	0.15	
	40	0.15	0.68	0.45	0.34	0.27	0.23	0.19	0.17	
	60	0.18	0.84	0.56	0.42	0.33	0.28	0.24	0.21	
	80	0.21	0.96	0.64	0.48	0.39	0.32	0.28	0.24	
	100	0.24	1.08	0.72	0.54	0.43	0.36	0.31	0.27	
115	0.25	1.16	0.77	0.58	0.46	0.39	0.33	0.29		
02	15	0.12	0.56	0.37	0.28	0.22	0.19	0.16	0.14	
	30	0.17	0.79	0.53	0.39	0.32	0.26	0.23	0.20	
	40	0.20	0.91	0.61	0.46	0.36	0.30	0.26	0.23	
	60	0.24	1.11	0.74	0.56	0.45	0.37	0.32	0.28	
	80	0.28	1.29	0.86	0.64	0.51	0.43	0.37	0.32	
	100	0.32	1.44	0.96	0.72	0.58	0.48	0.41	0.36	
115	0.34	1.54	1.03	0.77	0.62	0.51	0.44	0.39		
025	15	0.15	0.70	0.46	0.35	0.28	0.23	0.20	0.17	
	30	0.22	0.98	0.66	0.49	0.39	0.33	0.28	0.25	
	40	0.25	1.14	0.76	0.57	0.45	0.38	0.32	0.28	
	60	0.31	1.39	0.93	0.70	0.56	0.46	0.40	0.35	
	80	0.35	1.61	1.07	0.80	0.64	0.54	0.46	0.40	
	100	0.40	1.80	1.20	0.90	0.72	0.60	0.51	0.45	
115	0.42	1.93	1.28	0.96	0.77	0.64	0.55	0.48		
03	15	0.18	0.84	0.56	0.42	0.33	0.28	0.24	0.21	
	30	0.26	1.18	0.79	0.59	0.47	0.39	0.34	0.30	
	40	0.30	1.36	0.91	0.68	0.55	0.46	0.39	0.34	
	60	0.37	1.67	1.11	0.84	0.67	0.56	0.48	0.42	
	80	0.42	1.93	1.29	0.96	0.77	0.64	0.55	0.48	
	100	0.47	2.16	1.44	1.08	0.86	0.72	0.62	0.54	
115	0.51	2.31	1.54	1.16	0.93	0.77	0.66	0.58		
035	15	0.21	0.97	0.65	0.49	0.39	0.32	0.28	0.24	
	30	0.30	1.38	0.92	0.69	0.55	0.46	0.39	0.34	
	40	0.35	1.59	1.06	0.80	0.64	0.53	0.45	0.40	
	60	0.43	1.95	1.30	0.97	0.78	0.65	0.56	0.49	
	80	0.49	2.25	1.50	1.13	0.90	0.75	0.64	0.56	
	100	0.55	2.52	1.68	1.26	1.01	0.84	0.72	0.63	
115	0.58	2.70	1.80	1.35	1.08	0.90	0.77	0.67		
04	15	0.24	1.11	0.74	0.56	0.45	0.37	0.32	0.28	
	30	0.35	1.58	1.05	0.79	0.63	0.53	0.45	0.39	
	40	0.40	1.82	1.21	0.91	0.73	0.61	0.52	0.45	
	60	0.49	2.23	1.48	1.11	0.89	0.74	0.64	0.56	
	80	0.57	2.57	1.71	1.29	1.03	0.86	0.73	0.64	
	100	0.63	2.88	1.92	1.44	1.15	0.96	0.82	0.72	
115	0.68	3.08	2.06	1.54	1.23	1.03	0.88	0.77		
05	15	0.31	1.39	0.93	0.70	0.58	0.46	0.40	0.35	
	30	0.43	1.97	1.31	0.98	0.79	0.66	0.56	0.49	
	40	0.50	2.27	1.52	1.14	0.91	0.76	0.65	0.57	
	60	0.61	2.78	1.86	1.39	1.11	0.93	0.80	0.70	
	80	0.71	3.21	2.14	1.61	1.29	1.07	0.92	0.80	
	100	0.79	3.59	2.40	1.80	1.44	1.20	1.03	0.90	
115	0.85	3.85	2.57	1.93	1.54	1.28	1.10	0.96		
06	15	0.37	1.67	1.11	0.84	0.67	0.56	0.48	0.42	
	30	0.52	2.36	1.58	1.18	0.95	0.79	0.68	0.59	
	40	0.60	2.73	1.82	1.36	1.09	0.91	0.78	0.68	
	60	0.73	3.34	2.23	1.67	1.34	1.11	0.95	0.84	
	80	0.85	3.86	2.57	1.93	1.54	1.29	1.10	0.96	
	100	0.95	4.31	2.88	2.16	1.73	1.44	1.23	1.08	
115	1.02	4.63	3.08	2.31	1.85	1.54	1.32	1.16		
08	15	0.49	2.23	1.48	1.11	0.89	0.74	0.64	0.56	
	30	0.69	3.15	2.10	1.58	1.26	1.05	0.90	0.79	
	40	0.80	3.64	2.42	1.82	1.45	1.21	1.04	0.91	
	60	0.98	4.45	2.97	2.23	1.78	1.48	1.27	1.11	
	80	1.13	5.14	3.43	2.57	2.06	1.71	1.47	1.29	
	100	1.26	5.75	3.83	2.88	2.30	1.92	1.64	1.44	
115	1.36	6.17	4.11	3.08	2.47	2.06	1.76	1.54		
10	15	0.61	2.78	1.86	1.39	1.11	0.93	0.80	0.70	
	30	0.87	3.94	2.63	1.97	1.58	1.31	1.13	0.98	
	40	1.00	4.55	3.03	2.27	1.82	1.52	1.30	1.14	
	60	1.22	5.57	3.71	2.78	2.23	1.86	1.59	1.39	
	80	1.41	6.43	4.29	3.21	2.57	2.14	1.84	1.61	
	100	1.58	7.19	4.79	3.59	2.88	2.40	2.05	1.80	
115	1.70	7.71	5.14	3.85	3.08	2.57	2.20	1.93		
15	15	0.92	4.18	2.78	2.09	1.67	1.39	1.19	1.04	
	30	1.30	5.91	3.94	2.95	2.36	1.97	1.69	1.48	
	40	1.50	6.82	4.55	3.41	2.73	2.27	1.95	1.71	
	60	1.84	8.35	5.57	4.18	3.34	2.78	2.39	2.09	
	80	2.12	9.64	6.43	4.82	3.86	3.21	2.76	2.41	
	100	2.37	10.78	7.19	5.39	4.31	3.59	3.08	2.70	
115	2.54	11.56	7.71	5.78	4.63	3.85	3.30	2.89		
20	20	1.41	6.43	4.29	3.21	2.57	2.14	1.84	1.61	
	30	1.73	7.88	5.25	3.94	3.15	2.63	2.25	1.97	
	40	2.00	9.09	6.06	4.55	3.64	3.03	2.60	2.27	
	50	2.24	10.17	6.78	5.08	4.07	3.39	2.90	2.54	
	60	2.45	11.14	7.42	5.57	4.45	3.71	3.18	2.78	
	70	2.65	12.03	8.02	6.01	4.81	4.01	3.44	3.01	
80	2.83	12.86	8.57	6.43	5.14	4.29	3.67	3.21		
30	20	2.12	9.64	6.43	4.82	3.86	3.21	2.76	2.41	
	30	2.60	11.81	7.88	5.91	4.73	3.94	3.38	2.95	
	40	3.00	13.64	9.09	6.82	5.46	4.55	3.90	3.41	
	50	3.35	15.25	10.17	7.62	6.10	5.08	4.36	3.81	
	60	3.67	16.71	11.14	8.35	6.68	5.57	4.77	4.18	
	70	3.97	18.04	12.03	9.02	7.22	6.01	5.16	4.51	
80	4.24	19.29	12.86	9.64	7.72	6.43	5.51	4.82		
40	20	2.83	12.86	8.57	6.43	5.14	4.29	3.67	3.21	
	30	3.46	15.75	10.50	7.88	6.30	5.25	4.50	3.94	
	40	4.00	18.19	12.12	9.09	7.27	6.06	5.20	4.55	
	50	4.47	20.33	13.56	10.17	8.13	6.78	5.81	5.08	
	60	4.90	22.27	14.85	11.14	8.91	7.42	6.36	5.57	
	70	5.29	24.06	16.04	12.03	9.62	8.02	6.87	6.01	
80	5.66	25.72	17.15	12.86	10.29	8.57	7.35	6.43		
50	20	3.54	16.07	10.72	8.04	6.43	5.36	4.59	4.02	
	30	4.33	19.69	13.13	9.84	7.88	6.56	5.63	4.92	
	40	5.00	22.73	15.16	11.37	9.09	7.58	6.50	5.68	
	50	5.59	25.42	16.94	12.71	10.17	8.47	7.26	6.35	
	60	6.12	27.84	18.56	13.92	11.14	9.28	7.96	6.96	
	70	6.61	30.07	20.05	15.04	12.03	10.02	8.59	7.52	
80	7.07	32.15	21.43	16.07	12.86	10.72	9.19	8.04		
60	20	4.24	19.29	12.86	9.64	7.72	6.43	5.51	4.82	
	30	5.20	23.63	15.75	11.81	9.45	7.88	6.75	5.91	
	40	6.00	27.28	18.19	13.64	10.91	9.09	7.79	6.82	
	50	6.71	30.50	20.33	15.25	12.20	10.17	8.71	7.62	
	60	7.35	33.41	22.27	16.71	13.36	11.14	9.55	8.35	
	70	7.94	36.09	24.06	18.04	14.44	12.03	10.31	9.02	
80	8.49	38.58	25.72	19.29	15.43	12.86	11.02	9.64		

SPACING, HEIGHT, & CONVERSION TABLES

SUGGESTED MINIMUM BROADCAST SPRAY HEIGHTS (FLAT FAN SPARY NOZZLES)

Spray Angle		15" (40 cm) Spacing	20" (50 cm) Spacing	30" (75 cm) Spacing	40" (100 cm) Spacing
80°	Standard	13" - 14"	17" - 19"	26" - 28"	NR*
	Metric	33 - 36 cm	43 - 48 cm	66- 71 cm	NR*
110°	Standard	10" - 11"	15" - 18"	20" - 22"	NR*
	Metric	25 - 28 cm	38 - 46 cm	51 - 56 cm	NR*
120°	Standard	8" - 10"	12" - 15"	16" - 20"	24" - 30"
	Metric	20 - 25 cm	30 - 38 cm	41 - 52 cm	61 - 76 cm
140°	Standard	5" - 7"	7" -9"	10" -14"	24" - 30"
	Metric	20 - 25 cm	30 - 38 cm	41 - 52 cm	61 - 76 cm

* Not Recommended

** 40" nozzle spacing is prone to off-target trespass under certain conditions that affect drift.

OPTIMUM BROADCAST SPRAY HEIGHTS (FLAT FAN SPRAY NOZZLES)

Spray Angle		15" (40 cm) Spacing	20" (50 cm) Spacing	30" (75 cm) Spacing	40" (100 cm) Spacing
80°	Standard	22"	30"	43"	NR*
	Metric	56 cm	76 cm	109 cm	NR*
110°	Standard	15"	20"	30"	NR*
	Metric	38 cm	51 cm	76 cm	NR*
120°	Standard	13"	18"	28"	38"
	Metric	33 cm	46 cm	71 cm	97 cm
140°	Standard	10"	12"	16"	22"
	Metric	25 cm	30 cm	40 cm	55 cm

NOZZLE SPACING

If your nozzle spacing differs from the spacing used in spray nozzle application rate tables, multiply the tabulated GPA by the conversion factor to find your actual application rate.

Example: If your nozzle spacing is actually 36-inches (90cm), your application rate will be 0.56 times what is shown in tables for nozzles spaced 20-inches (50cm).

To calculate a conversion factor for spacing not listed below, use the following formula:

$$\text{Standard Conversion Factor} = \frac{\text{Nozzle Spacing in Table (inches)}}{\text{Your Nozzle Spacing (inches)}}$$

$$\text{Metric Conversion Factor} = \frac{\text{Nozzle Spacing in Table (cm)}}{\text{Your Nozzle Spacing (cm)}}$$

US UNITS

Your Spacing	Conversion from Charts		
	20 in	30 in	40 in
8 in	2.50	3.75	5.00
10 in	2.00	3.00	4.00
12 in	1.67	2.50	3.33
14 in	1.43	2.14	2.86
16 in	1.33	2.00	2.67
18 in	1.25	1.88	2.50
20 in	1.11	1.67	2.22
22 in	1.00	1.50	2.00
24 in	0.83	1.25	1.67
26 in	0.77	1.15	1.54
28 in	0.71	1.07	1.43
30 in	0.67	1.00	1.33
32 in	0.63	0.94	1.25
34 in	0.59	0.88	1.18
36 in	0.56	0.83	1.11
38 in	0.53	0.79	1.05
40 in	0.50	0.75	1.00
42 in	0.48	0.71	0.91
44 in	0.45	0.68	0.91
48 in	0.42	0.63	0.83

METRIC UNITS

Your Spacing	Conversion from Charts		
	50 cm	75 cm	100 cm
10 cm	5.00	7.50	10.00
15 cm	3.33	5.00	6.67
20 cm	2.50	3.75	5.00
25 cm	2.00	3.00	4.00
30 cm	1.67	2.50	3.33
33 cm	1.52	2.27	3.03
40 cm	1.25	1.88	2.50
45 cm	1.11	1.67	2.22
50 cm	1.00	1.50	2.00
55 cm	0.91	1.36	1.82
60 cm	0.83	1.25	1.67
65 cm	0.77	1.15	1.54
70 cm	0.71	1.07	1.43
75 cm	0.67	1.00	1.33
80 cm	0.63	0.94	1.25
85 cm	0.59	0.88	1.18
90 cm	0.56	0.83	1.11
95 cm	0.53	0.79	1.05
100 cm	0.50	0.75	1.00
110 cm	0.45	0.68	0.91
120 cm	0.42	0.63	0.83

SPRAYING SOLUTIONS OTHER THAN WATER

Liquids that are more dense than water will flow through a spray nozzle more slowly than water. Solutions that are less dense than water will flow through a spray nozzle more quickly than water. Unless otherwise indicated, the performance tables in the spray nozzle section of this catalog show flow and application rates for water-based sprays. To use those tables when selecting nozzles to apply non-water sprays you must calculate an intermediate "look-up" application rate. To do this you will multiply your actual desired application rate by a conversion factor and then use the resulting "look-up" figure to select a nozzle from the water-based performance tables. The conversion factors listed on this page are based on typical values for common fertilizer solutions. For other spray solutions, you can calculate the conversion factor by taking the square root of the solution's specific gravity.

For easier nozzle selection using water and non-water sprays, use the Spray It calculator online at: pentair.com

U.S. UNITS

Density (lb/us gal)	Material	Specific Gravity	Conversion Factor
7.00		0.84	0.92
8.00		0.96	0.98
8.34	water	1.00	1.00
9.00		1.08	1.04
10.00		1.20	1.10
10.30	4-10-10	1.24	1.11
10.65	28-0-0	1.28	1.13
11.00		1.32	1.15
11.05	32-0-0	1.32	1.15
11.20	7-21-7	1.34	1.16
11.65	10-34-0	1.40	1.18
12.00		1.44	1.20

METRIC

Density (kg/L)	Material	Conversion Factor
0.80		0.89
0.90		0.95
1.00	water	1.00
1.10		1.05
1.20		1.10
1.24	4-10-10	1.11
1.28	28-0-0	1.13
1.30		1.14
1.32	32-0-0	1.15
1.34	7-21-7	1.16
1.40	10-34-0	1.18
1.50		1.22

EXAMPLE:

Your desired application rate of 28% Nitrogen fertilizer (28-0-0) is 30 US GPA.

Multiply 30 GPA by Conversion Factor 1.13 to find the converted look-up application rate of 33.9 GPA.

Select a spray nozzle that will apply 33.9 GPA of water-based spray. A spray nozzle that will apply 33.9 GPA of water will apply 30 GPA of 28-0-0 fertilizer solution.

EXAMPLE:

Your desired application rate of 28% Nitrogen fertilizer (28-0-0) is 300 L/ha.

Multiply 300 L/ha X Conversion Factor 1.13 to find the converted look-up application rate of 339 L/ha.

Select a spray nozzle that will apply 339 L/ha of water-based spray. A spray nozzle that will apply 339 L/ha of water will apply 300 L/ha of 28-0-0 fertilizer solution.

BROADCAST APPLICATION FORMULAS

US STANDARD

Application Formulas - US Standard

GPM - Gallons per minute (per spray nozzle)

GPA - Gallons per acre

GAL/1000FT² - Gallons per 1000 square feet

MPH - Miles per hour

W - Nozzle spacing (inches) for broadcast spraying

- Spray width (inches) for single-nozzle band

spraying or boomless spraying

- Row spacing (inches) divided by the number of nozzles per row for directed spraying

METRIC

Application Formulas - Metric

LPM - Litres per minute (per spray nozzle)

L/ha - Litres per hectare

Kmph - Kilometres per hour

W - Nozzle spacing (m) for broadcast spraying

- Spray width (m) for single-nozzle band spraying or boomless spraying

- Row spacing (m) divided by the number of nozzles per row for directed spraying

BAND SPRAYING APPLICATION FORMULAS

US STANDARD

$$\text{Volume of Chemical Solution Required in Gallons} = \frac{\text{Band Width (inches)}}{[\text{Band Width} + \text{Spacing between Bands}] \text{ (inches)}}$$

$$\text{Label Rate of Carrier (GPA)} \times \text{Field Area (Acres)}$$

HEIGHT REQUIREMENT - BAND SPRAYING

Band Width	Height over Target 80°	Height over Target 110°
8"	5"	3"
10"	6"	4"
12"	7"	4"
15"	9"	5"
18"	11"	6"
20"	12"	7"
30"	18"	11"

To find GPA in the band, use the following equation:

$$\text{Band GPA} = \frac{5940 \times \text{GPM} \times \text{N}}{\text{MPH} \times \text{W}}$$

GPM needed per Nozzle:

$$\text{GPM} = \frac{\text{GPA} \times \text{MPH} \times \text{W}}{5940 \times \text{N}}$$

TREATED AREA PER FIELD FOR BANDING APPLICATIONS

Row Spacing in Inches	Band Width						
	7"	8"	10"	12"	15"	20"	24"
20"	0.350	0.400	0.500	0.600	0.75	1.000	
22"	0.318	0.363	0.454	0.545	0.681	0.909	
30"	0.233	0.266	0.333	0.400	0.500	0.666	0.800
36"	0.194	0.222	0.278	0.333	0.416	0.555	0.666
40"	0.175	0.200	0.250	0.300	0.375	0.500	0.600
48"	0.145	0.166	0.208	0.250	0.321	0.417	0.500

GPA = Gallons per acre
 GPM = Gallons per minute
 MPH = Speed in miles per hour
 W = Band width in inches
 N = Number of nozzles spraying each band

METRIC

$$\text{Volume of Chemical Solution Required in Litres} = \frac{\text{Band Width (m)}}{[\text{Band Width} + \text{Spacing between Bands}] \text{ (m)}}$$

$$\text{Label Rate of Carrier (L/ha)} \times \text{Field Area (ha)}$$

HEIGHT REQUIREMENT - BAND SPRAYING

Band Width	Height over Target 80°	Height over Target 110°
20 cm	12 cm	7 cm
25 cm	15 cm	9 cm
30 cm	18 cm	11 cm
40 cm	24 cm	14 cm
45 cm	27 cm	16 cm
50 cm	30 cm	18 cm
75 cm	45 cm	26 cm

To find the L/ha in the band, use the following equation:

$$\text{Band L/ha} = \frac{600 \times \text{LPM} \times \text{N}}{\text{Kmph} \times \text{W}}$$

LPM needed per Nozzle:

$$\text{LPM} = \frac{\text{L/ha} \times \text{Kmph} \times \text{W}}{600 \times \text{N}}$$

TREATED AREA PER FIELD FOR BANDING APPLICATIONS

Row Spacing in cm	Band Width						
	18 cm	20 cm	25 cm	30 cm	38 cm	50 cm	60 cm
50 cm	0.360	0.400	0.500	0.600	0.760	1.000	
60 cm	0.300	0.333	0.417	0.500	0.633	0.833	1.000
75 cm	0.240	0.267	0.333	0.400	0.507	0.667	0.800
90 cm	0.200	0.222	0.278	0.333	0.422	0.556	0.667
100 cm	0.180	0.200	0.250	0.300	0.380	0.500	0.600
120 cm	0.150	0.167	0.208	0.250	0.317	0.417	0.500

L/ha = Litres per hectare
 LPM = Litres per minute
 Kmph = Speed in kilometres per hour
 W = Band width in metres
 N = Number of nozzles spraying each band

WEAR AND CHEMICAL COMPATIBILITY

Ceramic – Highly resistant to abrasive and corrosive chemistry and provides superior wear resistance in abrasive applications and high pressures. Albus nozzle orifices are made of pink inserted ceramic, reinforced by special oxides, and specially designed by Saint-Gobain for spraying applications.

Polyacetal – Provides good resistance to most chemicals and superior wear resistance to most agricultural chemistry. Susceptible to strong mineral acids and a few organic solvents. Resistance to most alkalis is excellent. Organic solvents usually cause slight swelling without any other harmful effect.*

Polyvinylidene Fluoride (PVDF) – Should be used with acid-based agricultural defoliation chemistry. Good resistance to wear.* Resists many reagents and high temperatures (up to 300°F). Susceptible to high temperatures above water boiling (210°F) in combination with concentrated sulfuric and nitric acids. Preferred in industrial spraying applications.

Stainless Steel – Good resistance to chemicals and provides average wear resistance.

Brass – Average resistance to most chemistry and poor wear resistance. Susceptible to corrosion, especially with fertilizers.

Hypro's Technical/Application Department is available to answer chemical compatibility issues and assist in choosing the correct spray nozzle for your application. Call 1-800-445-8360 (US) or +44 1954 260097 (Europe).

* A list of resistant reagents, acids and alkaline is available from the Hypro Technical/Application Department.

COMPARATIVE ACCELERATED WEAR TEST

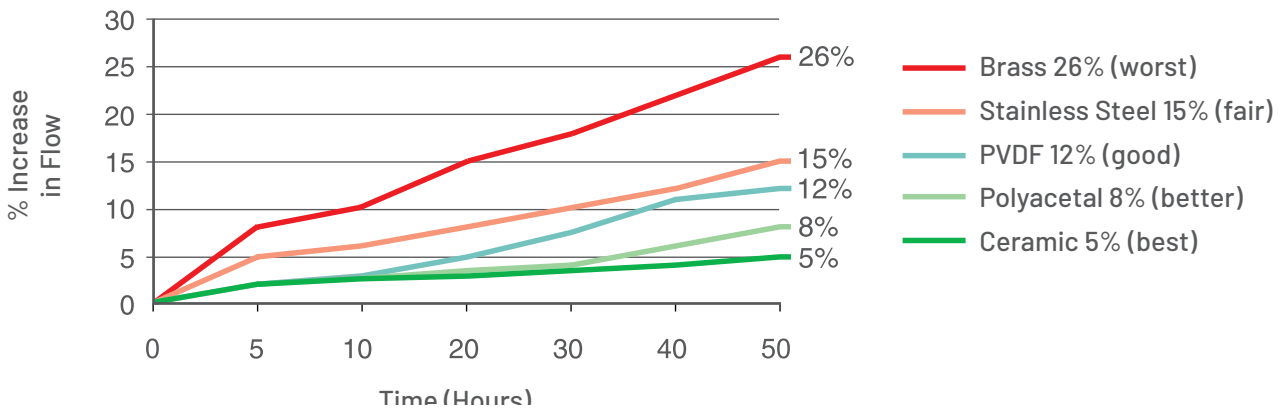

Source: SGS UK LTD. Saint-Gobain AC France
 Test Medium: 2.5% Kaolin in water
 Test Pressure: 40 psi

TEMPERATURE TOLERANCE

Nozzle Material	Maximum Temperature	
PVC	58° C	136° F
Polyacetal	85° C	185° F
PVDF	150° C	302° F
Brass	234° C	453° F
Stainless Steel	430° C	806° F

SPRAY NOZZLE MAINTENANCE AND INFORMATION GUIDE

Spraying with a worn nozzle will have consequences for precision. Firstly, droplet size will be larger risking compromised spray coverage and uneven spray across the boom. If the sprayer is not fitted with a rate controller it will also mean uneven over application, this can be costly.

Examples:

Just 10% increase in flow from worn nozzles represent a loss of \$2,000 to \$10,000 on a twice-sprayed 1,000 acre farm (based on \$10-\$50/acre chemical cost).

or

A 10% increase in flow rate would cost as much as €15/ha in on the average high yielding wheat crop, a loss of over €6,000 on a 400 hectare farm.

The good news is, monitoring and maintaining nozzle performance is one of the easiest ways to help keep a sprayer operating accurately and efficiently.

1. As a rule, replace nozzles worn (10% or more) or damaged at the beginning of each spraying season.
2. Only use the nozzle type that is recommended for your particular spraying application.
3. Calibrate your sprayer regularly to compensate for normal nozzle wear.
4. Monitor spray performance to catch worn, damaged, or plugged nozzles.

Hypro spray nozzles are precision-engineered components that should be regularly maintained to ensure that they give trouble-free service. To clear blocked nozzles, soak in water and clean with a brush and airline. For stubborn deposits, soak in warm water and detergent, agitating occasionally. Never blow through a nozzle or poke with wires or pins – damage to the orifice will alter flow rate, spray angle, and spray distribution.

FACTORS AFFECTING SPRAY NOZZLE PERFORMANCE

The information in the chart below applies to most spray applications. However, because there are so many different types and sizes of spray nozzles, the effects may vary in a specific application. Hypro is glad to assist you with any specific application questions.

Increase In	Operating Pressure	Specific Gravity	Viscosity	Fluid Temperature	Surface Tension
Capacity (Flow Rate)	Increases	Decreases	•	••	No Effect
Spray Angle	Increases then Decreases	Negligible	Decreases	Increases	Decreases
Droplet Size	Decreases	Negligible	Increases	Decreases	Increases
Pattern Quality	Improves	Negligible	Deteriorates	Improves	Negligible
Wear	Increases	Negligible	Decreases	Increases	--
Impact	Increases	Decreases	Decreases	Increases	Negligible
Velocity	Increases	Decreases	Decreases	Increases	Negligible

• Full cone and hollow cone increases, flat fan spray decreases

•• Depends on fluid being sprayed and spray nozzle used

ACCESSORIES

PROSTOP-E AND FENCE ROW CONTROL	PAGE 214
EXPRESS BOOM ASSEMBLY	PAGE 216
DUO REACT	PAGE 218
PROFLO NOZZLE BODIES AND ACCESSORIES	PAGE 219
PROCAP™ TANK LIDS AND TANK ACCESSORIES	PAGE 227
CLEANLOAD™ CHEMICAL EDUCTOR.....	PAGE 232
LINE STRAINERS	PAGE 235
SPRAY GUNS	PAGE 237
FLOWMETERS	PAGE 242
SPRAYER CONTROL VALVES	PAGE 243
BALL VALVES.....	PAGE 247
GAUGES	PAGE 248
UNIVERSAL FLANGE CLAMPS, GASKETS AND FITTINGS	PAGE 251
FITTINGS, CABLE TIES, HOSE CLAMPS & SEALANT.....	PAGE 253

PROSTOP-E AND CANNODE

High Performance Individual Nozzle Control



3305-0011

CN32-0001

- ◆ Control spray activation directly on Hypro ProFlo nozzle bodies
- ◆ Instantaneous on-off control with 12 volt actuation eliminates misapplication and waste
- ◆ Eliminates the need for centralized valve banks allowing on/off control at the nozzle body for individual or small section control
- ◆ Two actuation mode options:
 - Simple, 3-wire, 12 volt on/off actuation
 - Operate as an individually addressed valve on a CAN bus/ISO bus system
- ◆ Innovative locking collar mechanism allows for easy adjustments to valve orientation on the nozzle body
- ◆ The CanNode provides a CAN bus interface for up to 32 valves

PROSTOP-E VALVE AND NOZZLE BODIES

Part Number	Description
PK-4223N-B323VPSE*	3 way nozzle body, 3/4" clamp, with ProStop-E
PK-4223N-B324VPSE*	3 way nozzle body, 1" clamp, with ProStop-E
PK-4223N-B324VLPSE*	3 way nozzle body, 1" clamp, with left side mount ProStop-E
PK-4223N-B523VPSE*	5 way nozzle body, 3/4" clamp, with ProStop-E
PK-4223N-B524VPSE*	5 way nozzle body, 1" clamp, with ProStop-E
PK-4223N-B524VLPSE*	5 way nozzle body, 1" clamp, with left side mount ProStop-E
PK-4223N-B527PSE*	5 way nozzle body, 20 mm clamp, with ProStop-E
PK-4223N-B528PSE*	5 way nozzle body, 25 mm clamp, with Prostop-E
3305-0011	ProStop-E valve only - for user supplied Hypro nozzle body



* For bulk packaged remove the PK- from the part number or contact factory
 ProStop-E Valve easily adapts directly to ProFlo single drop, 3-way/5-way and push-to-connect nozzle bodies in place of the traditional check valve.
 Valve and nozzle body must be ordered separately, for configurations not listed above.

CAN BUS INTERFACE MODULE



Part Number	Number of Segments	Number of Valves
CN32-0001	2	32

CAN bus/ISOBUS node is required for CAN bus communication. The node auto addresses each valve on the segment up to 16 valves per segment.

PROSTOP-E CORDSETS

Part Number	Description	Connector Styles	Length
2520-0239	635 mm ultra lock	right angle A code - right angle D code	25"
2520-0240	635 mm threaded right angle connectors - right side	right angle A code - right angle D code	25"
2520-0241	635 mm threaded right angle connectors - left side	right angle A code - right angle D code	25"
2520-0242	1 meter threaded right angle connectors	right angle A code - right angle D code	1 meter
2520-0243	2 meter threaded right angle connectors	right angle A code - right angle D code	2 meter
2520-0244	3 meter threaded right angle connectors	right angle A code - right angle D code	3 meter
2520-0245	7 meter threaded straight extension	straight male A code - straight female A code	7 meter
2520-0259	12.5 meter right angle connectors	right angle A code - right angle D code	12.5 meter

Black-in; Grey-out, Other custom length cord sets available upon request.



2520-0239



2520-0240
Right of CanNode



2520-0241
Left of CanNode



2300-0067



FEATURES & BENEFITS OF CONTROL BOX:

- ◆ Control one or two Hypro ProStop-E valves with easy on-off switch
- ◆ Allows for retrofit of sprayers for adding fence/end row control
- ◆ Simple M12 wiring to battery and valves for plug and play
- ◆ Easy to mount bracket provided
- ◆ Cable options for up to 120" boom length
- ◆ LED light indicator on each switch

Control Box	Description	Connection	Amp Rating
2850-0027	End Row Switch Box	Male 3-pin for Battery, Female 4-pin for Control	4A

Cable Part Numbers:	Description	Connection	Amp Rating
2520-0218	7M (23 ft) backbone cable	Threaded, M12 A-code by M12 A-Code	4A
2520-0217	Single end row control 27M (88.5 ft) cable	Threaded, Male 4-pin M12 by female 4-pin M12	4A
2520-0219	Y-cable with two 20M (65 ft) segments	Threaded, Male 4-pin by two Female 3-pin M12 A-Code	4A
2520-0216	7M (23 ft) battery cable	Threaded, Female 3-pin A-Code by flying leads	4A

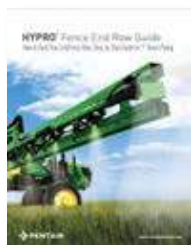
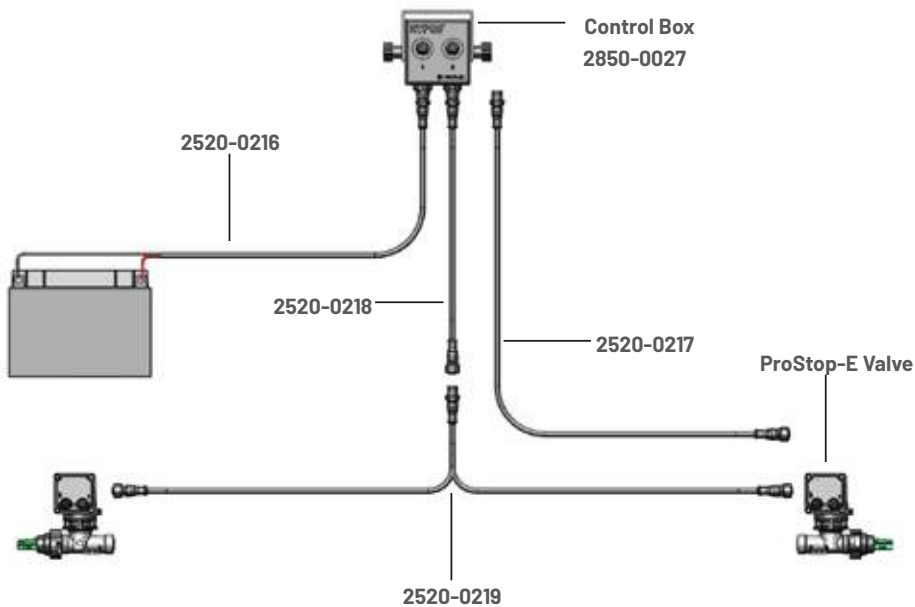

STEP-BY-STEP GUIDE:

See Hypro's Step-by-Step Guide to build your End/Fence Row Kit.
www.hyprospraytips.com/stepbystep

EXPRESS BOOM ASSEMBLY

Modular Boom Sections

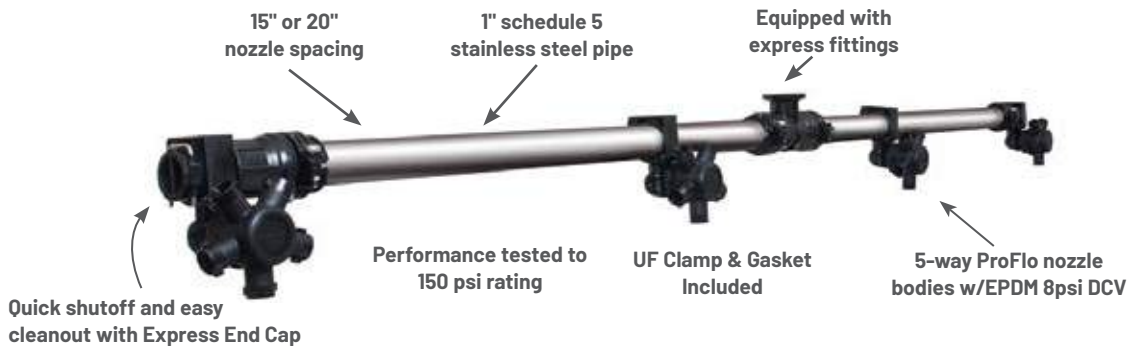

EXPRESS END CAP BENEFITS

- ◆ Eliminates trapped air from the boom by allowing air to escape through the nozzle body, reducing nozzle turn-off time by 85%
- ◆ Eliminates “dead-ends” of pipe where chemical residue can build-up
- ◆ Cleanout port for easy boom flushing
- ◆ Creates a cleaner looking plumbing system by eliminating the need for an extra fitting at the end of the boom

EXPRESS BOOM ASSEMBLY BENEFITS

- ◆ Convert 20” nozzle spacing to 15” or 15” to 20”
- ◆ Easily convert your boom from polypropylene to stainless steel
- ◆ Greatly reduces assembly time
- ◆ Tested as a complete assembly to eliminate any potential assembly defects
- ◆ Single and bulk pack options that allow for standard shipping methods (i.e. FedEx®, UPS®, etc.)
- ◆ Improve sprayer performance with Express fittings and optimized design

1	<p>Complete boom assembly configuration sheet (visit www.hypropumps.com/express for configuration worksheet). Note sprayer model, number of sections, desired spacing's and boom length.</p> <p>Walk boom from left breakaway to right* (Note all feeds, section controls, breakaways, etc.). If you run into configurations larger than 6 nozzle bodies with 15” spacing or 5 nozzle bodies with 20” spacing, break section into two to fit express boom system. If you have any questions, please contact your local Hypro representative or Hypro technical team.</p>
2	<p>Review 'Quote' tab on configuration worksheet. Re-evaluate boom configuration to insure proper assembly. Look specifically at where the tee fitting will be plumbed to the feed line. If there are interference issues with the boom structure look at alternative horizontal fittings that allow feed lines to mate up to express boom.</p>
3	<p>Print 'Quote' sheet and submit to your local Hypro sales representative or email to hypro.sales@pentair.com for pricing and availability.</p>

Hypro Quote Review: Hypro will review boom assembly quote sheet submitted. If local dealer is not listed on sheet, Hypro will contact you for final ordering procedures.

EXAMPLE CONFIGURATION W/15” SPACING:

Section	Section 1		Section 2	Section 3	Section 4	Section 5	
Sequence	A	B	C	D	E	F	G
Boom Pipe Part Number	2410-0055	2410-0068	2410-0075	2410-0068	2410-0075	2410-0068	2410-0060
Configuration	2X3	4X4	5X5	4X4	5X5	4X4	3X2

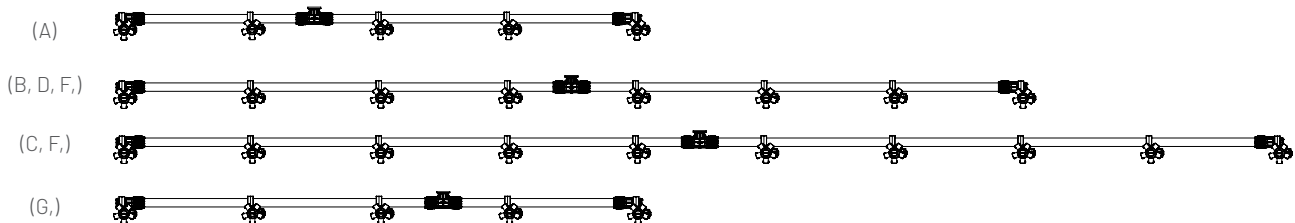

EXPRESS BOOM ASSEMBLY

Modular Boom Sections

Hypro's Express Boom Assembly allows you to **CUSTOMIZE** each boom section by choosing the quantity of nozzle bodies either left or right of the tee for each section. Express Boom Assembly has the **FLEXIBILITY** to meet any boom design. These single section **CUSTOM** configurations can range from one nozzle body on the left and/or right branch, to six (15" spacing's) nozzle bodies on each branch. Review the chart below for all configuration options.

	Choose Left Branch	Tee	Choose Right Branch	
1				1
2				2
3				3
4				4
5				5
6*				6*

* Only available in 15" spacings.

PRODUCT CONFIGURATIONS

Configuration	15" Spacing Part Number	20" Spacing Part Number
1X1	2410-0047	2410-0021
1X2	2410-0048	2410-0022
1X3	2410-0049	2410-0023
1X4	2410-0050	2410-0024
1X5	2410-0051	2410-0025
1X6	2410-0052	-
2X1	2410-0053	2410-0026
2X2	2410-0054	2410-0027
2X3	2410-0055	2410-0028
2X4	2410-0056	2410-0029
2X5	2410-0057	2410-0030
2X6	2410-0058	-
3X1	2410-0059	2410-0031
3X2	2410-0060	2410-0032
3X3	2410-0061	2410-0033
3X4	2410-0062	2410-0034
3X5	2410-0063	2410-0035
3X6	2410-0064	-
4X1	2410-0065	2410-0036
4X2	2410-0066	2410-0037
4X3	2410-0067	2410-0038
4X4	2410-0068	2410-0039
4X5	2410-0069	2410-0040
4X6	2410-0070	-

Configuration	15" Spacing Part Number	20" Spacing Part Number
5X1	2410-0071	2410-0041
5X2	2410-0072	2410-0042
5X3	2410-0073	2410-0043
5X4	2410-0074	2410-0044
5X5	2410-0075	2410-0045
5X6	2410-0076	-
6X1	2410-0077	-
6X2	2410-0078	-
6X3	2410-0079	-
6X4	2410-0080	-
6X5	2410-0081	-
6X6	2410-0082	-
1XHB	2410-0086	2410-0086
2XHB	2410-0087	2410-0091
3XHB	2410-0088	2410-0092
4XHB	2410-0097	2410-0093
5XHB	2410-0098	2410-0094
HBX1	2410-0083	2410-0083
HBX2	2410-0084	2410-0089
HBX3	2410-0085	2410-0090
HBX4	2410-0099	2410-0095
HBX5	2410-0100	2410-0096

DUO REACT NOZZLE BODIES

Compact and Economical Twin Valve Nozzle Body

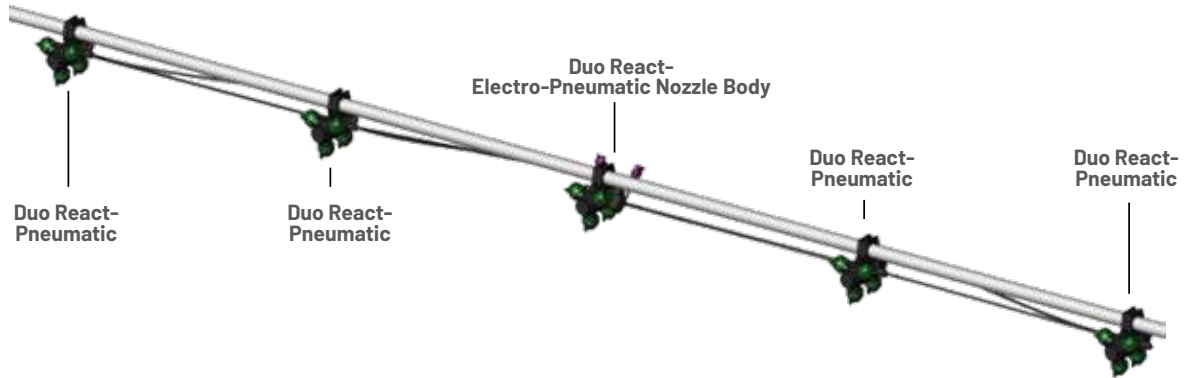

- ◆ A single and 4-way nozzle body incorporated into one compact unit
 - Eliminates the need for twin lines or “back to back” configurations
 - Simple operation, twin valves allow either or both nozzles to spray
- ◆ Allows the operator to select different nozzle combinations from the cab with a controller
- ◆ Compact design allows for easy integration into many boom designs
- ◆ Pneumatic only or electro-pneumatic actuated valve options
 - Electro-pneumatic body can be used in place of a section control valve to control up to 7 pneumatic Duo React nozzle bodies
- ◆ Available with hinged clamps 1/2”, 3/4”, 1”, 20mm and 25m



DUO REACT ELECTRO-PNEUMATIC TWIN VALVE NOZZLE BODIES FOR WET BOOM

Seal Options/ Housing Reference	(to clamp on) Pipe Size				
	1/2"	3/4"	1"	20 mm	25 mm
Viton®/Green	4214-2502V	4214-2503V	4214-2504V	4214-2507V	4214-2508V



DUO REACT PNEUMATIC TWIN VALVE NOZZLE BODIES FOR WET BOOM

Seal Options/ Housing Reference	(to clamp on) Pipe Size				
	1/2"	3/4"	1"	20 mm	25 mm
Viton®/Green	4214-1502V	4214-1503V	4214-1504V	4214-1507V	4214-1508V

DUO REACT SPARE PARTS AND TOOL

Part Number	Description
3430-0840V	O-ring, piston and filter sub-assembly kit
3021-0006	Cap removal service wrench

PROFLO NOZZLE BODIES

Nozzle Bodies with the Highest Flow Rates in the Industry



BENEFITS:

- ◆ Designed to deliver the highest flow rates across the spraying pressure range
 - Unique DCV (diaphragm check valve) design reduces restrictions in the flow path, enabling 2.6 gpm (9.8 lpm) with a 5 psi (0.34 bar) pressure drop through the nozzle
 - Supports faster field speeds with the same coverage and supports direct fertilizer application through the nozzle body DCV flow path
- ◆ Turret-indexing design provides improved consistency and reliability throughout the life of the nozzle body - eliminating free spinning and seizing problems seen on competitive nozzle bodies
- ◆ Bayonet style attachment allows for automatic spray alignment using flat fan spray nozzles
- ◆ Compact design makes mounting easier with less potential interference with the spray boom structure
- ◆ ProFlo nozzle bodies come standard with an 8 psi (.55 bar) diaphragm check valve. 4 psi (.27 bar), 12 psi (.82 bar), 20 psi (1.37 bar), and 25 psi (1.72 bar) checks are available as options
- ◆ Maximum working pressures for all nozzle bodies

FEATURES:

- ◆ Three turret styles for an easy change of spray nozzles: single, 3-way, and 5-way
- ◆ Provides lowest pressure drop at any given flow in the industry
- ◆ 2.6 gpm (9.84 LPM) with a 5 psi (.345 BAR) pressure drop
- ◆ Available in wet or dry boom versions
- ◆ Positive shutoff between each spray position
- ◆ Custom logos available upon request (minimum quantities apply)

PROFLO NOZZLE BODY PERFORMANCE CURVE

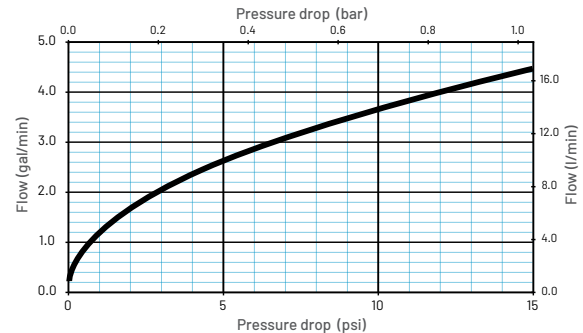

3 AND 5-WAY NOZZLE BODIES FOR WET BOOM (NO TAB FOR BOOM CLAMP)

Seal Option/ Housing Reference	Turret Options	(to clamp on) Pipe Size					
		1/2"	3/4"	1"	1" (Left Handed DCV)	20mm	25mm
EPDM/Red	3	4223N-B322	4223N-B323	4223N-B324	BG-4223N-B324L	4223N-B327	4223N-B328
	5	4223N-B522	4223N-B523	4223N-B524	BG-4223N-B524L	4223N-B527	4223N-B528
Viton®/Green	3	4223N-B322V	4223N-B323V	4223N-B324V	BG-4223N-B324VL	4223N-B327V	4223N-B328V
	5	4223N-B522V	4223N-B523V	4223N-B524V	BG-4223N-B524VL	4223N-B527V	4223N-B528V

Sold in Quantities of 100; Sold as single units through HYPRO-EU only (Cambridge,UK)

For Individual Bags, Add Suffix -00 (i.e.: 4223N-B322-00)

ProStop Valve in place of DCV - Add suffix "PS" (ie. 4223N-B322PS)

Left hand DCV versions are sold as individual units in a bag.



TRIPLE NOZZLE BODIES FOR WET BOOM

Seal Option / Housing Reference	Part Number	Description
EPDM/Red	4222N-B322	1/2" split clamp
	4222N-B323	3/4" split clamp
	4222N-B324	1" split clamp

SINGLE DROP NOZZLE BODY FOR WET BOOM

Seal Option/ Housing Reference	(to clamp on) Pipe Size				
	1/2"	3/4"	1"	20mm	25mm
EPDM/Red	4221N-B122	4221N-B123	4221N-B124	4221N-B127	4221N-B128
Viton®/Green	4221N-B122V	4221N-B123V	4221N-B124V	4221N-B127V	4221N-B128V

Acid resistant polypropylene available with 1" clamp and EPDM Seal. part number: 402265P

1/4" FNPT Outlet- Substitute B with F (i.e.: 4221N-F122)

Sold in Quantities of 100; Sold as single units through HYPRO-EU only (Cambridge,UK)

For Individual Bags, Add Suffix -00 (i.e.: 4221N-B122-00)

ProStop Valve in place of DCV - Add suffix "PS" (ie. 4221N-B122PS)

PROFLO NOZZLE BODIES



3 & 5-WAY NOZZLE BODIES WITH TAB FOR BOOM CLAMP

Seal Option/ Housing Reference	Turret Options	(to clamp on) Pipe Size				
		1/2"	3/4"	1"	20mm	25mm
EPDM/Red	3	4243N-B322	4243N-B323	4243N-B324	4243N-B327	4243N-B328
	5	4243N-B522	4243N-B523	4243N-B524	4243N-B527	4243N-B528
Viton®/Green	3	4243N-B322V	4243N-B323V	4243N-B324V	4243N-B327V	4243N-B328V
	5	4243N-B522V	4243N-B523V	4243N-B524V	4243N-B527V	4243N-B528V

Sold in Quantities of 100; Sold as single units through HYPRO-EU only (Cambridge,UK)

For Individual Bags, Add Suffix -00 (i.e.: 4243N-B322-00).

ProStop Valve in place of DCV - Add suffix "PS" (ie. 4243N-B322PS)



3 & 5-WAY NOZZLE BODIES WITH TAB FOR BOOM CLAMP AND HOSE BARB FOR DRY BOOM

Seal Option/ Housing Reference	Turret Options	3/4" (19 mm)	3/4" (19 mm)	1" (25 mm)	1" (25 mm)
		Single Ended HB	Double Ended HB	Single Ended HB	Double Ended HB
EPDM/Red	3	4263N-B323S	4263N-B323D	4263N-B324S	4263N-B324D
	5	4263N-B523S	4263N-B523D	4263N-B524S	4263N-B524D
Viton®/Green	3	4263N-B323SV	4263N-B323DV	4263N-B324SV	4263N-B324DV
	5	4263N-B523SV	4263N-B523DV	4263N-B524SV	4263N-B524DV

Sold in Quantities of 100.

For Individual Bags, Add Suffix -00 (i.e.: 4263N-B323S-00).

DRY BOOM ADAPTERS FOR WET BOOM NOZZLE BODIES

Part Number	Type	Clamp Size	Hose Barb	
			US Units	Metric Units
4200-0111N	Single	1/2" Pipe	1/2"	13 mm
4200-0112N	Single	3/4" Pipe	3/4"	19 mm
4200-0113N	Single	3/4" Pipe	1"	25 mm
4200-0114N	Single	1" Pipe	3/4"	19 mm
4200-0115N	Single	1" Pipe	1"	25 mm
4200-0211N	Double	1/2" Pipe	1/2"	13 mm
4200-0212N	Double	3/4" Pipe	3/4"	19 mm
4200-0213N	Double	3/4" Pipe	1"	25 mm
4200-0214N	Double	1" Pipe	3/4"	19 mm
4200-0215N	Double	1" Pipe	1"	25 mm



HOSE BARB TRIPLE NOZZLE BODIES-WITH DCV

Seal Options/ Housing Reference	Single hose barb P/N	Double hose barb P/N	Hose ID	
			US Units	Metric Units
EPDM/Red	4242N-B322S	4242N-B322D	1/2"	13 mm
	4242N-B323S	4242N-B323D	3/4"	19 mm

4242N-B300-Provides 1/4" MNPT Inlet



HOSE BARB DRY BOOM NOZZLE BODIES-WITH DCV

Seal Options/ Housing Reference	Single hose barb P/N	Double hose barb P/N	Triple hose barb P/N	Hose ID	
				US Units	Metric Units
EPDM/Red	4241N-B121S	4241N-B121D	4241N-B121T	3/8"	10 mm
	4241N-B122S	4241N-B122D	4241N-B122T	1/2"	13 mm
	4241N-B123S	4241N-B123D	4241N-B123T	3/4"	19 mm

Add Prefix "BG-" for 1 part per retail bag.





HOSE BARB DRY BOOM NOZZLE BODIES-WITH TOP-MOUNTED DCV

Seal Options/ Housing Reference	Single hose barb P/N	Double hose barb P/N	Hose ID	
			US Units	Metric Units
EPDM/Red	4240N-B121S	4240N-B121D	3/8"	10 mm
	4240N-B122S	4240N-B122D	1/2"	13 mm
	4240N-B123S	4240N-B123D	3/4"	19 mm

Add Prefix "BG-" for 1 part per retail bag.



SINGLE NOZZLE BODIES WITH DCV

Seal Options/ Housing Reference	1/4" MNPT x 1/4" FNPT			1/4" MNPT x Bayonet		1 1/16" UNF x Bayonet	3/8" (10 mm) HB x Bayonet
	4 PSI (.28 BAR)	8 PSI (.55 BAR)	25 PSI (1.72 BAR)	4 PSI (.28 BAR)	8 PSI (.55 BAR)	8 PSI (.55 BAR)	8 PSI (.55 BAR)
EPDM/Red	4240N-F110	4240N-F120	4240N-F150	4240N-B010	4240N-B020	4241N-B120U	QT14-1-NDC
Viton®/Green	4240N-F110V	4240N-F120V	4240N-F150V	4240N-B010V	4240N-B020V	-	-

PUSH-TO-CONNECT NOZZLE BODIES

Push-to-Connect (PTC) Nozzle Body Part Numbers					
Type	DCV	4 PSI (.28 BAR)		8 PSI (.55 BAR)	
	Size	25 Std. Pack	1 Per Bag	25 Std. Pack	1 Per Bag
PTC to Bayonet	1/4"	4247N-B119	BG-4247N-B119	4247N-B129	BG-4247N-B129
	3/8"	4247N-B111	BG-4247N-B111	4247N-B121	BG-4247N-B121
PTC to PTC	1/4"	4247N-C119	BG-4247N-C119	4247N-C129	BG-4247N-C129
	3/8"	4247N-C111	BG-4247N-C111	4247N-C121	BG-4247N-C121

To order without a DCV remove 9th digit and replace with an "X". Example: 4247N-B1X9



HOSE BARB DRY BOOM NOZZLE BODIES-NO DCV

Single hose barb P/N	Double hose barb P/N	Triple hose barb P/N	Hose ID	
			US Units	Metric Units
4231N-B101S	4231N-B101D	4231N-B101T	3/8"	10 mm
4231N-B102S	4231N-B102D	4231N-B102T	1/2"	13 mm
4231N-B103S	4231N-B103D	4231N-B103T	3/4"	19 mm

WET BOOM SINGLE NOZZLE BODIES-NO DCV

Single hose barb P/N	Hose ID
4201N-B102	1/2" clamp
4201N-B103	3/4" clamp
4201N-B104	1" clamp

Add Suffix "-00" for 1 part per retail bag.



REPLACEMENT NOZZLE BODY STEM SEALS

Part Number	Description/Material
1723-0142	10 mm Wet Boom Stem Seal-EPDM
1721-0220	10 mm Wet Boom Stem Seal-Viton

SCREW, NUT & STEM O-RING KIT

Part Number	Description/Material
3430-0755	Contains replacement screw, nut and stem o-ring/EPDM
3430-0755V	Contains replacement screw, nut and stem o-ring/Viton



REPLACEMENT SEAL/O-RING KIT PROFLO BODY

Part Number	Description/Material
3430-0754	Contains all internal seals/EPDM
3430-0754V	Contains all internal seals/Viton®

EXPRESS NOZZLE BODY END CAPS AND FITTINGS

Terminates the pipe at the last nozzle body, eliminating six inches of dead-ends from each pipe end for better boom hygiene.

Creates a cleaner looking plumbing system by eliminating the need for an extra fitting at the end of the boom

Optional cleanout port for easy boom flushing

Eliminates trapped air from the boom by allowing air to escape through the nozzle body, reducing nozzle turn-off time by 85%

EXPRESS NOZZLE BODY END CAP



Part Number (Carton Qty: 100)	Part Number (1 per Bag)	Description	Nozzle Body Type
7433-3316	BG-7433-3316	1" Express™ fitting with nozzle body end cap allows trapped air to escape through the nozzle body and includes removable plug for boom cleanout.	10 mm Stem
7433-3314	BG-7433-3314		17 mm Stem

7433-2600 repair kit 10mm stem and 7433-2514 repair kit for 17mm stem Kit includes: plug, O-ring and clip.

EXPRESS NOZZLE BODY END CAP RETROFIT KIT



Part Number	Description	Cutting Jig Material	Nozzle Body Type
3410-0044	Kit includes machinist-quality drill bit, drilling and cutting jig for 1" pipe, Emery cloth, and instructions to retrofit conventional wet boom spray pipe for Express nozzle body end caps.	Aluminum	10 mm Stem
3410-0043		Aluminum	17 mm Stem



WE RECOMMEND USING A RIDGID PIPE CUTTER. AVAILABLE AT ANY HARDWARE STORE.

EXPRESS WET BOOM FITTINGS

Part Number (Carton Qty: 50)	Part Number (1 per Bag)	Description	Ref #
7433-2502	BG-7433-2502	Express Fitting X 1" Universal Flange Straight	1
7433-2503	BG-7433-2503	2 Express Fitting X 1" Universal Flange Tee (Vertical)	2
7433-2525	BG-7433-2525	2 Express Fitting X 1" Universal Flange Tee (10° offset from vertical)	
7433-2535	BG-7433-2535	2 Express Fitting X 1" Universal Flange Tee (45° offset from vertical)	
7433-2545	BG-7433-2545	2 Express Fitting X 1" Universal Flange Tee (30° offset from vertical)	
7433-2515	BG-7433-2515	2 Express Fitting X 1" Universal Flange Tee (Horizontal)	3
7433-2608	BG-7433-2608	Express Fitting X 1" Hose Barb Straight	4
7433-2610	BG-7433-2610	Express Fitting X 1" Hose Barb Elbow Vertical	5
7433-2601	BG-7433-2601	Express Fitting X 1" Hose Barb Elbow Horizontal	6
7433-2613	BG-7433-2613	Express Fitting X 1" Male Cam Lock Straight	7
-	UFG0100E-A	1" EPDM Universal Flange Gasket provides high quality sealing for flanged fittings	8
2910-0026	BG-2910-0026	Express Clamps & Hardware Kit	9
3430-0790	BG-3430-0790	Express Clamps & Hardware Kit with Pipe O-rings	10

For high quality sealing to flange fitting, use Hypro's Universal Flange Gasket.



NOZZLE BODY SHUT-OFF CONTROLS



PROSTOP-E (SEE PAGE 214 FOR MORE DETAILS ON PROSTOP-E)

- ◆ Control spray activation directly on Hypro ProFlo nozzle bodies
- ◆ Instantaneous on-off control with 12 volt actuation eliminates misapplication and waste
- ◆ Eliminates the need for centralized valve banks allowing on/off control at the nozzle body for individual or small section control
- ◆ Two actuation mode options:
 - Simple, 3-wire, 12 volt on/off actuation
 - Operate as an individually addressed valve on a CAN bus/ISO bus system
- ◆ Innovative locking collar mechanism allows for easy adjustments to valve orientation on the nozzle body
- ◆ The CanNode provides a CAN bus interface for up to 32 valves

PROSTOP-E - 12 VOLT ACTUATED ON/OFF NOZZLE CONTROL

Part Number	Description
3305-0011	ProStop-E valve assembly fits all Hypro ProFlow nozzle bodies in place of the check valve

CAN BUS INTERFACE MODULE

Part Number	Number of Segments	Number of Valves
CN32-0001	2	32

PROSTOP

- ◆ Rapidly and accurately start and stop nozzle flow
- ◆ Compatible with convenient push-connect air fittings and tube
- ◆ Connect one air circuit per boom section
- ◆ Air pressure activates spray, spring closure provides positive shut-off for transport and storage
- ◆ Durable and chemically-resistant polypropylene, PVDF, and EPDM components
- ◆ A 40 psi (3 bar) pneumatic signal controls a maximum spray pressure of 150 psi (10 bar)
- ◆ Operational temperature range: 41°F to 113°F (5°C to 45°C)
- ◆ ProStop can be specified in place of the diaphragm check valve (DCV) on select ProFlo nozzle bodies. Add suffix "PS" to nozzle body part number shown.



PROSTOP-AIR-ACTUATED ON/OFF NOZZLE CONTROL CONTROL

Part Number	Description
PS3/4F-PN	ProStop valve assembly
65VBS0182-17	O Ring Viton®
7002738	Prostop™ valve banjo 6mm
43Q2741	Prostop™ replacement piston sub-assembly
3010-WR0008	Chuck wrench (8mm sq capacity)
3010-EX0004	Screw extractor no. 4

REPLACEMENT CHECK VALVE (DCV) INCLUDES FLYNUT, HOUSING AND SPRING

Housing Reference	Spring Pressure Plunger Reference Color				
	4 PSI (.28 BAR) Orange	8 PSI (.55 BAR) Black	12 PSI (.83 BAR) Yellow	20 PSI (1.38 BAR) Gray	25 PSI (1.72 BAR) Blue
Red	4200-0010	4200-0020	4200-0030	4200-0040	4200-0050
Green	4200-0010V	4200-0020V	4200-0030V	4200-0040V	4200-0050V

Red housing indicates for use with EPDM Seals. Green housing indicates for use with Viton Seals.
 Note: Diaphragms are sold separately.

REPLACEMENT DIAPHRAGM SEAL OPTIONS FOR CHECK VALVES

Option	Part Number	Color Reference
EPDM	4200-0004E	Black
Viton®	4200-0004V	Green

POSITIVE SHUT-OFF

Part Number	Description
4200-0025	8 PSI (.55 bar) DCV with positive shut-off



NOZZLE BODY ACCESSORIES



WET BOOM BLANKS

Part Number	Material	Description
400059	Nylon	3/4" Pipe
400069	Nylon	1" Pipe
400059P*	Polypropylene	3/4" Pipe
400069P*	Polypropylene	1" Pipe

*Comes standard with Viton® o-ring.



SERIES 404 SWIVEL AND THREADED-SWIVEL NOZZLE BODIES

Part Number	Description
4200N-0020	Single Swivel 1/4" FNPT X Quick Attach
4200N-0021	Double Swivel 1/4" FNPT X 2 Quick Attach
4200N-0023	Single 1/4" FNPT X 11/16" - 16UN(M)
4200N-0024	Double 1/4" FNPT X 11/16" - 16UN(M)
4200N-0025	Red Retaining Cap 11/16" - 16UN(F)
4200N-0026	Black Retaining Cap 11/16" - 16UN(F)

HOSE DROPS



Part Number	Length		Description Outlet, Inlet
	US Units	Metric Units	
430001	15"	38.1 cm	1/4" NPT, 11/16" - 16UN(M)
430002	24"	60.9 cm	1/4" NPT, 11/16" - 16UN(M)
430201	15"	38.1 cm	1/4" NPT, Quick Attach Fitting
430202	24"	60.9 cm	1/4" NPT, Quick Attach Fitting
430201V	15"	38.1 cm	1/4" NPT, Quick Attach Fitting with Viton
430202V	24"	60.9 cm	1/4" NPT, Quick Attach Fitting with Viton



BALL NOZZLE HOLDERS

Part Number	Ball Thread	Attach Method
40867BN	1/4" FNPT	Handlock Clamp 1" pipe
4081BON	1/4" FNPT	Threaded 1/4" MNPT

NOZZLE BODY ACCESSORIES



11/16" UN NOZZLE BODIES

Reference Number	Standard Pack	Description		Nylon Part Number	Poly Part Number
		US Units			
1	25	11/16" - 16UN(M) X 1/4" (6 mm) HB Elbows		NTL14	3NTL14
1	25	11/16" - 16UN(M) X 3/8" (10 mm) HB Elbows		NTL38	3NTL38
1	25	11/16" - 16UN(M) X 1/2" (13 mm) HB Elbows		NTL12	3NTL12
1	25	11/16" - 16UN(M) X 5/8" (16 mm) HB Elbows		NTL58	3NTL58
1	25	11/16" - 16UN(M) X 3/4" (19 mm) HB Elbows		NTL34	3NTL34
2	25	11/16" - 16UN(M) X 3/8" (10 mm) HB Tees		NTT38	3NTT38
2	25	11/16" - 16UN(M) X 1/2" (13 mm) HB Tees		NTT12	3NTT12
2	25	11/16" - 16UN(M) X 5/8" (16 mm) HB Tees		NTT58	3NTT58
2	25	11/16" - 16UN(M) X 3/4" (19 mm) HB Tees		NTT34	3NTT34
3	25	11/16" - 16UN(M) X 3/8" (10 mm) HB Crosses		T38C	3T38C
3	25	11/16" - 16UN(M) X 1/2" (13 mm) HB Crosses		T12C	3T12C
3	25	11/16" - 16UN(M) X 3/4" (19 mm) HB Crosses		T34C	3T34C
4	25	11/16" - 16UN(M) X 3/8" (10 mm) HB Nozzle Shanks Straight		38D	338D
4	25	11/16" - 16UN(M) X 1/2" (13 mm) HB Nozzle Shanks Straight		3812D	33812D
5	25	11/16" - 16UN(F) X 1/4" (6 mm) FNPT Female Spray Nozzle Adapter		NF1614	3NF1614
6	25	11/16" - 16UN(M) X 1/4" (6 mm) MNPT Nipples		NB1614	3NB1614
6	25	11/16" - 16UN(M) X 1/2" (16 mm) MNPT Nipples		NB1612	3NB1612
7	25	3/8" FNPT X 11/16" - 16UN(M) Ball Check Valve for nozzle fittings (10 PSI/ .69 BAR)		NBC10	-----

Includes B12/3B12 nut.
 Add Prefix "BG-" for 1 part per retail bag.
 Add Prefix "5BG-" for 5 parts per retail bag.

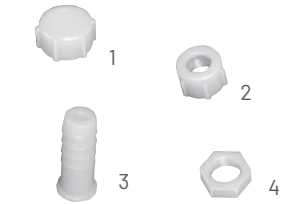

11/16" UN NOZZLE BODY CAP AND NUT

Reference Number	Standard Pack	Description	Nylon Part Number	Poly Part Number
1	25	11/16" - 16UN(F) Nozzle blank cap	3942*	33942*
2	25	11/16" - 16UN(F) Nozzle cap for nozzle/barb	8027*	38027*
3	25	1/4" (6 mm) HB for 8027/38027 cap	K8414	3K8414
3	25	3/8" (10 mm) HB for 8027/38027 cap	K8438	3K8438
3	25	1/2" (13 mm) HB for 8027/38027 cap	K8412	3K8412
4	25	11/16" - 16UN jamb nut	B12*	3B12*

*Fits all nozzle fittings with 11/16" male straight thread.



1" BOOM CLAMP

Part Number	Standard Pack	Material	Description
2910-0037	25 sets	Polypropylene	1" Boom Clamp to hold 1" pipe on a boom structure

1/4" fasteners are not included.

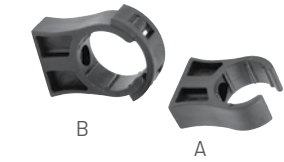

COBRA CLIP BOOM PIPE MOUNTS

Part Number	Ref.	Description
0113434307	A	3/4" or 25mm nominal boom pipe mount
0113434308	B	1" or 32mm nominal boom pipe mount w/ keep strap
01134343010	B	1-1/2" or 40mm nominal boom pipe mount w/ keep strap

BLACK POLYPROPYLENE BOOM PIPE (UNDRILLED) - SCHEDULE 80 - 20 FT SECTIONS



Part Number	Nominal Pipe Size	Pipe Length		Wall Thickness	Wall Tolerance	Outside Diameter		Max. Operating Pressure @ 73° F/22.8° C	
		US Units	Metric Units			US Units	Metric Units	PSI	BAR
8034-F-00PP	3/4"	20 ft	6.1 m	0.154	+0.020	1.050	26.7 mm	270	18.6
801-F-00PP	1"	20 ft	6.1 m	0.179	+0.021	1.315	33.4 mm	250	17.2
80112-F-00PP	1-1/2"	20 ft	6.1 m	0.220	+0.021	1.905	48.4 mm	200	13.8

NOZZLE BODY ACCESSORIES & FOAM MARKER



QUICK FITTING ADAPTERS

Reference #	Part #	Description	Packaging
-	4200-0015N	1/4" BSP x Quick Attach	None
1	4200-0016N	1/4" MNPT x Quick Attach	None
2	4200N-0017	45° Double Elbow w/Gasket	10/ Bag, Priced Individually
3	4200N-0018	90° Elbow x Quick Attach	10/ Bag, Priced Individually
4	4200-0019	1/4" FNPT x Quick Attach	None
5	9950-0024	Hardi* Adapter	10/ Bag, Priced Per Bag
6	9950-0027	Jacto** Adapter	10/ Bag, Priced Per Bag
7	CPV007	3/8" HB x 1/4" FNPT w/ Boom clamp	None
8	BG-400275N	1/4" FNPT x Quick Attach	1/Bag

* Hardi is a registered trademark of Hardi International A/S

** Jacto is a registered trademark of Jacto, Inc.

VARI-SPACING CLAMPS



Part Number	Material	Piping/Tubing O.D.
413003*	Steel	3/4" (26.7 mm) Round Pipe (1.050")
413004*	Steel	1" (33.5 mm) Round Pipe (1.315")
413005*	Steel	1-1/4" (42 mm) Round Pipe (1.660")
413013	Steel	3/4" (19 mm) Square Tubing
413014	Steel	1" (25 mm) Square Tubing
413015	Steel	1-1/4" (32 mm) Square Tubing
413016	Steel	1-1/2" (38 mm) Square Tubing

Add Prefix "BG-" for 1 part per retail bag

* By pipe, dimensions refer to I.D. (inner diameter).

PROFLO DRY BOOM CLAMPS WITH SLOT FOR EASY ASSEMBLY- BOXES OF 100



Part Number	Material	Piping/Tubing O.D.
1520-1075	zinc plated steel	3/4" (14 mm) square tubing
1520-1100	zinc plated steel	1" (25 mm) square tubing
1520-1125	zinc plated steel	1-1/4" (32 mm) square tubing
1520-1150	zinc plated steel	1-1/2" (38 mm) square tubing
1520-1075SS	304 stainless steel	3/4" (19 mm) square tubing
1520-1100SS	304 stainless steel	1" (25 mm) square tubing
1520-1125SS	304 stainless steel	1-1/4" (32 mm) square tubing
1520-1150SS	304 stainless steel	1-1/2" (38 mm) square tubing

Add Prefix "BG-" for 1 part per retail bag

STEEL BOOM CLAMPS FOR USE WITH 11/16" NOZZLE BODIES

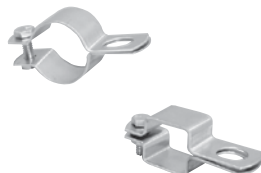

Part Number	Description
BC34R*	3/4" (26.7 mm) Round Pipe
BC100R*	1" (33.4 mm) Round Pipe
BC100	1" (25 mm) Square
BC114	1-1/4" (32 mm) Square

* Dimensions refer to I.D. (inner diameter).

FOAM MARKER

Part Number	Part Number	Description
520005	52520005	Foam Marker System

Available for order through HYPRO -EU only (Cambridge, UK)



- ◆ Save money and increase efficiency by avoiding costly misses and overlaps while spraying
- ◆ Covers up to 500 acres (200 hectares) with only a 5-gallon (19 litre) tank
- ◆ No pre-mixing required - foam is made in the drop assembly at the end of the boom
- ◆ Fits any crop sprayer, turf sprayer or seeding machine (extra hose required for booms longer than 60 feet (18 m)- part # 520000-751)
- ◆ Electro-pneumatically operated, requiring a 12-volt DC 6 Amp power supply
- ◆ 108' (33 m) dual liquid/air hose with thermoformed polystyrene covering for UV protection

PROCAP TANK LIDS



ProCap tank lids feature a rugged design that is easy to use and provides a safe and secure cover for a variety of tanks. All lids are made from sturdy polypropylene material to withstand harsh chemicals and ultraviolet rays.

INCREASED LABYRINTH BREATHER CAPACITY SUPPORTS HIGHER TANK FILLING RATES

LABYRINTH BREATHER

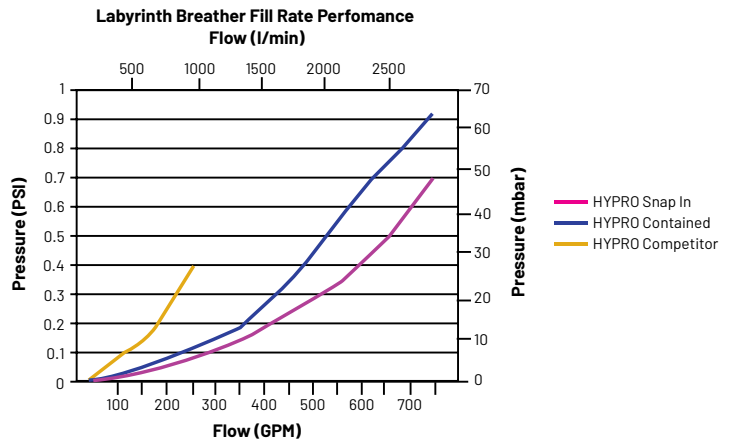
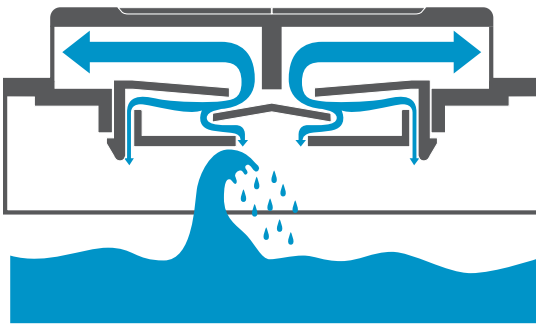

As depicted in the graph above, the Hypro Labyrinth Breather consistently performs at a higher fill rate and lower pressure than the typical competitor.



- ◆ Easily replaces an old or lost lid
- ◆ Available as a solid lid or with a breather
- ◆ Universal thread has larger diameter to fit any tank thread

FEMALE-THREADED LIDS WITH GASKET

Part Number	Description
354230	4" lid - female threads w. breather
3542010	6" lid - female threaded, labyrinth breather, flat gasket
3542110	6" lid - female threaded, closed, flat gasket
354142	7" lid - female with locking flange for DOT
354120	8" lid - female threaded, closed
354320	8" lid - female threaded with hole for breather valve

FEMALE-THREADED TANK LID DIMENSIONS

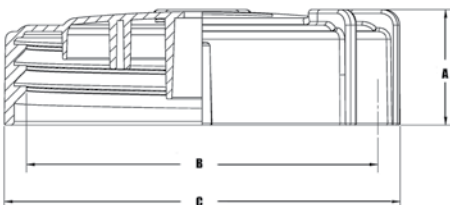

Part Number	A IN(MM)	B IN(MM)	C IN(MM)
354230	1.44 (36.5)	4.17 (106)	4.8 (122)
TL06-0003	1.85 (47)	5.66 (144)	6.35 (161)
TL06-0004	1.85 (47)	5.66 (144)	6.35 (161)

PROCAP TANK LIDS



- ◆ Easily mounted on a flat surface, the ProCap tank lids are available as a solid lid, with a labyrinth breather, or a bullet breather
- ◆ ProCap lid and ring assembly features DuraLok technology, a unique twist and lock closing system
- ◆ DuraLok gasket included.

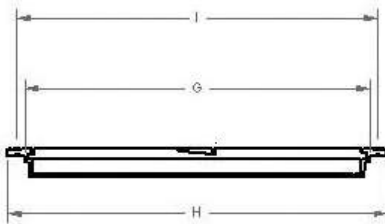
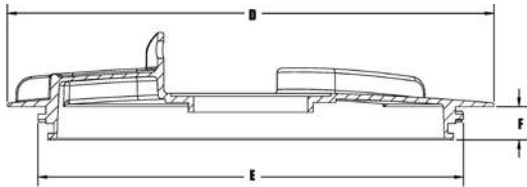

G = Inside diameter for leak content
H = Outside diameter
I = Screw hole diameter

TANK LIDS AND RING ASSEMBLIES WITH DURALOK™ TECHNOLOGY

Breather Type	8"	12"	16"
Solid Lid/Ring	TL08-0001	TL12-0001	TL16-0001
Labyrinth Lid/Ring	TL08-0002	TL12-0002	TL16-0002
Bullet Breather Lid/Ring	TL08-0003	TL12-0003	TL16-0003
Solid Lid	TL08-0011	TL12-0011	TL16-0011
Labyrinth Lid Only	TL08-0012	TL12-0012	TL16-0012
Bullet Breather Lid	TL08-0013	TL12-0013	TL16-0013
Ring Only	TL08-0014	TL12-0014	TL16-0014
Gasket	TLP-0007	TLP-0018	TLP-0023

DURALOK LID DIMENSIONS

Lid Size	D IN(MM)	E IN(MM)	F IN(MM)
8"	10(254)	8.3(210)	.96(24)
16"	18.1(460)	16.2(411)	.96(24)

DURALOK RING DIMENSIONS

Lid Size	I IN (mm)	G IN (mm)	H IN (mm)
8"	9.2 (284)	8.25 (210)	10.1 (257)
16"	17.4 (442)	16.3 (414)	18.3 (465)



180° HINGED TANK LIDS WITH DURALOK TECHNOLOGY

- ◆ Easily mounted on a flat surface, the ProCap tank lids are available with a labyrinth breather or a bullet breather
- ◆ ProCap hinged tank lids feature DuraLok technology, a unique twist and lock closing system
- ◆ Lids come standard with a locking hasp for added security
- ◆ The 180° hinged design allows the lid to open completely for easy tank access
- ◆ EPDM lid gasket is included

Breather Type	Lid Size	
	12"	16"
Labyrinth	TL12-0006	TL16-0006
Bullet	TL12-0007	TL16-0007
Gasket	TLP-0018	TLP-0023

TANK LIDS



Available as a solid lid or with a labyrinth breather

ARAG® MALE-THREADED TANK LIDS AND RING ASSEMBLIES (GASKETS NOT INCLUDED)

Breather Type	6"	8"	12"	16"	22"
Solid Lid/Ring	3522100-1	-	3522140-1	3522160-1	352180-1
Labyrinth Lid/Ring	-	3522221-1	3522040-1	3522060-1	352080-1
Solid Lid	3522100	3522120	3522140	3522160	352180
Lid with Labyrinth	3522000	3522221	3522040	3522060	352080
Ring - Standard	350401	3502420	3502440	3502460	350480
Ring with C Gasket	-	TLP-0046	350640	350660	350680
Sealing Gasket Between Tank & Ring	-	350420-020	350440-020	350460-020	350480-020
Wiper Gasket Between Lid & Ring	352000-020	3522120-020	3522140-020	3522160-020	-
C Gasket	-	350620-020	350640-020	TLP-0050	-

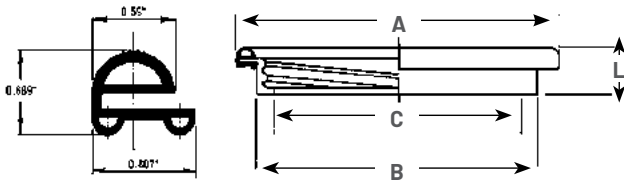
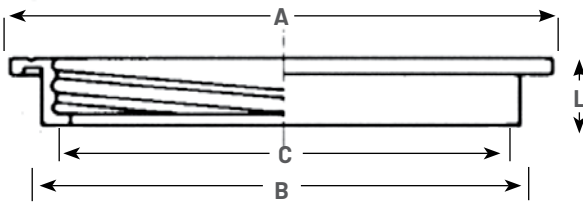
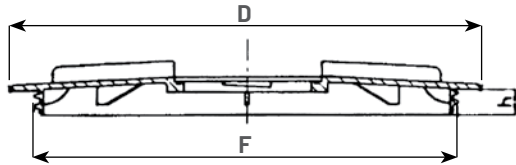

MALE-THREADED TANK LID DIMENSIONS

Lid Size	D IN/MM	F IN/MM	H IN/MM
6"	5.5/140	4.3/110	-
8"	9.8/250	8.3/210	1.2/31
12"	14.0/355	12.3/313	1.2/31
16"	17.9/454	16.1/410	1.0/25
22"	24.4/620	22.3/567	1.2/30

STANDARD RING DIMENSIONS

Lid Size	A IN/MM	B IN/MM	C IN/MM	L IN/MM
6"	6.3/159	4.9/125	4.4/112	0.7/17
8"	10.0/255	8.5/215	7.6/192	1.5/38
12"	14.2/360	12.6/320	11.4/290	1.5/38
16"	18.2/462	16.3/415	15.0/382	1.4/35
22"	24.4/620	22.6/575	21.3/540	1.6/41

RING WITH "C" GASKET DIMENSIONS

Lid Size	A IN/MM	B IN/MM	C IN/MM	L IN/MM
8"	10.0/255	8.5/215	7.6/192	1.5/38
12"	14.0/355	12.6/320	11.4/290	1.5/38
16"	18.1/460	16.3/415	15.0/382	1.4/35
22"	24.4/620	22.6/575	21.3/540	1.6/41

HINGED TANK LIDS (WIPER GASKET INCLUDED)

Part Number	Part Number	Size	Description
356040	Y01356040	12"	Hinged Lid/Ring with Bullet Breather
356041	-	12"	Hinged Lid/Ring with Bullet Breather and Locking Lid
356240	-	12"	Hinged Lid/Ring with Labyrinth Breather
356241	-	12"	Hinged Lid/Ring with Labyrinth Breather and Locking Lid
356060	0135606H	16"	Hinged Lid/Ring with Bullet Breather
356061	Y01356061	16"	Hinged Lid/Ring with Bullet Breather and Locking Lid
356260	-	16"	Hinged Lid/Ring with Labyrinth Breather
356261	-	16"	Hinged Lid/Ring with Labyrinth Breather

Available for order through HYPRO-EU only (Cambridge, UK)



GASKETS FOR HINGED TANK LIDS

Part Number	Description
356640-020NB	12" Wiper gasket for lid
3562060-090	Replacement wiper gasket for lid

ARAG HINGED DIMENSIONS

Lid Size	D-IN (mm)	B-IN (mm)	L-IN (mm)	M-IN (mm)	S-IN (mm)
12"	14.45 (367)	12.60 (320)	3.98 (101)	1.04 (26)	15.35 (390)
16"	18.19 (462)	16.34 (415)	3.98 (101)	1.04 (26)	19.13 (486)

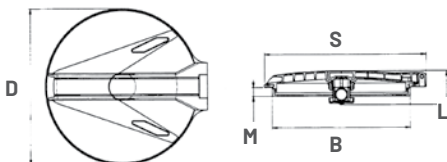

ARAG® is a registered trademark of ARAG.
Hypro® is a registered trademark of Pentair.

TANK ACCESSORIES



PROCLEAN HIGH PERFORMANCE TANK AND CONTAINER WASH NOZZLES

Part Number	Photo Reference	Description
PC1/2F-36075	A	ProClean container nozzle
30B4SNF70E35	B	ProClean Plus nozzle
PC1/2F-235120	C	ProClean tank nozzle
PV1/2F1/2M-MA	D	ProClean push-valve assembly
PC1/2F-36075-PV	A & D	ProClean container nozzle and valve
3400-0174	E	ProClean™ II Valve Assembly
BG-3400-0175	A & E	ProClean™ II Valve and Nozzle
3400-0176	F	ProClean™ II Valve Assembly with HF Nozzle

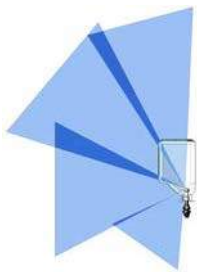

ProClean Container Nozzle

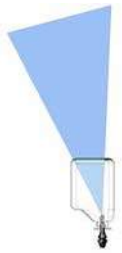

ProClean Plus Nozzle



ProClean Tank Nozzle

- ◆ ProClean tank and container nozzles are designed for better and faster cleaning of empty agrochemical containers and the inside of sprayer tanks
- ◆ Chemically-resistant and durable PVDF polymer construction
- ◆ ProClean Rotating Container Nozzle utilizes four fluid-driven rotating jets that target all corners of the container
- ◆ ProClean Plus Static Blade Container Nozzle has a powerful single blade jet that is directed upwards at 35°; Cuts through residues at the base of containers
- ◆ ProClean Rotating Tank Nozzle utilizes eight fluid-driven rotating jets that cover upper tank surfaces for complete rinsing
- ◆ Easy operation push-valve is activated with the same force regardless of liquid pressure

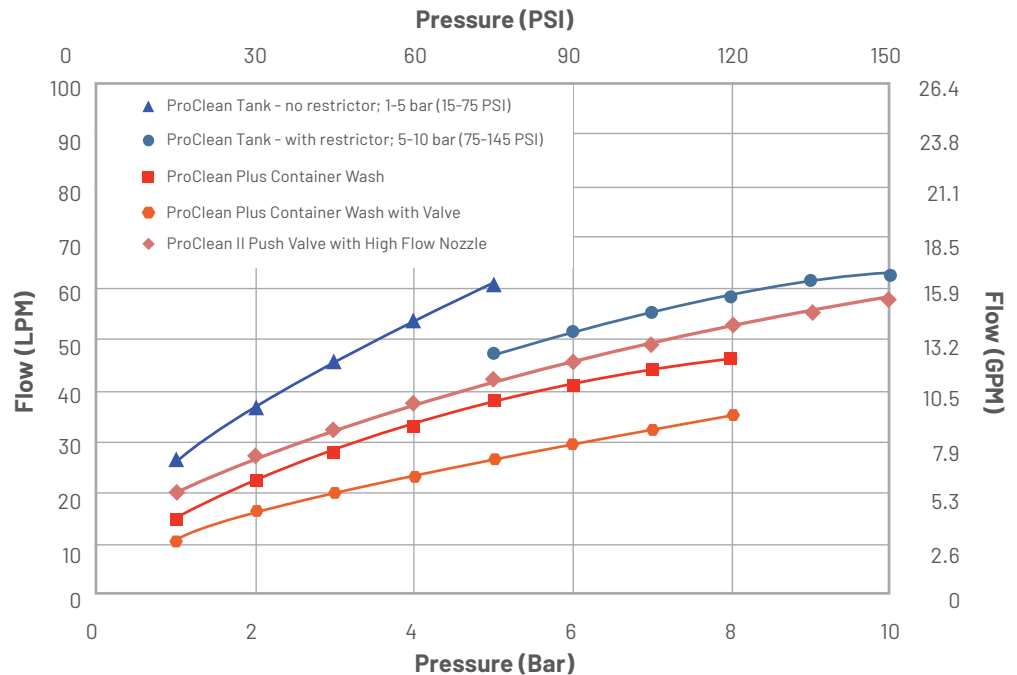

BASKET FILTERS

Part Number	Size	Basket Height mm(in)	Mesh
9950-55203	5.5"	203 (8")	18
9950-08050	8"	50 (2.0")	18
9950-08120	8"	120 (4.7")	18
9950-08240	8"	240 (9.4")	18
9950-12060	12"	60 (2.4")	18
9950-12240	12"	240 (9.4")	18
9950-16180	16"	180 (7.1")	18
9950-16280	16"	280 (11.0")	18
9950-16320	16"	320 (12.6")	18



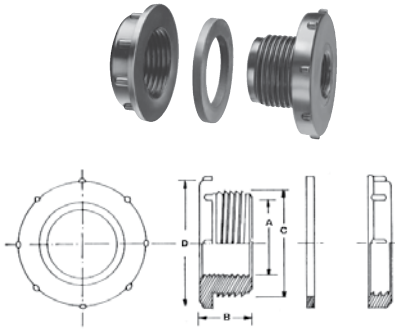

BULKHEAD FITTING

Part Number	A	B	C	D	Material	Gasket Part Number	Gasket Material
WBH12	1/2" NPT	1-3/16" (30 mm)	1-5/8" (41 mm)	2-3/4" (70 mm)	Polypropylene	WBH12/34GAS	Santoprene
WBH34	3/4" NPT	1-3/16" (30 mm)	1-5/8" (41 mm)	2-3/4" (70 mm)	Polypropylene	WBH12/34GAS	Santoprene
WBH100	1" NPT	1-7/8" (48 mm)	2-1/2" (52 mm)	2-7/8" (73 mm)	Polypropylene	WBH100GAS	Santoprene
WBH114	1-1/4" NPT	1-7/16" (37 mm)	2-1/2" (64 mm)	3-3/8" (86 mm)	Polypropylene	WBH114/112GAS	Santoprene
WBH112	1-1/2" NPT	1-7/16" (37 mm)	2-1/2" (64 mm)	3-3/8" (86 mm)	Polypropylene	WBH114/112GAS	Santoprene
WBH200	2" NPT	1-5/8" (41 mm)	3-1/8" (79 mm)	4-1/4" (108 mm)	Polypropylene	WBH200GAS	Santoprene
WBH300	3" NPT	1-3/4" (44 mm)	4-1/4" (108 mm)	5-1/2" (140 mm)	Polypropylene	-	-
WBH400	4" NPT	4-3/16" (106 mm)	5-1/2" (140 mm)	7" (178 mm)	Polypropylene	-	-

Add Prefix "BG-" for 1 part per retail bag.



JET AGITATORS

Part Number	Ref. Number	Thread	Max. Input: Output Ratio	Material
3371-0019	1	3/4" NPT (M) x 3/4" NPT (M)	3:9	Polypropylene
3371	2	1/2" NPT (F) in, 3/4" NPT (M) out	3:4	Polypropylene
3371-0028	3	3/4" NPT (M)(high volume)	5:1	Polypropylene
502069	5	1/2" NPT 9 mm Nozzle with Swivel	-	Polypropylene
52169	5	1/2" NPT 9 mm Nozzle	-	Polypropylene



LABYRINTH AIR VALVE

Part Number	Description
504203-HYP	Polypropylene Labyrinth Air Valve with 1" male connection
G40004	Gasket for installation in tank



FLOATING BALL VENT VALVE

Part Number	Description
504210*	Polypropylene Floating Ball Vent Valve

*2.35" tank hole dimension required for installation.

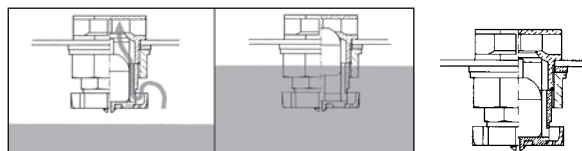

CLEANLOAD CHEMICAL EDUCTOR

For Safe Loading of Chemicals into Spray Tanks



3376 Series
Right hand flow shown.

- ◆ The Cleanload is a self-contained eduction system which allows the operator to mix liquid and dry chemicals safely and quickly
- ◆ All crop protection chemistry is mixed at ground level, ensuring the safety of both the operator and the environment
- ◆ Equipped with tank rinse, designed to completely wash the Cleanload hopper
- ◆ The ProClean II Push Valve is designed to self flush to help prevent sticking open or closed even with heavy particulates. Compatible with all ProClean series nozzles
- ◆ Optional suction lance allows the operator to educt bulk liquid and dry chemicals (wetttable powders, dry flowables and water-dispersible granules) from large containers without secondary handling
- ◆ See page 233 for performance information on all Cleanload models and Eductors

ORDER INFORMATION

Part Number	Tank Size	Eductor	Flow	Tank Rinse Style	Inlet/Outlet Connection Size	Bottle Rinse Assy	ISO Outlet Screen	Suction Lance
3376-0870	7 Gallon (26 Litre)	Turf/Diaphragm Poly - (08mm) High Pressure/Low Flow	Right Hand	Premium Sidewall Rinse System	220 Universal Flange	Yes	Yes	Optional Accessory
3376-0871	7 Gallon (26 Litre)	Turf/Diaphragm Poly - (08mm) High Pressure/Low Flow	Left Hand	Premium Sidewall Rinse System	220 Universal Flange	Yes	Yes	Optional Accessory
3376-1170	7 Gallon (26 Litre)	On-Board Sprayer Poly - (11mm) High Pressure/High Flow	Right Hand	Premium Sidewall Rinse System	220 Universal Flange	Yes	Yes	Optional Accessory
3376-1171	7 Gallon (26 Litre)	On-Board Sprayer Poly - (11mm) High Pressure/High Flow	Left Hand	Premium Sidewall Rinse System	220 Universal Flange	Yes	Yes	Optional Accessory
3376-1670	7 Gallon (26 Litre)	Transfer Pump Poly - (16mm) Low Pressure/High Flow	Right Hand	Premium Sidewall Rinse System	220 Universal Flange	Yes	Yes	Optional Accessory
3376-1671	7 Gallon (26 Litre)	Transfer Pump Poly - (16mm) Low Pressure/High Flow	Left Hand	Premium Sidewall Rinse System	220 Universal Flange	Yes	Yes	Optional Accessory
3430-0823	Suction Lance snaps into tank outlet for remote loading of bulk chemical containers							
3430-0807	16" Replacement tank lid							

Base for flat surface mounting. 1510-0135

CLOSED SYSTEM CLEANLOAD

Safe, Fast, & Simple Chemical Loading System



- ◆ Chemical loading system that is compliant with Closed System Regulation
- ◆ Enclosure accommodates many container sizes and fits up to two 2.5 gallon containers at one time
- ◆ Allows operator to re-seal partially used containers with the original chemical container cap
- ◆ Easily measure both large and small volumes of chemicals inside enclosure

ORDER INFORMATION:

Part Number	Application:	Nozzle	Frame
3377-1170	Sprayer Pump High Pressure/High Flow	11 mm	Yes
3377-1171			No
3377-1670	Transfer Pump Low Pressure/High Flow	16 mm	Yes
3377-1671			No

CLEANLOAD POLY OR STAINLESS STEEL EDUCTOR



POLY EDUCTOR:

- ◆ Market leading eduction rates designed for real world applications
- ◆ Optimizes system plumbing costs with an integrated 1/2" push-to-connect port for tank rinse
- ◆ One-piece polypropylene eductor assembly with mounting bosses and 220 Universal Flange ports
- ◆ Choose from three nozzle sizes along with right or left-hand push-to-connect orientation to fit your specific application
- ◆ Rinse port shown in right-hand configuration. Left-hand configuration is 180° from shown.

316 STAINLESS STEEL EDUCTOR:

- ◆ Inlet and outlet ports are flynut-ready, offering a wrench-free connection of hoses for easy installation and servicing
- ◆ Dual-ported to accommodate rinse port for either left-hand or right-hand flow orientation

ORDER INFORMATION

Part Number	Application	Nozzle	Rinse Port Orientation	Description
3371-0036	Turf & Diaphragm: High Pressure/Low Flow	8mm	Right Hand	Includes three 220 Universal Flange Gaskets and a 1/2" Push-to-Connect plug
3371-0036R			Right Hand	Eductor Only
3371-0037R			Left Hand	Eductor Only
3371-0038	On-Board Sprayer: High Pressure/High Flow	11mm	Right Hand	Includes three 220 Universal Flange Gaskets and a 1/2" Push-to-Connect plug
3371-0038R			Right Hand	Eductor Only
3371-0039R			Left Hand	Eductor Only
3371-0040	Transfer Pump: Low Pressure/High Flow	16mm	Right Hand	Includes three 220 Universal Flange Gaskets and a 1/2" Push-to-Connect plug
3371-0040R			Right Hand	Eductor Only
3371-0041R			Left Hand	Eductor Only
3371-0034S	On-Board Sprayer: High Pressure/High Flow	12mm	Dual Ported	316 Stainless Steel Eductor

PERFORMANCE FOR ALL CLEANLOAD MODELS AND EDUCTORS:

Eductor Material:	Poly												Stainless Steel												
	Turf / Diaphragm Pump: High Pressure - Low Flow				On-Board Sprayer Pump: High Pressure - High Flow				Transfer Pump: Low Pressure - High Flow				On-Board Sprayer Pump: High Pressure - High Flow												
Cleanload Part #:	3376-0870 & 3376-0871				3376-1170 & 3376-1171				3376-1670 & 3376-1671				3375 Models												
Eductor Part #:	3371-0036, -0036R & -0037R				3371-0038, -0038R & -0039R				3371-0040, -0040R & -0041R				3371-0034S												
Inlet Pressure	Req. Flow		Eduction Rate		Max Outlet Press		Req. Flow		Eduction Rate		Max Outlet Press		Req. Flow		Eduction Rate		Max Outlet Press								
	PSI	BAR	GPM	LPM	GPM	LPM	PSI	BAR	GPM	LPM	GPM	LPM	PSI	BAR	GPM	LPM	GPM	LPM	PSI	BAR					
10	0.7	-	-	-	-	-	-	-	-	-	-	-	-	-	-	-	-	-	-	-					
20	1.4	-	-	-	-	-	-	26.9	102	35.0	133	6.1	0.4	61.4	233	47.8	181	11.5	0.8	29.5	112	16.5	62	4.9	0.3
30	2.1	16.1	61	31.5	119	5.2	0.4	33.5	127	52.2	198	9.2	0.6	73.5	278	61.2	231	16.9	1.2	35.2	133	26.0	98	7.0	0.5
40	2.8	19.1	72	47.0	178	6.6	0.5	38.0	144	64.4	244	12.3	0.8	82.9	314	67.2	254	22.4	1.5	40.4	153	32.9	125	9.0	0.6
50	3.4	21.4	81	54.5	206	8.1	0.6	41.3	157	72.6	275	15.3	1.1	90.3	342	68.3	258	27.8	1.9	45.3	171	39.1	148	11.0	0.8
60	4.1	23.3	88	61.5	233	9.7	0.7	44.4	168	77.7	294	18.2	1.3	96.2	364	66.8	253	33.1	2.3	49.8	189	45.9	174	13.3	0.9
70	4.8	24.9	94	68.0	258	11.2	0.8	47.5	180	80.5	305	21.1	1.5	101.3	384	65.1	247	38.4	2.6	53.8	204	52.4	198	15.5	1.1
80	5.5	26.4	100	74.1	280	12.7	0.9	50.9	193	82.1	311	23.9	1.6	-	-	-	-	-	-	57.5	218	58.0	220	17.8	1.2
90	6.2	28.0	106	79.7	302	14.2	1.0	53.9	204	83.3	315	26.6	1.8	-	-	-	-	-	-	60.7	230	62.0	235	20.0	1.4
100	6.9	29.7	112	84.8	321	15.8	1.1	56.6	214	85.0	322	29.3	2.0	-	-	-	-	-	-	63.6	241	65.0	246	22.3	1.5

CLEANLOAD MAX

Safe, Fast, Batch Mixing and Loading System



- ◆ Large capacity education system with a low ergonomic working height for safe and fast batch mixing and loading of liquid and dry chemicals
- ◆ Modular design allows flexibility in building an education system using multiple Cleanload Max, standard Cleanloads and auxiliary components for bulk transfer
- ◆ 40 or 60 gallon, full draining, cone-bottomed tank for a 20:1 ratio with 800 or 1200 gallon sprayers
- ◆ Translucent tank with molded in graduations allows user to easily see fluid levels
- ◆ Market leading education rates allow operator to spend less time loading and more time spraying
- ◆ 2" or 3" bypass educator plumbing system allows for direct filling of sprayer tank when not educating chemicals
- ◆ CycloRinse and ProClean bottle rinse prevent cross contamination of chemicals
- ◆ Extends the life of transfer pumps by educating abrasive and corrosive chemicals downstream of the pump

CLEANLOAD MAX CHEMICAL EDUCATION SYSTEMS



Part Number	Tank Size	Eductor Size	Bypass Size
3378-1140	40 Gallon	11mm - Onboard Sprayer High Pressure/High Flow	None
3378-1140-2BYP			2"
3378-1140-3BYP			3"
3378-1640		16mm - Transfer Pump Low Pressure/High Flow	None
3378-1640-2BYP			2"
3378-1640-3BYP			3"
3378-1160	60 Gallon	11mm - Onboard Sprayer High Pressure/High Flow	None
3378-1160-2BYP			2"
3378-1160-3BYP			3"
3378-1660		16mm - Transfer Pump Low Pressure/High Flow	None
3378-1660-2BYP			2"
3378-1660-3BYP			3"

All eductors are set-up for right hand flow operation.

CLEANLOAD MAX BYPASS ASSEMBLIES



Part Number	Description	Bypass
3371-0044	11mm - Onboard Sprayer High Pressure/High Flow	2"
3371-0047		3"
3371-0045	16mm - Transfer Pump Low Pressure/High Flow	2"
3371-0046		3"

All eductors are set-up for right hand flow operation

CLEANLOAD MAX KITS

Part Number	Description
1510-0135	3376 Series Cleanload floor mount bracket
3430-0944	Tubing Repair Kit - 40 Gallon
3430-0945	Tubing Repair Kit - 60 Gallon

POLYPROPYLENE LINE STRAINERS

Rated for 80 psi at 70°F / 5.5 bar at 21°C



Part Number	NPT Threads	Replacement Parts for Polypropylene Line Strainers				
		Cap	Bowl	Screen	Mesh	O-ring
3350-0085A	1/4" I.D. (F) & 1/2" O.D. (M)	3351-0035	3351-0036	3800-0048	20 s.s.	1700-0090 EPDM
3350-0079A		3351-0035	3351-0036	3800-0046	50 s.s.	
3350-0082A		3351-0035	3351-0036	3800-0047	80 s.s.	
3350-0056A	1/2"	3351-0037	3351-0039	3800-0029	20 s.s.	1700-0091 EPDM
3350-0046A		3351-0037	3351-0039	3800-0025	50 s.s.	
3350-0043A		3351-0037	3351-0039	3800-0026	80 on 20 s.s.	
3350-0040A	3/4"	3351-0038	3351-0039	3800-0029	20 s.s.	1700-0091 EPDM
3350-0034A		3351-0038	3351-0039	3800-0025	50 s.s.	
3350-0035A		3351-0038	3351-0039	3800-0026	80 on 20 s.s.	
3350-0057A	1"	3351-0040	3351-0043	3800-0040	20 s.s.	1700-0092 EPDM
3350-0058A		3351-0040	3351-0043	3800-0041	50 s.s.	
3350-0059A		3351-0040	3351-0043	3800-0042	80 on 20 s.s.	
3350-0071A	1-1/4"	3351-0041	3351-0043	3800-0043	20 s.s.	1700-0092 EPDM
3350-0072A		3351-0041	3351-0043	3800-0044	50 s.s.	
3350-0073A		3351-0041	3351-0043	3800-0045	80 on 20 s.s.	
3350-0112A	1-1/2"	3351-0042	3351-0043	3800-0065	20 s.s.	1700-0092 EPDM
3350-0113A		3351-0042	3351-0043	3800-0066	50 s.s.	
3350-0114A		3351-0042	3351-0043	3800-0067	80 on 20 s.s.	

All 1/2", 3/4", 1-1/4" and 1-1/2" have internal (NPT) female ports, polypropylene cap and bowl.

POLYPROPYLENE LINE STRAINERS

Rated for 200 psi at 70°F / 14 bar at 21°C



NPT Part Number	BSP Part Number*	Max. PSI	Max. BAR	Threads	Previous Color	Screen Size/ Ref. Color	New ISO Color	Screen
3350-0142N	20N62230	290	20	1/2" FNPT	White	32 Mesh/White	Red	3800-0086
3350-0143N	20N62250				Blue	50 Mesh/Blue	Blue	3800-0087
3350-0144N	20N62280				Gray	80 Mesh/Gray	Yellow	3800-0088
3350-0145N	-				Red	100 Mesh/Red	Green	3800-0089
3350-0146N	20N62330	290	20	3/4" FNPT	White	32 Mesh/White	Red	3800-0086
3350-0147N	20N62350				Blue	50 Mesh/Blue	Blue	3800-0087
3350-0148N	20N62380				Gray	80 Mesh/Gray	Yellow	3800-0088
3350-0149N	-				Red	100 Mesh/Red	Green	3800-0089
3350-0150N	20N62430	290	20	1" FNPT	White	32 Mesh/White	Red	3800-0090
3350-0151N	20N62450				Blue	50 Mesh/Blue	Blue	3800-0091
3350-0152N	20N62480				Gray	80 Mesh/Gray	Yellow	3800-0092
3350-0153N	-				Red	100 Mesh/Red	Green	3800-0093
3350-0162N**	-	290	20	1" FNPT	White	32 Mesh/White	Red	3800-0090
3350-0163N**	-				Blue	50 Mesh/Blue	Blue	3800-0091
3350-0164N**	-				Gray	80 Mesh/Gray	Yellow	3800-0092
3350-0165N**	-				Red	100 Mesh/Red	Green	3800-0093
3350-0154N	20N62530	250	17	1-1/4" FNPT	White	32 Mesh/White	Red	3800-0094
3350-0155N	20N62550				Blue	50 Mesh/Blue	Blue	3800-0095
3350-0156N	20N62580				Gray	80 Mesh/Gray	Yellow	3800-0096
3350-0157N	-				Red	100 Mesh/Red	Green	3800-0097
3350-0166N**	203282152**	250	17	1-1/4" FNPT	White	32 Mesh/White	Red	3800-0094
3350-0167N**	203282153**				Blue	50 Mesh/Blue	Blue	3800-0095
3350-0168N**	2032821535**				Gray	80 Mesh/Gray	Yellow	3800-0096
3350-0169N**	-				Red	100 Mesh/Red	Green	3800-0097
3350-0158N	20N62630	250	17	1-1/2" FNPT	White	32 Mesh/White	Red	3800-0094
3350-0159N	20N62650				Blue	50 Mesh/Blue	Blue	3800-0095
3350-0160N	20N62680				Gray	80 Mesh/Gray	Yellow	3800-0096
3350-0161N	-				Red	100 Mesh/Red	Green	3800-0097
3350-0170N**	203282162**	250	17	1-1/2" FNPT	White	32 Mesh/White	Red	3800-0094
3350-0171N**	203282163**				Blue	50 Mesh/Blue	Blue	3800-0095
3350-0172N**	2032821635**				Gray	80 Mesh/Gray	Yellow	3800-0096
3350-0173N**	-				Red	100 Mesh/Red	Green	3800-0097

*Available for order through HYPRO-EU only (Cambridge, UK)

**Self-cleaning model.

NYLON LINE STRAINERS

Rated for 150 psi at 70°F / 10.34 bar at 21°C

Rated for 100 psi at 125°F / 6.9 bar at 51.6°C

140°F max./ 60°C max.



Part Number	NPT Threads	Replacement Parts for Nylon Line Strainers				
		Cap	Bowl	Screen	Mesh	O-ring
3350-0085	1/4" I.D. (F) & 1/2" O.D. (M)	3351-0022	3351-0020 (Clear)	3800-0048	20 s.s.	1700-0064 Buna-N
3350-0085F		3351-0022		3800-0048	20 s.s.	1700-0065 Viton
3350-0079		3351-0022		3800-0046	50 s.s.	1700-0064 Buna-N
3350-0079F		3351-0022		3800-0046	50 s.s.	1700-0065 Viton
3350-0082		3351-0022		3800-0047	80 s.s.	1700-0064 Buna-N
3350-0082F		3351-0022		3800-0047	80 s.s.	1700-0065 Viton
3350-0056	1/2" (F)	3351-0007	3351-0005 (White) or 3351-0015* (Clear)	3800-0029	20 s.s.	1700-0044 Buna-N
3350-0131		3351-0007		3800-0029	20 s.s.	1700-0045 Viton
3350-0046		3351-0007		3800-0025	50 s.s.	1700-0044 Buna-N
3350-0042		3351-0007		3800-0025	50 s.s.	1700-0045 Viton
3350-0043		3351-0007		3800-0026	80 on 20 s.s.	1700-0044 Buna-N
3350-0068		3351-0007		3800-0026	80 on 20 s.s.	1700-0045 Viton
3350-0040	3/4" (F)	3351-0006	3351-0005 (White) or 3351-0015* (Clear)	3800-0029	20 s.s.	1700-0044 Buna-N
3350-0132		3351-0006		3800-0029	20 s.s.	1700-0045 Viton
3350-0034		3351-0006		3800-0025	50 s.s.	1700-0044 Buna-N
3350-0044		3351-0006		3800-0025	50 s.s.	1700-0045 Viton
3350-0035		3351-0006		3800-0026	80 on 20 s.s.	1700-0044 Buna-N
3350-0045		3351-0006		3800-0026	80 on 20 s.s.	1700-0045 Viton
3350-0057	1" (F)	3351-0014	3351-0013 (White) or 3351-0024* (Clear)	3800-0040	20 s.s.	1700-0057 Buna-N
3350-0060		3351-0014		3800-0040	20 s.s.	1700-0058 Viton
3350-0058		3351-0014		3800-0041	50 s.s.	1700-0057 Buna-N
3350-0061		3351-0014		3800-0041	50 s.s.	1700-0058 Viton
3350-0059		3351-0014		3800-0042	80 on 20 s.s.	1700-0057 Buna-N
3350-0062		3351-0014		3800-0042	80 on 20 s.s.	1700-0058 Viton
3350-0071	1-1/4" (F)	3351-0016	3351-0013 (White) or 3351-0024* (Clear)	3800-0043	20 s.s.	1700-0057 Buna-N
3350-0074		3351-0016		3800-0043	20 s.s.	1700-0058 Viton
3350-0072		3351-0016		3800-0044	50 s.s.	1700-0057 Buna-N
3350-0075		3351-0016		3800-0044	50 s.s.	1700-0058 Viton
3350-0073		3351-0016		3800-0045	80 on 20 s.s.	1700-0057 Buna-N
3350-0076		3351-0016		3800-0045	80 on 20 s.s.	1700-0058 Viton
3350-0112	1-1/2" (F)	3351-0026	3351-0013 (White) or 3351-0024* (Clear)	3800-0065	20 s.s.	1700-0057 Buna-N
3350-0115		3351-0026		3800-0065	20 s.s.	1700-0058 Viton
3350-0113		3351-0026		3800-0066	50 s.s.	1700-0057 Buna-N
3350-0116		3351-0026		3800-0066	50 s.s.	1700-0058 Viton
3350-0114		3351-0026		3800-0067	80 on 20 s.s.	1700-0057 Buna-N
3350-0117		3351-0026		3800-0067	80 on 20 s.s.	1700-0058 Viton

* Clear Polyimide Bowl - Add Suffix "P" - (ie.: 3350-0057P) - 1/2", 3/4", 1", 1-1/4" and 1-1/2".
1/2", 3/4", 1", 1-1/4" and 1-1/2" have internal (NPT) Female Ports, Type 6 nylon cap bowl.

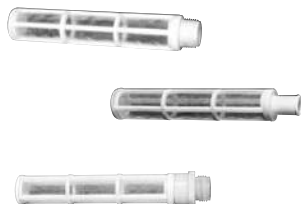

NYLON SUCTION STRAINERS

Part Number	Thread	Screen	Estimated Weight Ea.	
			US Units	Metric Units
3350-0069	3/4" NPT (M)	50-mesh nylon	4 oz.	114 g
3350-0032	3/4" (19 mm) hose barb (all nylon)	50-mesh nylon	4 oz.	114 g
3350-0077	garden hose (M)	50-mesh nylon	4 oz.	114 g

ADJUSTABLE PATTERN SPRAY GUNS

3381-0016

- ◆ Adjustable pattern spray gun
- ◆ 15" (38 cm) barrel
- ◆ 3mm nozzle
- ◆ 3/8" (10 mm) MNPT inlet
- ◆ Sized for spot spraying



ORDER INFORMATION

Part Number	Max PSI	Max BAR	Max GPM	Max LPM
3381-0016	120	8	1	4

3381-0021

- ◆ Adjustable pattern spray gun
- ◆ 21" (53 cm) barrel
- ◆ 3mm nozzle
- ◆ 3/8" (10 mm) and 1/2" (13 mm) hose barb
- ◆ Sized for spot spraying



ORDER INFORMATION

Part Number	Max PSI	Max BAR	Max GPM	Max LPM
3381-0021	60	4	1	4

3381-0036

- ◆ Adjustable pattern spray gun
- ◆ 19" (48 cm) barrel
- ◆ 3mm nozzle
- ◆ 3/8" (10 mm) hose barb



ORDER INFORMATION

Part Number	Max PSI	Max BAR	Max GPM	Max LPM
3381-0036	120	8	2.5	10

3381-0043 & 3381-0043L

- ◆ Adjustable pattern spray gun
- ◆ 7-1/4" (18 cm) or 18" (45 cm) barrel
- ◆ 2.3mm nozzle
- ◆ 3/8" (10 mm) and 1/2" (13 mm) hose barb



ORDER INFORMATION

Part Number	Barrel Length		Max PSI	Max BAR	Max GPM	Max LPM
	US Units	Metric Units				
3381-0043	7-1/4"	18 cm	600	40	11	18
3381-0043L	18"	45 cm	600	40	11	18
9920-261703-69	Replacement Barrel for 3381-0043					
9920-35.1703.67	Replacement Barrel for 3381-0043L					
3430-0768	Replacement nozzle kit					

SPRAY GUN NOZZLES FOR 3381-0043 AND 3381-0043L GUNS

Part Number	Orifice	Performance	45 PSI		100 PSI		150 PSI		200 PSI		300 PSI		450 PSI		600 PSI	
			Cone	Straight	Cone	Straight	Cone	Straight	Cone	Straight	Cone	Straight	Cone	Straight	Cone	Straight
AMT-15010 replaces 9920-61.1802.45	1.0 mm	GPM spray angle throw, ft	0.24 30° 3.2	0.24 - 8.2	0.35 30° 4.9	0.37 - 13.0	0.40 40° 6.5	0.45 - 18.0	0.53 40° 6.5	0.60 - 18.5	0.57 40° 6.5	0.60 - 19.5	0.70 40° 7.2	0.75 - 21.0	0.83 38° 8.2	0.90 - 23.0
AMT-15012 replaces 9920-61.1802.46	1.2 mm	GPM spray angle throw, ft	0.35 32° 3.9	0.38 - 9.8	0.55 35° 5.5	0.55 - 14.5	0.60 45° 7.2	0.65 - 20.0	0.80 42° 7.2	0.93 - 21.0	0.88 42° 7.2	0.90 - 22.0	1.10 40° 8.2	1.20 - 23.5	1.30 40° 8.2	1.40 - 25.5
AMT-15015 replaces 9920-61.1802.47	1.5 mm	GPM spray angle throw, ft	0.40 32° 3.9	0.50 - 11.5	0.62 35° 6.5	0.80 - 14.5	0.62 45° 8.2	0.93 - 23.0	0.95 45° 8.2	1.25 - 24.0	1.00 42° 8.2	1.30 - 24.5	1.30 42° 8.2	1.70 - 26.0	1.50 42° 10.0	1.95 - 28.0
AMT-15018 replaces 9920-61.1802.48	1.8 mm	GPM spray angle throw, ft	0.50 40° 4.9	0.75 - 13.0	0.73 42° 6.5	1.20 - 16.5	0.85 50° 8.2	1.35 - 26.0	1.15 45° 8.2	1.75 - 27.0	1.20 50° 8.2	1.90 - 28.0	1.60 48° 9.8	2.30 - 31.0	1.75 48° 10.0	2.80 - 33.0
AMT-15020 replaces 9920-61.1802.55	2.0 mm	GPM spray angle throw, ft	0.73 40° 3.9	1.10 - 14.5	1.05 42° 6.0	1.60 - 19.5	1.30 55° 8.2	1.90 - 29.5	1.50 55° 8.2	2.40 - 30.5	1.60 55° 8.2	2.50 - 31.0	1.90 53° 9.8	3.00 - 34.0	2.20 50° 10.0	3.50 - 36.0
AMT-15023 replaces 9920-61.1802.68	2.3 mm	GPM spray angle throw, ft	0.90 40° 4.9	1.40 - 16.5	1.30 42° 6.5	1.90 - 24.5	1.50 55° 10.0	2.30 - 32.0	2.00 55° 10.0	3.20 - 35.0	2.10 55° 10.0	3.30 - 36.0	2.70 53° 9.8	4.10 - 38.0	3.10 51° 10.5	4.80 - 39.0
9920-61.1802.45	4.0 mm	GPM throw, ft	-	-	-	-	1.9 10	3.4 36	-	-	4.6 10	8.0 38	5.5 10	9.5 40	6.3 12	11.0 40

ADJUSTABLE PATTERN SPRAY GUNS

3381-0010 AND 3381-0011

- ◆ Adjustable pattern spray gun
- ◆ 17" (43 cm) or 21" (53 cm) barrel
- ◆ 3mm or 4mm nozzle
- ◆ 1/2" (13 mm) MNPT inlet



3381-0013

- ◆ Adjustable pattern spray gun
- ◆ 7" (18 cm) barrel
- ◆ 3mm nozzle
- ◆ 1/2" (13 mm) MNPT inlet



ORDER INFORMATION

Part Number	Barrel Length		Nozzle	Max PSI	Max BAR	Max GPM	Max LPM
	US Units	Metric Units					
3381-0010	17"	43 cm	3mm	1200	83	25	95
3381-0011	21"	53 cm	4mm	1200	83	30	114
9920-KIT10/11	Repair Kit						
9920-248	Swivel Kit (1/2" FNPT x 1/2" MBSP)						

ORDER INFORMATION

Part Number	Max PSI	Max BAR	Max GPM	Max LPM
3381-0013	700	40	19	72
9920-248	Swivel Kit (1/2" FNPT x 1/2" MBSP)			

TREE SPRAYING GUIDE HYPRO DIAPHRAGM PUMP GAS ENGINE APPLICATIONS

Spray Height	Pump/Engine Model	Engine	Shaft	Spray Gun	Nozzle
30-35 ft.	9910-D252GRGI58 (w/o engine)	Min. 2.5 hp SAE j609a flange mount	5/8" 3/4" 5/8" 3/4"	3381-0010 or 3381-0013	3385-3000
	9910-D252GRGI (w/o engine)				
	D252GRGI-25 (w/2.5 hp PowerPro™)				
	D252GRGI-55 (w/5.5 hp PowerPro™)				
6 GPM; 290 PSI					
35-40 ft.	9910-D30GRGI (w/o engine)	Min. 5.0 hp SAE j609a flange mount	3/4" 3/4" 3/4" 3/4"	3381-0010 or 3381-0013	3385-3000
	D30GRGI-65 (w/6.5 hp PowerPro™)				
	D30HRGI-65 (w/6.5 hp PowerPro™)				
	D30HRGI-65E (w/6.5 hp PowerPro™)				
9.5 GPM; 580 PSI					
45-50 ft.	9910-D50 (w/o engine, controller or gearbox)	Min 8.0 hp SAE j609a flange mount	1"	3381-0011	3385-4000
14 gpm; 580 psi					
45-50 ft.	9910-D503GRGI (w/o engine)	Min 8.0 hp SAE j609a flange mount	1"	3381-0011	3385-4000
15 gpm; 580 psi					
50-57 ft.	9910-D813GRGI (w/o engine)	Min 14.0 hp SAE j609a flange mount	1"	3381-0011	3385-4500
21 gpm; 725 psi					
60-68 ft.	9910-D1064GRGI (w/o engine)	Min 18.0 hp SAE j609a flange mount	1"	3381-0011	3385-6000
28 gpm; 725 psi					

All GRGI pump models come complete with gear reduction and control valve.

PERFORMANCE CHART FOR MODELS 3381-0010, 3381-0011 AND 3381-0013 SPRAY GUNS

Hypro Model Number	Orifice Diameter In MM	Pressure In PSI** Performance	200 PSI Setting		350 PSI Setting		500 PSI Setting		600 PSI Setting		650 PSI Setting		700 PSI Setting		850 PSI Setting	
			Cone	Straight	Cone	Straight	Cone	Straight	Cone	Straight	Cone	Straight	Cone	Straight	Cone	Straight
3385-1500	1.5	capacity in gpm max throw (ft)*	1.14	1.26	1.48	1.7	1.8	2	1.9	2.2	2	2.3	2.1	2.4	2.2	2.5
			9.2	21.5	10.3	25.2	11.2	28	12.1	31.8	12.1	32	12.3	32.3	13.1	34.3
3385-2300	2.3	capacity in gpm max throw (ft)*	2.1	2.7	2.7	3.7	3.4	4.5	3.8	4.9	3.8	5	3.9	5.1	4.2	5.8
			11.4	29	12.9	33.9	14.8	37.9	16.6	41.5	17	41.7	17.7	42	19	45.7
3385-3000	3	capacity in gpm max throw (ft)*	2.9	4.6	3.7	6.3	4.8	7.5	5.2	8.4	5.3	8.5	5.4	8.6	6	9.6
			11.7	29.2	12.9	33.9	13.8	36.2	15.6	40.8	16	40.7	16.2	42	17	44.1
3385-3500	3.5	capacity in gpm max throw (ft)*	5.8	6	7.9	8.2	9.6	9.9	10.7	11.1	11	11.3	11.2	11.6	12.4	12.8
			13.6	36.2	19	41.2	22.6	45.3	25.5	50	25.5	51	27	51.5	28.8	54
3385-4000	4	capacity in gpm max throw (ft)*	7	7.3	9.6	9.9	11.6	12	12.9	13.5	13.2	13.8	13.6	14.1	15	15.6
			15.1	37.7	20.6	42.8	24.3	47	27.2	53	27.2	54	28.5	55	29	59
3385-4500	4.5	capacity in gpm max throw (ft)*	8.2	8.9	11.1	12	13.4	14.5	15	16.3	15.4	16.6	15.7	17	17.4	18.9
			18.1	39.2	22.2	44.3	26	50.1	30.6	54	30.6	56	31	57	31.5	62
3385-5000	5	capacity in gpm max throw (ft)*	9.8	10.2	13.3	13.8	16	16.7	18	18.7	18.4	19.1	18.9	19.5	20.8	21.6
			19.6	40.7	23.8	47	27.5	53.3	32.3	59	32.3	61	32.8	62	32.8	67
3385-5500	5.5	capacity in gpm max throw (ft)*	10.7	11.5	14.4	15.6	17.4	18.8	19.6	21	20	21.5	20.4	22	22.6	24.4
			19.6	42.2	23.8	50.7	29	57	34	63	34	64	34.5	65	34.5	70
3385-6000	6	capacity in gpm max throw (ft)*	11.5	12.6	15.6	17.1	18.8	20.6	21	23.2	21.5	23.7	22	24.2	24.4	26.
			21.1	43.7	25.3	54	30.7	60	35.6	66	35.6	67	36	68	36	974
3385-7000	7	capacity in gpm max throw (ft)*	11.5	13.5	15.6	18.4	18.8	22.2	21	25	21.5	25.4	22	26	24.4	29
			21.1	46.8	25.3	57	30.7	63	37.4	70	37.4	71	38	72	38	77

* Figures shown are guidelines for vertical throw.

** Pressures based on relief valve settings at straight throw.

ADJUSTABLE PATTERN SPRAY GUNS

LONG RANGE HIGH PRESSURE SPRAY GUN



- ◆ Brass body
- ◆ Stainless steel pipe
- ◆ Handle and nozzle protection in high-resistance polymer
- ◆ Ergonomic handgrip
- ◆ Quick-release trigger lock
- ◆ Swivel inlet port
- ◆ Adjustable spray pattern from hollow cone to solid stream

TOP GUN

Part Number	Max.PSI	Max.BAR	Max.GPM	Max.LPM	Nozzle Size	Nozzle Number	Connection		Estimated Weight Ea.	
							US Units	Metric Units	US Units	Metric Units
002201-3430	850	60	35.0	130	3.0 mm	003430	1/2" HB	13 mm	3 lbs. 8 oz.	13 kg
002201-3440	850	60	35.0	130	4.0 mm	003440	1/2" HB	13 mm	3 lbs. 8 oz.	13 kg
002201-3460	850	60	35.0	130	6.0 mm	003460	1/2" HB	13 mm	3 lbs. 8 oz.	13 kg
002201-3470	850	60	35.0	130	7.0 mm	003470	1/2" HB	13 mm	3 lbs. 8 oz.	13 kg

Hose barb and nut kit (sold separately): 3/8" - 006320; 1/2" - 006330.

PRESSURE (PSI)

Nozzle Size		200 PSI		350 PSI		500 PSI		600 PSI		720 PSI	
		Cone	Straight	Cone	Straight	Cone	Straight	Cone	Straight	Cone	Straight
3.0 mm	Flow GPM	3.8	5.2	5.6	6.8	6.6	8.5	7	9.2	7.3	10
	Max. throw ft.	12	36	13	37	15	41	16	44	21	46
4.0 mm	Flow GPM	6	8.2	7.3	12.7	8.6	13.2	10.2	14.5	11.4	15.9
	Max. throw ft.	14	42	15	44	16	49	19	52	23	57
6.0 mm	Flow GPM	9	16	11.5	22.2	14	25.8	15.5	26.7	16.2	27.5
	Max. throw ft.	19	59	21	62	25	66	26	68	31	72
7.0 mm	Flow GPM	10.5	17.5	13.8	25.7	16.8	30.6	18.2	33.2	20.3	34.3
	Max. throw ft.	21	60	23	67	26	72	27	77	31	82

ECONO GUN



Part Number	Max.PSI	Max.BAR	Max.GPM	Max.LPM	Connection	
					US Units	Metric Units
506532V	150	10	40.0	150	1/2" HB	13 mm
506530V	150	10	40.0	150	3/4" HB	19 mm
506531V	150	10	40.0	150	1" HB	25 mm

SPRAY GUNS & LANCES



3381-0018W

18 GUN

- ◆ Fast, easy servicing
- ◆ Stainless steel ball, seat, spring and glands
- ◆ Durable insulated handle; Rear entry
- ◆ Reduced trigger pressure; Less operator fatigue
- ◆ Consistent weep control at 1/4 gpm (+/-15%) on "W" version

Part Number	Inlet/Outlet	Max. PSI	Max. BAR	Max. GPM	Max. LPM	Max Temp	Max Temp
3381-0018	3/8" (F)NPT x 1/4" (F)NPT	4000	280	9.0	34	300° F	150° C
3381-0018W*							

* Weep Version



3381-0032W

32 GUN

- ◆ Stainless steel ball, seat, spring and glands
- ◆ Durable insulated handle; Rear entry
- ◆ Reduced trigger pressure; Less operator fatigue
- ◆ Consistent weep control at 1/4 gpm (+/-15%) on "W" version

DUAL LANCE

- ◆ Insulated lance; insulated selector handle
- ◆ Dual-molded nozzle protectors
- ◆ 40" length, rotating handle for proper hi/lo nozzle control "W" version
- ◆ Chrome plated



Part Number	Inlet/Outlet	Max. PSI	Max. BAR	Max. GPM	Max. LPM	Max Temp	Max Temp
3381-0032	3/8" (F)NPT x 1/4" (F)NPT	4000	280	7.0	27	300° F	150° C
3381-0032W*							

* Weep Version

Part Number	Inlet/Outlet	Max. PSI	Max. BAR	Max. GPM	Max. LPM	Max Temp	Max Temp
3365-0002	1/4" (M)NPT x Dual 1/4" (M)	3000	210	10.5	40	300° F	150° C



ZINC-PLATED BENT SINGLE LANCES W/ INSULATED HANDLE

Length	Part Number	Inlet/Outlet	Max. PSI	Max. BAR	Max. GPM	Max. LPM	Max Temp	Max Temp	
24"	61 cm	3365-0004/24	1/4" (M) NPT	3600	250	10.5	40	300° F	150° C
36"	91 cm	3365-0004/36							
47"	119 cm	3365-0004/47							

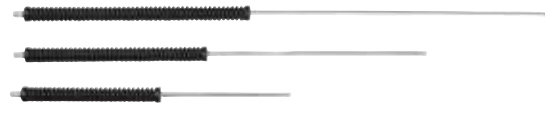

ZINC-PLATED STRAIGHT SINGLE LANCES W/ INSULATED HANDLE

Length	Part Number	Inlet/Outlet	Max. PSI	Max. BAR	Max. GPM	Max. LPM	Max Temp	Max Temp	
24"	61 cm	3365-0005/24	3/8" (M) NPTx 1/4" (F) NPT	3600	250	10.5	40	300° F	150° C
36"	91 cm	3365-0005/36							
47"	119 cm	3365-0005/47							



- ◆ Stainless steel ball, seat, spring and glands
- ◆ Durable insulated handle
- ◆ Reduce trigger pressure; Less operator fatigue
- ◆ 16" Insulated lance length w/screw coupling

REAR ENTRY SPRAY GUN WITH BLACK LANCES & COUPLER

Part Number	Inlet/Outlet	Max. PSI	Max. BAR	Max. GPM	Max. LPM	Max Temp	Max Temp
3381-0034	3/8" (F) NPT x Quick Coupling (screw type)	3500	240	7.0	27	300° F	150° C



ZINC-PLATED LANCE EXTENSIONS FOR 3381 - 0034 GUN

Length	Part Number	Inlet/Outlet	Max. PSI	Max. BAR	Max. GPM	Max. LPM	Max Temp	Max Temp	
14"	36 cm	3365-0007/14	Quick Coupling x 1/4" (M) NPT	3500	240	10.5	40	300° F	150° C
24"	61 cm	3365-0007/24							
36"	91 cm	3365-0007/36							

NOZZLES



- ◆ Variable fan pattern, 0° to 80°
- ◆ Push/Pull for pressure adjustment to draw soap
- ◆ Twist for fan adjustment

HI-LO VARIABLE NOZZLE

Part Number		Nozzle No.	Inlet (NPT)	Max PSI	Max Bar	Max GPM	Max LPM	Max Temp	Max Temp
Variable	Hi-Lo Variable								
-	3324-2000.85	2.0	1/4" (F)	3000	210	8.0	30	300° F	150° C
3324-1001.05	3324-2001.05	3.0							
3324-1001.1	3324-2001.1	3.5							
3324-1001.15	3324-2001.15	3.7							
3324-1001.2	3324-2001.2	4.0							
3324-1001.25	3324-2001.25	4.3							
3324-1001.3	3324-2001.3	4.6							
3324-1001.35	3324-2001.35	5.0							
3324-1001.4	3324-2001.4	5.3							
3324-1001.45	3324-2001.45	5.6							
3324-1001.5	3324-2001.5	6.0							

Hypro Part Number		Nozzle Capacity (GPM) at Pump Pressure (PSI)													
Variable	Hi-Lo Variable	Nozzle No.	Orifice Diameter		PSI										
			mm	inches	600	700	800	900	1000	1200	1500	1800	2000	2500	3000
3324-1000.85	3324-2000.85	2.0	.085	.033	.077	0.80	.089	.095	1.00	1.10	1.20	1.35	1.40	1.40	.033
3324-1001.05	3324-2001.05	3.0	1.05	.041	1.22	1.30	1.37	1.45	1.52	1.66	1.86	2.04	2.16	2.42	2.64
3324-1001.1	3324-2001.1	3.5	1.10	.043	1.35	1.43	1.52	1.60	1.68	1.84	2.06	2.26	2.39	2.67	2.91
3324-1001.2	3324-2001.2	4.0	1.20	.047	1.60	1.70	1.80	1.90	2.00	2.19	2.45	2.69	2.84	3.17	3.44
3324-1001.25	3324-2001.25	4.3	1.25	.049	1.72	1.83	1.94	2.05	2.16	2.36	2.64	2.90	3.06	3.41	3.70
3324-1001.3	3324-2001.3	4.6	1.30	.051	1.85	1.97	2.09	2.21	2.32	2.54	2.84	3.12	3.29	3.66	3.96
3324-1001.35	3324-2001.35	5.0	1.35	.053	1.97	2.10	2.23	2.36	2.48	2.71	3.04	3.34	3.52	3.92	4.23
3324-1001.4	3324-2001.4	5.3	1.40	.055	2.09	2.23	2.37	2.50	2.63	2.89	3.23	3.55	3.74	4.16	4.49
3324-1001.45	3324-2001.45	5.6	1.45	.057	2.22	2.37	2.52	2.66	2.80	3.06	3.43	3.77	3.97	4.41	4.79
3324-1001.5	3324-2001.5	6.0	1.50	.059	2.34	2.50	2.66	2.81	2.96	3.24	3.63	3.99	4.20	4.66	5.02

Note: Capacity figures shown are with water at 70°F. There may be variations due to power supply, temperature, viscosity, additives, etc.

MEASUREMENT COMPONENTS

Orion® Flowmeters



New digital technology converts fluid ion flow into gpm/lpm, virtually making mechanical flowmeters obsolete. These precise flowmeters work by utilizing sensors to relay pulse signals and converting them into gpm/lpm readings. The Visual-Flow flowmeter, with touch pad, displays instant flow reading for quantity of fluid filled.

- ◆ No mechanical moving parts
- ◆ Advanced technology at an affordable price
- ◆ Performance independent from fluid density and viscosity
- ◆ Low sensitivity to turbulence
- ◆ Wide variety of flows for use in diverse applications
- ◆ High precision, typical error is 0.5%
- ◆ Pulse output is 0-12 volts, max. consumption of 300 mA (milliamps)
- ◆ Accuracy and precision saves chemical throughout the life of the system
- ◆ Working pressure up to 580 psi (40 bar)
- ◆ Integrates with existing rate controllers
- ◆ AMP® Super Seal™ connection

1-VISUAL-FLOW FLOWMETER WITH MALE THREAD ADAPTERS

Part Number	Part Number	Flow (GPM)	Flow (L/min)	Size	Max PSI	Max BAR
4621BA01313	-	0.13 - 2.6	.5-10	3/4"	290	20
4621BA11313	-	0.3 - 5	1-20	3/4"	290	20
4622BA51616	464622BA51616	5 - 106	20-400	1-1/2"	290	20
4622BA61717	464622BA61717	8 - 158	30-600	2"	290	20

Available for order through HYPRO-EU only (Cambridge, UK)

2-ORION FLOWMETER WITH MALE THREAD ADAPTERS

Part Number	Part Number	Flow (GPM)	Flow (L/min)	Size	Max PSI	Max BAR
4621AA11313	-	.3 - 5	1-20	3/4"	290	20
4621AA31414	-	1.4 - 26	5-100	1"	290	20
4621AA41414	-	2.6 - 53	10-200	1"	290	20
4621AA41515	-	2.6 - 53	10-200	1-1/4"	290	20
4622AA51616	464622AA51616	5 - 106	20-400	1-1/2"	290	20
4622AA61717	464622AA61717	8 - 158	30-600	2"	290	20

Available for order through HYPRO-EU only (Cambridge, UK)

3-ORION FLOWMETER ONLY

Part Number	Part Number	Flow (GPM)	Flow (L/min)	Max PSI	Max BAR	Adapter Series
4621AA30000	464621AA30000	1.3 - 26	5-100	580	40	463
4622AA40000	-	2.6 - 53	10-200	580	40	473

Bolt Kit, VIM258-FM, includes stainless steel bolts, washers and lock nuts.

Available for order through HYPRO-EU only (Cambridge, UK)

ADAPTER CABLES

Part Number	Reference Number	Description
AE2650	A	Orion to Raven® (Conxall®)
AE2652	B	Orion to John Deere (Packard®)
AE2654	C	Orion to MidTech (Packard Weather Pack®)
4622BA50000-100	*	4 pin, 10' extension cable (Visual-Flow)*
4622BA50000-200	*	4 pin cable w/pump stop unit (Visual-Flow)*

*Not shown.

Orion® is a registered trademark of ARAG.

Raven® is a registered trademark of Raven Industry

Conxall® is a registered trademark of Conxall Corp.

TeeJet® is a registered trademark of Spraying Systems Co.

Packard® is a registered trademark of Delphi

Packard Weather Pack® is a registered trademark of Delphi





ELECTRIC PROPORTIONAL SPRAY CONTROL VALVES

Part Number	Part Number	Series	Max.GPM*	Max.PSI*	Open to Close	Outlet Size
463020	46463020	863	12	580	14 seconds	3/4" HB
8630020S	-	863	12	580	7 seconds	3/4" HB
8630024S	46463024	863	12	580	14 seconds	3/4" HB
8630024S	-	863	12	580	14 seconds	3/4" HB

* Max GPM per valve section.
Available for order through HYPRO-EU only (Cambridge, UK)



ELECTRIC 3-WIRE BOOM SECTION VALVE

Part Number	Series	Max.GPM*	Max.PSI*	Open to Close	Outlet Size
8630001	463/863	12	290	0.6 seconds	1/2" HB
8630011**	463/863	12	290	0.6 seconds	3/4" HB

* Max GPM per valve section. **Includes bypass port.



MANUAL PROPORTIONAL SPRAY CONTROL VALVES

Part Number	Part Number	Series	Max.GPM*	Max.PSI*	Outlet Size
473070	46473070	473	31	580	1/4" HB

* Max GPM per valve section.
Available for order through HYPRO-EU only (Cambridge, UK)



MANUAL PRESSURE REGULATING VALVES

Part Number	Series	Max.GPM*	Max.PSI*	Outlet Size
463080N	463	12	290	3/4" HB

* Max GPM per valve section.



MANUAL BOOM SECTION VALVES

Part Number	Part Number	Series	Max.GPM*	Max.PSI*	Metered Bypass	Outlet Size
463051	46463051	463	12	290	No	3/4" HB
463061	46463061	463	12	290	Yes	3/4" HB

* Max GPM per valve section.
Available for order through HYPRO-EU only (Cambridge, UK)



SERIES 461 - ECONOMIC MANUAL VALVE ASSEMBLIES

Part Number	Valves*	Max.GPM*	Max.PSI*	Inlet Size	Outlet Size	Regulator
461031-1	3	12	290	1" HB	1/2" HB	No
461031-2	3	12	290	1" HB	3/4" HB	No
461031-3	3	12	290	1/2" HB	1/2" HB	No
461021-1	2	12	290	1" HB	1/2" HB	No

*Includes flynut inlet and hose barb outlets in sizes indicated.
**Supplied with 3/4" elbow HB, 3/4" straight HB and 1/2" straight HB inlets and 3/4" FNPT, 3/4" HB, 1/2" HB and 3/8" HB outlets.

HYPRO® SPRAYER CONTROL VALVES



ELECTRIC PROPORTIONAL SPRAY CONTROL VALVE

Part Number	Max.GPM	Max.PSI	Open to Close	Outlet Size
3470-0104	26	580	7 seconds	Outlet port sold separately (See below)



ELECTRIC 3-WIRE BOOM SECTION VALVES

Part Number	Max.GPM	Max.PSI	Open to Close	Metered Bypass	Outlet Size
3470-0106	12	290	0.2 seconds	Yes	Outlet port sold separately (See below)
3470-0101	12	290	0.2 seconds	No	Outlet port sold separately (See below)



MANUAL PROPORTIONAL SPRAY CONTROL

Part Number	Max.GPM	Max.PSI	Outlet Size
3470-0103	26	580	3/4" HB



MANUAL PRESSURE REGULATING VALVE

Part Number	Max.GPM	Max.PSI	Outlet Size
3470-0102	26	290	Outlet port sold separately (See below)



MANUAL BOOM SECTION VALVE

Part Number	Max.GPM	Max.PSI	Outlet Size
3470-0107	12	290	Outlet port sold separately (See below)



OUTLET PORTS FOR VALVES

Part Number	Max.GPM	Max.PSI	Outlet Size
3470-0206	12	290	3/8" HB
3470-0201	12	290	1/2" HB
3470-0202	12	290	3/4" HB
3470-0204	12	290	1" HB
3470-0203	12	290	3/4" FNPT
3470-0207	12	290	1/2" HB-90° Elbow

3470-0208 O ring sold separately.



REPLACEMENT CLIPS & O-RINGS

Part Number	Description
3470-0208	Replacement O-ring
3470-0209	Replacement clip



VALVE INLET MALE ADAPTERS

Part Number	Description	Ref #
3470-0305	Adapter Female Side Male 3/4" BSP	-
3470-0306	Adapter Female Side Male 1" BSP	-
3470-0307	Adapter Male Side Male 3/4" BSP	-
3470-0308	Adapter Male Side Male 1" BSP	-
3470-0301	Adapter Female Side Female 3/4" NPT	1
3470-0302	Adapter Female Side Female 1" NPT	1
3470-0401	Adapter Male Side Female 3/4" NPT	2
3470-0402	Adapter Male Side Female 1" NPT	2
3470-0403	Male End Cap	3
3470-0303	Female End Cap	3

HYPRO® SPRAYER CONTROL VALVES



BOLTS, KITS AND MOUNTING BRACKETS

Part Number	Description
3470-0601	1 Section stainless steel
3470-0605	2 Section stainless steel
3470-0603	3 Section stainless steel
3470-0602	4 Section stainless steel
3470-0604	5 Section stainless steel



FLANGED LINE STRAINER

Part Number	Description
3470-0800	Self Cleaning, 50 Mesh

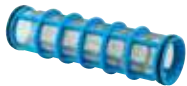

REPLACEMENT SCREENS FOR FLANGED LINE STRAINER

Part Number	Description
3470-0801	50 Mesh



CABLES

Part Number	Description
3470-0700	2 wire- 4' cable w/ gasket and screw
3470-0702	Din connector w/ gasket and screw

BALL VALVES

- ◆ Fiberglass-reinforced polypropylene body for strength and chemical resistance
- ◆ Teflon seats for smooth operation and proper sealing characteristics
- ◆ EPDM O-rings to handle most fertilizers and chemicals
- ◆ Max. operating pressure for sizes up to 1-1/4" - 232 PSI (16 bar). For 1-1/2" and 2" - 145 PSI (10 bar).



SINGLE UNION BALL VALVES - 2 WAY

NPT Part Number	BSP Part Number	Part Number	Size	Mounting Inserts	Max PSI	Max BAR
9951-2050N	9951-2050B	56454132	1/2"	None	232	16
9951-2075N	9951-2075B	56454133	3/4"	None	232	16
9951-2100N	9951-2100B	56454134	1"	None	232	16
9951-2125N	9951-2125B	56454135	1-1/4"	8 mm	145	10
9951-2150N	9951-2150B	56454136	1-1/2"	8 mm	145	10
9951-2200N	9951-2200B	56454137	2"	8 mm	145	10

Available for order through HYPRO-EU only (Cambridge, UK)



SINGLE UNION BALL VALVES - 3 WAY

NPT Part Number	BSP Part Number	Part Number	Size	Mounting Inserts	Max PSI	Max BAR
9951-3050N	9951-3050B	56454232	1/2"	None	232	16
9951-3075N	9951-3075B	56454233	3/4"	None	232	16
9951-3100N	9951-3100B	56454234	1"	None	232	16
9951-3125N	9951-3125B	56454235	1-1/4"	8 mm	145	10
9951-3150N	9951-3150B	56454236	1-1/2"	8 mm	145	10
9951-3200N	9951-3200B	56454237	2"	8 mm	145	10

Available for order through HYPRO-EU only (Cambridge, UK)



ANTI-BACKFLOW VALVES

Part Number	MBSP x MBSP	Length
5042015	1-1/4" x 1-1/4"	4.13" / 105 mm
5042016	1-1/2" x 1-1/2"	4.37" / 111 mm
5042017	2" x 2"	4.96" / 126 mm
5042019	3" x 3"	6.02" / 153 mm



CHECK VALVES

Part Number	MNPT x MNPT	Material	Cracking Pressure PSI	Cracking Pressure BAR
3320-0065	1/2" X 1/2"	Polypropylene	3	.20



SHUT-OFF VALVES

Part Number	MGHT (inlet) x MGHT	Material
3305-0112	1/2" X 1/2"	Polypropylene



GARDEN HOSE SHUT-OFF VALVE

Part Number	FGHT (inlet) x MGHT	Type	Description	Max. PSI	Max BAR
LA5	3/4" X 3/4"	1-Way	Cyclac body and ball with Buna-N seals suitable for outdoor use	75	5
LA24	3/4" X (2) 3/4"	2-Way		75	5



POLYPROPYLENE BALL VALVE

Part Number	Size	Max. PSI*	Max. BAR	Material	O-ring Material
15-14	1/4" X 1/4"	25	3.4	Polypropylene	EPDM

*Max psi for liquids compatible with polypropylene and EPDM.

BALL VALVES

SERIES 90 – PLATED BRASS BALL VALVE



Part Number	Size	Handle Type	Max PSI	Max BAR	Max. Temp	
					US Units	Metric Units
90FFB18	1/8" FNPT X 1/8" FNPT	Butterfly	300	20	212° F	100° C
90FFB14	1/4" FNPT X 1/4" FNPT	Butterfly	300	20	212° F	100° C
90FMB14	1/4" FNPT X 1/4" MNPT	Butterfly	300	20	212° F	100° C
90FFB38	3/8" FNPT X 3/8" FNPT	Butterfly	300	20	212° F	100° C
90FMB38	3/8" FNPT X 3/8" MNPT	Butterfly	300	20	212° F	100° C
90FFB12	1/2" FNPT X 1/2" FNPT	Butterfly	300	20	212° F	100° C
90FMB12	1/2" FNPT X 1/2" MNPT	Butterfly	300	20	212° F	100° C
90FFL18	1/8" FNPT X 1/8" FNPT	Lever	300	20	212° F	100° C
90FFL14	1/4" FNPT X 1/4" FNPT	Lever	300	20	212° F	100° C
90FML14	1/4" FNPT X 1/4" MNPT	Lever	300	20	212° F	100° C
90FFL38	3/8" FNPT X 3/8" FNPT	Lever	300	20	212° F	100° C
90FML38	3/8" FNPT X 3/8" MNPT	Lever	300	20	212° F	100° C
90FFL12	1/2" FNPT X 1/2" FNPT	Lever	300	20	212° F	100° C
90FML12	1/2" FNPT X 1/2" MNPT	Lever	300	20	212° F	100° C
90-HBF		Replacement nylon butterfly handle				
RI167		Replacement nylon lever handle				

FULL PORT BRASS AND 316 STAINLESS STEEL BALL VALVES



Part Number	Material	Size	Max PSI	Max Bar	Max. Temp.	
					US Units	Metric Units
171N-14	Brass	1/4" FNPT	600	41	320° F	160° C
171N-38	Brass	3/8" FNPT	600	41	320° F	160° C
171N-12	Brass	1/2" FNPT	600	41	320° F	160° C
171N-34	Brass	3/4" FNPT	600	41	320° F	160° C
171N-100	Brass	1" FNPT	600	41	320° F	160° C
171N-114	Brass	1 1/4" FNPT	600	41	320° F	160° C
171N-112	Brass	1 1/2" FNPT	600	41	320° F	160° C
171N-200	Brass	2" FNPT	600	41	320° F	160° C
78-14	316 Stainless Steel	1/4" FNPT	1000	69	320° F	160° C
78-38	316 Stainless Steel	3/8" FNPT	1000	69	320° F	160° C
78-12	316 Stainless Steel	1/2" FNPT	1000	69	320° F	160° C
78-34	316 Stainless Steel	3/4" FNPT	1000	69	320° F	160° C
78-100	316 Stainless Steel	1" FNPT	1000	69	320° F	160° C
78-114	316 Stainless Steel	1 1/4" FNPT	1000	69	320° F	160° C
78-112	316 Stainless Steel	1 1/2" FNPT	1000	69	320° F	160° C
78-200	316 Stainless Steel	2" FNPT	1000	69	320° F	160° C
78-300	316 Stainless Steel	3" FNPT	1000	69	320° F	160° C

10-32 threaded mounting holes.
Teflon seals and o-rings.

GAUGES

Dual-Scale Glycerin-Filled 2-1/2" Gauges (Stainless Steel Case)



- ◆ Movement: Brass
- ◆ Bourdon Tube: Phosphor bronze
- ◆ Pointer: Black-enameled aluminum
- ◆ Dial: White background
- ◆ Window: Acrylic
- ◆ Liquid Fill: 99.5% pure virgin Glycerin
- ◆ Connection: 1/4" NPT Brass connection
- ◆ Accuracy: ASME/ANSI B40.1 Grade B (3-2-3%)

This series is designed for use with air, gas, oil, and water or any medium not corrosive to brass or bronze. Liquid-filled gauges are recommended for reducing shock waves caused by pressure or vibration fluctuations.

ORDER INFORMATION

Part Number	Pressure Reading Range	Face Size		Stem Size	Estimated Weight Ea.	
		US Units	Metric Units		US Units	Metric Units
2640-0009	0-60 psi/4 BAR	2-1/2"	65 mm	1/4" NPT (M)	7.5 oz.	213 g
2640-0010	0-100 psi/7 BAR					
2640-0011	0-200 psi/14 BAR					
2640-0007	0-300 psi/21 BAR					
2640-0008	0-600 psi/42 BAR					
2640-0001	0-1000 psi/70 BAR					
2640-0002	0-1500 psi/105 BAR					
2640-0003	0-2000 psi/140 BAR					
2640-0004	0-3000 psi/210 BAR					
2640-0005	0-5000 psi/350 BAR					
2640-0014	0-10000 psi/700 BAR					

GAUGES

SG SERIES DRY 1-1/2", 2", 2-1/2" AND 4" GAUGES



PSI only Plastic case

This series is designed for use with air, gas, oil, and water or any medium not corrosive to brass or bronze.

- ◆ Movement: Brass
- ◆ Bourdon Tube: C Shaped in copper alloy up to 600 psi and Helical in phosphor bronze over 600 psi
- ◆ Pointer: Black-enameled aluminum
- ◆ Dial: White aluminum
- ◆ Window: Acrylic
- ◆ Connection: 1/8" NPT male standard on 1-1/2" size
1/4" NPT standard on 2", 2-1/2", & 4" sizes
- ◆ Accuracy: ASME/ANSI B40.1 Grade B (3-2-3%)

ORDER INFORMATION

Part Number	PSI Range	Dial Size	Stem Size		
SG601.58C	0-60	1-1/2"	1/8" CBM		
SG1001.58C	0-100				
SG1601.58C	0-160				
SG2001.58C	0-200				
SG602C	0-60	2"	1/4" CBM		
SG1002C	0-100				
SG1602C	0-160				
SG2002C	0-200				
SG3002C	0-300				
SG152	0-15	2"	1/4" LM		
SG302	0-30				
SG602	0-60				
SG1002	0-100				
SG1602	0-160				
SG2002	0-200				
SG3002	0-300				
SG15	0-15			2-1/2"	1/4" LM
SG30	0-30				
SG60	0-60				
SG100	0-100				
SG160	0-160				
SG200	0-200				
SG300	0-300				
SG400	0-400				
SG600	0-600				
SG1000	0-1000				
SG2000	0-2000				
SG3000	0-3000				
SG5000	0-5000				
SG604	0-60	4"	1/4" LM		
SG1004	0-100				
SG2004	0-200				

GG SERIES GLYCERIN-FILLED 2-1/2" AND 4" GAUGES



PSI only
304 Stainless Steel Case

This series is designed for use with air, gas, oil, and water or any medium not corrosive to brass or bronze. Liquid-filled gauges are recommended for reducing shock waves caused by pressure or vibration fluctuations.

- ◆ Movement: Brass
- ◆ Bourdon Tube: Phosphor bronze
- ◆ Pointer: Black-enameled aluminum
- ◆ Dial: White background
- ◆ Window: Acrylic
- ◆ Liquid Fill: 99.5% pure virgin Glycerin
- ◆ Connection: 1/4" NPT Brass connection
- ◆ Accuracy: ASME/ANSI B40.1 Grade B (3-2-3%)

ORDER INFORMATION

Part Number	PSI Range	Dial Size	Stem Size		
WGG60C	0-60	2-1/2"	1/4" CBM & U-clamp		
WGG100C	0-100				
WGG160C	0-160				
WGG200C	0-200				
WGG300C	0-300				
WGG400C	0-400				
WGG600C	0-600				
WGG1000C	0-1000				
WGG1500C	0-1500				
WGG2000C	0-2000				
WGG3000C	0-3000				
WGG5000C	0-5000				
WGG6000C	0-6000				
GG30	0-30			2-1/2"	1/4" LM
GG60	0-60				
GG100	0-100				
GG160	0-160				
GG200	0-200				
GG300	0-300				
GG400	0-400				
GG600	0-600				
GG1000	0-1000				
GG1500	0-1500				
GG2000	0-2000				
GG3000	0-3000				
GG4000	0-4000				
GG5000	0-5000				
GG6000	0-6000				
GG10000	0-10000	2-1/2"	1/4" LM		
GG15000	0-15000				
VGG30	VAC / 30 Hg	2-1/2"	1/4" LM		
VGG3030	0-30 psi / 30 Hg				
VGG3060	0-60 psi / 30 Hg				
VGG30160	0-160 psi / 30 Hg				
GG604	0-60	4"	1/4" LM		
GG1004	0-100				

GAUGES

ASG SERIES DRY 2-1/2" AND 4" GAUGES FOR AMMONIA



2-1/2" and 4" Gauges
Single Scale - PSI only
Enameled steel case

This series is designed especially for use with ammonia.

- ◆ Movement: Stainless Steel tube
- ◆ Bourdon Tube: 316 Stainless Steel
- ◆ Pointer: Black-enameled aluminum
- ◆ Dial: White background
- ◆ Window: Polycarbonate
- ◆ Connection: 1/4" NPT Standard
- ◆ Accuracy: ASME/ANSI B40.1 Grade B (3-2-3 %)

WGGSS SERIES GLYCERIN-FILLED 2-1/2" GAUGES



PSI only

This series is designed for use with air, gas, oil, and water or any medium not corrosive to stainless steel. Liquid-filled gauges are recommended for reducing shock waves caused by pressure or vibration fluctuations.

- ◆ Movement: Stainless Steel
- ◆ Bourdon Tube: 316 Stainless Steel
- ◆ Pointer: Black-enameled aluminum
- ◆ Dial: White background
- ◆ Window: Polycarbonate
- ◆ Liquid Fill: 99.5% pure virgin Glycerin
- ◆ Connection: 1/4" NPT Stainless Steel connection
2-1/2" gauges
- ◆ Accuracy: 2-1/2" - ASME/ANSI B40.1 Grade A (2-1-2 %)

ACCESSORIES



ORDER INFORMATION

Part Number	PSI Range	Dial Size	Stem Size
ASG60	0-60	2-1/2"	1/4" LM
ASG160	0-160	2-1/2"	1/4" LM
ASG400	0-400	2-1/2"	1/4" LM
ASG604	0-60	4"	1/4" LM
ASG1604	0-160	4"	1/4" LM
ASG4004	0-400	4"	1/4" LM

Replacement lens AF available.

ORDER INFORMATION

Part Number	PSI Range	Dial Size	Stem Size
WGGSS100C	0-100	2-1/2"	1/4" CBM
WGGSS400C	0-400		
WGGSS60	0-60	2-1/2"	1/4" LM
WGGSS100	0-100		
WGGSS160	0-160		
WGGSS400	0-400		
WGGSS600	0-600		
WGGSS1000	0-1000		
WGGSS3000	0-3000		
WGGSS5000	0-5000		

ORDER INFORMATION

Reference Number	Part Number	Description
1	MF1814B	Reducing Coupler 1/4" FNPT x 1/8" MNPT
2	B301AB	1/4" Gauge Dampener
3	3470-0205	Universal Isolator Kit

UNIVERSAL FLANGED CLAMPS



- ◆ Clamshell designed delivers superior durability and sealing capability through an even clamping pressure around Universal Flange joints
- ◆ GTX polymer delivers superior chemical resistance and strength
- ◆ Captured bolt and nut design allows for ease of assembly and maintenance, with 10mm socket or nut driver
- ◆ Servicable design eliminates areas prone to collecting debris and excessive corrosion

Size		Fits Series	Max. Operating Pressure		Packaging	UF Clamps w/ Stainless Steel Hardware
US Units	Metric Units		at 70°F	at 21°C		Part Number
1"	25 mm	100	150 PSI	10 BAR	1 Clamp & 1 Gasket	BG-UFC0100E-A-S
					Clamp only	UFC0100-S
1.5"	38 mm	200	150 PSI	10 BAR	1 Clamp & 1 Gasket	BG-UFC0150E-A-S
					Clamp only	UFC0150-S
2"	51 mm	220	150 PSI	10 BAR	1 Clamp & 1 Gasket	BG-UFC0200E-A-S
					Clamp only	UFC0200-S
3"	76 mm	300	125 PSI	8.6 BAR	1 Clamp & 1 Gasket	BG-UFC0300E-A-S
					Clamp only	UFC0300-S

UNIVERSAL FLANGED GASKETS



- ◆ The gasket wraparound feature provides positive alignment of the adjoining fittings and allows visual inspection to be conducted during assembly
- ◆ Provides sealing areas between fitting faces and outside diameter of flanged surfaces which increases the maximum pressure the joint can manage without leaks
- ◆ Flow can be increased by as much as 16% as the new universal flanged gasket reduces protrusion into the joint

Part Number	Size		Fits Series	Gasket Type
	US Units	Metric Units		
UFG0100E-A	1"	25 mm	100	EPDM
UFG0150E-A	1.5"	38 mm	200	EPDM
UFG0200E-A	2"	51 mm	220	EPDM
UFG0300E-A	3"	76 mm	300	EPDM

UNIVERSAL FLANGE FITTINGS AND VALVES

UNIVERSAL FLANGE SIZE REFERENCE

Hypro Part Number Series	UF100	Not Available	UF200	UF300
UF Series	100	200	220	300
US Units	1"	1.5"	2"	3"
Metric Units	25 mm	38 mm	51 mm	76 mm
Maximum Operating Pressure @ 70° F (21° C)	150 PSI (10 BAR)	N/A	150 PSI (10 BAR)	125 PSI (8.5 BAR)

UNIVERSAL FLANGE COUPLINGS

Part Number	Size	Fit Series	Description	Max. Operating Pressure	
				at 70°F	at 21°C
UF100	1"	100	Coupling, Flange	150 PSI	10 BAR
UF200	2"	220	Coupling, Flange	150 PSI	10 BAR
UF300	3"	300	Coupling, Flange	125 PSI	8.6 BAR

UNIVERSAL FLANGE ELBOWS

Part Number	Size	Fit Series	Description	Max. Operating Pressure	
				at 70°F	at 21°C
UF100L	1"	100	Elbow, Flange	150 PSI	10 BAR
UF200L	2"	220	Elbow, Flange	150 PSI	10 BAR
UF300L	3"	300	Elbow, Flange	125 PSI	8.6 BAR

UNIVERSAL FLANGE TEES

Part Number	Size	Fit Series	Description	Max. Operating Pressure	
				at 70°F	at 21°C
UF100T	1"	100	Tee, Flange	150 PSI	10 BAR
UF200T	2"	220	Tee, Flange	150 PSI	10 BAR
UF300T	3"	300	Tee, Flange	125 PSI	8.6 BAR



UNIVERSAL FLANGE FITTINGS AND VALVES



UNIVERSAL FLANGE CROSSES

Part Number	Size	Fit Series	Description	Max. Operating Pressure	
				at 70°F	at 21°C
UF100X	1"	100	Cross, Flange	150 PSI	10 BAR
UF200X	2"	220	Cross, Flange	150 PSI	10 BAR
UF300X	3"	300	Cross, Flange	125 PSI	8.6 BAR



UNIVERSAL FLANGE REDUCING COUPLINGS

Part Number	Size	Fit Series	Description	Max. Operating Pressure	
				at 70°F	at 21°C
UF200-RC100	2" x 1"	220 x100	Reducing Coupling Flange x Flange	150 PSI	10 BAR
UF300-RC200	3" x 2"	300 x220	Reducing Coupling Flange x Flange	125 PSI	8.6 BAR



UNIVERSAL FLANGE X HOSE BARBS

Part Number	Size (UF X HB)	Fit Series	Description	Max. Operating Pressure	
				at 70°F	at 21°C
UF100-HB075	1" x 3/4"	100	Flange x HB	150 PSI	10 BAR
UF100-HB100	1" x 1"	100	Flange x HB	150 PSI	10 BAR
UF100-HB125	1" x 1-1/4"	100	Flange x HB	150 PSI	10 BAR
UF200-HB150	2" x 1-1/2"	220	Flange x HB	150 PSI	10 BAR
UF200-HB200	2" x 2"	220	Flange x HB	150 PSI	10 BAR
UF300-HB200	3" x 2"	300	Flange x HB	125 PSI	8.6 BAR
UF300-HB300	3" x 3"	300	Flange x HB	125 PSI	8.6 BAR



UNIVERSAL FLANGE ELBOW X HOSE BARBS

Part Number	Size (UF X HB)	Fit Series	Description	Max. Operating Pressure	
				at 70°F	at 21°C
UF100L-HB075	1" x 3/4"	100	Elbow, Flange x HB	150 PSI	10 BAR
UF100L-HB100	1" x 1"	100	Elbow, Flange x HB	150 PSI	10 BAR
UF100L-HB125	1" x 1-1/4"	100	Elbow, Flange x HB	150 PSI	10 BAR
UF150L-HB125	1" x 1.25"	150	Elbow, Flange x HB	150 PSI	10 BAR
UF200L-HB150	2" x 1-1/2"	220	Elbow, Flange x HB	150 PSI	10 BAR
UF200L-HB200	2" x 2"	220	Elbow, Flange x HB	150 PSI	10 BAR
UF300L-HB200	3" x 2"	300	Elbow, Flange x HB	125 PSI	8.6 BAR
UF300L-HB300	3" x 3"	300	Elbow, Flange x HB	125 PSI	8.6 BAR



UNIVERSAL FLANGE X HOSE BARB TEE

Part Number	Size (UF x FNPT)	Fit Series	Description	Max. Operating Pressure	
				at 70°F	at 21°C
UF100-HBT100	1" x 1"	100	Flange x HBT	150 PSI	10 BAR



UNIVERSAL FLANGE X MALE PIPE THREAD

Part Number	Size (UF X MNPT)	Fit Series	Description	Max. Operating Pressure	
				at 70°F	at 21°C
UF100-MN075	1" x 3/4"	100	Flange x MNPT	150 PSI	10 BAR
UF100-MN100	1" x 1"	100	Flange x MNPT	150 PSI	10 BAR
UF100-MN125	1" x 1-1/4"	100	Flange x MNPT	150 PSI	10 BAR
UF200-MN200	2" x 2"	220	Flange x MNPT	150 PSI	10 BAR
UF300-MN300	3" x 3"	300	Flange x MNPT	125 PSI	8.6 BAR



UNIVERSAL FLANGE X FEMALE PIPE THREAD

Part Number	Size (UF x FNPT)	Fit Series	Description	Max. Operating Pressure	
				at 70°F	at 21°C
UF100-FN100	1" x 1"	100	Flange x FNPT	150 PSI	10 BAR
UF200-FN200	2" x 2"	220	Flange x FNPT	150 PSI	10 BAR



UNIVERSAL FLANGE X MALE CAMLOCK ADAPTER

Part Number	Size	Fit Series	Description	Max. Operating Pressure	
				at 70°F	at 21°C
UF200-MA200	2" x 2"	220	Flange x Male Coupler Camlock	150 PSI	10 BAR
UF300-MA300	3" x 3"	300	Flange x Male Coupler Camlock	125 PSI	8.6 BAR



UNIVERSAL FLANGE PLUG X FLANGE

Part Number	Size	Fit Series	Description	Max. Operating Pressure	
				at 70°F	at 21°C
UF100P	1" x 1"	100	Plug, Flange	150 PSI	10 BAR
UF200P	2" x 2"	220	Plug, Flange	150 PSI	10 BAR
UF300P	3" x 3"	300	Plug, Flange	125 PSI	8.6 BAR
UF100-FN025P	1" w/ 1/4" FPT	100	Plug, Flange w/FPT	150 PSI	10 BAR



UNIVERSAL FLANGE BOLTED BALL VALVES

Part Number	Size	Fit Series	Description	Max. Operating Pressure	
				at 70°F	at 21°C
9951-2100UF	1"	100	Bolted Ball Valve with flange connections	150 PSI	10 BAR
9951-2200UF	2"	220	Bolted Ball Valve with flange connections	150 PSI	10 BAR
9951-2300UF	3"	300	Bolted Ball Valve with flange connections	125 PSI	8.6 BAR

HOSE BARB WITH FLY NUT & O-RING

STRAIGHT HOSE BARB WITH FLY NUT AND O-RING



Part Number	O-Ring Groove x Hose Barb	
	US Units	Metric Units
FNAS-1212	1/2 inch x 1/2 inch	13 mm x 13 mm
FNAS-3412	3/4 inch x 1/2 inch	19 mm x 13 mm
FNAS-3458	3/4 inch x 5/8 inch	19 mm x 16 mm
FNAS-3434	3/4 inch x 3/4 inch	19 mm x 19 mm
FNAS-10012	1 inch x 1/2 inch	25 mm x 13 mm
FNAS-10034	1 inch x 3/4 inch	25 mm x 19 mm
FNAS-100100	1 inch x 1 inch	25 mm x 25 mm
FNAS-114100	1-1/4 inch x 1 inch	32 mm x 25 mm
FNAS-114114	1-1/4 inch x 1-1/4 inch	32 mm x 32 mm
FNAS-112100	1-1/2 inch x 1 inch	38 mm x 25 mm
FNAS-112114	1-1/2 inch x 1-1/4 inch	38 mm x 32 mm
FNAS-112112	1-1/2 inch x 1-1/2 inch	38 mm x 38 mm
FNAS-200200	2 inch x 2 inch	50 mm x 50 mm

ELBOW HOSE BARB WITH FLY NUT AND O-RING



Part Number	O-Ring Groove x Hose Barb	
	US Units	Metric Units
FNAE-3412	3/4 inch x 1/2 inch	19 mm x 13 mm
FNAE-3458	3/4 inch x 5/8 inch	19 mm x 16 mm
FNAE-3434	3/4 inch x 3/4 inch	19 mm x 19 mm
FNAE-10034	1 inch x 3/4 inch	25 mm x 19 mm
FNAE-100100	1 inch x 1 inch	25 mm x 25 mm
FNAE-114100	1-1/4 inch x 1 inch	32 mm x 25 mm
FNAE-114114	1-1/4 inch x 1-1/4 inch	32 mm x 32 mm
FNAE-112100	1-1/2 inch x 1 inch	38 mm x 25 mm
FNAE-112114	1-1/2 inch x 1-1/4 inch	38 mm x 32 mm
FNAE-112112	1-1/2 inch x 1-1/2 inch	38 mm x 38 mm
FNAE-200200	2 inch x 2 inch	50 mm x 50 mm

All assemblies include same size fly nut and o-ring.

BLANKING CAPS



Part Number	CAP-BPS Threads
2102030	3/4"
FNCAP-100	1"

FITTINGS - CAM LOCKS

Stainless Steel and Polypropylene Cam Lock Couplings

A. MALE ADAPTER / FEMALE THREAD



A

Stainless Steel	Coupling Size	Thread Size	NPT Poly	BSP Poly	BSP Poly
A-750SS	3/4 inch	3/4 inch	9950-075NA	9950-075BA	02075A34
A-100SS	1 inch	1 inch	9950-100NA	9950-100BA	02100A10
-	1-1/4 inch	1-1/4 inch	9950-125NA	9950-125BA	02125A54
A-150SS	1-1/2 inch	1-1/2 inch	9950-150NA	9950-150BA	02150A64
A-200SS	2 inch	2 inch	9950-200NA	9950-200BA	02200A20
A-300SS	3 inch	3 inch	9950-300NA	9950-300BA	02300A30

Available for order through HYPRO-EU only (Cambridge, UK)



A

B. FEMALE COUPLER / MALE THREAD



B

Stainless Steel	Coupling Size	Thread Size	NPT Poly	BSP Poly	BSP Poly
B-750SS	3/4 inch	3/4 inch	9950-075NB	9950-075BB	02075B34
B-100SS	1 inch	1 inch	9950-100NB	9950-100BB	02100B10
-	1-1/4 inch	1-1/4 inch	9950-125NB	9950-125BB	02125B54
B-150SS	1-1/2 inch	1-1/2 inch	9950-150NB	9950-150BB	02150B64
B-200SS	2 inch	2 inch	9950-200NB	9950-200BB	02200B20
B-300SS	3 inch	3 inch	9950-300NB	9950-300BB	02300B30

Available for order through HYPRO-EU only (Cambridge, UK)



B

C. FEMALE COUPLER / HOSE FITTING



C

Stainless Steel	Coupling Size	Barb Size	Poly	Poly
C-750SS	3/4 inch	3/4 inch	9950-075C	02075C34
C-100SS	1 inch	1 inch	9950-100C	02100C10
-	1-1/4 inch	1-1/4 inch	9950-125C	02125C54
C-150SS	1-1/2 inch	1-1/2 inch	9950-150C	02150C64
C-200SS	2 inch	2 inch	9950-200C	02200C20
C-300SS	3 inch	3 inch	9950-300C	02300C30

Available for order through HYPRO-EU only (Cambridge, UK)



C

FITTINGS - CAM LOCKS

Stainless Steel and Polypropylene Cam Lock Couplings

D. FEMALE COUPLER / FEMALE THREAD

Stainless Steel	Coupling Size	Thread Size	Poly	BSP Poly	BSP Poly
-	3/4 inch	1/2 inch	18103D2N	-----	02050D12
D-750SS	3/4 inch	3/4 inch	9950-075ND	9950-075BD	02075D34
D-100SS	1 inch	1 inch	9950-100ND	9950-100BD	02100D10
-	1-1/4 inch	1-1/4 inch	9950-125ND	9950-125BD	02125D54
D-150SS	1-1/2 inch	1-1/2 inch	9950-150ND	9950-150BD	02150D64
D-200SS	2 inch	2 inch	9950-200ND	9950-200BD	02200D20
D-300SS	3 inch	3 inch	9950-300ND	9950-300BD	02300D30



D



D

Available for order through HYPRO-EU only (Cambridge, UK)

E. MALE ADAPTER / HOSE FITTING

Stainless Steel	Coupling Size	Hose Size	Poly	Poly
-	3/4 inch	1/2 inch	18103E2	02050E12
E-750SS	3/4 inch	3/4 inch	9950-075E	02075E34
E-100SS	1 inch	1 inch	9950-100E	02100E10
-	1-1/4 inch	1-1/4 inch	9950-125E	02125E54
E-150SS	1-1/2 inch	1-1/2 inch	9950-150E	02150E64
E-200SS	2 inch	2 inch	9950-200E	02200E20
E-300SS	3 inch	3 inch	9950-300E	02300E30



E



E

Available for order through HYPRO-EU only (Cambridge, UK)

F. MALE ADAPTER / MALE THREAD

Stainless Steel	Coupling Size	Thread Size	Poly	BSP Poly	BSP Poly
-	3/4 inch	1/2 inch	18103F2N	-----	02050F12
F-750SS	3/4 inch	3/4 inch	9950-075NF	9950-075BF	02075F34
F-100SS	1 inch	1 inch	9950-100NF	9950-100BF	02100F10
-	1-1/4 inch	1-1/4 inch	9950-125NF	9950-125BF	02125F54
F-150SS	1-1/2 inch	1-1/2 inch	9950-150NF	9950-150BF	02150F64
F-200SS	2 inch	2 inch	9950-200NF	9950-200BF	02200F20
F-300SS	3 inch	3 inch	9950-300NF	9950-300BF	02300F30



F



F

Available for order through HYPRO-EU only (Cambridge, UK)

G. PLUG

Stainless Steel	Coupling Size	Poly	Poly
DP-750SS	3/4 inch	9950-075G	02075G34
DP-100SS	1 inch	9950-100G	02100G10
-	1-1/4 inch	9950-125G	-
DP-150SS	1-1/2 inch	9950-150G	02150G64
DP-200SS	2 inch	9950-200G	02200G20
DP-300SS	3 inch	9950-300G	02300G30



G



G

Available for order through HYPRO-EU only (Cambridge, UK)

H. CAP

Stainless Steel	Coupling Size	Poly	Poly
DC-750SS	3/4 inch	9950-075H	02075P34
DC-100SS	1 inch	9950-100H	02100P10
-	1-1/4 inch	9950-125H	-
DC-150SS	1-1/2 inch	9950-150H	02150P64
DC-200SS	2 inch	9950-200H	02200P20
DC-300SS	3 inch	9950-300H	02300P30



H



H

Available for order through HYPRO-EU only (Cambridge, UK)

CAM LOCK REPLACEMENT GASKET

Size	EPDM Part Number	EPDM Part Number	Viton Part Number
3/4 inch	18103B-050	02-050G	18123B-050
1 inch	18104B-050	02-100G	18124B-050
1-1/4 inch	18105B-050	-	18125B-050
1-1/2 inch	18106B-050	02-150G	18126B-050
2 inch	18107B-050	02-200G	18127B-050
3 inch	18109B-050	02-300G	18129B-050



Available for order through HYPRO-EU only (Cambridge, UK)

NYLON® AND POLYPROPYLENE FITTINGS

Supplemental Technical Information on Nylon and Polypropylene Fittings



NYLON FITTINGS

WORKING PRESSURE:

up to 150 psi (10 bar) at ambient temperatures.

At very low pressures, temperatures can approach 175°F (80° C) with no degradation in the performance of the nylon fitting.

RECOMMENDED:

- ◆ For physical or structural strength
- ◆ For broad temperature range
- ◆ With PTFE tape

NOT RECOMMENDED:

- ◆ Acid-based fertilizers/defoliants
- ◆ Prolonged sunlight/UV exposure

POLYPROPYLENE FITTINGS

WORKING PRESSURE:

up to 150 psi (10 bar) at ambient temperatures

As with all thermoplastics, an increase in working temperature is accompanied by a decrease in acceptable operating pressure.

At 140°F (60°C), the working pressure limit is 90 psi (6 bar).

RECOMMENDED:

- ◆ Hand tight, plus 1 turn
- ◆ For normal ag growing season conditions
- ◆ For acid resistance
- ◆ For Sunlight/UV resistance
- ◆ For cosmetic appearance

NOT RECOMMENDED:

- ◆ Impact wrench, other over tightening
- ◆ For temperature extremes
- ◆ With PTFE tape
- ◆ For toluene or xylene-based compounds

CHEMICAL RESISTANCE

Chemical	Nylon	Polypropylene
Most Agricultural Chemicals	Green	Green
Acidic Fertilizers	Red	Green
Ammonium Compounds	Green	Green
Aromatic Hydrocarbons	Green	Red
Bromine	Red	Red
Calcium Carbonate	Green	Green
Carbon Tetrachloride	Yellow	Red
Chlorine	Red	Yellow
Detergents	Green	Green
Diesel Fuel	Green	Red
Ethanol	Green	Green
Fluorine	Red	Red
Gasoline	Green	Red
Hexane	Green	Red
Hydrochloric Acid	Red	Green
Iodine	Red	Yellow
Kerosene	Green	Red

Chemical	Nylon	Polypropylene
Magnesium Sulfate	Green	Green
Nitric Acid	Red	Yellow
Oxalic Acid	Red	Green
Phosphoric Acid	Green	Green
Propionic Acid	Green	Green
Most Sodium Compounds	Green	Green
Sodium Hypochlorite	Red	Yellow
Sulfuric Acid	Red	Yellow
Toluene	Green	Red
Trichloroethylene	Green	Red
Xylene	Green	Red
Zinc Sulfate	Green	Green

Key	
Chemical Resistance:	Green
Consult Factory:	Yellow
Not Recommended:	Red

Nylon® is a registered trademark of Dupont Co. Hypro® is a registered trademark of Pentair.

FITTINGS - PLASTIC

MALE MNPT PIPE THREAD BY HOSE BARB

Std Pack	MPT X HB	Nylon	Poly
25	1/8 inch X 3/16 inch (4,7 mm)	A18316	3A18316
25	1/8 inch X 1/4 inch (6,4 mm)	A1814	3A1814
25	1/8 inch X 5/16 inch (8 mm)	A18516	-
25	1/8 inch X 3/8 inch (10 mm)	A1838	3A1838
25	1/4 inch X 3/16 inch (4,7 mm)	A14316	-
25	1/4 inch X 1/4 inch (6,4 mm)	A14	3A14
25	1/4 inch X 5/16 inch (8 mm)	A14516	-
25	1/4 inch X 3/8 inch (8 mm)	A1438	3A1438
25	1/4 inch X 1/2 inch (13 mm)	A1412	3A1412
25	3/8 inch X 1/4 inch (6,4 mm)	A3814	3A3814
25	3/8 inch X 5/16 inch (8 mm)	A38516	3A38516
25	3/8 inch X 3/8 inch (10 mm)	A38	3A38
25	3/8 inch X 1/2 inch (13 mm)	A3812	3A3812
25	3/8 inch X 5/8 inch (16 mm)	A3858	3A3858
25	1/2 inch X 3/16 inch (4,7 mm)	A12316	-
25	1/2 inch X 1/4 inch (6,4 mm)	A1214	3A1214
25	1/2 inch X 3/8 inch (10 mm)	A1238	3A1238
25	1/2 inch X 1/2 inch (13 mm)	A12	3A12
25	1/2 inch X 5/8 inch (16 mm)	A1258	3A1258
25	1/2 inch X 3/4 inch (19 mm)	A1234	3A1234
25	1/2 inch X 1 inch (25 mm)	A12100	-
25	3/4 inch X 1/4 inch (6,4 mm)	A3414	3A3414
25	3/4 inch X 3/8 inch (10 mm)	A3438	3A3438
25	3/4 inch X 1/2 inch (13 mm)	A3412	3A3412
25	3/4 inch X 5/8 inch (16 mm)	A3458	3A3458
25	3/4 inch X 3/4 inch (19 mm)	A34	3A34
25	3/4 inch X 1 inch (25 mm)	A34100	3A34100
25	1 inch X 3/4 inch (19 mm)	A10034	3A10034
25	1 inch X 1 inch (25 mm)	A100	3A100
25	1 inch X 1 1/4 inch (32 mm)	A100114	3A100114
1	1-1/4 inch X 3/4 inch (19 mm)	A11434	3A11434
1	1-1/4 inch X 1 inch (25 mm)	A114100	3A114100
1	1-1/4 inch X 1-1/4 inch (32 mm)	A114	3A114
1	1-1/4 inch X 1-1/2 inch (38 mm)	A114112	3A114112
1	1-1/2 inch X 1-1/4 inch (32 mm)	A112114	3A112114
1	1-1/2 inch X 1-1/2 inch (38 mm)	A112	3A112
1	2 inch X 2 inch (50 mm)	A200	3A200
1	3 inch X 3 inch (76mm)	-	3A300

Add Prefix "BG" for 1 part per retail bag.



ELBOWS: MALE PIPE THREAD BY HOSE BARB

Std Pack	MPT X HB	Nylon	Poly
25	1/8 inch X 3/16 inch (4,7 mm)	EL18316	-
25	1/8 inch X 1/4 inch (6,4 mm)	EL1814	3EL1814
25	1/8 inch X 5/16 inch (8 mm)	EL18516	-
25	1/8 inch X 3/8 inch (10 mm)	EL1838	3EL1838
25	1/4 inch X 3/16 inch (4,7 mm)	-	3EL14316
25	1/4 inch X 1/4 inch (6,4 mm)	EL14	3EL14
25	1/4 inch X 5/16 inch (8 mm)	EL14516	-
25	1/4 inch X 3/8 inch (10 mm)	EL1438	3EL1438
25	1/4 inch X 1/2 inch (13 mm)	EL1412	3EL1412
25	1/4 inch X 5/8 inch (8 mm)	EL1458	-
25	3/8 inch X 1/4 inch (6,4 mm)	EL3814	3EL3814
25	3/8 inch X 5/16 inch (8 mm)	EL38516	-
25	3/8 inch X 3/8 inch (10 mm)	EL38	3EL38
25	3/8 inch X 1/2 inch (13 mm)	EL3812	3EL3812
25	3/8 inch X 5/8 inch (16 mm)	EL3858	3EL3858
25	1/2 inch X 1/4 inch (6,4 mm)	EL1214	3EL1214
25	1/2 inch X 3/8 inch (10 mm)	EL1238	3EL1238
25	1/2 inch X 1/2 inch (13 mm)	EL12	3EL12
25	1/2 inch X 5/8 inch (16 mm)	EL1258	3EL1258
25	1/2 inch X 3/4 inch (19 mm)	EL1234	3EL1234
25	1/2 inch X 1 inch (25 mm)	EL12100	-
25	3/4 inch X 1/4 inch (6,4 mm)	EL3414	3EL3414
25	3/4 inch X 3/8 inch (10 mm)	EL3438	3EL3438
25	3/4 inch X 1/2 inch (13 mm)	EL3412	3EL3412
25	3/4 inch X 5/8 inch (16 mm)	EL3458	3EL3458
25	3/4 inch X 3/4 inch (19 mm)	EL34	3EL34
25	3/4 inch X 1 inch (25 mm)	EL34100	3EL34100
25	1 inch X 1/2 inch (13 mm)	EL10012	3EL10012
25	1 inch X 3/4 inch (19 mm)	EL10034	3EL10034
25	1 inch X 1 inch (25 mm)	EL100	3EL100
1	1 inch X 1 1/4 inch (32 mm)	-	3EL100114
1	1-1/4 inch X 3/4 inch (19 mm)	EL11434	3EL11434
1	1-1/4 inch X 1 inch (25 mm)	EL114100	3EL114100
1	1-1/4 inch X 1-1/4 inch (32 mm)	EL114	3EL114
1	1-1/4 inch X 1-1/2 inch (38 mm)	EL114112	3EL114112
1	1-1/2 inch X 1-1/4 inch (32 mm)	EL112114	3EL112114
1	1-1/2 inch X 1-1/2 inch (38 mm)	EL112	3EL112
1	2 inch X 2 inch (50 mm)	EL200	3EL200
1	3 inch X 3 inch (76mm)	-	3EL300

Add Prefix "BG" for 1 part per retail bag.

FEMALE PIPE THREAD BY HOSE BARB

Std Pack	FPT X HB	Nylon	Poly
25	1/4 inch X 1/4 inch (6,4 mm)	AF14	3AF14
25	1/4 inch X 3/8 inch (10 mm)	AF1438	3AF1438
25	3/8 inch X 1/4 inch (6,4 mm)	AF3814	3AF3814
25	3/8 inch X 3/8 inch (10 mm)	AF38	3AF38
25	3/8 inch X 1/2 inch (13 mm)	AF3812	3AF3812
25	1/2 inch X 1/4 inch (6,4 mm)	AF1214	3AF1214
25	1/2 inch X 3/8 inch (10 mm)	AF1238	3AF1238
25	1/2 inch X 1/2 inch (13 mm)	AF12	3AF12
25	1/2 inch X 5/8 inch (16 mm)	AF1258	3AF1258
25	1/2 inch X 3/4 inch (19 mm)	AF1234	3AF1234
25	3/4 inch X 3/8 inch (10 mm)	AF3438	3AF3438
25	3/4 inch X 1/2 inch (13 mm)	AF3412	3AF3412
25	3/4 inch X 5/8 inch (16 mm)	-	3AF3458
25	3/4 inch X 3/4 inch (19 mm)	AF34	3AF34



ELBOWS: FEMALE PIPE THREAD BY HOSE BARB

Std Pack	FPT X HB	Nylon	Poly
25	1/4 inch X 3/16 inch (4,7 mm)	-	3EL14316F
25	1/4 inch X 1/4 inch (6,4 mm)	EL14F	3EL14F
25	1/4 inch X 3/8 inch (10 mm)	EL1438F	3EL1438F
25	3/8 inch X 1/4 inch (6,4 mm)	EL3814F	3EL3814F
25	3/8 inch X 3/8 inch (10 mm)	EL38F	3EL38F
25	3/8 inch X 1/2 inch (13 mm)	EL3812F	3EL3812F
25	1/2" inch X 1/2 inch (13mm)	-	3EL12F
25	1/2 inch X 5/8 inch (16 mm)	EL1258F	3EL1258F
25	1/2 inch X 3/4 inch (19 mm)	EL1234F	3EL1234F
25	3/4 inch X 1/2 inch (13 mm)	EL3412F	3EL3412F
25	3/4 inch X 5/8 inch (16 mm)	EL3458F	3EL3458F
25	3/4 inch X 3/4 inch (19 mm)	EL34F	3EL34F

STREET ELBOWS: FEMALE PIPE THREAD BY MALE PIPE THREAD

Std Pack	FPT X MPT	Nylon	Poly
25	1/4 inch X 1/4 inch	SE14	3SE14
25	3/8 inch X 3/8 inch	SE38	3SE38
25	1/2 inch X 1/2 inch	SE12	3SE12
25	3/4 inch X 3/4 inch	SE34	3SE34
10	1 inch X 1 inch	SE100	3SE100
1	1-1/4 inch X 1 1/4 inch	SE114	3SE114
1	1-1/2 inch X 1 1/2 inch	SE112	3SE112
1	2 inch X 2 inch	SE200	3SE200

Add Prefix "BG" for 1 part per retail bag.
Add Prefix "5BG" for 5 parts per retail bag.



STREET ELBOWS - 45°



Std Pack	MPT X FPT	Nylon	Poly
25	3/4 inch X 3/4 inch	SE3445	3SE3445
10	1/4 inch X 1/4 inch	SE1445	-

ELBOWS: FEMALE PIPE THREAD - 90°



Std Pack	FPT X FPT	Nylon	Poly
25	1/2 inch X 1/2 inch	LL12	3LL12
10	3/4 inch X 3/4 inch	LL34	3LL34
1	1 inch X 1 inch	LL100	3LL100
1	1-1/4 inch X 1 1/4 inch	LL114	3LL114
1	1-1/2 inch X 1 1/2 inch	LL112	3LL112
1	2 inch X 2 inch	LL200	3LL200



TEES: FEMALE PIPE THREAD



Std Pack	FPT X FPT X FPT	Nylon	Poly
25	1/4 inch	TT14	3TT14
10	1/2 inch	TT12	3TT12
10	3/4 inch	TT34	3TT34
1	1 inch	TT100	3TT100
1	1-1/4 inch	TT114	3TT114
1	1-1/2 inch	TT112	3TT112
1	2 inch	TT200	3TT200



TEES: FEMALE PIPE THREAD WITH 1/4 INCH GAUGE PORT



Std Pack	FPT X FPT X FPT	Nylon	Poly
25	1/2 inch	GTT1214	3GTT1214
1	3/4 inch	GTT3414	3GTT3414

Add Prefix "BG" for 1 part per retail bag.



REDUCER BUSHINGS



Std Pack	MPT X FPT	Nylon	Poly
25	1/4 inch X 1/8 inch	-	3RB1418
25	3/8 inch X 1/8 inch	RB3818	3RB3818
25	3/8 inch X 1/4 inch	RB3814	3RB3814
25	1/2 inch X 1/8 inch	RB1218	3RB1218
25	1/2 inch X 1/4 inch	RB1214	3RB1214
25	1/2 inch X 3/8 inch	RB1238	3RB1238
25	3/4 inch X 1/8 inch	RB3418	3RB3418
25	3/4 inch X 1/4 inch	RB3414	3RB3414
25	3/4 inch X 3/8 inch	RB3438	3RB3438
25	3/4 inch X 1/2 inch	RB3412	3RB3412
25	1 inch X 1/2 inch	RB10012	3RB10012
25	1 inch X 3/4 inch	RB10034	3RB10034
1	1-1/4 inch X 3/4 inch	RB11434	3RB11434
1	1-1/4 inch X 1 inch	RB114100	3RB114100
1	1-1/2 inch X 3/4 inch	RB11234	3RB11234
1	1-1/2 inch X 1 inch	RB112100	3RB112100
1	1-1/2 inch X 1-1/4 inch	RB112114	3RB112114
1	2 inch X 3/4 inch	RB20034	3RB20034
1	2 inch X 1 inch	RB200100	3RB200100
1	2 inch X 1-1/4 inch	RB200114	3RB200114
1	2 inch X 1-1/2 inch	RB200112	3RB200112
1	3 inch X 2 inch	RB300200	3RB300200

Add Prefix "BG" for 1 part per retail bag.
Add Prefix "5BG" for 5 parts per retail bag.



NIPPLES: MALE PIPE THREAD BY MALE PIPE THREAD

Std Pack	MPT X MPT	Nylon	Poly
25	1/8" X 1/8"	M18	3M18
25	1/4" X 1/4"	M14	3M14
25	3/8" X 3/8"	M38	3M38
25	1/2" X 1/2"	M12	3M12
25	3/4" X 3/4"	M34	3M34
25	1" X 1"	M100	3M100
1	1-1/4" X 1-1/4"	M114	3M114
1	1-1/2" X 1-1/2"	M112	3M112
1	2" X 2"	M200	3M200
25	1/4" X 1/8"	M1418	3M1418
25	3/8" X 1/8"	M3818	3M3818
25	3/8" X 1/4"	M3814	3M3814
25	1/2" X 1/8"	M1218	-
25	1/2" X 1/4"	M1214	3M1214
25	1/2" X 3/8"	M1238	3M1238
25	3/4" X 3/8"	M3438	3M3438
25	3/4" X 1/2"	M3412	3M3412
1	1" X 3/4"	-	3M10034

FEMALE COUPLER

Std Pack	FPT X FPT	Nylon	Poly
25	1/2" X 1/2"	FC12	3FC12
25	3/4" X 3/4"	FC34	3FC34
25	1" X 1"	FC100	3FC100
1	1-1/4" X 1-1/4"	FC114	3FC114
1	1-1/2" X 1-1/2"	FC112	3FC112
1	2" X 2"	FC200	3FC200

HEX PLUG WITH MALE PIPE THREAD

Std Pack	MPT	Nylon	Poly
25	1/8"	F18	3F18
25	1/4"	F14	3F14
25	3/8"	F38	3F38
25	1/2"	F12	3F12
25	3/4"	F34	3F34
25	1"	F100	3F100
1	1-1/4"	F114	3F114
1	1-1/2"	F112	3F112
1	2"	F200	3F200

ELBOW: HOSE BARB FITTINGS

Std Pack	HB X HB		Nylon	Poly
	US Units	Metric Units		
25	1/4" X 1/4"	6,4 x 6,4 mm	EL14HB	3EL14HB
25	3/8" X 1/4"	10 x 6,4 mm	EL3814HB	3EL3814HB
25	3/8" X 3/8"	10 x 10 mm	EL38HB	3EL38HB
25	1/2" X 1/4"	13 x 6,4 mm	EL1214HB	3EL1214HB
25	1/2" X 3/8"	13 x 10 mm	EL1238HB	3EL1238HB
25	1/2" X 1/2"	13 x 13 mm	EL12HB	3EL12HB
25	5/8" X 5/8"	16 x 16 mm	EL58HB	3EL58HB
25	3/4" X 5/8"	19 x 16 mm	EL3458HB	3EL3458HB
25	3/4" X 3/4"	19 x 19 mm	EL34HB	3EL34HB
25	1" X 1"	25 x 25 mm	EL100HB	-
1	1-1/4" X 1-1/4"	32 x 32 mm	EL114HB	3EL114HB
1	1-1/2" X 1-1/2"	38 x 38 mm	EL112HB	3EL112HB
1	2" X 2"	50 x 50 mm	EL200HB	3EL200HB

HOSE MENDER

Std Pack	HB X HB		Nylon	Poly
	US Units	Metric Units		
25	1/8" x 1/8"	3,2 x 3,2 mm	HM18*	-
25	1/4" x 3/16"	6,4 x 4,7 mm	HM14316*	-
25	1/4" x 1/4"	6,4 x 6,4 mm	SHM14	3SHM14
25	1/4" x 1/4"	6,4 x 6,4 mm	HM14*	3HM14*
25	5/16" x 5/16"	8 x 8 mm	HM516*	3HM516*
25	3/8" x 1/4"	10 x 6,4 mm	HM3814*	3HM3814*
25	3/8" x 3/8"	10 x 10 mm	SHM38	3SHM38
25	1/2" x 1/4"	13 x 6,4 mm	HM1214*	3HM1214*
25	1/2" x 3/8"	13 x 10 mm	SHM1238	3SHM1238
25	1/2" x 3/8"	13 x 10 mm	HM1238*	3HM1238*
25	1/2" x 1/2"	13 x 13 mm	SHM12	3SHM12
25	1/2" x 5/8"	13 x 16 mm	SHM1258	3SHM1258
25	5/8" x 3/8"	16 x 10 mm	HM5838*	3HM5838*
25	5/8" x 5/8"	16 x 16 mm	SHM58	3SHM58
25	5/8" x 5/8"	16 x 16 mm	HM58*	-
25	3/4" x 3/4"	19 x 19 mm	SHM34	3SHM34
25	1" x 1"	25 x 25 mm	SHM100	3SHM100
1	1-1/4" x 1-1/4"	32 x 32 mm	SHM114	3SHM114
1	1-1/2" x 1-1/2"	38 x 38 mm	SHM112	3SHM112
1	2" x 2"	50 x 50 mm	SHM200	3SHM200

*No centre stop as pictured.



TEES: HOSE BARB BY FEMALE PIPE THREAD

Std Pack	FPT X HB (1 x 2 & 3)	Nylon	Poly
25	3/4" X 3/4" (19 mm)	T34F	3T34F

MALE GARDEN HOSE THREAD BY HOSE BARB

Std Pack	MGHT X HB	Nylon	Poly
25	3/4" X 1/4" (6.4 mm)	D3414	-
25	3/4" X 3/8" (10 mm)	D3438	3D3438
25	3/4" X 1/2" (13 mm)	D3412	3D3412
25	3/4" X 5/8" (16 mm)	D3458	3D3458
25	3/4" X 3/4" (19 mm)	D34	3D34
25	3/4" X 1" (25 mm)	D34100	-

Add Prefix "BG-" for 1 part per retail bag



ELBOWS: MALE GARDEN HOSE THREAD BY HOSE BARB

Std Pack	MGHT X HB	Nylon	Poly
25	3/4" X 1/4" (6.4 mm)	ELD3414	3ELD3414
25	3/4" X 3/8" (10 mm)	ELD3438	3ELD3438
25	3/4" X 1/2" (13 mm)	ELD3412	3ELD3412
25	3/4" X 5/8" (16 mm)	ELD3458	-
25	3/4" X 3/4" (19 mm)	ELD34	3ELD34



TEES: HOSE BARBS

Std Pack	HB X HB (1 X 2, 3)		Nylon	Poly
	US Units	Metric Units		
25	1/8" X 1/8"	3,2 x 3,2 mm	T18	-
25	1/4" X 1/4"	6,4 x 6,4 mm	T14	3T14
25	1/4" X 3/8"	6,4 x 10 mm	T1438	3T1438
25	3/8" X 3/8"	10 x 10 mm	T38	3T38
25	3/8" X 1/2"	10 x 13 mm	T3812	3T3812
25	3/8" X 5/8"	10 x 16 mm	T3858	-
25	1/2" X 3/8"	13 x 10 mm	T1238	3T1238
25	1/2" X 1/2"	13 x 13 mm	T12	3T12
25	5/8" X 5/8"	16 x 16 mm	T58	3T58
25	3/4" X 1/2"	19 x 13 mm	T3412	3T3412
25	3/4" X 3/4"	19 x 19 mm	T34	3T34
25	1" X 1"	25 x 25 mm	T100	3T100
1	1-1/4" X 1-1/4"	32 x 32 mm	T114	3T114
1	1-1/2" X 1-1/2"	38 x 38 mm	T112	3T112
1	2" X 2"	50 x 50 mm	T200	3T200



ADAPTERS: MALE GARDEN HOSE THREAD BY MALE PIPE THREAD

Std Pack	MGHT X MPT	Nylon	Poly
25	3/4" X 3/8"	E3438	3E3438
25	3/4" X 1/2"	E3412	3E3412
25	3/4" X 3/4"	E34	3E34

ADAPTER COUPLINGS: FEMALE GARDEN HOSE THREAD BY FEMALE PIPE THREAD

Std Pack	FGHT X FPT	Nylon	Poly
25	3/4" X 1/2"	J3412	3J3412



TEES: MALE PIPE THREAD BY HOSE BARBS

Std Pack	MPT X HB (1 X 2, 3)	Nylon	Poly
25	1/8" X 1/4" (6.4 mm)	T1814T	-
25	1/4" X 1/4" (6.4 mm)	T14T	3T14T
25	1/4" X 3/8" (16 mm)	T1438T	3T1438T
25	1/4" X 1/2" (13 mm)	T1412T	-
25	3/8" X 1/4" (6.4 mm)	T3814T	-
25	3/8" X 3/8" (10 mm)	T38T	3T38T
25	3/8" X 1/2" (13 mm)	T3812T	3T3812T
25	1/2" X 3/8" (10 mm)	T1238T	3T1238T
25	1/2" X 1/2" (13 mm)	T12T	3T12T
25	1/2" X 5/8" (16 mm)	T1258T	-
25	1/2" X 3/8" (19 mm)	T1234T	3T1234T
25	3/4" X 3/8" (10 mm)	-	3T3438T
25	3/4" X 1/2" (13 mm)	T3412T	3T3412T
25	3/4" X 5/8" (16 mm)	-	3T3458T
25	3/4" X 3/4" (19 mm)	T34T	3T34T
25	3/4" X 1" (25 mm)	T34100T	-



ADAPTERS: FEMALE GARDEN HOSE THREAD BY MALE PIPE THREAD

Std Pack	FGHT X MPT	Nylon	Poly
25	3/4" X 3/4"	H34	3H34

ADAPTERS: MALE GARDEN HOSE THREAD BY FEMALE PIPE THREAD

Std Pack	MGHT X FPT	Nylon	Poly
25	3/4" X 1/2"	G3412	3G3412
25	3/4" X 1/4"	G3414	3G3414
25	3/4" X 3/4"	G34	3G34





ADAPTERS: FLAT SEAT BY MALE PIPE THREAD

Std Pack	MPT	Nylon	Poly
25	1/2"	C12NPT	3C12NPT



ADAPTERS: FEMALE GARDEN HOSE THREAD BY MALE GARDEN HOSE THREAD

Std Pack	FGHT X MGHT	Nylon	Poly
25	3/4" X 3/4"	I34	3I34



FEMALE GARDEN HOSE CAP KNURLED

Std Pack	FGHT	Nylon	Poly
25	3/4"	N34	3N34



FEMALE PIPE THREAD BY HOSE BARB FITTING

Std Pack	FPT X HB	Nylon	Poly
25	1/2" X 1/2" (13 mm)	Q12	3Q12
50	1/4" X 1/4" (6,4 mm)	Q14	3Q14



FEMALE PIPE STRAIGHT SWIVEL NUT-HEX

Std Pack	FPS	Nylon	Poly
25	1"	B100	3B100



FEMALE GARDEN HOSE AND FEMALE PIPE STRAIGHT SWIVEL NUT-KNURLED

Std Pack	FGHT	FPS	Nylon	Poly
25	3/4"	-	B34	3B34
25	-	3/4"	B35	3B35



FLAT SEAT HOSE BARB

Std Pack	HB		Nylon	Poly
	US Units	Metric Units		
25	1/4"	6.4 mm	C14	3C14
25	3/8"	10 mm	C38	3C38
25	1/2"	13 mm	C12	3C12
25	5/8"	16 mm	C58	3C58
25	3/4"	19 mm	C34	3C34
25	1"	25 mm	C100	3C100



FEMALE THREAD SWIVEL HEX NUT, BARB INSERT WITH BALL SEAT

Std Pack	Size		Nylon
	US Units	Metric Units	
BARB ONLY			
50	1/4" HB	6.4 mm	NC14
50	3/8" HB	10 mm	NC38
50	1/2" HB	13 mm	NC12
NUT ONLY			
50	1/4"	13 mm	NC14N
50	3/8"	10 mm	NC38N
50	1/2"	13 mm	NC12N
50	1/2" with 1/4" HB	13 mm with 6.4 mm HB	NC1214



WASHERS

Reference #	Std Pack	OD X ID	Description	Part Number
1	100	1" X 3/4"	Black Vinyl	W406V
2	100	1" X 5/8"	S.S. Filter 50/60 Mesh	W160M
3	100	1" X 1/2"	Natural Polypropylene	W405P



ROPE WICK PARTS UNASSEMBLED

Std Pack	Description	Nylon	Poly
25	3/4" MGHT X 3/4" MPT (A)	E34	3E34
25	3/4" FGHT Nut with 1/2" hole (B)	B34I2	3B34I2
25	3/4" MGHT X 1/2" MPT (C)	E34I2	3E34I2



ROPE WICK PARTS UNASSEMBLED

Ref. Letter	Std Pack	Description	Nylon	Poly
A	100	Nylon Washer	RW1116A	3RW1116A
B	50	Main Body	RW1116B	-
C	100	O-ring Black EPDM	RW1116C	RW1116C
D	100	Grommet Black EPDM	RW1116D	RW1116D
E	25	1-1/16" - 16 UN (Lock) Nut	B12	3B12
F	25	1-1/16" - 16 UN Swivel Nut	8027	38027



HOSE-SAVER STRAIGHT ASSEMBLY - NYLON

MPT X HB	Part Number	Cap Part Number
3/4" X 3/4" (19 mm)	626320N	626012
3/4" X 1" (25 mm)	626325N	626014
1" X 1" (25 mm)	626425N	626014
1-1/4" X 1" (25 mm)	626525N	626014
1-1/4" X 1-1/4" (32 mm)	626532N	626014
1-1/2" X 1-1/4" (32 mm)	626632N	626014
1-1/2" X 1-1/2" (38 mm)	626638N	-
1-1/2" X 2" (50 mm)	626651N	-
2" X 2" (50 mm)	626751N	-



HOSE-SAVER ELBOW ASSEMBLY - NYLON

MPT X HB	Part Number	Cap Part Number
3/4" X 3/4" (19 mm)	627320N	626012
3/4" X 1" (19 mm)	627325N	626014
1" X 3/4" (19 mm)	627420N	626012
1" X 1" (19 mm)	627425N	626014
1" X 1-1/4" (19 mm)	627432N	626014
1-1/4" X 1" (19 mm)	627525N	626014
1-1/4" X 1-1/4" (19 mm)	627532N	626014
1-1/2" X 1-1/4" (19 mm)	627632N	626014
1-1/2" X 1-1/2" (19 mm)	627638N	-
2" X 2" (19 mm)	627751N	-

MALE PIPE THREAD BY HOSE BARB



MPT x HB	316 Stainless Steel
1/4" X 1/4" (6.4 mm)	9A14
1/4" X 3/8" (10 mm)	9A1438
1/4" X 1/2" (13 mm)	9A1412
3/8" X 3/8" (10 mm)	9A38
3/8" X 1/2" (13 mm)	9A3812
1/2" X 1/2" (13 mm)	9A12
3/4" X 3/4" (19 mm)	9A34
1" X 1" (25 mm)	9A100
1-1/4" X 1-1/4" (32 mm)	9A114
1-1/2" X 1-1/2" (38 mm)	9A112
2" X 2" (50 mm)	9A200
3" X 3" (75 mm)	9A300



STREET ELBOW: FEMALE PIPE THREAD BY MALE PIPE THREAD

MPT X FPT	304 Stainless Steel
1/4" X 1/4"	7SE14
3/8" X 3/8"	7SE38
1/2" X 1/2"	7SE12
3/4" X 3/4"	7SE34
1" X 1"	7SE100
1-1/2" X 1-1/2"	7SE112
1-1/4" X 1-1/4"	7SE114
2" X 2"	7SE200
3" X 3"	7SE300

COUPLING: FEMALE PIPE THREAD



FPT X FPT	304 Stainless Steel
1/4" X 1/4"	7FC14
1/2" X 1/2"	7FC12
3/4" X 3/4"	7FC34
1" X 1"	7FC100
1-1/2" X 1-1/2"	7FC112
2" X 2"	7FC200
3" X 3"	7FC300



TEE: FEMALE PIPE THREAD

FPT X FPT X FPT	304 Stainless Steel
1/4"	7TT14
1/2"	7TT12
3/4"	7TT34
1"	7TT100
1-1/4"	7TT114
1-1/2"	7TT112
2"	7TT200

ELBOW: FEMALE PIPE THREAD - 90°



FPT X FPT	304 Stainless Steel
1/4" X 1/4"	7LL14
1/2" X 1/2"	7LL12
1" X 1"	7LL100
1-1/2" X 1-1/2"	7LL112
1-1/4" X 1-1/4"	7LL114
2" X 2"	7LL200
3" X 3"	7LL300



NIPPLE

MPT X Length	304 Stainless Steel
1/4" X 1-1/2"	714112
1/4" X 3"	714300
1/4" X 4"	714400
1/4" X 6"	714600
1/4" X 12"	7141200
3/8" X 1"	738100
3/8" X 1-1/2"	738112
1/2" X 1-1/8"	712118
1/2" X 1-1/2"	712112
1/2" X 2"	712200
3/4" X 1-3/8"	734138
3/4" X 4"	734400
1" X 1-1/2"	7100112
1" X 4"	7100400
1-1/4" X 1-5/8"	7114158
1-1/2" X 1-3/4"	7112134
2" X 2"	7200200
2" X 2-1/2"	7200212
2" X 4"	7200400
2" X 6"	7200600
2" X 3"	7200300
2" X 3-1/2"	7200312
2" X 5"	7200500

REDUCER BUSHING



MPT X FPT	304 Stainless Steel
1/4" X 3/8"	7RB1418
3/8" X 1/4"	7RB3814
1/2" X 1/4"	7RB1214
1/2" X 3/8"	7RB1238
3/4" X 1/4"	7RB3414
3/4" X 1/2"	7RB3412
1" X 1/2"	7RB10012
1" X 3/4"	7RB10034
2" X 1-1/2"	7RB200112



HEX PLUGS

Part Number	Size
7F18	1/8"
7F14	1/4"
7F38	3/8"
7F12	1/2"
7F34	3/4"
7F100	1"
7F200	2"

FITTINGS - STEEL

FITTINGS - BRASS



MALE PIPE THREAD BY HOSE BARB

MPT X HB	Steel
1/8" X 1/4" (6.4 mm)	A1814S
1/8" X 3/8" (10 mm)	A1838S
1/4" X 1/4" (6.4 mm)	A14S
1/4" X 3/8" (10 mm)	A1438S
1/4" X 1/2" (13 mm)	A1412S
3/8" X 1/4" (6.4 mm)	A3814S
3/8" X 3/8" (10 mm)	A38S
3/8" X 1/2" (13 mm)	A3812S
1/2" X 1/4" (6.4 mm)	A1214S
1/2" X 3/8" (10 mm)	A1238S
1/2" X 1/2" (13 mm)	A12S
1/2" X 5/8" (16 mm)	A1258S
1/2" X 3/4" (19 mm)	A1234S
3/4" X 3/8" (10 mm)	A3438S
3/4" X 1/2" (13 mm)	A3412S
3/4" X 5/8" (16 mm)	A3458S
3/4" X 3/4" (19 mm)	A34S
3/4" X 1" (25 mm)	A34100S
1" X 1" (25 mm)	A100S

Add Prefix "BG-" for 1 part per retail bag.



MALE PIPE THREAD BY HOSE BARB

MPT X HB	Brass
1/8" X 1/4" (6.4 mm)	A1814B
1/8" X 3/8" (10 mm)	A1838B
1/4" X 1/4" (6.4 mm)	A14B
1/4" X 3/8" (10 mm)	A1438B
1/4" X 1/2" (13 mm)	A1412B
3/8" X 1/4" (6.4 mm)	A3814B
3/8" X 3/8" (10 mm)	A38B
3/8" X 1/2" (13 mm)	A3812B
1/2" X 1/4" (6.4 mm)	A1214B
1/2" X 3/8" (10 mm)	A1238B
1/2" X 1/2" (13 mm)	A12B
1/2" X 5/8" (16 mm)	A1258B
1/2" X 3/4" (19 mm)	A1234B
3/4" X 3/8" (10 mm)	A3438B
3/4" X 1/2" (13 mm)	A3412B
3/4" X 5/8" (16 mm)	A3458B
3/4" X 3/4" (19 mm)	A34B
3/4" X 1" (25 mm)	A34100B
1" X 1" (25 mm)	A100B

KING NIPPLE



MPT X HB	Plated Steel
3/4" (19 mm)	AA34P
1" X 3/4" (19 mm)	AA10034P
1" (25 mm)	AA100P
1-1/4" (32 mm)	AA114P
1-1/2" (38 mm)	AA112P
2" (50 mm)	AA200P

Add Prefix "BG-" for 1 part per retail bag.



FEMALE PIPE THREAD BY HOSE BARB

FPT X HB	Brass
1/4" X 3/8" (10 mm)	AF1438B



FEMALE PIPE STRAIGHT SWIVEL NUT - HEX

FPS	Steel
3/4"	B35S

NOTE: For use with steel flat hose barb 1/4" to 3/4".



STREET ELBOWS: FEMALE PIPE THREAD BY MALE PIPE THREAD

MPT X FPT	Brass
1/4" X 1/4"	SE14B
3/8" X 3/8"	SE38B
1/2" X 1/2"	SE12B



FLAT SEAT HOSE BARB

HB	Steel
1/2" (12 mm)	C12S
3/4" (19 mm)	C34S



HOSE MENDER

HB	Brass
1/4" (6.4 mm) X 1/4" (6.4 mm)	SHM14B
3/8" (10 mm) X 3/8" (10 mm)	SHM38B
1/2" (12 mm) X 1/2" (12 mm)	SHM12B
5/8" (16 mm) X 5/8" (16 mm)	SHM58B
3/4" (19 mm) X 3/4" (19 mm)	SHM34B



FLAT SEAT HOSE BARB

HB	Brass
3/8" (10 mm)	C38B
1/2" (13 mm)	C12B
5/8" (16 mm)	C58B
3/4" (19 mm)	C34B



**SWIVEL NUT
HEX FEMALE GARDEN HOSE THREAD**

FGHT	Brass
3/4"	B33B



**COUPLINGS:
FEMALE PIPE THREAD**

FPT X FPT	Brass
1/4" X 1/4"	FC14B
1/2" X 1/2"	FC12B



MALE GARDEN HOSE THREAD BY HOSE BARB

MGHT X HB	Brass
3/4" X 3/8" (10 mm)	D3438B
3/4" X 1/2" (13 mm)	D3412B
3/4" X 5/8" (16 mm)	D3458B
3/4" X 3/4" (19 mm)	D34B



SWIVEL ADAPTER

MPT	Brass
3/8"	SA38B
1/2"	SA12B



**ADAPTERS:
MALE GARDEN HOSE THREAD BY MALE PIPE THREAD**

MGHT X MPT	Brass
3/4" X 1/2"	E3412B
3/4" X 3/4"	E34B



**ELBOWS:
FEMALE PIPE THREAD - 90°**

FPT X FPT	Brass
1/4" X 1/4"	LL14B
1/8" X 1/8"	LL18B



HEX PLUG WITH MALE PIPE THREAD

MPT	Brass
1/4"	F14B
3/8"	F38B
1/2"	F12B



REDUCER BUSHINGS

MPT X FPT	Brass
1/4" X 1/8"	RB1418B
1/2" X 1/4"	RB1214B
1/2" X 3/8"	RB1238B
3/4" X 1/2"	RB3412B



FEMALE GARDEN HOSE SWIVEL NUT - KNURLED

FGHT	Brass
3/4"	B34B

NOTE: For use with flat seat hose barbs 1/4" to 3/4".

CABLE TIES AND CLAMPS



CABLE TIES

Standard Pack	Length		Part Number White Nylon	Part Number Black UV Nylon
	US Units	Metric Units		
100	4 inch	102 mm	NS4	3NS4
100	6-1/8 inch	156 mm	NS7	3NS7
100	7-1/2 inch	170 mm	NS8	3NS8
100	11-1/2 inch	292 mm	NS12	3NS12
100	17-3/4 inch	450 mm	NS17	3NS17
100	21-3/4 inch	552 mm	NS21	3NS21
100	28-3/8 inch	720 mm	NS28	3NS28
100	37-1/4 inch	946 mm	NS32	3NS32



HOSE CLAMPS

Part Number	Fits Hose Min		Fits Hose Max		Normal Hose Size*	
5/16 inch BAND						
4JM	7/32 inch	5,6 mm	5/8 inch	16 mm	1/4 inch	6,4 mm
6JM	5/16 inch	8 mm	7/8 inch	22 mm	3/8 inch	10 mm
8JM	7/16 inch	11 mm	1 inch	25 mm	1/2 inch	13 mm
10JM	1/2 inch	13 mm	1 1/16 inch	27 mm	5/8 inch	16 mm
12JM	9/16 inch	14 mm	1 1/4 inch	32 mm	3/4 inch	19 mm
16JM	1 1/16 inch	18 mm	1 1/2 inch	38 mm	1 inch	25 mm
1/2 inch BAND						
6J	3/8 inch	10 mm	7/8 inch	22 mm	3/8 inch	10 mm
8J	7/16 inch	11 mm	1 inch	25 mm	1/2 inch	13 mm
10J	9/16 inch	14 mm	1-1/16 inch	27 mm	5/8 inch	16 mm
12J	9/16 inch	14 mm	1-1/4 inch	32 mm	3/4 inch	19 mm
16J	1 1/16 inch	18 mm	1-1/2 inch	38 mm	1 inch	25 mm
20J	3/4 inch	19 mm	1-3/4 inch	44 mm	1-1/4 inch	32 mm
24J	1-1/16 inch	27 mm	2 inch	50 mm	1-1/2 inch	38 mm
28J	1-5/16 inch	33 mm	2-1/4 inch	57 mm	1-3/4 inch	44 mm
32J	1-9/16 inch	40 mm	2-1/2 inch	64 mm	2 inch	50 mm
36J	1-13/16 inch	46 mm	2-3/4 inch	70 mm	2-1/4 inch	57 mm
40J	2-1/16 inch	52 mm	3 inch	76 mm	2-1/2 inch	64 mm
44J	2-5/16 inch	59 mm	3-1/4 inch	83 mm	2-3/4 inch	70 mm
48J	2-9/16 inch	65 mm	3-1/2 inch	89 mm	3 inch	76 mm
52J	2-13/16 inch	71 mm	3-3/4 inch	95 mm	3-1/4 inch	83 mm
56J	3-1/16 inch	78 mm	4 inch	102 mm	3-1/2 inch	89 mm
64J	3-1/2 inch	89 mm	4-1/2 inch	114 mm	4 inch	102 mm

NOTE: 10 per box - order in box multiples

* Hose sizes are based on inside I.D.

SEALANT



RECTOR SEAL

Part Number	Type	Container	
		US Units	Metric Units
28651	21 Black Jack	1/2 Pint Can	.24 Litre
28541	21 Black Jack	1 Pint Can	.47 Litre



LIQUID TEFLON SEALANT

Part Number	Size		Container
	US Units	Metric Units	
LT2	2 oz.	59 mL	Tube
LT4	4 oz.	118 mL	Can
LT8	8 oz.	237 mL	Can



TEFLON TAPE

Part Number	Size		Container
	US Units	Metric Units	
1252	1/2"	13 mm	520"

INDEX

Part Number	Page	Part Number	Page	Part Number	Page	Part Number	Page
002201-3430	239	10BG-30-DC-01	168, 171	1541A-SP	66	18103B-050	254
002201-3440	239	10BG-30-DC010	168	1542A-160HSP	66	18103D2N	254
002201-3460	239	10BG-30-DC-015	168, 171	1542A-65SP	66	18103E2	254
002201-3470	239	10BG-30-DC018	168	1542P-160HSP	62	18103F2N	254
003430	239	10BG-30-DC-02	168, 171	1542P-160HUSP	62	18104B-050	254
003440	239	10BG-30-DC023	168	1542P-200HSP	62	18105B-050	254
003460	239	10BG-30-DC-03	168, 171	1542P-55SP	62	18106B-050	254
003470	239	10BG-30-DC-035	168	1542P-65ESP	62	18107B-050	254
01134343010	225	10BG-30-DC-04	168, 171	1542P-65SP	62	18109B-050	254
0113434307	225	10BG-30-DC-05	168, 171	1542P-65SPM	62	18123B-050	254
0113434308	225	10BG-30-DC-06	168, 171	1542P-65USP	62	18124B-050	254
0135606H	229	10BG-30-DC-07	168, 171	1542PV-65SP	62	18125B-050	254
01WSHR13	130	10BG-30-DC-08	168, 171	1543A-160HSP	66	18126B-050	254
02050D12	254	10BG-30-DC-10	168, 171	1543A-160HTSP	66	18127B-050	254
02050E12	254	10BG-30-DC-12	168, 171	1543A-65SP	66	18129B-050	254
02050F12	254	10JM	263	1543A-65TSP	66	1824C	121
02075A34	253	10J	263	1543P-130ESP	62	1825C	121
02075B34	253	1212S18	193	1543P-130ESP-01	62	1826C	121
02075C34	253	1252	263	1543P-130SP	62	1827C	121
02075D34	254	12JM	263	1543P-390EHSP	62	203282152	235
02075E34	254	12J	263	1543P-390EHUSP	62	203282153	235
02075F34	254	1320-0015	76, 77	1550-BSP	56	2032821535	235
02075G34	254	1320-0016	76, 77	1550-SP	56	203282162	235
02075P34	254	1320-0054	77	1550	56	203282163	235
02100A10	253	1320-0080	76	1551-BSP	53	2032821635	235
02100B10	253	1320-0081	76	1551-SP	53, 56	2087-593-135	100
02100C10	253	1321-0012	76, 77	1551	52, 56	2088-313-145	100
02100D10	254	1321-0013	76, 77	1552C-130	52	2088-343-135	100
02100E10	254	1323-0072	76, 77	1552C-130E	52	2088-343-170	101
02100F10	254	1323-0073	76, 77	1552C-130ESP	53	2088-343-500	101
02100G10	254	1323-0076	76, 77	1552C-130SP	53	2088-394-144	101
02100P10	254	1323-0078	77	1572-SPX	67	2088-394-154	101
02125A54	253	1323-0079	77	1573-SPX	67	2088-443-144	100
02125B54	253	141418	193	15-14	247	2088-564-144	101
02125C54	253	1442P-65SP	62	15Q2530TC	198	20J	263
02125D54	254	1502C	75	166-200-36	102	20N62230	235
02125E54	254	1502N	75	166-200-46	102	20N62250	235
02125F54	254	1502XL	75	166-200-56	102	20N62280	235
02150A64	253	1510-0001	91	166-200-57	102	20N62330	235
02150B64	253	1510-0002	91	16842490	197	20N62350	235
02150C64	253	1510-0016	91	16842491	197	20N62380	235
02150D64	254	1510-0075	91	16JM	263	20N62430	235
02150E64	254	1510-0135	234	16J	263	20N62450	235
02150F64	254	1520-0034	60	16Q2530TC	198	20N62480	235
02150G64	254	1520-1075	226	1700-0044	236	20N62530	235
02150P64	254	1520-1075SS	226	1700-0045	236	20N62550	235
02200A20	253	1520-1100	226	1700-0057	236	20N62580	235
02200B20	253	1520-1100SS	226	1700-0058	236	20N62630	235
02200C20	253	1520-1125	226	1700-0064	236	20N62650	235
02200D20	254	1520-1125SS	226	1700-0065	236	20N62680	235
02200E20	254	1520-1150	226	1700-0090	235	2102030	253
02200F20	254	1520-1150SS	226	1700-0091	235	2120-0070	65
02200G20	254	1521C-65	52	1700-0092	235	2120-0071	65
02200P20	254	1521C-65M	52	1700C	74	2130P-A055	128
02300A30	253	1522C-65SP	53	1700N	74	2130P-A079	128
02300B30	253	152607TC	198	1700XL	74	2130P-D183	128
02300C30	253	1530-0024S	59	171N-100	248	2130P-D355	128
02300D30	254	1530-0028S	59	171N-112	248	2130P-D359	128
02300E30	254	1532C-160HSP	65	171N-114	248	2130P-D395	128
02300F30	254	1532C-6SP	65	171N-12	248	2130P-D399	128
02300G30	254	1533C-13ESP	65	171N-14	248	2130PX	128
02300P30	254	1533C-13SP	65	171N-200	248	2132P-D183	129
02-050G	254	1533C-390EHSP	65	171N-34	248	2132P-D355	129
02-100G	254	1536-SP	55	171N-38	248	2132P-D359	129
02-150G	254	1536	54	1721-0010	130	2132P-D395	129
02-200G	254	1537-SP	55	1721-0220	221	2132P-D399	129
02-300G	254	1537	54	1723-0142	221	2132PX	129
10BG-1700-0255	168, 197	1538-SP	53, 55	1802C	121	2133P-D355	129
10BG-2270-0150	141, 147, 149, 153, 159, 161, 163, 167, 187, 197, 198	1538	52, 54, 55	1803C	121	2133P-D395	129
		1539-SP	55	1804C	121	2133PX	129
		1539	54	1805C	121	2150P-D05AC	130
		1540-SP	55	1806C	121	2150P-D35DC	130
10BG-30-DC-00	168	1540	54	1807C	121	2150P-D39DC	130

INDEX

Part Number	Page	Part Number	Page	Part Number	Page	Part Number	Page
2150PX	130	2410-0053	217	2520-0218	215	2850-0027	215
2160-0038	91, 125	2410-0054	217	2520-0219	215	2854I	263
2160-0047	91, 125	2410-0055	217	2520-0239	214	2865I	263
2160-0048	91, 125	2410-0056	217	2520-0240	214	28J	263
2160-0096	60	2410-0057	217	2520-0241	214	28OC02	183
2220B-AP	116	2410-0058	217	2520-0242	214	28OC03	183
2220B-HP	116	2410-0059	217	2520-0243	214	28OC04	183
2220B-P	116	2410-0060	217	2520-0244	214	28OC06	183
2221B-AP	116	2410-0061	217	2520-0245	214	28OC08	183
2221B-HP	116	2410-0062	217	2520-0259	214	28OC12	183
2221B-P	116	2410-0063	217	2526-0011	18, 19, 60	28OC16	183
2230B-AP	116	2410-0064	217	2535S	110	2910-0026	222
2230B-HP	116	2410-0065	217	2541-0045	134	2910-0037	225
2230B-P	116	2410-0066	217	2541-0046	134	3000-0310	199
2231B-AP	116	2410-0067	217	2541-0048	134	3000-100	103
2231B-CP	116	2410-0068	217	2541-0049	134	3000-350	103
2231B-HP	116	2410-0069	217	2541-0051	134	3010-000	105
2231B-P	116	2410-0070	217	2541-0053	134	3010-0001	76
2270-0136	197	2410-0071	217	2541-0054	134	3010-0002	76
22W11MF64V	197	2410-0072	217	2541-0055	134	3010-0003	76
2300-0067	214	2410-0073	217	2541-0065	134	3010-0004	76
2304B-P	114	2410-0074	217	2545S	110	3010-0005	76
2314B-P	114	2410-0075	217	2549-0043	134	3010-0006	76
2330B-P	114	2410-0076	217	255-223	105	3010-0010	76
2340B-P	114	2410-0077	217	255-313	105	3010-0014	76
2345B-P	114	2410-0078	217	255-323	105	3010-0020	76
234-2916	106	2410-0079	217	255-413	105	3010-0061	60
234-2926	106	2410-0080	217	255-568	105	3010-0064	60
234-2936	106	2410-0081	217	255-613	105	3010-0066	60, 76
234-2946	106	2410-0082	217	255-623	105	3010-0067	60, 76
234-3916	106	2410-0083	217	255-646	105	3010-0068	76
234-3926	106	2410-0084	217	2640-0001	248	3010-0168	60
234-3936	106	2410-0085	217	2640-0002	248	3010-EX0004	223
234-3946	106	2410-0086	217	2640-0003	248	3010-WR0008	223
2351B-P	114	2410-0087	217	2640-0004	248	3011-0006	76
2354B-CP	114	2410-0088	217	2640-0005	248	3011-0021	76
2359B-P	114	2410-0089	217	2640-0007	248	301AF0.4-65	194
2359B-PY	114	2410-0090	217	2640-0008	248	301AF0.7-80	194
2404-0019	125	2410-0091	217	2640-0009	248	301AF0.7-80W	194
2404-0030	125	2410-0092	217	2640-0010	248	301AF1.2-105C	194
2404-0419	130	2410-0093	217	2640-0011	248	301AF1.6-100	194
2404-0427	130	2410-0094	217	2640-0014	248	301AF5.0-70	194
2410-0021	217	2410-0095	217	2642-0001	124	301AFD0.7-80	194
2410-0022	217	2410-0096	217	27101612	194	301AFD1.2-105	194
2410-0023	217	2410-0097	217	2728-1001	78, 127	301AFD1.6-100	194
2410-0024	217	2410-0098	217	2729-1001	78, 127	301AFUSA0.5	194
2410-0025	217	2410-0099	217	2729-1002	78, 127	301AFUSA1.0	194
2410-0026	217	2410-0100	217	2729-1003	78, 127	301AFUSA2.0	194
2410-0027	217	2410B-P	112	2729-1005	78, 127	301AFUSA3.0	194
2410-0028	217	2411B-P	112	2729-1006	78, 127	301MNF-W	194
2410-0029	217	2412B-P	112	2738-1001	78, 127	3020-0008	60
2410-0030	217	2413B-P	112	2738-1002	78, 127	3020-0009	60, 76
2410-0031	217	2414B-P	112	2738-1003	78, 127	3021-0006	218
2410-0032	217	2430B-P	112	2738-1004	78, 127	3040-0015	199
2410-0033	217	2431B-P	112	2739-1001	78, 127	3040-0016	199
2410-0034	217	2432B-P	112	2739-1002	78, 127	3040-0017	199
2410-0035	217	2433B-P	112	2739-1003	78, 127	3040-0018	199
2410-0036	217	2434B-P	112	2739-1004	78, 127	3040-0019	199
2410-0037	217	244-3366	106	2739-1005	78, 127	3040-0020	199
2410-0038	217	244-5126	106	2739-1006	78, 127	3040-0021	199
2410-0039	217	244-6128	106	2739-1009	78, 127	30-CR-13	171
2410-0040	217	24J	263	2740-1001	78, 127	30-CR-23	171
2410-0041	217	251032BL	193	2740-1002	78, 127	30-CR-25	171
2410-0042	217	251032GY	193	2740-1005	78, 127	30-CR-45	171
2410-0043	217	251032WH	193	2740-1007	78, 127	30-DC010	168
2410-0044	217	2510-0001	125	2741-1001	78, 127	30-DC018	168
2410-0045	217	2510-0007	125	2741-1002	78, 127	30-DC023	168
2410-0047	217	2510-0017	125	2741-1003	78, 127	30-DC-00	168
2410-0048	217	2510-0029	125	2741-1004	78, 127	30-DC-01	168, 171
2410-0049	217	2510-0030	126	2741-1005	78, 127	30-DC-015	168, 171
2410-0050	217	2510-0031	126	2741-1007	78, 127	30-DC-02	168, 171
2410-0051	217	2520-0216	215	2801-0001	91	30-DC-03	168, 171
2410-0052	217	2520-0217	215	2801-0002	91	30-DC-035	168

INDEX

Part Number	Page	Part Number	Page	Part Number	Page	Part Number	Page
30-DC-04	168, 171	3312-0005	123	3350-0079A	235	3351-0042	235
30-DC-05	168, 171	3316-0002	78	3350-0079F	236	3351-0043	235
30-DC-06	168, 171	3320-0051A	60	3350-0082	236	3360-0021A	60
30-DC-07	168, 171	3320-0052A	60	3350-0082A	235	3360-0023A	60
30-DC-08	168, 171	3320-0064	109	3350-0082F	236	3360-0027	60
30-DC-10	168, 171	3320-0065	247	3350-0085	236	3365-0002	240
30-DC-12	168, 171	3320-0077	60	3350-0085A	235	3365-0004/24	240
30AN01.2	196	3324-1000.85	241	3350-0085F	236	3365-0004/36	240
30AN01.8	196	3324-1001.05	241	3350-0112	236	3365-0004/47	240
30AN02.4	196	3324-1001.1	241	3350-0112A	235	3365-0005/24	240
30AN0.6	196	3324-1001.2	241	3350-0113	236	3365-0005/36	240
30B4SNF70E35	230	3324-1001.25	241	3350-0113A	235	3365-0005/47	240
30DT0.5	165, 196	3324-1001.3	241	3350-0114	236	3365-0007/14	240
30DT0.75	165, 196	3324-1001.35	241	3350-0114A	235	3365-0007/24	240
30DT10	165	3324-1001.4	241	3350-0115	236	3365-0007/36	240
30DT15	165	3324-1001.45	241	3350-0116	236	3371-0019	231
30DT1.0	165, 196	3324-1001.5	241	3350-0117	236	3371-0028	231
30DT1.5	165, 196	3324-2000.85	241	3350-0126	126	3371-0034S	233
30DT20	165	3324-2001.05	241	3350-0127	126	3371-0036	233
30DT2.0	165	3324-2001.1	241	3350-0128	126	3371-0036R	233
30DT2.5	165	3324-2001.15	241	3350-0131	236	3371-0037R	233
30DT3.0	165	3324-2001.2	241	3350-0132	236	3371-0038	233
30DT4.0	165	3324-2001.25	241	3350-0134	126	3371-0038R	233
30DT5.0	165	3324-2001.3	241	3350-0142N	235	3371-0039R	233
30DT7.5	165	3324-2001.35	241	3350-0143N	235	3371-0040	233
30FCX02	181	3324-2001.4	241	3350-0144N	235	3371-0040R	233
30FCX03	181	3324-2001.45	241	3350-0145N	235	3371-0041R	233
30FCX04	181	3324-2001.5	241	3350-0146N	235	3371-0044	234
30FCX05	181	3341-0001	123	3350-0147N	235	3371-0045	234
30FCX06	181	3341-0002	123	3350-0148N	235	3371-0046	234
30HAF01110	194	3341-0003	123	3350-0149N	235	3371-0047	234
30HAF01480	194	3341-0004	123	3350-0150N	235	3371	231
30HAF01570	194	3350-0021	126	3350-0151N	235	3375-0008	124
30HAF01-65	194	3350-0022	126	3350-0152N	235	3375-0012	124
30HCX10	174	3350-0032	236	3350-0153N	235	3375-0015-10	124
30HCX12	174	3350-0033	126	3350-0154N	235	3375-0015-2	124
30HCX18	174	3350-0034	236	3350-0155N	235	3375-0015-3	124
30HCX2	174	3350-0034A	235	3350-0156N	235	3375-0015-4	124
30HCX3	174	3350-0035	236	3350-0157N	235	3375-0015-5	124
30HCX4	174	3350-0035A	235	3350-0158N	235	3375-0015-6	124
30HCX6	174	3350-0040	236	3350-0159N	235	3375-0015-7	124
30HCX8	174	3350-0040A	235	3350-0160N	235	3375-0015-8	124
30HCX9	174	3350-0042	236	3350-0161N	235	3375-0015-9	124
30PFAF013-105	193	3350-0043	236	3350-0162N	235	3375-0017-10	124
30PFAF013-105BL	193	3350-0043A	235	3350-0163N	235	3375-0017-2	124
30Q2603-20	197	3350-0044	236	3350-0164N	235	3375-0017-3	124
30Q3579A	145	3350-0045	236	3350-0165N	235	3375-0017-4	124
30Q3834	198	3350-0046	236	3350-0166N	235	3375-0017-5	124
32100010	198	3350-0046A	235	3350-0167N	235	3375-0017-6	124
32100050	198	3350-0056	236	3350-0168N	235	3375-0017-7	124
32100200	194	3350-0056A	235	3350-0169N	235	3375-0017-8	124
32100510	198	3350-0057	236	3350-0170N	235	3375-0017-9	124
32100530	198	3350-0057A	235	3350-0171N	235	3375-0021	124
32100550	198	3350-0058	236	3350-0172N	235	3375-0025	130
3219503269	193	3350-0058A	235	3350-0173N	235	3376-0870	232
32J	263	3350-0059	236	3351-0005	236	3376-0871	232
32PIFA250	194	3350-0059A	235	3351-0006	236	3376-1170	232
3300-0001	78, 130	3350-0060	236	3351-0007	236	3376-1171	232
3300-0002	78, 130	3350-0061	236	3351-0013	236	3376-1670	232
3300-0015	78, 130	3350-0062	236	3351-0014	236	3376-1671	232
3300-0016	78, 130	3350-0068	236	3351-0015	236	3377-1170	232
3300-0084	123	3350-0069	236	3351-0016	236	3377-1171	232
3300-0087	93	3350-0071	236	3351-0020	236	3377-1670	232
3300-0088	93	3350-0071A	235	3351-0022	236	3377-1671	232
3300-0093	78	3350-0072	236	3351-0024	236	3378-1140	234
3300-0094	78	3350-0072A	235	3351-0026	236	3378-1140-2BYP	234
3300-0098	78, 130	3350-0073	236	3351-0035	235	3378-1140-3BYP	234
3300-0102	123	3350-0073A	235	3351-0036	235	3378-1160	234
3300-0103	123	3350-0074	236	3351-0037	235	3378-1160-2BYP	234
3301-0001	78, 130	3350-0075	236	3351-0038	235	3378-1160-3BYP	234
3305-0011	214, 223	3350-0076	236	3351-0039	235	3378-1640	234
3305-0112	247	3350-0077	236	3351-0040	235	3378-1640-2BYP	234
3312-0004	123	3350-0079	236	3351-0041	235	3378-1640-3BYP	234

INDEX

Part Number	Page	Part Number	Page	Part Number	Page	Part Number	Page
3378-1660	234	3430-0445	36	3470-0203	245	356061	229
3378-1660-2BYP	234	3430-0456	60	3470-0204	245	3562060-090	229
3378-1660-3BYP	234	3430-0464	52, 53, 56	3470-0205	250	356240	229
33812D	225	3430-0476	50	3470-0206	245	356241	229
3381-0010	238	3430-0477	50	3470-0207	245	356260	229
3381-0011	238	3430-0478	50	3470-0208	245	356261	229
3381-0013	238	3430-0479	50	3470-0209	245	356640-020NB	229
3381-0016	237	3430-0480SP	12, 16, 34, 49	3470-0301	245	36J	263
3381-0018	240	3430-0481BSP	19, 39	3470-0302	245	3800-0025	235, 236
3381-0018W	240	3430-0481SP	19, 39	3470-0303	245	3800-0026	235, 236
3381-0021	237	3430-0482SP	16, 55	3470-0305	245	3800-0029	235, 236
3381-0032	240	3430-0500	38	3470-0306	245	3800-0035	126
3381-0032W	240	3430-0537	18, 19	3470-0307	245	3800-0040	235, 236
3381-0034	240	3430-0540	76, 77	3470-0308	245	3800-0041	235, 236
3381-0036	237	3430-0589	14, 15, 16, 20, 25, 26, 27, 28, 30, 34, 40, 41, 49, 50, 52, 53, 54, 55, 58	3470-0401	245	3800-0042	235, 236
3381-0043	237			3470-0402	245	3800-0043	235, 236
3381-0043L	237			3470-0403	245	3800-0044	235, 236
3385-1500	238			3470-0601	246	3800-0045	235, 236
3385-2300	238	3430-0590	13, 22, 23, 24, 50, 58	3470-0602	246	3800-0046	235, 236
3385-3000	238	3430-0591	11, 12, 58	3470-0603	246	3800-0047	235, 236
3385-3500	238	3430-0592	60	3470-0604	246	3800-0048	235, 236
3385-4000	238	3430-0593	36, 58	3470-0605	246	3800-0065	235, 236
3385-4500	238	3430-0601	38, 39, 58	3470-0700	246	3800-0066	235, 236
3385-5000	238	3430-0604	21, 46, 48, 58,	3470-0702	246	3800-0067	235, 236
3385-5500	238	3430-0633	130	3470-0800	246	3800-0074	125
3385-6000	238	3430-0634	130	3470-0801	246	3800-0086	235
3385-7000	238	3430-0635	62, 63	34-006	105	3800-0087	235
338D	225	3430-0636	76	34-007	105	3800-0088	235
3390-0006	122	3430-0645	110	3502420	229	3800-0089	235
3390-0007	122	3430-0646	18, 19, 58	3502440	229	3800-0090	235
3390-0037	122	3430-0650	60	3502460	229	3800-0091	235
3390-0062D	122, 130	3430-0659	62, 63	350401	229	3800-0092	235
3390-0063D	122	3430-0673CSP	65	350420-020	229	3800-0093	235
3390-0067D	122	3430-0674CSP	65	350440-020	229	3800-0094	235
3390-0071D	122	3430-0675	65	350460-020	229	3800-0095	235
3390-0072D	122	3430-0676	65	350480-020	229	3800-0096	235
3390-0076	122	3430-0690	62, 63	350480	229	3800-0097	235
3390-0079	122	3430-0691	62, 63	350620-020	229	38027	225, 259
3390-0081	122	3430-0692	62, 63, 64	350640-020	229	3812D	225
3390-0102	122	3430-0692-02	62, 63, 64	350640	229	383818	193
3390-0104/3A	122	3430-0699	110	350660	229	38D	225
33942	225	3430-0700	59	350680	229	3942	225
3396-0006	123	3430-0754	221	352000-020	229	3A100114	256
3396-0011	123	3430-0754V	221	352080-1	229	3A10034	256
3396-0014	123	3430-0755	221	352080	229	3A100	256
3396-0025	123	3430-0755V	221	352180-1	229	3A112114	256
3396-0031/2.1	122	3430-0757	62, 63, 64	352180	229	3A112	256
3396-0033/2.3	122	3430-0768	237	3522000	229	3A114100	256
3396-0034/1.8	122	3430-0779	52, 53, 56	3522040	229	3A114112	256
3410-0041	62, 63, 67	3430-0790	222	3522040-1	229	3A11434	256
3410-0042	62, 63, 64, 67	3430-0791	66	3522060	229	3A114	256
3410-0043	222	3430-0792	66	3522060-1	229	3A1214	256
3410-0044	222	3430-0793	66	3522100	229	3A1234	256
3420-0003	76	3430-0796	50	3522100-1	229	3A1238	256
3420-0004	76	3430-0797	60	3522120	229	3A1258	256
3420-0010	76	3430-0807	232	3522120-020	229	3A12	256
3420-0023	76	3430-0823	232	3522140	229	3A1412	256
3420-0024	76	3430-0838	62, 63, 64	3522140-020	229	3A1438	256
3420-0025	76	3430-0839	64	3522140-1	229	3A14	256
3430-0037	118	3430-0840V	218	3522160	229	3A1814	256
3430-0187	60	3430-0863	65	3522160-020	229	3A18316	256
3430-0332	14, 15, 16, 20, 25, 26, 27, 28, 30, 40, 41, 49, 50, 52, 53, 54, 55	3430-0943	62	3522160-1	229	3A1838	256
		3430-0944	234	3522221	229	3A200	256
		3430-0945	234	3522221-1	229	3A300	256
3430-0333	13, 22, 23, 24, 50	3430-0946	62, 63	354120	227	3A34100	256
3430-0334	11, 12	3470-0101	244	354142	227	3A3412	256
3430-0380	76	3470-0102	244	3542010	227	3A3414	256
3430-0381	76	3470-0103	244	3542110	227	3A3438	256
3430-0384	76	3470-0104	244	354230	227	3A3458	256
3430-0386	76	3470-0106	244	354320	227	3A34	256
3430-0387	76	3470-0107	244	356040	229	3A3812	256
3430-0390	76	3470-0201	245	356041	229	3A3814	256
3430-0437	76	3470-0202	245	356060	229	3A38516	256

INDEX

Part Number	Page	Part Number	Page	Part Number	Page	Part Number	Page
3A3858	256	3EL1838	256	3M12	257	3SHM200	258
3A38	256	3EL200HB	257	3M1418	257	3SHM34	258
3AF1214	256	3EL200	256	3M14	257	3SHM38	258
3AF1234	256	3EL300	256	3M18	257	3SHM58	258
3AF1238	256	3EL34100	256	3M200	257	3T100	258
3AF1258	256	3EL3412	256	3M3412	257	3T112	258
3AF12	256	3EL3412F	256	3M3438	257	3T114	258
3AF1438	256	3EL3414	256	3M34	257	3T1234T	258
3AF14	256	3EL3438	256	3M3814	257	3T1238T	258
3AF3412	256	3EL3458	256	3M3818	257	3T1238	258
3AF3438	256	3EL3458F	256	3M38	257	3T12C	225
3AF3458	256	3EL3458HB	257	3N34	259	3T12T	258
3AF34	256	3EL34F	256	3NB1612	225	3T12	258
3AF3812	256	3EL34HB	257	3NB1614	225	3T1438T	258
3AF3814	256	3EL34	256	3NF1614	225	3T1438	258
3AF38	256	3EL3812	256	3NS12	263	3T14T	258
3B100	130, 259	3EL3812F	256	3NS17	263	3T14	258
3B12	225, 259	3EL3814	256	3NS21	263	3T200	258
3B34	259	3EL3814F	256	3NS28	263	3T3412T	258
3B35	259	3EL3814HB	257	3NS32	263	3T3412	258
3C100	259	3EL3858	256	3NS4	263	3T3438T	258
3C12NPT	259	3EL38F	256	3NS7	263	3T3458T	258
3C12	259	3EL38HB	257	3NS8	263	3T34C	225
3C14	259	3EL38	256	3NTL12	225	3T34F	258
3C34	259	3EL58HB	257	3NTL14	225	3T34T	258
3C38	259	3ELD3412	258	3NTL34	225	3T34	258
3C58	259	3ELD3414	258	3NTL38	225	3T3812T	106, 258
3D100-015	143	3ELD3438	258	3NTL58	225	3T3812	258
3D100-02	143	3ELD34	258	3NTT12	225	3T38C	225
3D100-025	143	3F100	257	3NTT34	225	3T38T	258
3D100-03	143	3F112	257	3NTT38	225	3T38	258
3D100-035	143	3F114	257	3NTT58	225	3T58	258
3D100-04	143	3F12	257	3Q12	259	3TT100	257
3D100-05	143	3F14	257	3Q14	259	3TT112	257
3D100-06	143	3F18	257	3RB10012	257	3TT114	257
3D100-08	143	3F200	257	3RB10034	257	3TT12	257
3D3412	258	3F34	257	3RB112100	257	3TT14	257
3D3438	258	3F38	257	3RB112114	257	3TT200	257
3D3458	258	3FC100	257	3RB11234	257	3TT34	257
3D34	258	3FC112	257	3RB114100	257	400059P	224
3E3412	258, 259	3FC114	257	3RB11434	257	400059	224
3E3438	258	3FC12	257	3RB1214	257	400069P	224
3E34	258, 259	3FC200	257	3RB1218	257	400069	224
3EL10012	256	3FC34	257	3RB1238	257	4001C-H	70
3EL10034	256	3G3412	258	3RB1418	257	4001C	70
3EL100	256	3G3414	258	3RB200100	257	4001N-E2H	71
3EL112HB	257	3G34	258	3RB200112	257	4001N-EH	71
3EL112	256	3GTT1214	257	3RB200114	257	4001N-H	70
3EL114100	256	3GTT3414	257	3RB20034	257	4001N	70
3EL114112	256	3H34	258	3RB300200	257	4001XL-E2H	71
3EL11434	256	3HM1214	258	3RB3412	257	4001XL-EH	71
3EL114HB	257	3HM1238	258	3RB3414	257	4001XL-H	70
3EL114	256	3HM14	258	3RB3418	257	4001XL	70
3EL1214	256	3HM3814	258	3RB3438	257	402105-030	197
3EL1214HB	257	3HM516	258	3RB3814	257	4081BON	224
3EL1234	256	3HM5838	258	3RB3818	257	40867BN	224
3EL1234F	256	3I34	259	3RW1116A	259	40J	263
3EL1238	256	3J3412	258	3SE100	256	4101C-25	75
3EL1238HB	257	3K8412	225	3SE112	256	4101C-H	70
3EL1258	256	3K8414	225	3SE114	256	4101C	70
3EL1258F	256	3K8438	225	3SE12	256	4101N-E2H	71
3EL12F	256	3LL100	257	3SE14	256	4101N-EH	71
3EL12HB	257	3LL112	257	3SE200	256	4101N-H	70
3EL12	256	3LL114	257	3SE3445	257	4101N	70
3EL1412	256	3LL12	257	3SE34	256	4101XL-25	75
3EL14316	256	3LL200	257	3SE38	256	4101XL-E2H	71
3EL14316F	256	3LL34	257	3SHM100	258	4101XL-EH	71
3EL1438	256	3M10034	257	3SHM112	258	4101XL-H	70
3EL1438F	256	3M100	257	3SHM114	258	4101XL	70
3EL14F	256	3M112	257	3SHM1238	258	4111-035	102
3EL14HB	257	3M114	257	3SHM1258	258	413003	226
3EL14	256	3M1214	257	3SHM12	258	413004	226
3EL1814	256	3M1238	257	3SHM14	258	413005	226

INDEX

Part Number	Page	Part Number	Page	Part Number	Page	Part Number	Page
413013	226	4223N-B323	219	4243N-B328V	220	46463061	243
413014	226	4223N-B323V	219	4243N-B522	220	46473070	243
413015	226	4223N-B324	219	4243N-B522V	220	473070	243
413016	226	4223N-B324PSE	214	4243N-B523	220	48J	263
4200-0004E	223	4223N-B324V	219	4243N-B523V	220	4JM	263
4200-0004V	223	4223N-B327	219	4243N-B524	220	502069	231
4200-0010	223	4223N-B327V	219	4243N-B524V	220	5042015	247
4200-0010V	223	4223N-B328	219	4243N-B527	220	5042016	247
4200-0015N	226	4223N-B328V	219	4243N-B527V	220	5042017	247
4200-0016N	226	4223N-B329PSE	214	4243N-B528	220	5042019	247
4200-0019	226	4223N-B522	219	4243N-B528V	220	504203-HYP	231
4200-0020	223	4223N-B522V	219	4247N-B111	221	504210	231
4200-0020V	223	4223N-B523	219	4247N-B119	221	5059-1310-D011	95
4200-0025	223	4223N-B523PSE	214	4247N-B121	221	5059-1311-D011	95
4200-0030	223	4223N-B523V	219	4247N-B129	221	5059-3610-D011	95
4200-0030V	223	4223N-B524	219	4247N-C111	221	5059-3611-D011	95
4200-0040	223	4223N-B524PSE	214	4247N-C119	221	506530V	239
4200-0040V	223	4223N-B524V	219	4247N-C121	221	506531V	239
4200-0050	223	4223N-B527	219	4247N-C129	221	506532V	239
4200-0050V	223	4223N-B527PSE	214	4263N-B323D	220	520005	226
4200-0060	197	4223N-B527V	219	4263N-B323DV	220	5206C-H	118
4200-0061	197	4223N-B528	219	4263N-B323S	220	5206C	118
4200-0062	197	4223N-B528PSE	214	4263N-B323SV	220	5210C-H	118
4200-0063	197	4223N-B528V	219	4263N-B324D	220	5210C	118
4200-0082	197	4223N-B529PSE	214	4263N-B324DV	220	52169	231
4200-0083	197	4231N-B101D	221	4263N-B324S	220	52520005	226
4200-0111N	220	4231N-B101S	221	4263N-B324SV	220	52J	263
4200-0112N	220	4231N-B101T	221	4263N-B523D	220	5315C-HX	119
4200-0113N	220	4231N-B102D	221	4263N-B523DV	220	5315C-X	119
4200-0114N	220	4231N-B102S	221	4263N-B523S	220	5320C-HX	119
4200-0115N	220	4231N-B102T	221	4263N-B523SV	220	5320C-X	119
4200-0211N	220	4231N-B103D	221	4263N-B524D	220	5321C-H	120
4200-0212N	220	4231N-B103S	221	4263N-B524DV	220	5321C	120
4200-0213N	220	4231N-B103T	221	4263N-B524S	220	5322C-H	120
4200-0214N	220	4240N-B010	221	4263N-B524SV	220	5322C	120
4200-0215N	220	4240N-B010V	221	430001	224	5324C-H	119
4200N-0017	197, 226	4240N-B020	221	430002	224	5324C	119
4200N-0018	197, 226	4240N-B020V	221	430201V	224	5325C-HX	119
4200N-0020	224	4240N-B121D	221	430201	224	5325C-X	119
4200N-0021	224	4240N-B121S	221	430202V	224	5330C-HX	119
4200N-0023	224	4240N-B122D	221	430202	224	5330C-X	119
4200N-0024	224	4240N-B122S	221	4311-035	102	53702	120
4200N-0025	224	4240N-B123D	221	4302741	223	53703	121
4200N-0026	224	4240N-B123S	221	44J	263	56454132	247
4201N-B102	221	4240N-F110	221	461021-1	243	56454133	247
4201N-B103	221	4240N-F110V	221	461031-1	243	56454134	247
4201N-B104	221	4240N-F120	221	461031-2	243	56454135	247
4211-035	102	4240N-F120V	221	461031-3	243	56454136	247
4214-1502V	218	4240N-F150	221	4621AA11313	242	56454137	247
4214-1503V	218	4240N-F150V	221	4621AA30000	242	56454232	247
4214-1504V	218	4241N-B120U	221	4621AA31414	242	56454233	247
4214-1507V	218	4241N-B121D	220	4621AA41414	242	56454234	247
4214-1508V	218	4241N-B121S	220	4621AA41515	242	56454235	247
4214-2502V	218	4241N-B121T	220	4621BA01313	242	56454236	247
4214-2503V	218	4241N-B122D	220	4621BA11313	242	56454237	247
4214-2504V	218	4241N-B122S	220	4622AA40000	242	56J	263
4214-2507V	218	4241N-B122T	220	4622AA51616	242	626012	259
4214-2508V	218	4241N-B123D	220	4622AA61717	242	626014	259
4221N-B122	219	4241N-B123S	220	4622BA50000-100	242	626320N	259
4221N-B122V	219	4241N-B123T	220	4622BA50000-200	242	626325N	259
4221N-B123	219	4242N-B322D	220	4622BA51616	242	626425N	259
4221N-B123V	219	4242N-B322S	220	4622BA61717	242	626525N	259
4221N-B124	219	4242N-B323D	220	463020	243	626532N	259
4221N-B124V	219	4242N-B323S	220	463051	243	626632N	259
4221N-B127	219	4243N-B322	220	463061	243	626638N	259
4221N-B127V	219	4243N-B322V	220	463080N	243	626651N	259
4221N-B128	219	4243N-B323	220	464622AA51616	242	626751N	259
4221N-B128V	219	4243N-B323V	220	464622AA61717	242	627320N	259
4222N-B322	219	4243N-B324	220	464622BA51616	242	627325N	259
4222N-B323	219	4243N-B324V	220	464622BA61717	242	627420N	259
4222N-B324	219	4243N-B327	220	46463020	243	627425N	259
4223N-B322	219	4243N-B327V	220	46463024	243	627432N	259
4223N-B322V	219	4243N-B328	220	46463051	243	627525N	259

INDEX

Part Number	Page	Part Number	Page	Part Number	Page	Part Number	Page
627532N	259	7F12	260	8007-543-850	99	90B2CMxxE40	192
627632N	259	7F14	260	8007-591-236	99	90B2CMxxE65	192
627638N	259	7F18	260	8007-593-836	99	90B2CMxxE80	192
627751N	259	7F200	260	80112-F-00PP	225	90B2FPx.x	191
64J	263	7F34	260	801-F-00PP	225	90FFB12	248
6500C	72	7F38	260	8020-503-250	98	90FFB14	248
6500N	72	7FC100	260	8020-513-236	98	90FFB18	248
6500XL	72	7FC112	260	8020-833-238	98	90FFB38	248
65-BS205	145, 167, 197	7FC12	260	8027	225, 259	90FFL12	248
65-VBS205	197	7FC14	260	8030-813-239	96	90FFL14	248
65MN011X1.3	198	7FC200	260	8030-863-239	98	90FFL18	248
65VBS0113-13	198	7FC300	260	8034-F-00PP	225	90FFL38	248
65VBS0182-17	223	7FC34	260	8050-305-426	105	90FMB12	248
6JM	263	7LL100	260	8090-212-246	98	90FMB14	248
6J	263	7LL112	260	8090-801-278	98	90FMB38	248
70Q2738	223	7LL114	260	8090-802-289	98	90FML12	248
7100112	260	7LL12	260	8090-902-278	98	90FML14	248
7100400	260	7LL14	260	8095-902-260	98	90FML38	248
7112134	260	7LL200	260	8304B-HM5C	132	9202C	14
7114158	260	7LL300	260	8304BV-HM5C	132	9202S-R	14
712112	260	7RB10012	260	8304BV	132	9202S	14
712118	260	7RB10034	260	8304B	132	9203C-R	15
712200	260	7RB1214	260	8630001	243	9203C-R-SP	16
714112	260	7RB1238	260	8630011	243	9203C-SP	16
7141200	260	7RB1418	260	8630020S	243	9203C	15
714300	260	7RB200112	260	8630024S	243	9203P-S	22
714400	260	7RB3412	260	8630D24S	243	9203P-SR	22
714600	260	7RB3414	260	8-005-01	106	9203S-R	15
7200200	260	7RB3814	260	8-006-01	106	9203S-SP	16
7200212	260	7SE100	260	8-007-01	106	9203S	15
7200300	260	7SE112	260	8-126-00	106	9205C-BSP	19
7200312	260	7SE114	260	8-145-00	106	9205C-SP	19
7200400	260	7SE12	260	8-150-01	106	9205C	18
7200500	260	7SE14	260	8-205-00	106	9206C	20
7200600	260	7SE200	260	8-727-00	109	9206S	20
734138	260	7SE300	260	8JM	263	9208C	21
734400	260	7SE34	260	8J	263	9213P	23
738100	260	7SE38	260	90029	11	9232C-SP	65
738112	260	7TT100	260	9006C-0	11	9233C-SP	65
7433-2502	222	7TT112	260	9006C-0-SP	12	9243P-SP	64
7433-2503	222	7TT114	260	9006P-0	13	9260P-R	24
7433-2515	222	7TT12	260	9008C-0	11	9260P	24
7433-2525	222	7TT14	260	9008P-0	13	9262C-C	25
7433-2535	222	7TT200	260	9016C-0	11	9262S-C	25
7433-2545	222	7TT34	260	9016C-0-SP	12	9262S-CR	25
7433-2601	222	8000-0003	124	9016P-0	13	9263C-BT	27
7433-2608	222	8000-0007	122	9018C-0	11	9263C-C	27
7433-2610	222	8000-0008	122	9018P-0	13	9263C-CR	27
7433-2613	222	8000-0010	124	9028C-0	11	9263C-CR-SP	26
7433-3314	222	8000-0015	124	9028C-0-SP	12	9263C-CR-SP-B	26
7433-3316	222	8000-0017	124	902-100	103	9263C-C-SP	26
7560C-GM15	73	8000-0018	124	902-200	103	9263S-C	27
7560C-GM30	73	8000-0021	124	90-HBF	248	9263S-CR	27
7560C	72	8000-0043	124	90A1CMxxE00	192	9263S-C-SP	26
7560N-GM15	73	8000-0056	92	90A1CMxxE25	192	9302C-HM1C	28
7560N-GM30	73	8000-343-236	96	90A1CMxxE40	192	9302C-HM2C	28
7560N	72	8000-533-236	98	90A1CMxxE65	192	9302C-HM4C	28
7560XL-GM15	73	8000-533-250	98	90A1CMxxE80	192	9302CT-GM1	28
7560XL-GM30	73	8000-541-236	96	90A1FPx.x	191	9302S-HM1C	28
7560XL	72	8000-542-136	96	90A2CMxxE00	192	9302S-HM2C	28
7700C	74	8000-543-136	96	90A2CMxxE25	192	9302S-HM4C	28
7700N	74	8000-543-138	96	90A2CMxxE40	192	9302ST-GM1	28
7700XL	74	8000-543-210	97	90A2CMxxE65	192	9303C-HM1C	30
78-100	248	8000-543-220	97	90A2CMxxE80	192	9303C-HM1C-SP	34
78-112	248	8000-543-236	96	90A2FPx.x	191	9303C-HM2C	30
78-114	248	8000-543-238	96	90B1CMxxE00	192	9303C-HM2C-SP	34
78-12	248	8000-543-250	97	90B1CMxxE25	192	9303C-HM3C	30
78-14	248	8000-543-290	97	90B1CMxxE40	192	9303C-HM3C-SP	34
78-200	248	8000-543-936	96	90B1CMxxE65	192	9303C-HM4C	30
78-300	248	8000-547-189	96	90B1CMxxE80	192	9303C-HM4C-SP	34
78-34	248	8000-643-236	96	90B1FPx.x	191	9303C-HM5C	30
78-38	248	8006-543-250	97	90B2CMxxE00	192	9303C-HM5C-SP	34
7F100	260	8007-543-836	99	90B2CMxxE25	192	9303P-HM1C	36

INDEX

Part Number	Page	Part Number	Page	Part Number	Page	Part Number	Page
9303P-HM2C	36	9316C3U-M10	44	9910-BMH50	93	9910-KIT1916	91
9303P-HM3C	36	9316C3U-M16	44	9910-D1064	85	9910-KIT1917	91
9303P-HM4C	36	9316S3U-M08	44	9910-D1064GRGI	85	9910-KIT1919	91
9303P-HM5C	36	9316S3U-M10	44	9910-D115	80	9910-KIT1920	91
9303S-HM1C	30	9316S3U-M16	44	9910-D115GR34	80	9910-KIT1963	91
9303S-HM1C-SP	34	9325-043-101	103	9910-D135	81	9910-KIT1964	91
9303S-HM2C	30	9342P-HM1C-5SP	63	9910-D160	81	9910-KIT1965	91
9303S-HM2C-SP	34	9342P-HM1C-5USP	63	9910-D250	82	9910-KIT1972	91
9303S-HM3C	30	9342P-HM5C-5SP	63	9910-D252	82	9910-KIT1984	91
9303S-HM3C-SP	34	9342P-HM5C-5USP	63	9910-D252GRGI	82	9910-KIT1987	91
9303S-HM4C	30	9342PV-HM1C-5SP	63	9910-D252GRGI58	82	9910-KIT1990	93
9303S-HM4C-SP	34	9342PV-HM5C-5SP	63	9910-D252GRGIAP	82	9910-KIT1992	91
9303S-HM5C	30	9343P-GM10-SP	63	9910-D30	83	9910-KIT2024	91
9303S-HM5C-SP	34	9343P-GM10Y-SP	63	9910-D30AP-A	83	9910-KIT2026	91
9305C-HM3C	38	9343P-GM6-SP	63	9910-D30-B-GRGI	83	9910-KIT2053	91
9305C-HM3C-BSP	39	9343P-GM6Y-SP	63	9910-D30GRGI	83	9910-KIT2100	91
9305C-HM3C-SP	39	9343P-GM6Y-SP-001	63	9910-D403	83	9910-KIT2110	91
9306C-HM1C	40	9402C-1000	50	9910-D403GRGI	83	9910-KIT2111	91
9306C-HM1C-3U	41	9402C-1000L	50	9910-D50	84	9910-KIT2113	91
9306C-HM3C	40	9402C-1000S	50	9910-D503	84	9910-KIT2114	91
9306C-HM3C-3U	41	9402C-540	50	9910-D503GRGI	84	9910-KIT2200	91
9306C-HM5C	40	9402C-540Q	50	9910-D503GRGI34	84	9910-KIT2201	91
9306C-HM5C-3U	41	9402C-540S	50	9910-D50AP-A	84	9910-KIT2202	91
9306S-HM1C	40	9403C-1000	50	9910-D50-B	84	9910-KIT2203	91
9306S-HM1C-3U	41	9403C-1000L	50	9910-D70	80	9910-KIT2204	91
9306S-HM3C	40	9403C-1000L-SP	49	9910-D70GR	80	9910-KIT2347	91
9306S-HM3C-3U	41	9403C-1000-MTZ	50	9910-D813	85	9910-KIT2349	91
9306S-HM5C	40	9403C-1000-MTZ-KIT	50	9910-D813GRGI	85	9910-KIT2364	91
9306S-HM5C-3U	41	9403C-1000S	50	9910-DBA110	86	9910-KIT2365	91
9307C-GM10	46	9403C-1000-SP	49	9910-DBA140	86	9910-KIT2370	91
9307C-GM12	46	9403C-540	50	9910-DBA160	87	9910-KIT2374	91
9307CWS-GM12	47	9403C-540Q	50	9910-DBA200	87	9910-KIT2376	91
9307CWS-GM12-002	47	9403C-540Q-SP	49	9910-DBS110	86	9910-KIT2378	91
9307CWS-GM12-004	47	9403C-540S	50	9910-DBS140	86	9910-KIT2388	91
9307CWS-GM12-005	47	9403C-540-SP	49	9910-DBS160	87	9910-KIT2389	91
9307CWS-GM12-006	47	9403C-540S-SP	49	9910-DBS200	87	9910-KIT2408	91
9307CX	46	9403P-1000	50	9910-DP423	79	9910-KIT2409	91
9308C-GM25	48	9403P-1000L	50	9910-DP423GRGI	79	9910-KIT2423	91
9308C-PM15	48	9403P-1000S	50	9910-DP573	79	9910-KIT2444	91
9308CX	48	9403P-540	50	9910-DP573GRGI	79	9910-KIT2445	91
9313C-M04	32	9403P-540Q	50	9910-DP763	79	9910-KIT2446	91
9313C-M05	32	9403P-540S	50	9910-DP763GRGI	79	9910-KIT2456	91
9313C-M08	32	9403S-1000	50	9910-GH50	93	9910-KIT2457	91
9313C-M10	32	9403S-1000L	50	9910-GR40	93	9910-KIT2479	91
9313C-M16	32	9403S-1000S	50	9910-GS25	79, 93	9910-KIT2480	91
9313CU-M04	32	9403S-540	50	9910-GS35S	79, 93	9910-KIT55375	92
9313CU-M05	32	9403S-540Q	50	9910-GS40GI	93	9910-RM40	93
9313CU-M08	32	9403S-540S	50	9910-GS50GI	93	9910-VDR50	93
9313CU-M10	32	94-389-00	102	9910-HYD1570	92	9920-248	238
9313CU-M16	32	94-389-01	102	9910-HYD2495	92	9920-261703-69	237
9313S-M04	32	94-712-00	109	9910-HYD5312	92	9920-35.1703.67	237
9313S-M05	32	94-716-00	109	9910-KIT1640	92	9920-35.1802.56	237
9313S-M08	32	94-717-00	109	9910-KIT1642	92	9920-KIT10/11	238
9313S-M10	32	94-718-00	109	9910-KIT1702	91	9940-9750NRL	131
9313S-M16	32	94-719-00	109	9910-KIT1703	91	9940-9751NRL	131
9313SU-M04	32	94-720-00	109	9910-KIT1704	91	9940-9753NRL	131
9313SU-M05	32	94-720-05	109	9910-KIT1706	91	9950-0001	162
9313SU-M08	32	94-721-00	109	9910-KIT1707	91	9950-0022	199
9313SU-M10	32	94-723-00	109	9910-KIT1708	91	9950-0023	199
9313SU-M16	32	94-724-00	109	9910-KIT1710	91	9950-0024	197, 226
9314C-M08	42	94-725-00	109	9910-KIT1711	91	9950-0027	197, 226
9314C-M10	42	94-732-00	109	9910-KIT1720	91	9950-0028	199
9314C-M16	42	94-733-00	109	9910-KIT1721	91	9950-0031	199
9314CU-M08	42	94-734-00	109	9910-KIT1722	91	9950-0033	187
9314CU-M10	42	94-735-00	109	9910-KIT1723	91	9950-075BA	253
9314CU-M16	42	94-736-00	109	9910-KIT1724	91	9950-075BB	253
9314S-M08	42	94-737-00	109	9910-KIT1725	91	9950-075BD	254
9314S-M10	42	94-738-00	109	9910-KIT1730	91	9950-075BF	254
9314S-M16	42	9700B	133	9910-KIT1734	91	9950-075C	253
9314SU-M08	42	9700S	133	9910-KIT1881	91	9950-075E	254
9314SU-M10	42	9742P-050SPT	64	9910-KIT1882	91	9950-075G	254
9314SU-M16	42	9742P-050SPT3	64	9910-KIT1904	91	9950-075H	254
9316C3U-M08	44	9742P-075SPT3	64	9910-KIT1908	91	9950-075NA	253

INDEX

Part Number	Page	Part Number	Page	Part Number	Page	Part Number	Page
9950-075NB	253	9951-2050N	247	A14516	256	AMT-15007	169
9950-075ND	254	9951-2075B	247	A14B	261	AMT-15008	169
9950-075NF	254	9951-2075N	247	A14S	261	AMT-15010	169, 237
9950-08050	230	9951-2100B	247	A14	256	AMT-15012	169, 237
9950-08120	230	9951-2100N	247	A1814B	261	AMT-15015	169, 237
9950-08240	230	9951-2100UF	252	A1814S	261	AMT-15018	169, 237
9950-100BA	253	9951-2125B	247	A1814	256	AMT-15020	169, 237
9950-100BB	253	9951-2125N	247	A18316	256	AMT-15023	169, 237
9950-100BD	254	9951-2150B	247	A1838B	261	ASG1604	250
9950-100BF	254	9951-2150N	247	A1838S	261	ASG160	250
9950-100C	253	9951-2200B	247	A1838	256	ASG4004	250
9950-100E	254	9951-2200N	247	A18516	256	ASG400	250
9950-100G	254	9951-2200UF	252	A200	256	ASG604	250
9950-100H	254	9951-2300UF	252	A34100B	261	ASG60	250
9950-100NA	253	9951-3050B	247	A34100S	261	ATR-BLACK	175
9950-100NB	253	9951-3050N	247	A34100	256	ATR-BLUE	175
9950-100ND	254	9951-3075B	247	A3412B	261	ATR-BROWN	175
9950-100NF	254	9951-3075N	247	A3412S	261	ATR-GRAY	175
9950-12060	230	9951-3100B	247	A3412	256	ATR-GREEN	175
9950-12240	230	9951-3100N	247	A3414	256	ATR-LILAC	175
9950-125BA	253	9951-3125B	247	A3438B	261	ATR-ORANGE	175
9950-125BB	253	9951-3125N	247	A3438S	261	ATR-RED	175
9950-125BD	254	9951-3150B	247	A3438	256	ATR-WHITE	175
9950-125BF	254	9951-3150N	247	A3458B	261	ATR-YELLOW	175
9950-125C	253	9951-3200B	247	A3458S	261	ATW-11001	157
9950-125E	254	9951-3200N	247	A3458	256	ATW-110015	157
9950-125G	254	9A100	260	A34B	261	ATW-11002	157
9950-125H	254	9A112	260	A34S	261	ATW-11003	157
9950-125NA	253	9A114	260	A34	256	ATW-11004	157
9950-125NB	253	9A12	260	A3812B	261	ATW-11005	157
9950-125ND	254	9A1412	260	A3812S	261	AVI-11001	159
9950-125NF	254	9A1438	260	A3812	256	AVI-110015	159
9950-150BA	253	9A14	260	A3814B	261	AVI-11002	159
9950-150BB	253	9A200	260	A3814S	261	AVI-110025	159
9950-150BD	254	9A300	260	A3814	256	AVI-11003	159
9950-150BF	254	9A34	260	A38516	256	AVI-11004	159
9950-150C	253	9A3812	260	A3858	256	AVI-11005	159
9950-150E	254	9A38	260	A38B	261	AVI-11006	159
9950-150G	254	A100114	256	A38S	261	AVI-11008	159
9950-150H	254	A10034	256	A38	256	AVI-11010	159
9950-150NA	253	A100B	261	A-100SS	253	AVI-8001	177
9950-150NB	253	A100S	261	A-150SS	253	AVI-80015	177
9950-150ND	254	A100	256	A-200SS	253	AVI-8002	177
9950-150NF	254	A112114	256	A-300SS	253	AVI-80025	177
9950-16180	230	A112	256	A-750SS	253	AVI-8003	177
9950-16280	230	A114100	256	AA10034P	261	AVI-8004	177
9950-16320	230	A114112	256	AA100P	261	AVI-OC-80015	185
9950-200BA	253	A11434	256	AA112P	261	AVI-OC-8002	185
9950-200BB	253	A114	256	AA114P	261	AVI-OC-80025	185
9950-200BD	254	A12100	256	AA200P	261	AVI-OC-8003	185
9950-200BF	254	A1214B	261	AA34P	261	AVI-OC-8004	185
9950-200C	253	A1214S	261	ADI-11001	160	AXI-110015	161
9950-200E	254	A1214	256	ADI-110015	160	AXI-11002	161
9950-200G	254	A12316	256	ADI-11002	160	AXI-110025	161
9950-200H	254	A1234B	261	ADI-11003	160	AXI-11003	161
9950-200NA	253	A1234S	261	ADI-11004	160	AXI-11004	161
9950-200NB	253	A1234	256	AE2650	242	AXI-11005	161
9950-200ND	254	A1238B	261	AE2652	242	AXI-11006	161
9950-200NF	254	A1238S	261	AE2654	242	AXI-80015	161, 178
9950-300BA	253	A1238	256	AF1214	256	AXI-8002	161, 178
9950-300BB	253	A1258B	261	AF1234	256	AXI-8003	161, 178
9950-300BD	254	A1258S	261	AF1238	256	AXI-8004	161, 178
9950-300BF	254	A1258	256	AF1258	256	AXI-8005	161, 178
9950-300C	253	A12B	261	AF12	256	AXI-8006	161, 178
9950-300E	254	A12S	261	AF1438B	261	B100	259
9950-300G	254	A12	256	AF1438	256	B12	225, 259
9950-300H	254	A1412B	261	AF14	256	B301AB	250
9950-300NA	253	A1412S	261	AF3412	256	B33B	262
9950-300NB	253	A1412	256	AF3438	256	B3412	259
9950-300ND	254	A14316	256	AF34	256	B34B	262
9950-300NF	254	A1438B	261	AF3812	256	B34	259
9950-55203	230	A1438S	261	AF3814	256	B35S	261
9951-2050B	247	A1438	256	AF38	256	B35	259

INDEX

Part Number	Page	Part Number	Page	Part Number	Page	Part Number	Page
B-100SS	253	CAP00-04	151, 155, 160, 182, 184, 197	CS301AFD1.2-105	194	E-750SS	254
B-150SS	253			CS301MNF-W	194	EL10012	256
B-200SS	253	CAP00-05	151, 155, 182, 197	D252GRGI-120H	88	EL10034	256
B-300SS	253	CAP00-06	151, 155, 182, 197	D252GRGI-25	88	EL100HB	257
B-750SS	253	CAP00-08	151, 155, 182, 197	D252GRGI-55	88	EL100	256
BC100R	226	CAP00-10	155, 197	D30GRGI-160EH	88	EL112HB	257
BC100	226	CAP00-15	155, 197	D30GRGI-160H	88	EL112	256
BC114	226	CAP00-20	155, 183, 197	D30GRGI-65	88	EL114100	256
BC34R	226	CAP01-01	157, 177, 197	D30HRGI	83, 88	EL114112	256
BG-2910-0026	222	CAP01-015	157, 177, 185, 197	D30HRGI-160EH	88	EL11434	256
BG-3430-0790	222	CAP01-02	157, 177, 185, 197	D30HRGI-160H	88	EL114HB	257
BG-400275N	226	CAP01-025	177, 184, 197	D30HRGI-65	88	EL114	256
BG-4200-0060	197	CAP01-03	157, 177, 185, 197	D30HRGI-65E	88	EL12100	256
BG-4200-0061	197	CAP01-04	157, 177, 185, 197	D34100	258	EL1214HB	257
BG-4200-0062	197	CAP01-05	157, 197	D3412B	262	EL1214	256
BG-4200-0063	197	CAP01-06	197	D3412	258	EL1234F	256
BG-4200-0082	197	CAP01-08	197	D3414	258	EL1234	256
BG-4200-0083	197	CAP01-10	197	D3438B	262	EL1238HB	257
BG-4223N-B324L	219	CAP01-15	197	D3438	258	EL1238	256
BG-4223N-B324VL	219	CAP01-20	197	D3458B	262	EL1258F	256
BG-4223N-B524L	219	CAP04-01	197	D3458	258	EL1258	256
BG-4223N-B524VL	219	CAP04-015	197	D34B	262	EL12HB	257
BG-4247N-B111	221	CAP04-02	181, 197	D34	258	EL12	256
BG-4247N-B119	221	CAP04-025	197	D403GRGI-65	89	EL1412	256
BG-4247N-B121	221	CAP04-03	181, 197	D403HRGI	89	EL1438F	256
BG-4247N-B129	221	CAP04-04	181, 197	D403HRGI-65	89	EL1438	256
BG-4247N-C111	221	CAP04-05	181, 197	D403HRGI-65E	89	EL14516	256
BG-4247N-C119	221	CAP04-06	181, 197	D503GRGI-160EH	90	EL1458	256
BG-4247N-C121	221	CAP04-08	197	D503GRGI-160H	90	EL14F	256
BG-4247N-C129	221	CAP04-10	197	D503HRGI	90	EL14HB	257
BG-7433-2502	222	CAP04-15	197	D503HRGI-65	90	EL14	256
BG-7433-2503	222	CAP04-20	174, 197	D503HRGI-65E	90	EL1814	256
BG-7433-2515	222	CAP05-01	197	D50GRGI-160EH	89	EL18316	256
BG-7433-2525	222	CAP05-015	197	D50GRGI-160H	89	EL1838	256
BG-7433-2535	222	CAP05-02	197	D-100SS	254	EL18516	256
BG-7433-2545	222	CAP05-025	197	D-150SS	254	EL200HB	257
BG-7433-2601	222	CAP05-03	197	D-200SS	254	EL200	256
BG-7433-2608	222	CAP05-04	197	D-300SS	254	EL34100	256
BG-7433-2610	222	CAP05-05	197	D-750SS	254	EL3412F	256
BG-7433-2613	222	CAP05-06	197	DC-100SS	254	EL3412	256
BG-7433-3314	222	CAP05-08	197	DC-150SS	254	EL3414	256
BG-7433-3316	222	CAP05-20	173, 175, 176, 179, 197	DC-200SS	254	EL3438	256
BG-UFC0100E-A-S	251	CAP09-20	197	DC-300SS	254	EL3458F	256
BG-UFC0150E-A-S	251	CAP10-20	197	DC-750SS	254	EL3458HB	257
BG-UFC0200E-A-S	251	CAP11-01	197	DCC-01	173, 179	EL3458	256
BG-UFC0300E-A-S	251	CAP11-015	197	DCC-02	173, 179	EL34F	256
C100	259	CAP11-02	197	DCC-03	173, 179	EL34HB	257
C12B	262	CAP11-025	197	DCC-04	173, 179	EL34	256
C12NPT	259	CAP11-03	197	DCC-05	173, 179	EL3812F	256
C12S	261	CAP11-035	197	DCC-06	173, 179	EL3812	256
C12	259	CAP11-04	197	DCC-07	173, 179	EL3814F	256
C14	259	CAP11-05	197	DP-100SS	254	EL3814HB	257
C34B	262	CAP11-06	197	DP-150SS	254	EL3814	256
C34S	261	CAP11-08	197	DP-200SS	254	EL38516	256
C34	259	CAP11-10	197	DP-300SS	254	EL3858	256
C38B	262	CAP11-15	197	DP-750SS	254	EL38F	256
C38	259	CAP11-20	197	E3412B	262	EL38HB	257
C58B	262	CAP30-20	165, 196, 197	E3412	285, 259	EL38	256
C58	259	CAP-EXT-BAG10	197	E3438	258	EL58HB	257
C-100SS	253	CN32-0001	214, 223	E34B	262	ELD3412	258
C-150SS	253	CPV007	226	E34	258, 259	ELD3414	258
C-200SS	253	CRC-13	173	E80-015	182, 195	ELD3438	258
C-300SS	253	CRC-23	173	E80-01	182, 195	ELD3458	258
C-750SS	253	CRC-31	179	E80-02	182, 195	ELD34	258
CAP00-01	155, 160, 182, 195, 197	CRC-35	179	E80-03	182, 195	ESI-110015	167
CAP00-015	151, 155, 160, 182, 195, 197	CRC-45	173	E80-04	182	ESI-11002	167
		CRC-46	173	E80-05	182	ESI-110025	167
CAP00-02	151, 155, 160, 182, 184, 195, 197	CRC-56	179	E80-06	182	ESI-11003	167
		CS301AF0.4-65	194	E80-08	182	ESI-11004	167
CAP00-025	151, 197	CS301AF0.7-80	194	E-100SS	254	ESI-11005	167
CAP00-03	151, 155, 160, 182, 184, 195, 197	CS301AF1.2-105C	194	E-150SS	254	ESI-11006	167
		CS301AF1.6-100	194	E-200SS	254	F100	257
CAP00-035	197	CS301AFD0.7-80	194	E-300SS	254	F110-01	155

INDEX

Part Number	Page	Part Number	Page	Part Number	Page	Part Number	Page
F110-015	155	FC-AXI-8002	161, 178	FNAS-10034	253	GTT3414	257
F110-02	155	FC-AXI-8003	161, 178	FNAS-112100	253	H34	258
F110-03	155	FC-AXI-8004	161, 178	FNAS-112112	253	HF140-08	163
F110-04	155	FC-AXI-8005	161, 178	FNAS-112114	253	HF140-10	163
F110-05	155	FC-AXI-8006	161, 178	FNAS-114100	253	HF140-15	163
F110-06	155	FC-ESI-110015	167	FNAS-114114	253	HF140-20	163
F110-08	155	FC-ESI-110015P	167	FNAS-1212	253	HF140-30	163
F110-10	155	FC-ESI-11002	167	FNAS-200200	253	HF140-40	163
F110-15	155	FC-ESI-110025	167	FNAS-3412	253	HF140-50	163
F110-20	155	FC-ESI-11002P	167	FNAS-3434	253	HF140-60	163
F112	257	FC-ESI-11003	167	FNAS-3458	253	HM1214	258
F114	257	FC-ESI-11003P	167	FNCAP-100	253	HM1238	258
F12B	262	FC-ESI-11004	167	FNCAP-100N	130	HM14316	258
F12	257	FC-ESI-11004P	167	FNE-100100	130	HM14	258
F14B	262	FC-ESI-11005	167	FNE-10034	130	HM18	258
F14	257	FC-ESI-11005P	167	FNS-100100	130	HM3814	258
F18	257	FC-ESI-11006	167	FNS-10012	130	HM516	258
F200	257	FC-ESI-11006P	167	FNS-10034	130	HM5838	258
F34	257	FC-ESI-11008	167	G3412	258	HM58	258
F38B	262	FC-ESI-11010	167	G3414	258	HP1/4-00xx	190
F38	257	FC-ESI-11015	167	G34	258	HP1/4-05xx	190
F65-005	193	FC-ESI-11020P	167	G40004	231	HP1/4-15xx	190
F80-0067	155, 193	FC-GA110-015	147	GA110-015	147	HP1/4-25xx	190
F80-015	155	FC-GA110-02	147	GA110-02	147	HP1/4-40xx	190
F80-01	155	FC-GA110-025	147	GA110-025	147	HP1/8-00xx	190
F80-02	155	FC-GA110-03	147	GA110-03	147	HP1/8-05xx	190
F80-03	155	FC-GA110-035	147	GA110-035	147	HP1/8-15xx	190
F80-04	155	FC-GA110-04	147	GA110-04	147	HP1/8-25xx	190
F80-05	155	FC-GA110-05	147	GA110-05	147	HP1/8-40xx	190
F80-06	155	FC-ULD120-015	141	GAT110-02	145	I34	259
F80-08	155	FC-ULD120-02	141	GAT110-025	145	J3412	258
F80-10	155	FC-ULD120-025	141	GAT110-025A	145	K8412	225
F80-15	155	FC-ULD120-03	141	GAT110-02A	145	K8414	225
F80-20	155	FC-ULD120-04	141	GAT110-03	145	K8438	225
F-100SS	254	FC-ULD120-05	141	GAT110-035	145	LA24	247
F-150SS	254	FC-ULD120-06	141	GAT110-035A	145	LA5	247
F-200SS	254	FC-ULD120-08	141	GAT110-03A	145	LD110-015	151
F-300SS	254	FC-VP110-015	153	GAT110-04	145	LD110-02	151
F-750SS	254	FC-VP110-02	153	GAT110-04A	145	LD110-025	151
FC100	257	FC-VP110-025	153	GAT110-05	145	LD110-03	151
FC112	257	FC-VP110-03	153	GAT110-05A	145	LD110-04	151
FC114	257	FC-VP110-035	153	GAT110-06	145	LD110-05	151
FC12B	262	FC-VP110-04	153	GAT110-06A	145	LD110-06	151
FC12	257	FC-VP110-05	153	GAT110-08	145	LD110-08	151
FC14B	262	FC-VP110-06	153	GAT110-08A	145	LD80-015	151
FC200	257	FC-VP110-08	153	GG10000	249	LD80-02	151
FC34	257	FC-VP110-10	153	GG1000	249	LD80-03	151
FC-3D100-015	143	FC-VP110-15	153	GG1004	249	LD80-04	151
FC-3D100-02	143	FC-VP80-015	153	GG100	249	LD80-05	151
FC-3D100-025	143	FC-VP80-02	153	GG15000	249	LD80-06	151
FC-3D100-03	143	FC-VP80-03	153	GG1500	249	LD80-08	151
FC-3D100-035	143	FC-VP80-04	153	GG160	249	LL100	257
FC-3D100-04	143	FC-VP80-05	153	GG2000	249	LL112	257
FC-3D100-05	143	FC-VP80-06	153	GG200	249	LL114	257
FC-3D100-06	143	FC-XT010	187	GG3000	249	LL12	257
FC-3D100-08	143	FC-XT020	187	GG300	249	LL14B	262
FC-AVI-11001	159	FC-XT024	187	GG30	249	LL18B	262
FC-AVI-110015	159	FC-XT043	187	GG4000	249	LL200	257
FC-AVI-11002	159	FM-1100	108	GG400	249	LL34	257
FC-AVI-110025	159	FM-1100i	108	GG5000	249	LT2	263
FC-AVI-11003	159	FNAE-100100	253	GG6000	249	LT4	263
FC-AVI-11004	159	FNAE-10034	253	GG600	249	LT8	263
FC-AVI-11005	159	FNAE-112100	253	GG604	249	M100	257
FC-AVI-11006	159	FNAE-112112	253	GG60	249	M112	257
FC-AVI-11008	159	FNAE-112114	253	GRD120-015	149	M114	257
FC-AVI-11010	159	FNAE-114100	253	GRD120-02	149	M1214	257
FC-AXI-110015	161	FNAE-114114	253	GRD120-025	149	M1218	257
FC-AXI-11002	161	FNAE-200200	253	GRD120-03	149	M1238	257
FC-AXI-11003	161	FNAE-3412	253	GRD120-04	149	M12	257
FC-AXI-11004	161	FNAE-3434	253	GRD120-05	149	M1418	257
FC-AXI-11005	161	FNAE-3458	253	GRD120-06	149	M14	257
FC-AXI-11006	161	FNAS-100100	253	GRD120-08	149	M18	257
FC-AXI-80015	161, 178	FNAS-10012	253	GTT1214	257	M200	257

INDEX

Part Number	Page	Part Number	Page	Part Number	Page	Part Number	Page
M3412	257	RB1238	257	SG602	249	TL12-0013	228
M3438	257	RB1418B	262	SG604	249	TL12-0014	228
M34	257	RB200100	257	SG60	249	TL16-0001	228
M3814	257	RB200112	257	SHM100	258	TL16-0002	228
M3818	257	RB200114	257	SHM112	258	TL16-0003	228
M38	257	RB20034	257	SHM114	258	TL16-0006	228
MF1814B	250	RB300200	257	SHM1238	258	TL16-0007	228
N34	259	RB3412B	262	SHM1258	258	TL16-0011	228
NB1612	225	RB3412	257	SHM12B	261	TL16-0012	228
NB1614	225	RB3414	257	SHM12	258	TL16-0013	228
NBC10	225	RB3418	257	SHM14B	261	TL16-0014	228
NC1214	259	RB3438	257	SHM14	258	TLP-0007	228
NC12N	259	RB3814	257	SHM200	258	TLP-0018	228
NC12	259	RB3818	257	SHM34B	261	TLP-0023	228
NC14N	259	RI167	248	SHM34	258	TLP-0046	229
NC14	259	RW1116A	259	SHM38B	261	TLP-0050	229
NC38N	259	RW1116B	259	SHM38	258	TS01-100	198
NC38	259	RW1116C	259	SHM58B	261	TS01-50	141, 143, 198
NF1614	225	RW1116D	259	SHM58	258	TS02-100	149, 198
NS12	263	SA12B	262	SLV10-AA40	104	TS02-50	145, 149, 198
NS17	263	SA38B	262	SLV10-AA41	104	TS03-25	198
NS21	263	SE100	256	SLV10-AA48	104	TT100	257
NS28	263	SE112	256	SLV10-AB41	104	TT112	257
NS32	263	SE114	256	SLV10-HA01	104	TT114	257
NS4	263	SE12B	261	T100	258	TT12	257
NS7	263	SE12	256	T112	258	TT14	257
NS8	263	SE1445	257	T114	258	TT200	257
NTL12	225	SE14B	261	T1234T	258	TT34	257
NTL14	225	SE14	256	T1238T	258	TUR324B-x.x	188
NTL34	225	SE200	256	T1238	258	TUR324B-x.x-BSP	188
NTL38	225	SE3445	257	T1258T	258	TUR324S-x.x	188
NTL58	225	SE34	256	T12C	225	TUR330B-x.x	188
NTT12	225	SE38B	261	T12T	258	TUR330S-x.x	188
NTT34	225	SE38	256	T12	258	TVI-80005	176
NTT38	225	SF-1100	108	T1412T	258	TVI-800075	176
NTT58	225	SF-1100-110V	108	T1438T	258	TVI-80015	176
OCI-8002	184	SF-1100-PTS	107	T1438	258	TVI-8002	176
OCI-8003	184	SF-1100-PTSi	107	T14T	258	TVI-80025	176
OCI-8004	184	SF-1100-PTSi-00	107	T14	258	TVI-8003	176
PC1/2F-235120	230	SF-1100-REC-DT	107	T1814T	258	UF100-FN025P	252
PC1/2F-36075	230	SF-1105	108	T18	258	UF100-FN100	252
PC1/2F-36075-PV	230	SF-1105-PTS	107	T200	258	UF100-HB075	252
PK-4223N-B323VPSE	214	SF-1105-PTSi	107	T34100T	258	UF100-HB100	252
PK-4223N-B324VPSE	214	SF-1105-REC	107	T3412T	258	UF100-HB125	252
PK-4223N-B324VPSE	214	SG1000	249	T3412	258	UF100-HBT100	252
PK-4223N-B523PSE	214	SG1001.58C	249	T34C	225	UF100-MN075	252
PK-4223N-B524PSE	214	SG1002C	249	T34F	258	UF100-MN100	252
PK-4223N-B524PSE	214	SG1002	249	T34T	258	UF100-MN125	252
PK-4223N-B524VPSE	214	SG1004	249	T34	258	UF100L-HB075	252
PK-4223N-B527PSE	214	SG100	249	T3812T	106, 258	UF100L-HB100	252
PK-4223N-B528PSE	214	SG152	249	T3812	258	UF100L-HB125	252
PK-4223N-B528PSE	214	SG15	249	T3814T	258	UF100L	251
PP301AF0.4-65	194	SG1601.58C	249	T3858	258	UF100P	252
PP301AF0.7-80	194	SG1602C	249	T38C	225	UF100T	251
PP301AF0.7-80W	194	SG1602	249	T38T	258	UF100X	252
PP301AF1.2-105C	194	SG160	249	T38	258	UF100	251
PP301AF1.6-100	194	SG2000	249	T58	258	UF200-FN200	252
PS3/4F-PN	223	SG2001.58C	249	TL06-0003	227	UF200-HB150	252
PV1/2F1/2M-MA	230	SG2002C	249	TL06-0004	227	UF200-HB200	252
Q12	259	SG2002	249	TL08-0001	228	UF200-MA200	252
Q14	259	SG2004	249	TL08-0002	228	UF200-MN200	252
QT14-1-NDC	221	SG200	249	TL08-0003	228	UF200-RC100	252
RB10012	257	SG3000	249	TL08-0011	228	UF200L-HB150	252
RB10034	257	SG3002C	249	TL08-0012	228	UF200L-HB200	252
RB112100	257	SG3002	249	TL08-0013	228	UF200L	251
RB112114	257	SG300	249	TL08-0014	228	UF200P	252
RB11234	257	SG302	249	TL12-0001	228	UF200T	251
RB114100	257	SG30	249	TL12-0002	228	UF200X	252
RB11434	257	SG400	249	TL12-0003	228	UF200	251
RB1214B	262	SG5000	249	TL12-0006	228	UF300-HB200	252
RB1214	257	SG600	249	TL12-0007	228	UF300-HB300	252
RB1218	257	SG601.58C	249	TL12-0011	228	UF300-MA300	252
RB1238B	262	SG602C	249	TL12-0012	228	UF300-MN300	252

INDEX

Part Number	Page	Part Number	Page	Part Number	Page	Part Number	Page
UF300-RC200	252	VGG3030	249	WBH112	231	WGGSS100C	250
UF300L-HB200	252	VGG3060	249	WBH114/112GAS	231	WGGSS160	250
UF300L-HB300	252	VGG30	249	WBH114	231	WGGSS3000	250
UF300L	251	VP110-015	153	WBH12/34GAS	231	WGGSS400	250
UF300P	252	VP110-02	153	WBH12	231	WGGSS400C	250
UF300T	251	VP110-025	153	WBH200GAS	231	WGGSS5000	250
UF300X	252	VP110-03	153	WBH200	231	WGGSS60	250
UF300	251	VP110-035	153	WBH300	231	WGGSS600	250
UFC0100-S	251	VP110-04	153	WBH34	231	XT010-GIOKIT	187
UFC0150-S	251	VP110-05	153	WBH400	231	XT010	187
UFC0200-S	251	VP110-06	153	WGG1000C	249	XT020-GIOKIT	187
UFC0300-S	251	VP110-08	153	WGG100C	249	XT020	187
UFG0100E-A	222, 251	VP110-10	153	WGG1500C	249	XT024-GIOKIT	187
UFG0150E-A	251	VP110-15	153	WGG160C	249	XT024	187
UFG0200E-A	251	VP80-015	153	WGG2000C	249	XT043-GIOKIT	187
UFG0300E-A	251	VP80-02	153	WGG200C	249	XT043	187
ULD120-015	141	VP80-03	153	WGG3000C	249	XT080-GIOKIT	187
ULD120-02	141	VP80-04	153	WGG300C	249	XT080	187
ULD120-025	141	VP80-05	153	WGG400C	249	XT167-GIOKIT	187
ULD120-03	141	VP80-06	153	WGG5000C	249	XT167	187
ULD120-04	141	W160M	259	WGG6000C	249	XT215-GIOKIT	187
ULD120-05	141	W405P	259	WGG600C	249	XT215	187
ULD120-06	141	W406V	259	WGG60C	249	Y01356040	229
ULD120-08	141	WBH100GAS	231	WGGSS100	250	Y01356061	229
VGG30160	249	WBH100	231	WGGSS1000	250		

LIMITED WARRANTY ON HYPRO/SHURFLO AGRICULTURAL PUMPS & ACCESSORIES

Hypro/Shurflo (hereafter, "Hypro") agricultural products are warranted to be free of defects in material and workmanship under normal use for the time periods listed below, with proof of purchase.

- Pumps: one (1) year from the date of manufacture, or one (1) year of use. This limited warranty will not exceed two (2) years, in any event.
- Accessories: ninety (90) days of use.

This limited warranty will not apply to products that were improperly installed, misapplied, damaged, altered, or incompatible with fluids or components not manufactured by Hypro. All warranty considerations are governed by Hypro's written return policy.

Hypro's obligation under this limited warranty policy is limited to the repair or replacement of the product. All returns will be tested per Hypro's factory criteria. Products found not defective (under the terms of this limited warranty) are subject to charges paid by the returnee for the testing and packaging of "tested good" non-warranty returns.

No credit or labor allowances will be given for products returned as defective. Warranty replacement will be shipped on a freight allowed basis. Hypro reserves the right to choose the method of transportation.

This limited warranty is in lieu of all other warranties, expressed or implied, and no other person is authorized to give any other warranty or assume obligation or liability on Hypro's behalf. Hypro shall not be liable for any labor, damage or other expense, nor shall Hypro be liable for any indirect, incidental or consequential damages of any kind incurred by the reason of the use or sale of any defective product.

RETURN PROCEDURES

All products must be flushed of any chemical (ref. OSHA section 1910.1200 (d)(e)(f)(g)(h)) and hazardous chemicals must be labeled/tagged before being shipped* to Hypro for service or warranty consideration. Hypro reserves the right to request a Material Safety Data Sheet from the returnee for any pump/product it deems necessary. Hypro reserves the right to "disposition as scrap" products returned which contain unknown fluids. Hypro reserves the right to charge the returnee for any and all costs incurred for chemical testing, and proper disposal of components containing unknown fluids. Hypro requests this in order to protect the environment and personnel from the hazards of handling unknown fluids.

Be prepared to give Hypro full details of the problem, including the model number, date of purchase, and from whom you purchased your product. Hypro may request additional information, and may require a sketch to illustrate the problem.

Contact the appropriate Hypro Service Department to receive a Return Merchandise Authorization number (RMA#). Returns are to be shipped with the RMA number clearly marked on the outside of the package. Hypro shall not be liable for freight damage incurred during shipping. Please package all returns carefully. All products returned for warranty work should be sent shipping charges prepaid:

AMERICAS

HYPRO / PENTAIR
Attention: Service Department
375 Fifth Avenue NW
New Brighton, MN 55112
Service: 800-468-3428
Fax: 651-766-6618
Technical: 800-445-8360
hypro.technical@pentair.com

EUROPE

HYPRO EU Ltd.
Station Road
Longstanton
Cambridge CB24 3DS UK
Service/Technical:
+44 1954 260097
Fax: +44 1954 260245
euagorders@pentair.com

ALL OTHER REGIONS

HYPRO / PENTAIR
Attention: Service Department
375 Fifth Avenue NW
New Brighton, MN 55112
Service: 800-468-3428
Fax: 651-766-6618
Technical: 800-445-8360
hypro.technical@pentair.com

*Carriers, including U.S.P.S., airlines, UPS, ground freight, etc., require specific identification of any hazardous material being shipped. Failure to do so may result in a substantial fine and/or prison term. Check with your shipping company for specific instructions.



HYPRO®

375 Fifth Avenue NW,
New Brighton, MN 55112, USA
Main: 651-766-6300 | Technical: 800-445-8360
Order: 800-424-9776 | Fax Order: 800-323-6496
hypro.sales@pentair.com

HYPRO® EU LTD.

Station Road, Longstanton,
Cambridge CB24 3DS, UK
+44 1954 260097 Fax: +44 1954 260245
euaginfo@pentair.com
Order: euagorders@pentair.com

CENTRAL & SOUTH AMERICA

+55 (11) 3317-5085
vendas.pwdb@pentair.com

All Pentair trademarks and logos are owned by Pentair, Inc. All other brand or product names are trademarks or registered marks of their respective owners. Because we are continuously improving our products and services, Pentair reserves the right to change specifications without prior notice. Pentair is an equal opportunity employer.

Form HYP01 (Rev B) 7/18 ©2018 Pentair, Inc. All Rights Reserved. Printed in the USA