

CALDWELL COMPANY'S INSTALLATION BLUEPRINT

A Brand You Can Trust

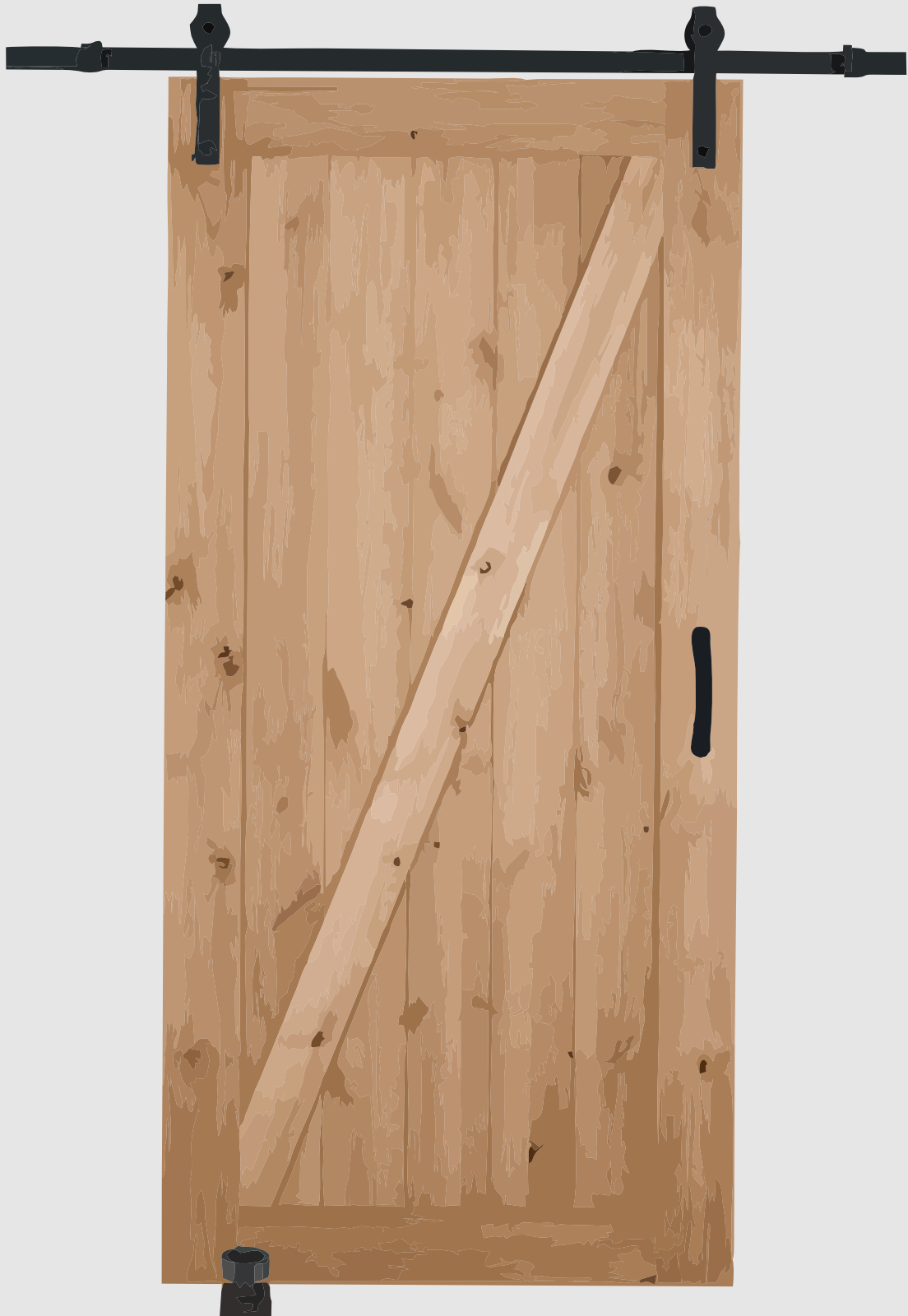

A BRAND YOU CAN TRUST

Nomenclature Chart

Step 1: Choose one of the 8 variations listed below, whichever better suits your door setup.

Step 2: Follow instructions and diagram for specified variation to ensure you assembly it correctly, then proceed to the following page for further instruction on installation.

- A-L Bracket
- B-Lock Nuts
- C-Base Nuts
- D-Wall Screws
- E-Long Bolt
- F-Medium Bolt
- G-Short Bolt x2
- H-Small Roller x2
- I-Large Roller
- J-Spacer

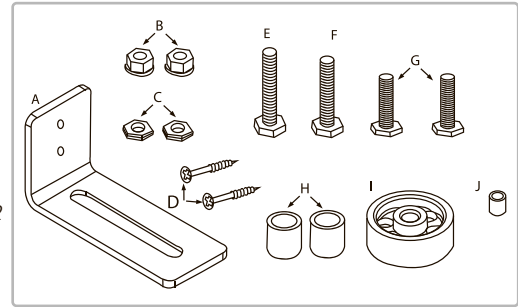

Variation 1

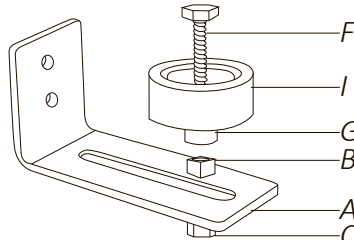
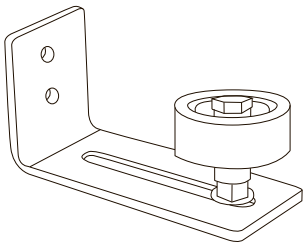

Slide larger roller (I) and spacer (J) onto medium bolt (F) with locking side.

Screw lock nut (B) onto bolt (F) with locking side facing away from spacer (J).

Place base nut (C) in groove on bottom of bracket (A). Hold base nut in place and screw assembled bolt into base nut but do not fully tighten down till after properly situated with door. Refer to following page for installation.

Variation 2

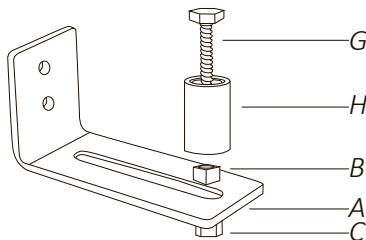
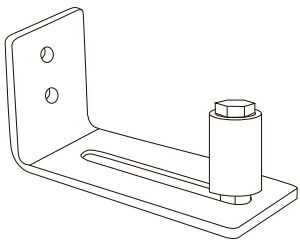

Slide small roller (H) onto small bolt (G).

Screw lock nut (B) onto bolt (G) with locking side facing away from roller (H).

Place base nut (C) in groove on bottom of bracket (A). Hold base nut in place and screw assembled bolt onto base nut but do not fully tighten down till after properly situated with door. Refer to following page for installation.

Variation 3

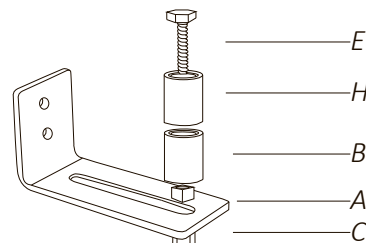
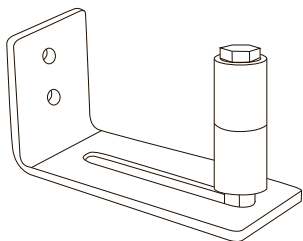

Slide small rollers (H) onto long bolt (E).

Screw lock nut (B) onto bolt (E) with locking side facing away from rollers (H).

Place base nut (C) in groove bottom of bracket (A). Hold base nut in place and screw assembled bolt onto base nut but do not fully tighten down till after properly situated with door. Refer to following page for installation.

Variation 4

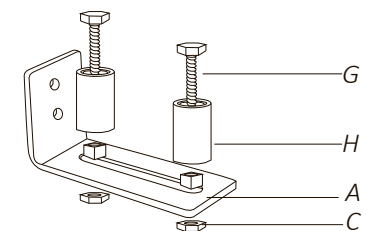
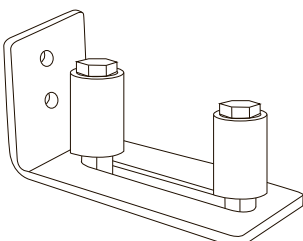

Slide small rollers (H) onto small bolts (G).

Screw lock nuts (B) onto bolts (G) with locking side facing away from rollers (H).

Place base nuts (C) in groove on bottom of bracket (A). Hold base nuts in place and screw assembled bolts into base nuts but do not fully tighten down till after properly situated with door. Refer to following page for installation.

Variation 5

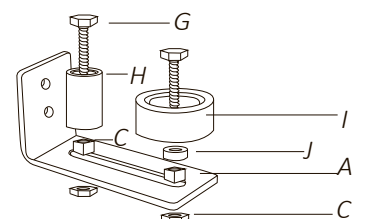
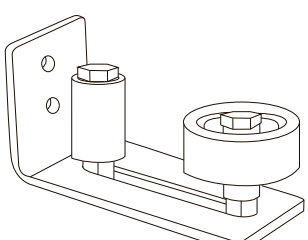

Slide small roller (H) onto small bolt (G). Slide large roller (I) and spacer (J) onto medium bolt (F).

Screw lock nuts (B) onto bolts (G) and (F) with locking side facing away from rollers (H) and (I).

Place base nuts (C) in groove on bottom of bracket (A). Hold base nuts in place and screw assembled bolts into base nuts but do not fully tighten down till after properly situated with door. Refer to following page for installation.

Variation 6

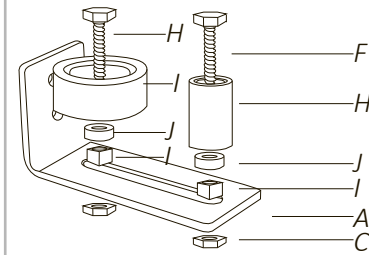
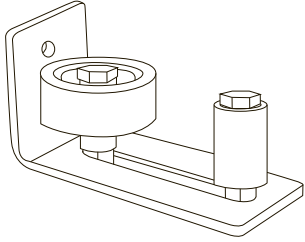

Slide small roller (H) onto small roller (I) and spacer (J) onto medium bolt (F).
Screw lock nuts (B) onto bolts (G) and (F) with locking side facing away from rollers (H) and (I).
Place base nuts (C) in groove on bottom of bracket (A).
old base nuts in place and screw assembled bolts into base but do not fully tighten down until after properly situated with door. Refer to the following page for installation

Variation 7

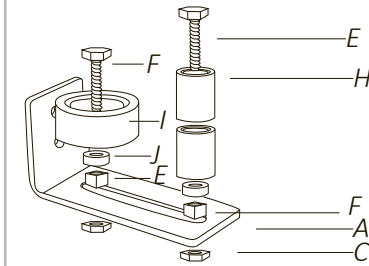
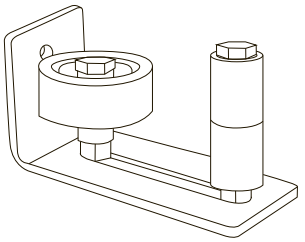

Slide small rollers (H) onto long bolt (E). Slide large roller (I) and spacer (J) onto medium bolt (F).
Screw lock nuts (B) onto bolts (E) and (F) with locking side facing away from rollers (H) and (I).
Place base nuts (C) in groove on bottom of bracket (A).
Hold base nuts in place and screw assembled bolts into base nuts but do not fully tighten down until properly situated with door. Refer to the following page for installation.

Variation 8

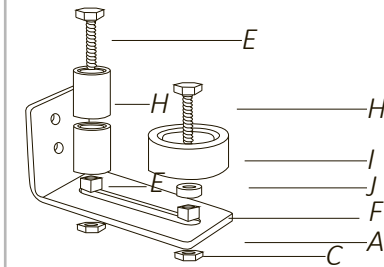
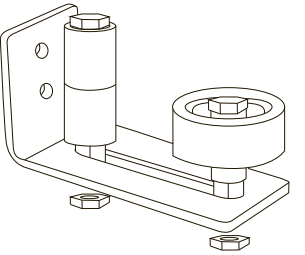

Slide small rollers (H) onto long bolt (E). Slide large roller (I) and spacer (J) onto medium bolt (F).
Screw lock nuts (B) onto bolts (E) and (F) with locking side facing away from rollers (H) and (I).
Place base nuts (C) in groove on bottom of bracket (A).
Hold base nuts in place and screw assembled bolts into base nuts but do not fully tighten down until properly situated with door. Refer to the following page for installation.

Inspection Checklist

1. Ensure L-Bracket is mounted firmly against wall.
2. Ensure that bottom of door slides just above L-Bracket
3. Ensure roller(s) are properly adjusted to bottom of door
4. Ensure door remains level and plumb after door adjustment
5. Ensure locking nut(s) is fully tightened after adjustment
6. Ensure a small gap remains between the top of each bolt and the top of each roller(s) to allow for roller(s) to spin freely.

A BRAND YOU CAN TRUST

Instructions for Installing Caldwell Company's Barn Door



1. Carefully remove door from rail track and place to the side. (Use help to move door to prevent any strain or injury).
a. Place floor protection down before removing door to prevent accidental damage to the floor.

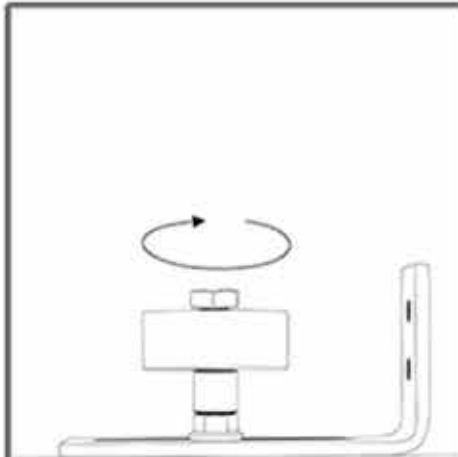

2. Set main bolt of door guide flush with bottom of guide bracket to ensure there is no interference with floor and that guide sits flush with floor.
a. Tighten bolt once bolt is set flush

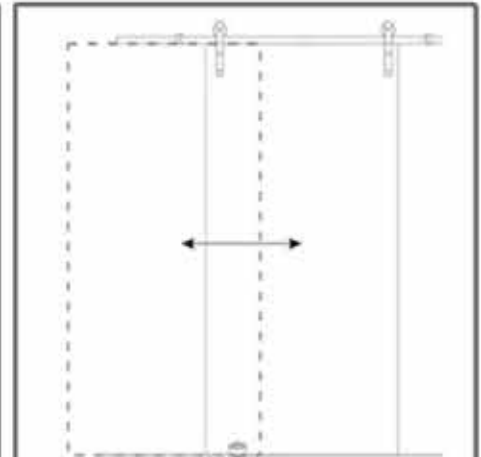

3. Place the door guide near the door opening, approximately 1-3" from interior edge of door jamb.
a. You want to make sure the door guide captures the door and holds it in place when door is both opened and in closed position.



4. Set door guide directly on floor and slide up against baseboard or face of trim, whichever is present in your circumstance.

a. Note: Door guide can be installed directly to wall, however, make sure it is screwed into a stud or that the proper wall anchors are used for your specific application.
b. The screws included are for wood application only.



5. (Optional): Pre-drill holes with a 1/16" drill bit before screwing into wood. This is especially important if screwing close to edge of trim or baseboard.

a. Stay at least 1/2" away from any edge when installing screws.

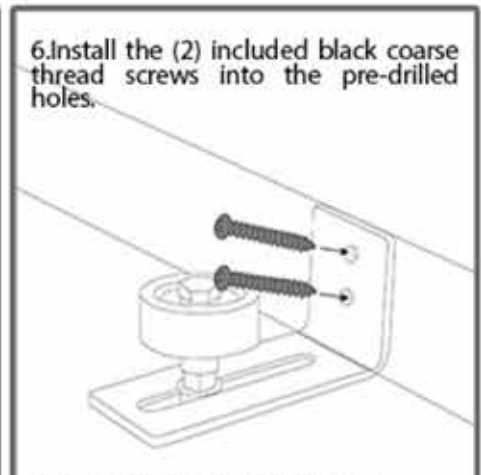

6. Install the (2) included black coarse thread screws into the pre-drilled holes.

a. Make sure not to overtighten. Just snug these up.

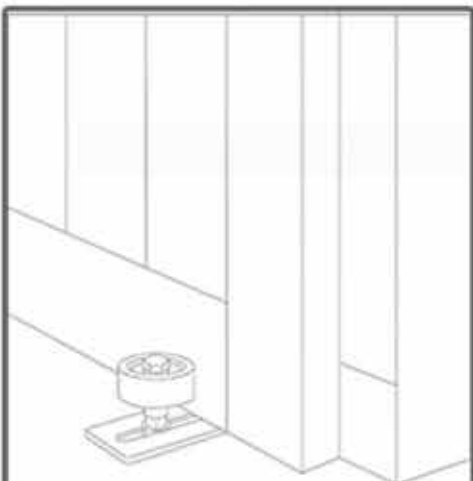

7. Carefully rehang the door back on its track.



8. Adjust guide roller until it sits nicely up against door bottom and tighten bolt.

a. Bolt can be tightened by using turning top bolt clockwise and holding bottom bolt in place.

9. Your all done!

Instructions for installing Caldwell Company's sliding door latch

1. Slide barn door into closed position and mark the desired height you would like your latch to be.

a. Latch can be installed on either the interior door jamb or edge of the door. It depends on which room you want to be able to lock.

b. For illustration methods: Installing on door jamb will be (Method 1) and installing on edge of door will be (Method 2).

2. Place base plate of door latch onto wall or edge of door, with tapered edge facing down towards the floor.

a. For (Method 1): Depending on the gap between the wall and edge of door, the placement of the latch will vary.

b. For (Method 2): Install latch centered with edge of door. If large gap, the latch can be shifted inward toward wall.

3. Install the included (flat head screw) in the center hole of base plate.

a. Note: If close to door edge or jamb, it is recommended to pre-drill these holes to prevent splintering. Use a smaller width bit than width of the screw.

4. Plumb base plate and install the two large black spacers on the top and bottom screw openings.

5. Place the other side of the latch overtop of the base plate and line up screw holes with black spacers and install screws and washers. (Make sure the lever/handle is facing toward you during installation). Install screws in the (2) remaining holes at top and bottom.

a. This step uses the (2) larger screws that are included. The (2) small screws are used later for the strike plate.

6. Once latch is in place, close door and place the strike plate over top the door and slide lock over like it would be if already installed.

Position strike in desired location on door and mark top, bottom, and center of strike.

a. Note: This is just to get an idea of where it will go and ensure it is installed in the correct location once door is closed.

7. Find markings on door and install strike onto door with the pre-drilled screw holes and screw into the door.

a. Make sure strike is plumb on door before screwing and double check markings and positioning before final installation.

b. If you wish and if needed, you can also router out the strike section at the door to provide a deeper pocket for the latch to sit. Only do this if completely necessary as it will require you cutting into the door.

8. Your all done!