

Accuphase

PRECISION MDS D SA-CD PLAYER

DP-770

- High-rigidity, high-precision aluminum machined SA-CD/CD drive with low center of gravity
- MDS D/MDS++ D/A converter driving 8 parallel channels using ANCC
- Programmable playlists so that you can enjoy your music in the order you want
- Data disc playback
- Direct Balanced Filter with completely separate line and balanced signals
- Display with sampling frequency and number of quantization bits
- Abundant transport outputs and digital inputs
- Digital connections to an Accuphase Voicing Equalizer
- Balanced output phase selector



SUPER AUDIO CD

COMPACT
disc
DIGITAL AUDIO



Our highest performing combined SA-CD/CD player

The high-rigidity, high-precision drive traverse mechanism equipped with an outer rotor brushless DC motor drive rotates discs smoothly and delivers accurate data reading, while the 8MDSD (DSD signal) / 8MDS++ (PCM signal) type D/A converter driving the ES9028 PRO (ESS Technologies) processor in 8 parallel channels converts the inputs into highly precise analog signals. The DP-770 also incorporates numerous noise suppression technologies like ANCC* to create an unparalleled musical experience.

The Technology of Precision

Transporter Features and Characteristics

Accurate Reading

Vibration countermeasures in SA-CD/CD players that read audio data from rapidly rotating discs greatly impact sound quality. The DP-770 uses a highly rigid 6.9 kg (15.2 lbs) SA-CD/CD drive mounted on a 3.4 kg (7.5 lbs) bottom plate to create a low center of gravity. This prevents the housing from wobbling, while significantly reducing external vibrations from reaching the traverse mechanism. The traverse and disc loading mechanisms are assembled using elastic dampers of two different hardnesses to reduce resonance in the objective lens and actuator, thus improving reading precision.

Smooth Disc Loading

Carved from an aluminum block and then finished with a hard anodized aluminum and satin treatment, the elegant and elaborate disc tray uses high-quality dual stay bearing shafts to open and close smoothly and quietly.

Quiet Operation

The DP-770 uses an outer rotor brushless DC motor to rotate discs. The minimal vibration and operating noise of this motor create a listening environment so quiet that it almost feels like there is no rotating component at all.

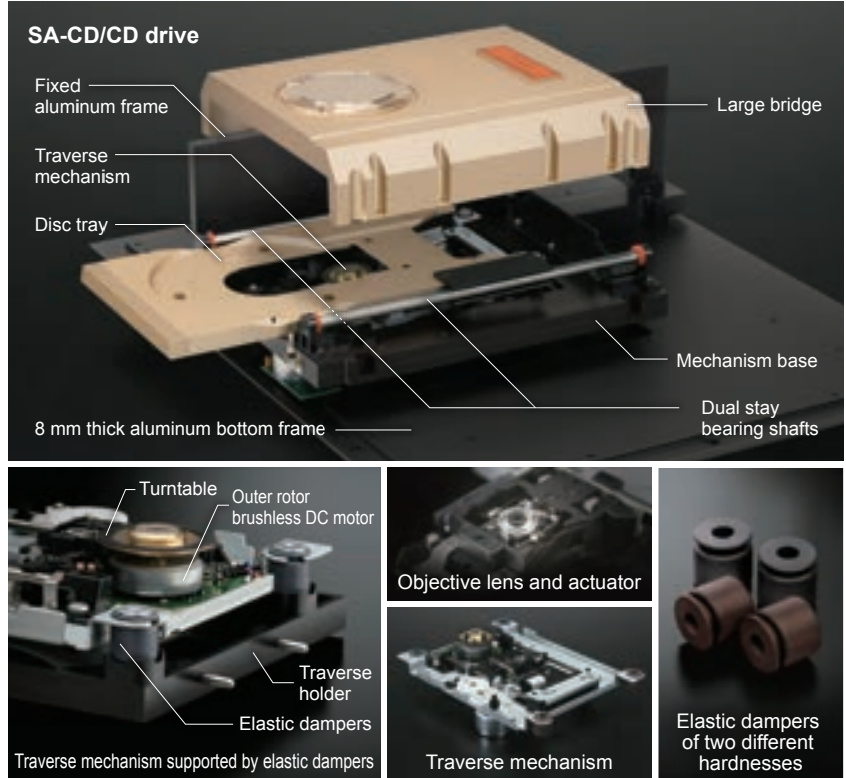

Digital Processor Features and Characteristics

MDSD (Multiple Double Speed DSD) Principle

Typical D/A converters process sound sources that use DSD signals by first converting the source to a PCM signal and then using a digital filter to remove high frequency noise. The MDSD principle employed in the DP-770, however, inputs 8 phase-shifted DSD signals into the 8 parallel channels in the MDS++ type D/A converter. The entire circuit then operates as a moving-average filter with completely linear phase characteristics to eliminate high frequency noise. MDSD represents a ground-breaking playback method that eliminates high frequency noise without converting DSD signals into PCM signals.

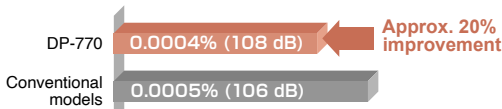

Total harmonic distortion + noise performance (guaranteed values)

MDS++ (Multiple Delta Sigma) Converter Principle with 8 Parallel Channels

The D/A converter drastically improves performance with the MDS++ conversion principle by driving multiple delta-sigma type D/A converters connected in parallel. By passing output from the high-performance ES9028PRO (ESS Technologies) through 8 parallel converter channels, the DP-770 provides a theoretical 2.8x (=√8) increase in overall performance for distortion, noise, linearity, and more. Because the improvements provided by the MDS++ principle are independent of signal frequency and level, noise at very low levels can also be minimized, a feat that conventional delta-sigma converters find extremely difficult to achieve.

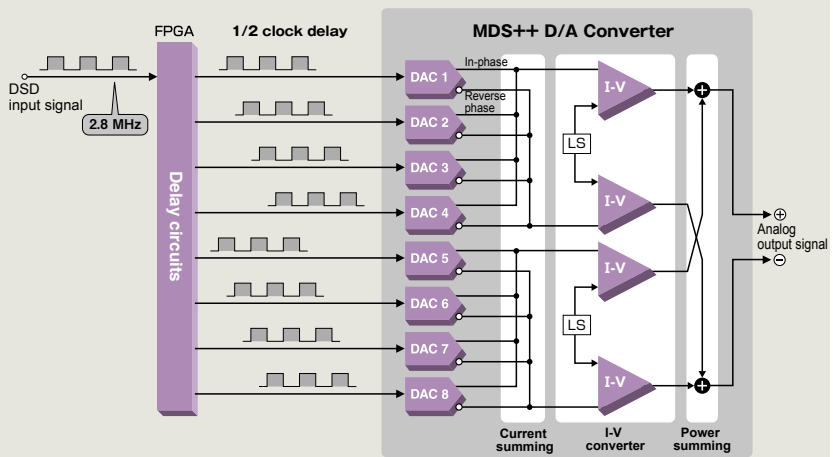
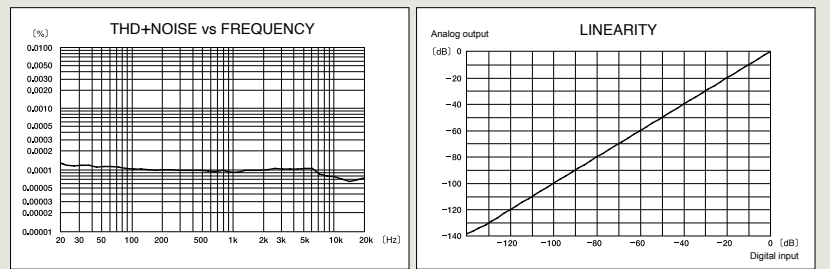

LS: Level Shifter
I-V: I-V conversion amplifier using ANCC

MDSD principle block diagram

*: ANCC is a technology that improves performance by using a sub-amplifier to cancel noise and distortion in the main amplifier.

Advanced Features

- High-rigidity, high-precision machined aluminum SA-CD/CD drive with a low center of gravity
- Data disc playback (including DSD discs)
- Digital connections to an Accuphase Voicing Equalizer
- Abundant digital inputs (HS-LINK, COAXIAL, OPTICAL, USB) ... ①
- Plentiful transport outputs (HS-LINK, COAXIAL, OPTICAL) ... ②
- 2 (BALANCED, LINE) analog outputs ... ③
- Phase selector to invert the balanced output ... ④
- Display with sampling frequency and number of quantization bits ... ⑤
- MDS / MDS++ D/A converter driving 8 parallel channels using ANCC ... ⑥
- Direct Balanced Filter circuit with completely separate line and balance signals on a glass cloth fluorocarbon resin substrate with low dielectric constant and minimum loss ... ⑦
- Low noise power circuits equipped with custom-made smoothing capacitors for high sound quality ... ⑧
- Large power supply transformer with independent analog and digital channels ... ⑨
- Natural grain wood case with a mirror finish handcrafted by artisans using carefully selected virgin wood ... ⑩
- 8 mm thick machined aluminum bottom plate ... ⑪
- Advanced high-carbon cast iron insulators ... ⑫
- High quality audio cable ASL-10B ... ⑬
- Programmable playlists so that you can enjoy track playback in any order ... ⑭
- Output level adjustment ... ⑮



① Digital inputs

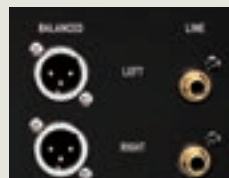

③ Analog outputs



⑤ Sampling frequency and quantization bit display (2.8 MHz/1-bit)

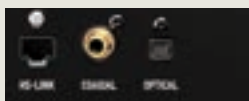

② Transport outputs



④ Phase selector switch



Current track display (track 4 of 8)

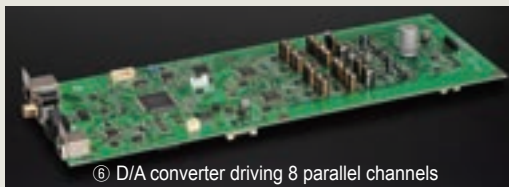

⑥ D/A converter driving 8 parallel channels



⑦ Direct balanced filter

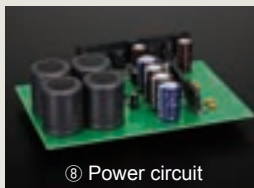

⑧ Power circuit



⑨ Power transformers

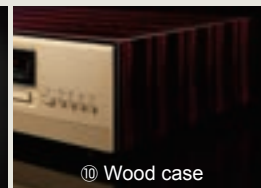

⑩ Wood case

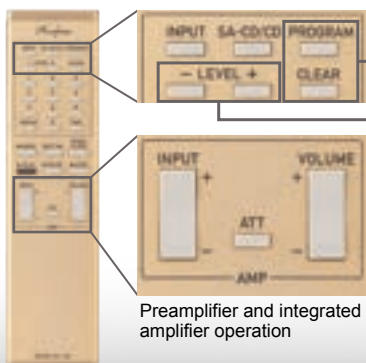

⑭ Programmable playlists

⑮ Output level adjustment



Preamplifier and integrated amplifier operation



⑪ Bottom plate

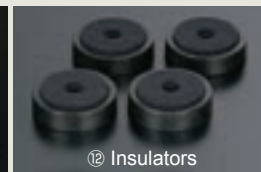

⑫ Insulators

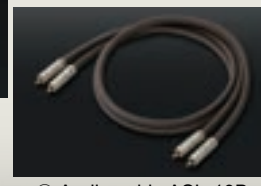

⑬ Audio cable ASL-10B

■ Remote Commander RC-140 (included)



Connecting to a Voicing Equalizer

Connecting a voicing equalizer between the DP-770's transport outputs and digital inputs allows for acoustic corrections to the digital signals of the CD playback in the digital domain.

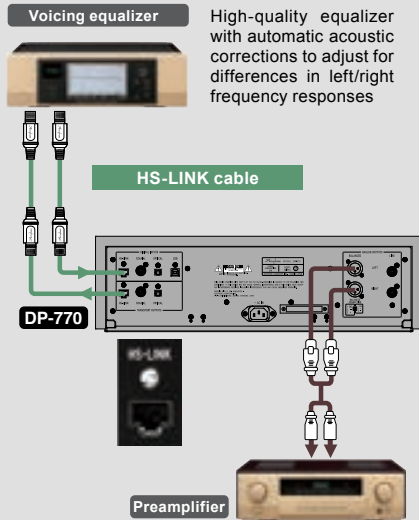

Connecting to TVs, etc.

When connecting to a TV or other device that outputs digital signals, the DP-770's high-quality D/A converter converts music and speech to analog signals so that you can enjoy them on your stereo system.

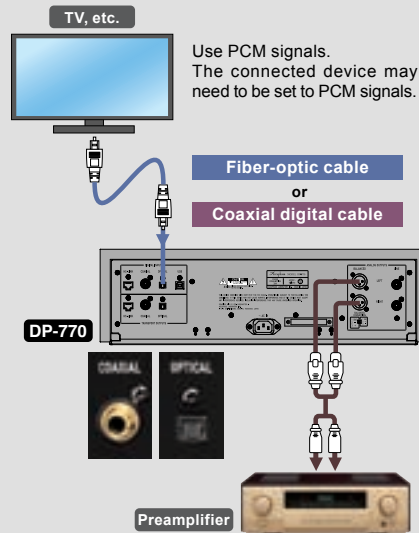

Connecting to PCs, etc.

The DP-770 features a USB port (type B) for high resolution data playback when connecting to a PC using a USB cable.

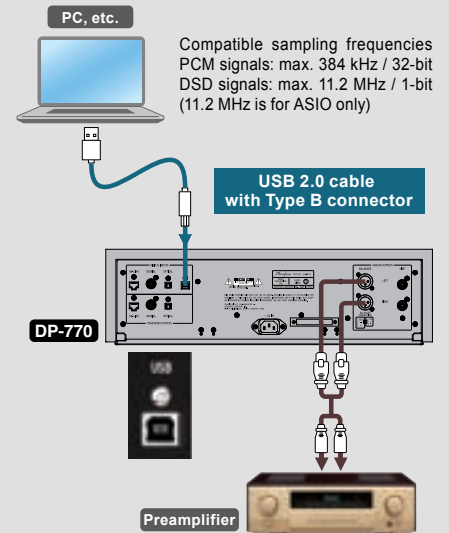

Front Panel

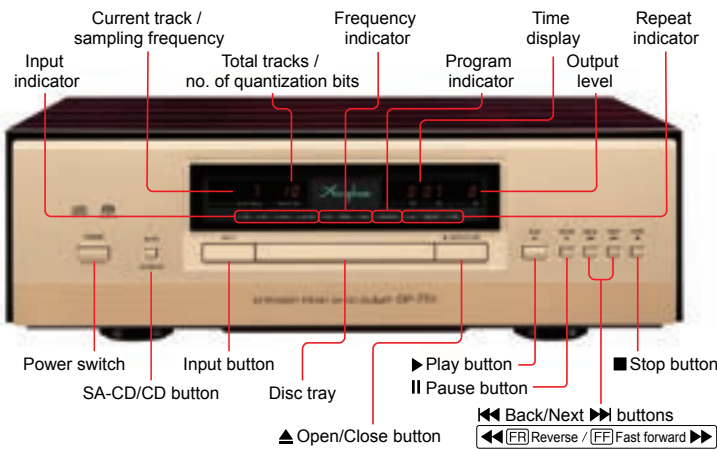

Rear Panel

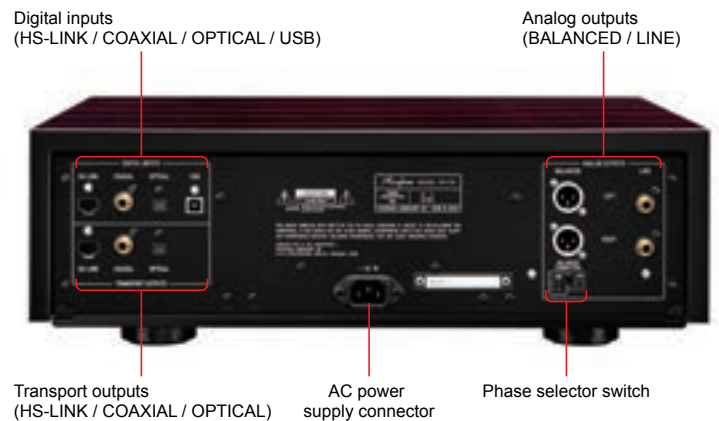

DP-770 Guaranteed Specifications

Compatible Disc Formats	2-channel Super Audio CD		
	CD		
Data Read Principle	Data disc	CD-R/-RW DVD-R/-RW/+R/+RW	Supported formats: WAV, FLAC, DSF, DSDIFF
	Non-contact optical pickup		
Laser Diode Wavelength	SA-CD	655 nm	
	CD	790 nm	
Transport Outputs	HS-LINK	Proprietary standard	Dedicated HS-LINK cable
	OPTICAL	JEITA CP-1212 compliant	JEITA standard optical fiber cable
	COAXIAL	IEC 60958 / AES-3 compliant	75-ohm coaxial digital cable
Digital Inputs	HS-LINK	Proprietary standard	Dedicated HS-LINK cable
	USB	USB 2.0 High-Speed (480 Mbps) standard	USB 2.0 cable with Type B connector
	OPTICAL	JEITA CP-1212 compliant	JEITA standard optical fiber cable
	COAXIAL	IEC 60958 / AES-3 compliant	75-ohm coaxial digital cable

Sampling Frequencies	HS-Link (Ver. 1)	DSD	2.8 MHz	1-bit
	HS-Link (Ver. 2)	PCM	32 / 44.1 / 48 / 88.2 / 96 / 176.4 / 192 kHz	16 to 24-bit
		DSD	2.8 / 5.6 MHz	1-bit
	USB	PCM	32 / 44.1 / 48 / 88.2 / 96 / 176.4 / 192 / 352.8 / 384 kHz	16 to 32-bit
		DSD	2.8 / 5.6 / 11.2 MHz (11.2 MHz: ASIO only)	1-bit
		PCM	44.1 / 48 / 88.2 / 96 / 176.4 / 192 / 352.8 / 384 kHz	16 to 32-bit
OPTICAL	PCM	32 / 44.1 / 48 / 88.2 / 96 kHz	16 to 24-bit	
	COAXIAL	PCM	32 / 44.1 / 48 / 88.2 / 96 / 176.4 / 192 kHz	16 to 24-bit
D/A Converter	DSD	8 MDS principle		
	PCM	8 MDS++ principle		
Frequency Response	0.5 to 50,000 Hz		+0, -3.0 dB	
Total Harmonic Distortion + Noise	0.0004%		20 to 20,000 Hz	
Signal-to-Noise Ratio	121 dB			
Dynamic Range	119 dB			
Channel Separation	118 dB		20 to 20,000 Hz	
Output Voltage and Impedance	BALANCED	2.5 V 50 ohms		Balanced XLR type
	LINE	2.5 V 50 ohms		RCA phono jack
Output Level Control	0 dB to -80 dB		1-dB steps	Digital
	Power Requirements			
Power Consumption	120 V, 220 V, 230 V AC (voltage as indicated on rear panel), 50/60 Hz			
Maximum Dimensions	30 W			
	Width 477 mm (18.8 in) × Height 156 mm (6.1 in) × Depth 395 mm (15.6 in)			
Mass	Net		28.5 kg (62.8 lbs)	
	In shipping carton		36 kg (80 lbs)	

Supplied accessories

- AC power cord (2 m)
- USB Utility 3 CD
- Audio cable ASL-10B with plugs
- USB Utility 3 CD Setup Guide
- Remote Commander RC-140
- Cleaning cloth

Remarks

- ★ This product is available in versions for 120/220/230 V AC. Make sure that the voltage shown on the rear panel matches the AC line voltage in your area.
- ★ The 230 V version has an Eco Mode that switches power off after 120 minutes of inactivity.
- ★ The shape of the plug of the supplied AC power cord depends on the voltage rating and destination country.



ACCUPHASE LABORATORY, INC.