

RELAXONCHAIR®

RC-MK II

USER MANUAL

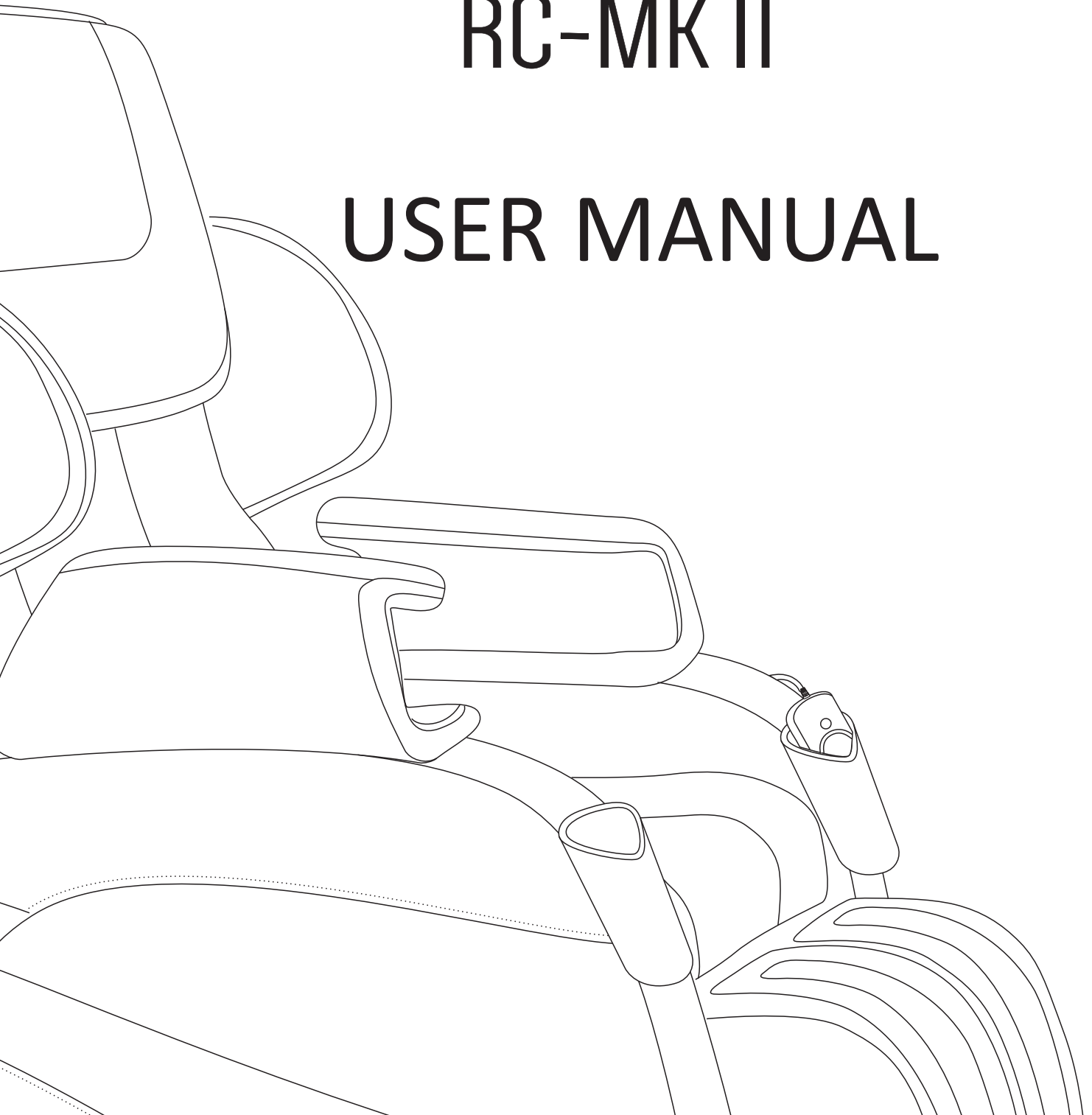

RELAXONCHAIR

RC-MKII Massage Chair

Congratulations and thank you for trusting RELAXONCHAIR. You are about to discover the many joys of owning a premium RELAXONCHAIR™ RC-MKII Massage Chair. Massage, combined with healthy eating, exercise and a good sleep regimen, is a great way to take care of your body & mind, leading to a happy, productive lifestyle.

For many years, RELAXONCHAIR has been the trusted source for quality massage products that improve your life. The RELAXONCHAIR™ RC-MKII Massage Chair represents our heritage of delivering amazing, quality products since the beginning. It is covered by our exclusive 3 year limited warranty. Take comfort in knowing our quality engineering team goes the extra mile every day, to make sure our customers rarely need it.

We believe you are going to love this chair. If so, please tell others how it has changed your life. If we have somehow let you down, please tell us directly. Continuous feedback from our customers, either loving the products or helping us to improve them, is critical to RELAXONCHAIR's success.

To communicate directly with us, please contact the RELAXONCHAIR Customer Care Center at (866) 647-3496. Representatives are available to assist you Monday through Friday from 9:00 A.M. to 5:00 P.M. (Pacific Time). You could also email us anytime at help@relaxonchair.com

Sincerely yours,

RELAXONCHAIR Product Development Team

Table Of Contents

Safety, Cautions and warnings	4
Names of parts and functions	10
Preparation before use	12
Massage programs and selections	16
Product care and storage, specifications	19
Warranty	20

Before you start using your RELAXONCHAIR™ RC-MKII M assage Chair, please read this operation manual thoroughly for correct methods of usage, especially the section on safety.

This manual should be kept on hand for easy reference. It is your guide to safe and efficient operation.

Safety, Cautions and Warnings

IMPORTANT SAFETY INSTRUCTIONS

When using the RELAXONCHAIR™ RC-MKII Massage Chair, basic precautions should always be followed, including the following: Read all instructions before using the RELAXONCHAIR™ RC-MKII Massage Chair.

DANGER – To reduce the risk of electric shock:

1. Always unplug this RELAXONCHAIR™ RC-MKII Massage Chair from the electrical outlet immediately after using and before cleaning.
2. Never use pins or other metallic fasteners with this appliance.
3. Carefully examine the covering before each use. Call for service if the covering shows any sign of deterioration, such as blistering, peeling or cracking.
4. Keep dry – Do not operate in wet or moist conditions.

WARNING – To reduce the risk of burns, fire, electric shock or injury to persons:

READ ALL INSTRUCTIONS BEFORE USING.

1. RELAXONCHAIR™ RC-MKII Massage Chair should never be left unattended when plugged in. Unplug from the outlet when it is not in use and before putting on or taking of parts.
2. Close supervision is necessary when this RELAXONCHAIR™ RC-MKII Massage Chair is used by or near children or disabled persons. Keep children away from reclining backrest and extended leg rest.
3. Use this RELAXONCHAIR™ RC-MKII Massage Chair only for its intended use as described in this manual. Do not use attachments not recommended by the manufacturer.
4. Never operate this RELAXONCHAIR™ RC-MKII Massage Chair if it has a damaged cord or plug, if it is not working properly, if it has been dropped or damaged, or dropped into water. Contact RELAXONCHAIR™ Customer Service at (866) 647-3496.
5. Do not carry this RELAXONCHAIR™ RC-MKII Massage Chair by the power cord or use cord as a handle.
6. Keep the cord away from heated surfaces.
7. Never operate the RELAXONCHAIR™ RC-MKII Massage Chair with the air openings blocked. Keep the air openings free of lint, hair and the like.
8. Never drop or insert any object into any opening.
9. Do not use outdoors. RELAXONCHAIR™ RC-MKII Massage Chair is intended for indoor only.
10. Do not operate where aerosol (spray) products are being used or where oxygen is being administered.

Safety, Cautions and warnings

11. To disconnect, turn all control to the off position, then remove the plug from the outlet.
12. Do not stand on or in the RELAXONCHAIR™ RC-MKII Massage Chair. Use only while seated properly.
13. The product is not intended for use by children or persons with reduced physical, sensor or mental capabilities, or lack of experience and knowledge unless they have been given supervision or instruction concerning use of the product by a person responsible for their safety.
14. Children should be supervised and ensure that they do not play with the product.
15. Use heat feature carefully. May cause serious burns. Do not over use if you have sensitive skin or if you have poor circulation. The unattended use of heat by children or disabled persons may be dangerous. Check the skin in contact with the heated area of the appliance frequently to reduce the risk of blistering.
16. Burns may result from improper use.
17. Do not crush – avoid sharp folds.
18. Keep children away from extended foot support (or other similar parts).
19. DO NOT WET – DO NOT USE PINS.
20. NEVER REMOVE COVER.
21. Connect this appliance to a properly grounded outlet only. See Grounding instructions.

SAVE THESE INSTRUCTIONS

This RELAXONCHAIR™ RC-MKII Massage Chair is intended for household use only.

1. Usage Environment

- Do not use the RELAXONCHAIR™ RC-MKII Massage Chair in an excessively humid or dusty environment as this may result in malfunction or electric shock.
- Do not use the RELAXONCHAIR™ RC-MKII Massage Chair in a room with a temperature of 104° F or higher.
- Do not expose the RELAXONCHAIR™ RC-MKII Massage Chair to heater, stoves or direct sunlight.
- Place and use the RELAXONCHAIR™ RC-MKII Massage Chair on an even, non-slip floor.
- The RELAXONCHAIR™ RC-MKII Massage Chair is designed for home use and not for commercial purposes.

Safety, Cautions and warnings

Caution

- ⚠ The RELAXONCHAIR™ RC-MKII Massage Chair is to be used indoors only.
- ⚠ If you use the RELAXONCHAIR™ RC-MKII Massage Chair in a cold room, do not increase the room temperature abruptly. It is recommended that you increase the temperature gradually to a normal level.
- ⚠ If the RELAXONCHAIR™ RC-MKII Massage Chair is stored in a cold place and is being brought into a warm environment, it is advisable to wait one hour before use. This is because its performance may not be at optimum level as there may be water droplets on the mechanical parts due to condensation. Using the RELAXONCHAIR™ RC-MKII Massage Chair under such conditions may result in malfunction.

2. Safety Precautions

- To ensure safe and correct use of the RELAXONCHAIR™ RC-MKII Massage Chair, do not operate it without reading this operation manual carefully.
- Do not use the RELAXONCHAIR™ RC-MKII Massage Chair when the upholstery or seat is removed. This may cause injury or malfunction.
- Do not use the RELAXONCHAIR™ RC-MKII Massage Chair in combination with other therapeutic equipment or electric blanket etc. as this may result in ineffectiveness or injury.
- Do not use the RELAXONCHAIR™ RC-MKII Massage Chair an hour before or after eating as this may have adverse effects on the user.
- Do not allow children or pets to play around the RELAXONCHAIR™ RC-MKII Massage Chair, e.g., behind the backrest, under the seat or leg rest of the RELAXONCHAIR™ RC-MKII Massage Chair. This may result in injury.
- Do not rest or place heavy objects on the armrests, leg rest or backrest as this may result in malfunction or injury.
- Do not use the RELAXONCHAIR™ RC-MKII Massage Chair when your body is wet.
- Do not operate the RELAXONCHAIR™ RC-MKII Massage Chair with wet hands.
- It is not recommended to use the massage for more than 20 minutes.
- Do not perform continuous massage on the same spot of your body for more than 5 minutes at a time as this may result in excessive stimulation and may have adverse effects.
- Do not insert your hand or foot along the paths of the massage rollers during use as this may cause injury.
- Stop operation immediately if you experience any discomfort.
- This product is not intended for self-treatment of conditions that should be managed by a qualified health care provider.
- People on medication or with medical conditions, please consult your doctor before use. Please do not use the product if you are not feeling well.

Safety, Cautions and warnings

- Remove all scarves, neckties, necklaces and jewelry before using the massager.

3. People with Medical conditions

Consult your doctor before use if you:

- Are under medical rest as ordered by a doctor.
- Have spinal disorders, an abnormal spinal condition or have suffered a spinal injury.
- Have back problems.
- Have diabetes, osteoporosis or sensory impairment.
- Have joint dysfunction.
- Have a pacemaker or other electronic medical devices.
- May be pregnant.
- Have phlebitis or thrombosis.
- Have an increased risk for blood clots.
- Had recent surgery.
- Have surgical pins, screws, or anything mechanical implanted in your body.

Caution

- ⚠ The RELAXONCHAIR™ RC-MKII Massage Chair is not intended for use by children or persons with reduced physical, sensory or mental capabilities, or lack of experience and knowledge, unless they have been given supervision or instruction concerning use of the RELAXONCHAIR™ RC-MKII Massage Chair by a person responsible for their safety.
- ⚠ Children should be supervised to ensure that they do not play with the RELAXONCHAIR™ RC-MKII Massage Chair.
- ⚠ Avoid using the RELAXONCHAIR™ RC-MKII Massage Chair under the influence of alcohol.
- ⚠ Do not apply massage rollers directly on the head, elbow or knee joints, torso or abdomen.
- ⚠ If you legs or feet slip off the leg rest during massage, do not force them back in as this may result in injury.
- ⚠ Remove the power plug from the electrical outlet immediately should liquid be accidentally spilled onto the RELAXONCHAIR™ RC-MKII Massage Chair. Do not use wet hands to connect or disconnect the power plug from the electrical outlet.
- ⚠ Do not tamper with the power cord or use the RELAXONCHAIR™ RC-MKII Massage Chair with a damaged cord as this may result in malfunction and/or electric shock.

Safety, Cautions and warnings

4. Instances when the RELAXONCHAIR™ RC-MKII Massage Chair should not be used

In the following events, please switch off the main power switch immediately and disconnect the power cord from the electrical outlet:

- If water is accidentally spilled onto the RELAXONCHAIR Chair. This may result in electric shock or malfunction.
- If the fabric of the backrest is torn and the internal components are exposed.
- If pain or discomfort is felt during massage, stop operation immediately and consult your doctor.
- If you detect any malfunction or any other abnormal condition during operation.
- If there is a power outage. Injury may occur when power is restored unexpectedly.
- If there is lightning.

5. Assembly and repair of the RELAXONCHAIR™ RC-MKII Massage Chair

- Do not attempt to disassemble the RELAXONCHAIR™ RC yourself unless instructed to do so by RELAXONCHAIR's Technical Support Team. Touching the internal components may result in malfunction or electric shock.
- RELAXONCHAIR™ RC-MKII Massage Chair must be serviced or repaired by authorized service center.

6. Things to note about the power plug and cord

- Check that the Alternating Current (AC) voltage corresponds with the specification indicated for the RELAXONCHAIR™ RC-MKII Massage Chair.
- Do not connect or disconnect the power plug from the electrical outlet with wet hands. This may result in malfunction or electric shock.
- When disconnecting the power plug, pull it by holding the plug, not the cord.
- Although operation will be stopped automatically by the Auto always remember to switch off the main power switch after use.
- Do not place the power cord under the RELAXONCHAIR Chair or any other heavy objects.
- Do not wind the power cord around the RELAXONCHAIR Chair as this may damage the cord and result in a fire or electric shock.
- Do not operate the RELAXONCHAIR™ RC-MKII Massage Chair with a damaged cord or extension cord.
- Do not use the RELAXONCHAIR™ RC-MKII Massage Chair if the electrical outlet is loose.
- If the power cord is damaged, it should be replaced by a qualified technician.

Safety, Cautions and warnings

7. Grounding instruction

This product must be grounded. If it should malfunction or break down, grounding provides a path of least resistance for the electric current to reduce the risk of electric shock. This product is equipped with a cord or an equipment-grounding conductor and a grounding plug. The plug must be plugged into an appropriate outlet that is properly installed and grounded in accordance with all local codes and ordinances.

Danger – Improper connection of the equipment-grounding conductor can result in a risk of electric shock. Check with a qualified electrician or service technician if you are in doubt as to whether the product is properly grounded. Do not modify the plug provided with the product – if the supplied plug does not fit the outlet, have a proper outlet installed by a qualified technician.

This product is for use on a nominal 120V circuit and has a grounding plug that looks like the plug illustrated below. Make sure the product is connected to an outlet having the same configuration as the plug. No adapter should be used with this product.

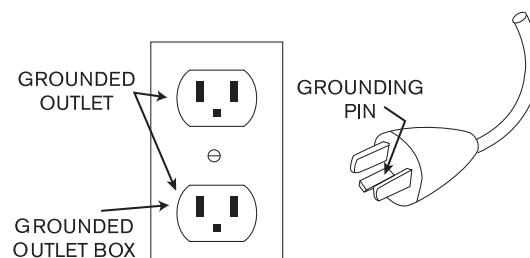

Name of parts and functions

Overview

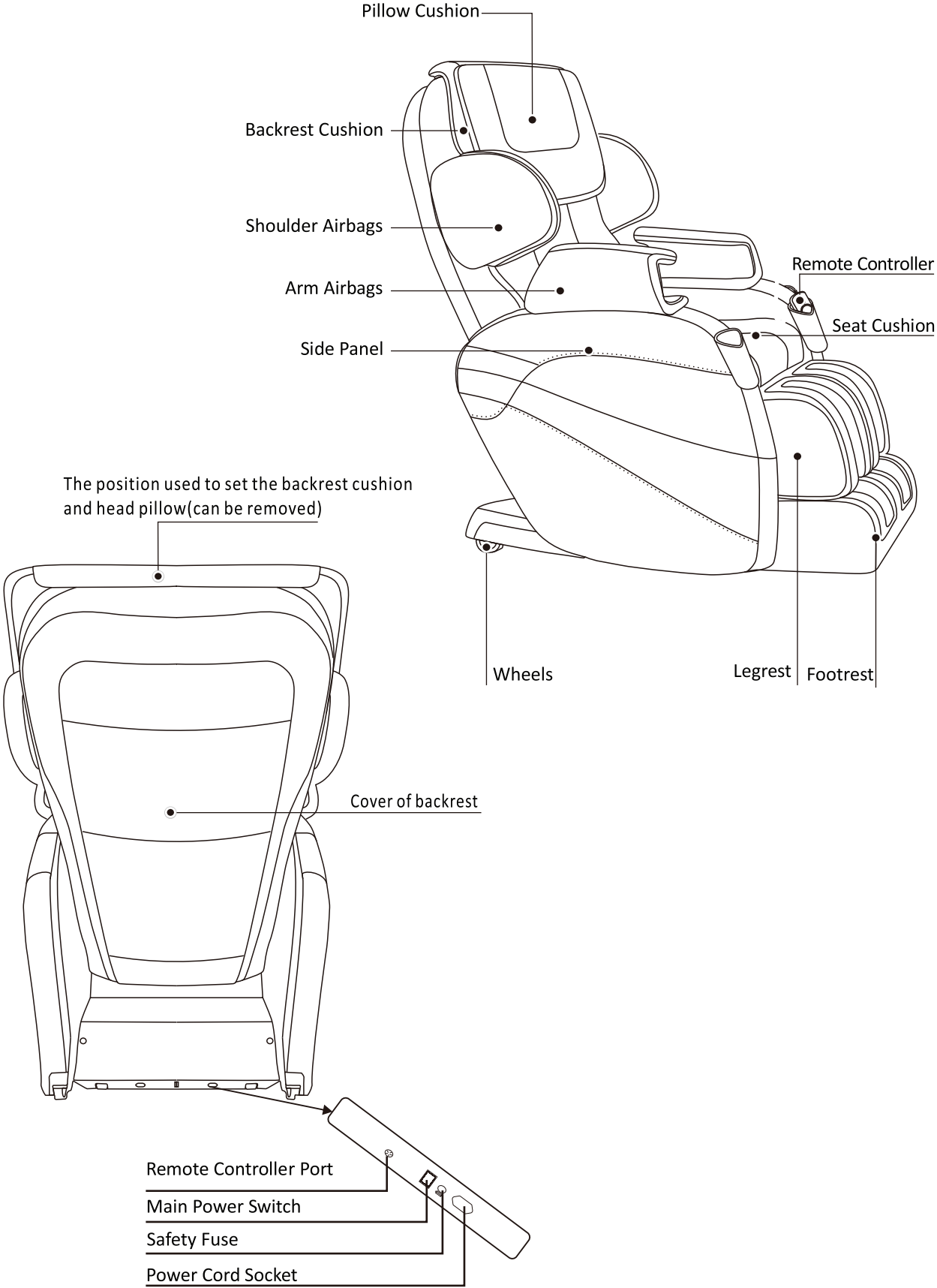

Name of parts and functions

Remote Controller

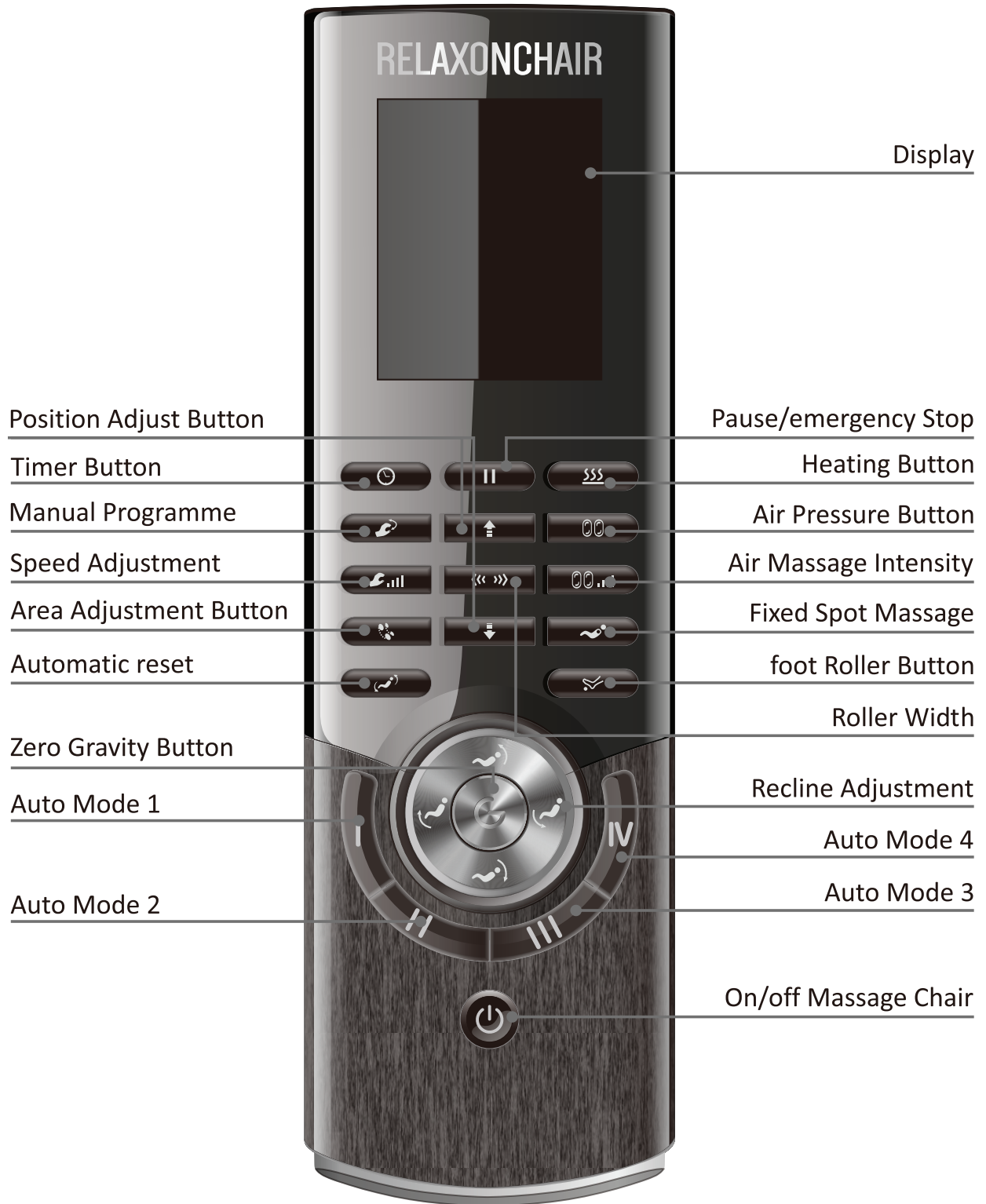

Preparation before use

1. Moving the RELAXONCHAIR™ RC-MKII Massage Chair

- Hold the back of the RELAXONCHAIR™ RC-MKII Massage Chair and push downward to recline the chair to approximately a 45° Angle.
- Roll it to desired position, using the rollers located at the rear bottom of the chair.
- Gently place the chair on the floor.

(Illustration)

Caution

⚠ Disconnect all wires and cords including power cords & remote controller before you move the RELAXONCHAIR™ RC-MKII Massage Chair.

⚠ Do not move the RELAXONCHAIR™ RC-MKII Massage Chair when there is someone sitting on it. This will cause the RELAXONCHAIR™ RC-MKII Massage Chair to tip over resulting in accident and injuries.

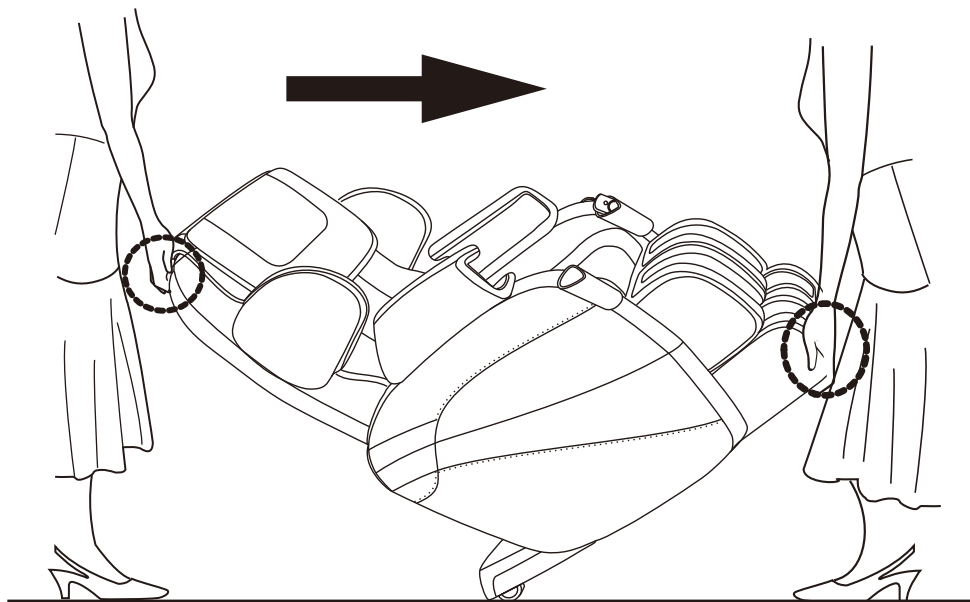

Preparation before use

2. Installation of foot rest

- RELAXONCHAIR™ RC-MKII Massage Chair is shipped with Foot Massager Attached. However, you will need to connect 2 metal Poles underneath Foot Massager. This connection of 2 metal poles will enable foot massager to move upwards or downwards for zero gravity positions.

1.Remove the package and get out the spare parts

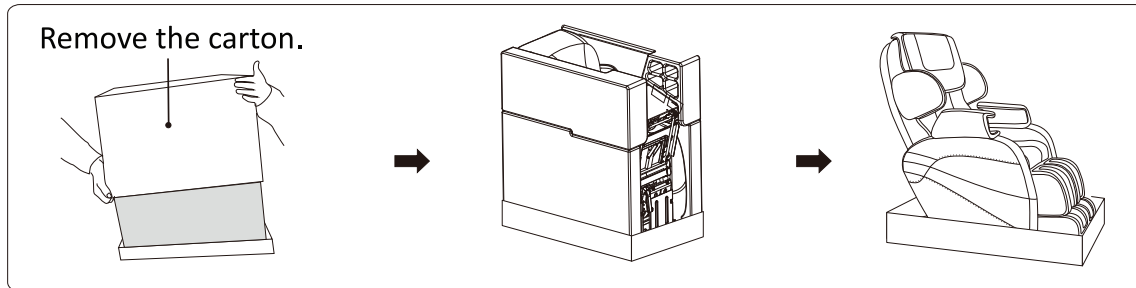

- 1) Remove the carton.
- 2) Take out the foam.
- 3) Install the Pillow, backrest cushion, cushion, spare parts.
- 4) The spare parts include: remote control, holder, user manual, wheel, power cord.

2.Install foot part

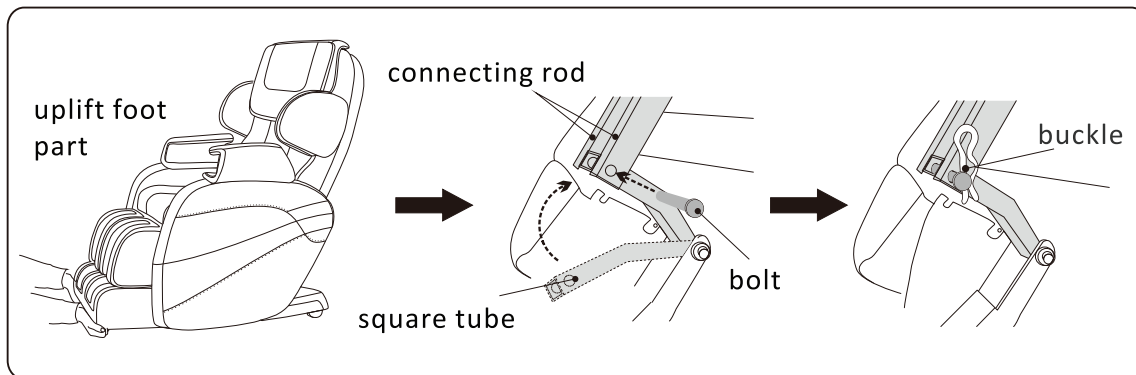

- 1) Uplift foot part to the highest place,the connecting rod hole which on the inside of foot part align with square tube hole which on massage chair,then insert bolt,fixed by the buckle.
- 2) Put down the foot part,Straighten it.

Double check installation steps, smooth out any creases in the cushions

Place the massage chair in an open area

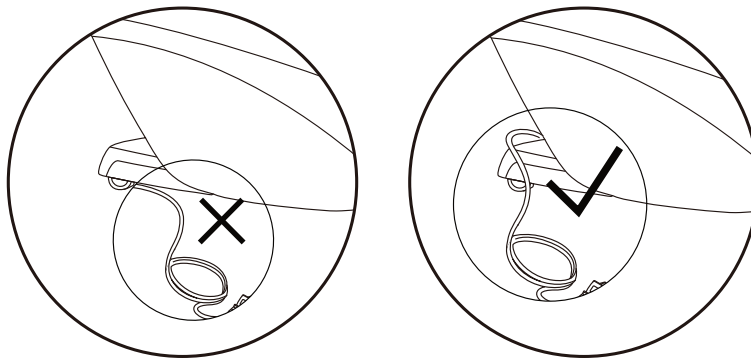
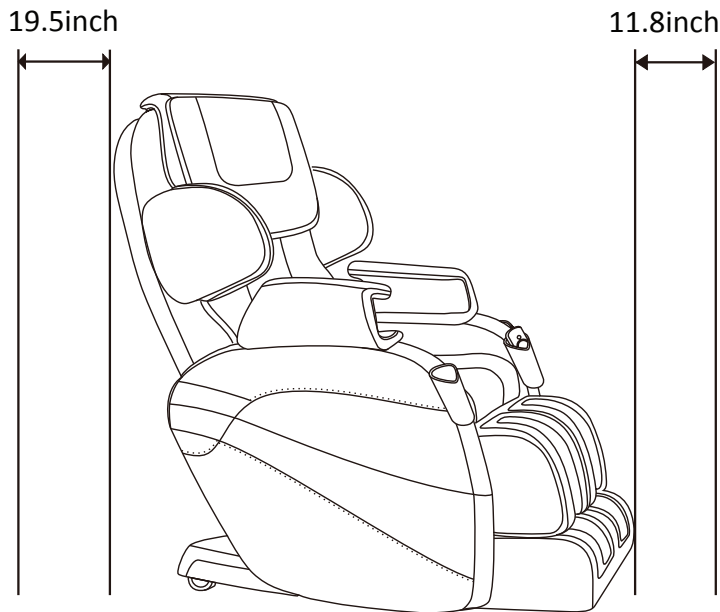

Allow sufficient space around the chair for recline purposes.
19.5inch distance for the back side and 11.8inch in front of the footrest.

- * To avoid the damage of the floor and to reduce the noise, please put area rug under the massage chair.**
- * Make sure that there are no barriers at the front and the back of the massage chair.**
- * Please do not put it in wet or uneven floor.**
- * To avoid signal interference, please place it 4 feet away from AV,TV, and radio.**

Preparation before use

3. Power On/Off

- Connect the main power cord located in the back of the chair to standard 110V electrical outlet.
- Turn On/Off the main power switch located at the back of the RELAXONCHAIR™ RC-MKII Massage Chair to power the chair On/Off.
(Illustration)

Caution



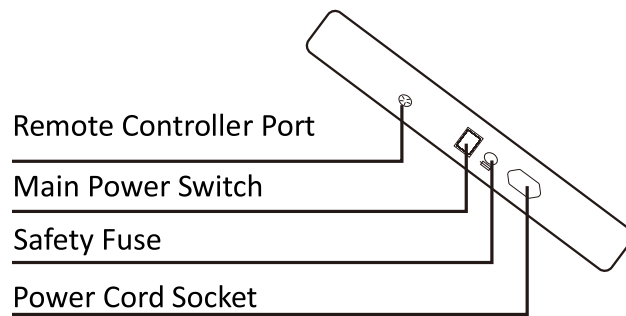

- ⚠ Ensure the power cord is not placed under the RELAXONCHAIR™ RC-MKII Massage Chair.
- ⚠ Ensure all switches are turned “OFF” including the main power switch before connecting the power cord to an electrical outlet.







Massage programs and selections

OPERATION GUIDE



DESCRIPTION OF BUTTON FUNCTIONS (INSERT IMAGE OF BUTTONS)

-  1. Power On/Off – Press power button to switch on the controller. RELAXONCHAIR MK-II massage chair will recline slightly, leg rest will be raised, and the LCD on the controller will light up. Press power button again to turn massage chair off. (Chair will come back to its original position. NOTE: Power button will continue to flash even though power is off.)
-  2. Timer Button – The massage chair is preprogrammed at an optimal 15-minute duration. Press once to increase massage duration by 5 minutes or press repeatedly to desired duration up to 30 minutes max.
-  3. Pause Button – Press this button to pause massage program. Press button again to continue with current massage.
-  4. Heating Button– Press this button to turn lower back heat on and off. When on, it normally takes about 3 minutes for the seat to get warm.
-  5. Manual Massage Button– 5 manual specific targeted massages – the manual button allows you to choose the most desirable personal massage program such as kneading, tapping, dual, shiatsu, and rolling. Press button repeatedly to browse between different massage modes.

Kneading → Tapping → Dual Mode (Kneading + Tapping) → Shiatsu → Rolling

-  6. Speed Button – 3 levels of speed is adjustable by pressing speed button (Speed for kneading, tapping, dual action & shiatsu can only be adjusted)
-  7. Sole Roller Button – Enables roller massage for soles
-  8. Spot Area Button – Press to stop the rollers at a particular area for a fixed-point focal massage in manual mode.
-  9. Back Massage Area Button – In manual mode, press button to concentrate rollers on specific areas of the body in the following order:

Upper Back Only → Lower Back Only → Buttocks Only → Upper & Lower Back Only → Lower Back & Buttocks Only → Whole Body (Upper Back to Buttocks)

-  10. UP / DOWN Button - Hold the up or down arrow to move the massage rollers in desired direction.
-  11. Width Button - Press the button to adjust width of both rollers. There are 3 adjustable levels.
-  12. Air Massage Position – By pressing this button, a spot will flash on remote display indicating the area of the body that will be air massaged. Switch between different areas of the body by pressing button more than once.

Massage programs and selections

Leg/Foot Only → Arm Only → Shoulder/Hips Only → Arm & Leg/Foot Only → All (Leg/Foot, Arm & Shoulder/Hip) → Turn Off all Air Massage System



13. Air Pressure Intensity Button – There are 3 levels of air pressure intensity for built in air bags. Press this button to switch between 3 levels of intensity. (There is no separate intensity control level for arm and another for leg/foot.)



14. Position Reset Button – Button will automatically reset chair to original position only after auto or manual mode has finished. (NOTE: Press button while in auto or manual mode to enable function. Chair will reset only after current massage mode has completed.)

Auto Mode – RELAXONCHAIR™ MKII Massage Chair provides 4 intelligent automatic programs. You can choose between 4 different automatic massage programs by pressing the respective auto button. Each program is designed for a 30-minute massage session.

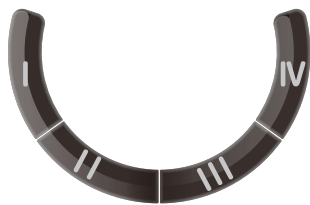

- **Auto 1 (DEEP MASSAGE)** – Alternates between all 5 manual massage modes (kneading, tapping, dual, shiatsu & rolling) for full body deep massage on acupressure points with air pressure enabled on all positions (shoulder, hip, arms, leg/foot).
- **Auto 2 (COMFORT)** – Alternates between all 5 manual massage modes while also varying the movements of each mode to provide a more fixed spot massage. Air pressure is enabled on all positions.
- **Auto 3 (RECOVERY)** – Alternates between all 5 manual massage modes. Backrest and leg/foot part recline and then incline back and forth simultaneously to help blood circulation and help boost energy.
- **Auto 4 (DECOMPRESSION)** – All 5 manual massage modes are enabled while backrest reclines to its maximum position as leg/foot part is lowered simultaneously to stretch out the leg and back muscles and decompress your entire body.

* IF YOU USE IT CONTINUOUSLY, PLEASE ENSURE TO HAVE AT LEAST 10 MINUTES TO REST IN ORDER TO LESSEN THE BURDEN ON THE BODY.

Massage programs and selections



Zero Gravity Button – If pressed once, massage chair will move to zero gravity position 1. Press again to move to zero gravity position 2. Press a third time to move to zero gravity position 3. Press fourth, massage chair will return to original position.

-Zero G1 → Zero G2 → Zero G3 → Original Position



Back Recline / Incline Button – Press the button and hold to adjust backseat position manually.

Foot Incline Button / Recline Button - Press the button and hold to adjust the footrest position manually

LCD Display Diagram

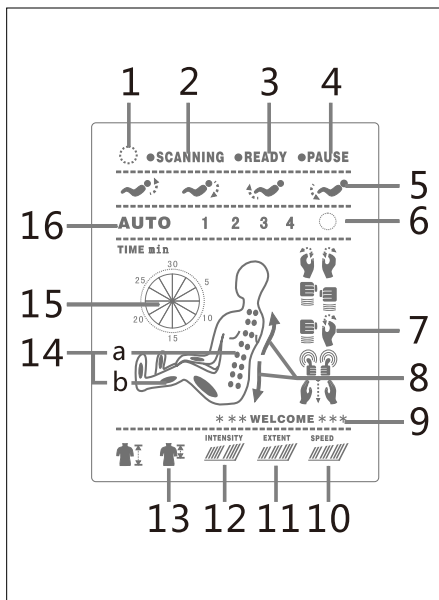

1. Massage is connected with power and is functioning
2. Massage chair is scanning the body shape
3. Massage chair scan has finished and is ready for use
4. Pause is enabled
5. Recline and foot adjust positions
6. Heating function is enabled
7. Massage method
(top to bottom – kneading, tapping, dual, shiatsu, and rolling)
8. Massage roller direction (up or down)
9. Massage chair welcome display
10. Tapping or kneading speed level adjustment
11. Width level adjustment
12. Air pressure intensity level
13. Rolling adjustment:
partial rolling adjustment and full body rolling adjustment
14. a. Roller position display
b. Air massage display
15. Massage timer
16. Auto mode is enabled (4 modes available)

Caution

To avoid accidents and malfunction of the RELAXONCHAIR™ RC-MKII Massage Chair, switch off the Main Switch and disconnect the power plug from the electrical outlet after use.

Always disconnect the power plug from the electrical outlet if the RELAXONCHAIR™ RC-MKII Massage Chair is not being used for a period of time.

Product Care and Storage, Specification

Product Care and Storage

Storing the RELAXONCHAIR™ RC-MKII Massage Chair

- Wipe off dust and dirt from the RELAXONCHAIR™ RC-MKII Massage Chair with a soft, dry cloth after use.
- Keep the RELAXONCHAIR™ RC-MKII Massage Chair clean and away from places of high humidity.
- If the RELAXONCHAIR™ RC-MKII Massage Chair is not going to be used for a long time, cover it with a dust cover and disconnect its power plug from the electrical outlet.
- Do not store the massage chair under direct sunlight or in places of high temperature. This may cause the color of the upholstery to fade.
- Do not allow the massage chair to remain in contact with vinyl or wallpaper for extended periods of time as this could lead to discoloration.

Cleaning the RELAXONCHAIR™ RC-MKII Massage Chair

- Before cleaning, ensure that the main power switch is turned off and AC plug is disconnected from the electrical outlet.
- Wipe off dust and dirt from the RELAXONCHAIR™ RC-MKII Massage Chair after use.
- The RELAXONCHAIR™ RC-MKII Massage Chair can be cleaned thoroughly with a piece of slightly damp cloth. Do not pour any liquids directly on to the chair.
- Do not iron the upholstery.
- Do not use abrasive cleaning agents like benzene or thinner to clean the RELAXONCHAIR™ RC-MKII Massage Chair. This may cause the upholstery to fade.
- Do not use a wet cloth to clean the remote controller. This may result in malfunction of remote controller.

Specification

Model: RC-MK IV

Name: Massage Chair

Rated voltage: 110-120V~ 60Hz
220-240V~ 50Hz/60Hz

Rated power input:150W

Material introduction: PVC, PA, Steel Parts and Electric & Electron Parts

MATERIAL	PU	LEATHER	CLOTH	WOOD
	✓			

RELAXONCHAIR Limited Three (3) Year Warranty

RELAXONCHAIR warrants to the original purchaser of this product that the product will be free from manufacturing defects in workmanship and material for a period of three (3) years from original date of purchase with following coverage. Original purchaser must provide proof of purchase for the warranty. :

For the 1st Year from the date of original purchase, the warranty covers all parts and labor including transportation to and from authorized repair center when on-site repair is not available.

For the 2nd year, this warranty covers defective parts or components only. The original purchaser must contact RELAXONCHAIR customer service department and provide a description of the defective part, including digital pictures if requested. RELAXONCHAIR shall supply such defective part to the original purchaser and original purchaser can repair by him or herself or choose to send the product to nearest authorized repair center. In this case, original purchaser is responsible for labor cost of the repair and transportation to and from the authorized repair center. RELAXONCHAIR shall not cover any transportation cost.

For the 3rd year, this warranty covers main structural body frame only. In the event, main structural body frame either bends or break, RELAXONCHAIR shall replace the frame. Additional Extended Warranties are available at extra cost. Please, call or email RELAXONCHAIR customer service department for additional information.

THIS WARRANTY DOES NOT COVER OR APPLY TO:

- (1) normal wear and tear items including but not limited to Velcro, Zipper, or tears in any fabric and cosmetic covers,
 - (2) damage to the product due to misuse, mishandling, and abuse,
 - (3) product not assembled or installed according to manufacturer's instructions,
 - (4) damage or loss that has occurred during shipping or transportation, any claims for such loss or damage must be addressed and resolved with the designated carrier
 - (5) accidental damage or negligence of end user such as stains, fluids, mold, water damage, animal damage, cuts, and burns,
 - (6) act of God,
 - (7) any property damage other than the product and/or economic loss of end user,
 - (8) any second-hand owner.
- This warranty is not transferrable and only applies to original purchaser. (9) any commercial use of this product voids this warranty. This product is intended for residential use only.

Warranty Claim Procedure: You can reach RELAXONCHAIR customer service department either by email us at help@relaxonchair.com or Call us at 866-647-3496. Customers must provide proof of purchase for any warranty claim. Repair Order Number shall be assigned once we receive your claim. Authorized repair center will not accept any repair without Repair Order Number. This warranty gives you specific legal rights. You may also have other rights that vary from state to state.

RELAXONCHAIR®

Customer Care Center at (866) 647-3496

Representatives are available

Mon.~ Fri. 9:00 A.M.~ 5:00 P.M.(PST).

help@relaxonchair.com

THANK YOU

We sincerely appreciate your business. We hope that you are pleased with your purchase and would love to hear from you!

Please submit a review so that we have feedback on how we are doing. We highly value our customer's satisfaction and strive to provide only the best products for our customers. Every week we randomly select reviews we received from our customers and send a free gift valued at \$50.00 to those selected.

Review Steps

1. Log into your Amazon account.
2. Go to your orders. Click on "Write a product review" and give us your rating
3. Please write your review.

Best Regards,
Relaxonchair Customer Service
www.relaxonchair.com



Cut

Mailing Address RELAXONCHAIR
*post stamp required PO. BOX 871
BREA, CA 92822-0871

Fold along the line

WARRANTY REGISTRATION CARD

Name: _____

Address: _____

Phone number: _____

E-mail: _____

Model name: _____

Model number: _____

Purchase price: _____ Purchase from: _____

Date purchased: _____

Your Message: