

# RELAXONCHAIR®

## RC-MK CLASSIC

# USER MANUAL

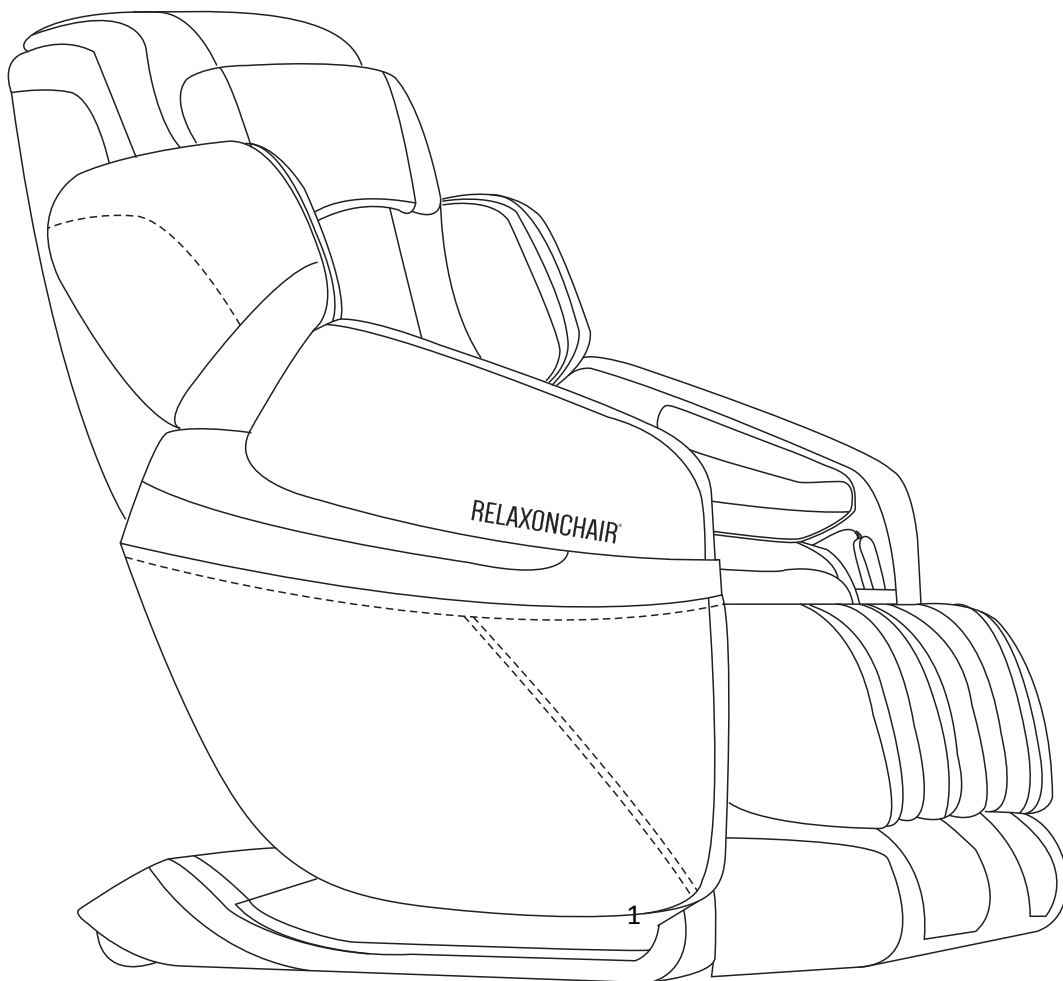

# RELAXONCHAIR

## MK-CLASSIC Massage Chair

Congratulations and thank you for trusting RELAXONCHAIR. You are about to discover the many joys of owning a premium RELAXONCHAIR™ MK-CLASSIC Massage Chair. Massage, combined with healthy eating, exercise and a good sleep regimen, is a great way to take care of your body & mind, leading to a happy, productive lifestyle.

For many years, RELAXONCHAIR has been the trusted source for quality massage products that improve your life. The RELAXONCHAIR™ MK-CLASSIC Massage Chair represents our heritage of delivering amazing, quality products since the beginning. It is covered by our exclusive 3 year limited warranty. Take comfort in knowing our quality engineering team goes the extra mile every day, to make sure our customers rarely need it.

We believe you are going to love this chair. If so, please tell others how it has changed your life. If we have somehow let you down, please tell us directly. Continuous feedback from our customers, either loving the products or helping us to improve them, is critical to RELAXONCHAIR's success.

To communicate directly with us, please contact the RELAXONCHAIR Customer Care Center at (866) 647-3496. Representatives are available to assist you Monday through Friday from 9:00 A.M. to 5:00 P.M. (Pacific Time). You could also email us anytime at [help@relaxonchair.com](mailto:help@relaxonchair.com)

Sincerely yours,

RELAXONCHAIR Product Development Team

## CONTENTS

<i>Safety, cautions and warnings</i>	4
<i>Names of parts and functions</i>	10
<i>Preparation on before use</i>	12
<i>Massage programs and selections</i>	14
<i>Product care and storage</i>	17
<i>Trouble shooting</i>	18
<i>Warranty</i>	20



*Before you start using your RELAXONCHAIR™ MK-CLASSIC Massage Chair, please read this operation manual thoroughly to learn about the correct methods of usage, especially the section on safety. This manual should be kept on hand for easy reference. It is your guide to safe and efficient operation.*

# Safety, Cautions and Warnings

## IMPORTANT SAFETY INSTRUCTIONS

When using the RELAXONCHAIR™ MK-CLASSIC Massage Chair, basic precautions should always be followed, including the following: Read all instructions before using the RELAXONCHAIR™ MK-CLASSIC.

**DANGER** – To reduce the risk of electric shock:

- Always unplug this RELAXONCHAIR™ MK-CLASSIC Massage Chair from the electrical outlet immediately after using and before cleaning.
- Never use pins or other metallic fasteners with this appliance.
- Carefully examine the covering before each use. Call for service if the covering shows any sign of deterioration on, such as blistering, peeling or cracking.
- Keep dry – Do not operate in wet or moist conditions.



**WARNING** – To reduce the risk of burns, fire, electric shock or injury to persons:

*READ ALL INSTRUCTIONS BEFORE USING.*

1. RELAXONCHAIR™ MK-CLASSIC Massage Chair should never be left unattended when plugged in. Unplug from the outlet when it is not in use and before putting on or taking of parts.
2. Close supervision is necessary when this RELAXONCHAIR™ MK-CLASSIC Massage Chair is used by or near children or disabled persons. Keep children away from reclining backrest and extended leg rest.
3. Use this RELAXONCHAIR™ MK-CLASSIC Massage Chair only for its intended use as described in this manual. Do not use attachments not recommended by the manufacturer.
4. Never operate this RELAXONCHAIR™ MK-CLASSIC Massage Chair if it has a damaged cord or plug, if it is not working properly, if it has been dropped or damaged, or dropped into water. Contact RELAXONCHAIR™ Customer Service at **(866) 647-3496**.
5. Do not carry this RELAXONCHAIR™ MK-CLASSIC Massage Chair by the power cord or use cord as a handle.
6. Keep the cord away from heated surfaces.
7. Never operate the RELAXONCHAIR™ MK-CLASSIC Massage Chair with the air openings blocked. Keep the air openings free of lint, hair and the like.
8. Never drop or insert any object into any opening.
9. Do not use outdoors. RELAXONCHAIR™ MK-CLASSIC Massage Chair is intended for indoor only.
10. Do not operate where aerosol (spray) products are being used or where oxygen is being administered.
11. To disconnect, turn all control to the off position, to remove the plug from the outlet.
12. Do not stand on or in the MK-Classic Massage Chair. Use only while seated properly.
13. Product is not intended for use by children or persons with reduced physical, sensor or mental capabilities, or lack of experience and knowledge unless they have been given supervision or instruction concerning use of the product by a person responsible for their safety.

# Safety, Cautions and Warnings

14. Children should be supervised and ensure that they do not play with the product.
15. Use heat feature carefully. It may cause serious burns. Do not over use if you have sensitive skin or if you have poor blood circulation. The repeated use of heat by children or disabled persons may be dangerous. Check the skin in contact with the heated area of the appliance frequently to reduce the risk of blistering.
16. Do not crush – avoid sharp folds.
17. Keep children away from extended foot support (or other similar parts).
18. NEVER REMOVE COVER.
19. Connect this appliance to a properly grounded outlet only. See grounding instructions.

## SAVE THESE INSTRUCTIONS

This RELAXONCHAIR™ MK-CLASSIC Massage Chair is intended for household use only.

### 1. Usage Environment

- Do not use the RELAXONCHAIR™ MK-CLASSIC Massage Chair in an excessively humid or dusty environment as this may result in malfunction or electric shock.
- Do not use the RELAXONCHAIR™ MK-CLASSIC Massage Chair in a room with a temperature of 104° For higher.
- Do not expose the RELAXONCHAIR™ MK-CLASSIC Massage Chair to heater, stoves or direct sunlight.
- Place and use the RELAXONCHAIR™ MK-CLASSIC Massage Chair on an even, non-slip floor.
- The RELAXONCHAIR™ MK-CLASSIC Massage Chair is designed for home use and not for commercial purposes.



#### Caution

The RELAXONCHAIR™ MK-CLASSIC Massage Chair is to be used indoors only.

If you use the RELAXONCHAIR™ MK-CLASSIC Massage Chair in a cold room, do not increase the room temperature abruptly. It is recommended that you increase the temperature gradually to a normal level.

If the RELAXONCHAIR™ MK-CLASSIC Massage Chair is stored in a cold place and is being brought into a warm environment, it is advisable to wait one hour before use. This is because its performance may not be at optimum level as there may be water droplets on the mechanical parts due to condensation.

Using the RELAXONCHAIR™ MK-CLASSIC Massage Chair under such conditions may result in malfunction.

# *Safety, Cautions and Warnings*

## 2. Safety Precautions

1. To ensure safe and correct use of the RELAXONCHAIR™ MK-CLASSIC Massage Chair, do not operate it without reading this operation manual carefully.
2. Do not use the RELAXONCHAIR™ MK-CLASSIC Massage Chair when the upholstery or seat is removed. This may cause injury or malfunction.
3. Do not use the RELAXONCHAIR™ MK-CLASSIC Massage Chair with other therapeutic equipment or electric blanket etc. as this may result in ineffectiveness or injury.
4. Do not use the RELAXONCHAIR™ MK-CLASSIC Massage Chair an hour before or after eating as this may have adverse effects on the user.
5. Do not allow children or pets to play around the RELAXONCHAIR™ MK-CLASSIC Massage Chair, such as behind the backrest, under the seat or leg rest of the RELAXONCHAIR™ MK-CLASSIC Massage Chair. This may result in injury.
6. Do not rest or place heavy objects on the armrests, leg rest or backrest as this may result in malfunction or injury.
7. Do not use the RELAXONCHAIR™ MK-CLASSIC Massage Chair when your body is wet.
8. Do not operate the RELAXONCHAIR™ MK-CLASSIC Massage Chair with wet hands.
9. It is not recommended to use the massage for more than 30 minutes.
10. Do not perform continuous massage on the same spot of your body for more than 5 minutes at a time as this may result in excessive stress on your muscle and may have adverse effects.
11. Do not insert your hand or foot along the paths of the massage rollers during use as this may cause injury.
12. Stop operation immediately if you experience any discomfort.
13. This product is not intended for self-treatment of conditions that should be managed by a qualified health care provider.
14. People on medication or with medical conditions, please consult your doctor before use.
15. Remove all scarves, neckties, necklaces and jewelry, watch before using the massager.
16. Please do not use the product if you are not feeling well.

# Safety, Cautions and Warnings

## 3. People with Medical conditions

Consult your doctor before use if you:

- Are under medical rest as ordered by a doctor.
- Have spinal disorders, an abnormal spinal cords or have suffered a spinal injury.
- Have back problems.
- Have diabetes, osteoporosis or sensory impairment.
- Have joint dysfunction.
- Have a pacemaker or other electronic medical devices.
- May be pregnant.
- Have phlebitis or thrombosis.
- Have an increased risk for blood clots.
- Had recent surgery.
- Have surgical pins, screws, or anything mechanical implanted in your body.



### Caution

- The RELAXONCHAIR™ MK-CLASSIC Massage Chair is not intended for use by children or persons with reduced physical, sensory or mental capabilities, or lack of experience and knowledge, unless they have been given supervision or instruction concerning use of the RELAXONCHAIR™ MK-CLASSIC Massage Chair by a person responsible for their safety.
- Children should be supervised to ensure that they do not play with the RELAXONCHAIR™ MK-CLASSIC Massage Chair.
- Avoid using the RELAXONCHAIR™ MK-CLASSIC Massage Chair under the influence of alcohol.
- Do not apply massage rollers directly on the head, elbow or knee joints, torso or abdomen.
- If your legs or feet slip off the leg rest during massage, do not force them back in as this may result in injury.
- Remove the power plug from the electrical outlet immediately should liquid be accidentally spilled onto the RELAXONCHAIR™ MK-CLASSIC Massage Chair Do not use wet hands to connect or disconnect the power plug from the electrical outlet.
- Do not tamper with the power cord or use the RELAXONCHAIR™ MK-CLASSIC Massage Chair with a damaged cord as this may result in malfunction and/or electric shock.

# *Safety, Cautions and Warnings*

**4. Instances when the RELAXONCHAIR™ MK-CLASSIC Massage Chair should not be used** In the following events, please switch off the main power switch immediately and disconnect the power cord from the electrical outlet:

- If water is accidentally spilled onto the RELAXONCHAIR Chair. This may result in electric shock or malfunction.
- If the fabric of the backrest is torn and the internal components are exposed.
- If pain or discomfort is felt during massage, stop operation immediately and consult with your doctor.
- If you detect any malfunction or any other abnormal condition during operation.
- If there is a power outage. Injury may occur when power is restored unexpectedly.
- If there is lightning.

## **5. Assembly and repair of the RELAXONCHAIR™ MK-CLASSIC Massage Chair**

Do not attempt to disassemble the RELAXONCHAIR™ MK-CLASSIC yourself unless instructed to do so by RELAXONCHAIR's Technical Support Team. Touching the internal components may result in malfunction or electric shock.

RELAXONCHAIR™ MK-CLASSIC Massage Chair must be serviced or repaired by authorized service center.

## **6. Things to note about the power plug and cord**

- Check that the Alternating Current (AC) voltage corresponds with the specification indicated for the RELAXONCHAIR™ MK-CLASSIC Massage Chair.
- Do not connect or disconnect the power plug from the electrical outlet with wet hands. This may result in malfunction or electric shock.
- When disconnect the power plug, pull it by holding the plug, not the cord.
- Although operation will be stopped automatically by the Auto Function always remember to switch off the main power switch after use.
- Do not place the power cord under the RELAXONCHAIR Chair or any other heavy objects.
- Do not wind the power cord around the RELAXONCHAIR Chair as this may damage the cord and result in a fire or electric shock.
- Do not operate the RELAXONCHAIR™ MK-CLASSIC Massage Chair with a damaged cord or extension cord.
- Do not use the RELAXONCHAIR™ MK-CLASSIC Massage Chair if the electrical outlet is loose.
- If the power cord is damaged, it should be replaced by a qualified technician.



# Safety, Cautions and Warnings

## 7. Grounding instruction

- This product must be grounded. If it should malfunction or break down, grounding provides a path of least resistance for the electric current to reduce the risk of electric shock. This product is equipped with a cord or an equipment-grounding conductor and a grounding plug. The plug must be plugged into an appropriate outlet that is properly installed and grounded in accordance with all local codes and ordinances.
- Danger – Improper connection of the equipment-grounding conductor can result in a risk of electric shock. Check with a qualified electrician or service technician if you are in doubt as to whether the product is properly grounded. Do not modify the plug provided with the product – if the supplied plug does not fit the outlet; have a proper outlet installed by a qualified technician. This product is for use on a nominal 120V circuit and has a grounding plug that looks like the plug illustrated below. Make sure the product is connected to an outlet having the same configuration as the plug. No adopter should be used with this product.

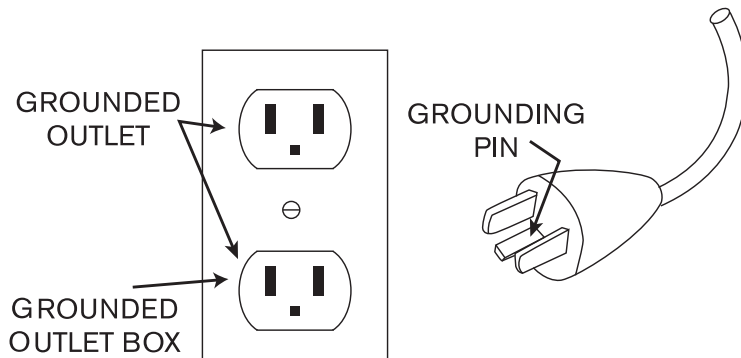

# Name of Parts & Functions

## OVERVIEW

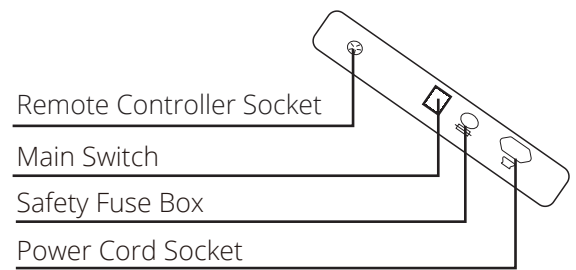
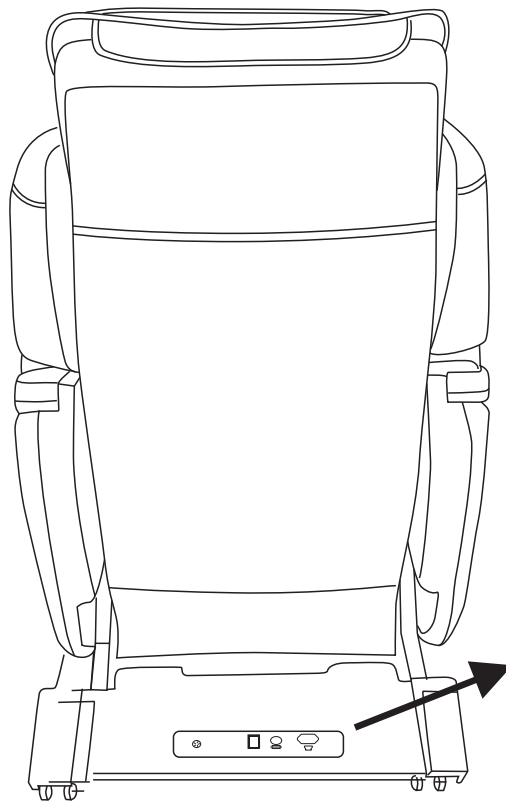
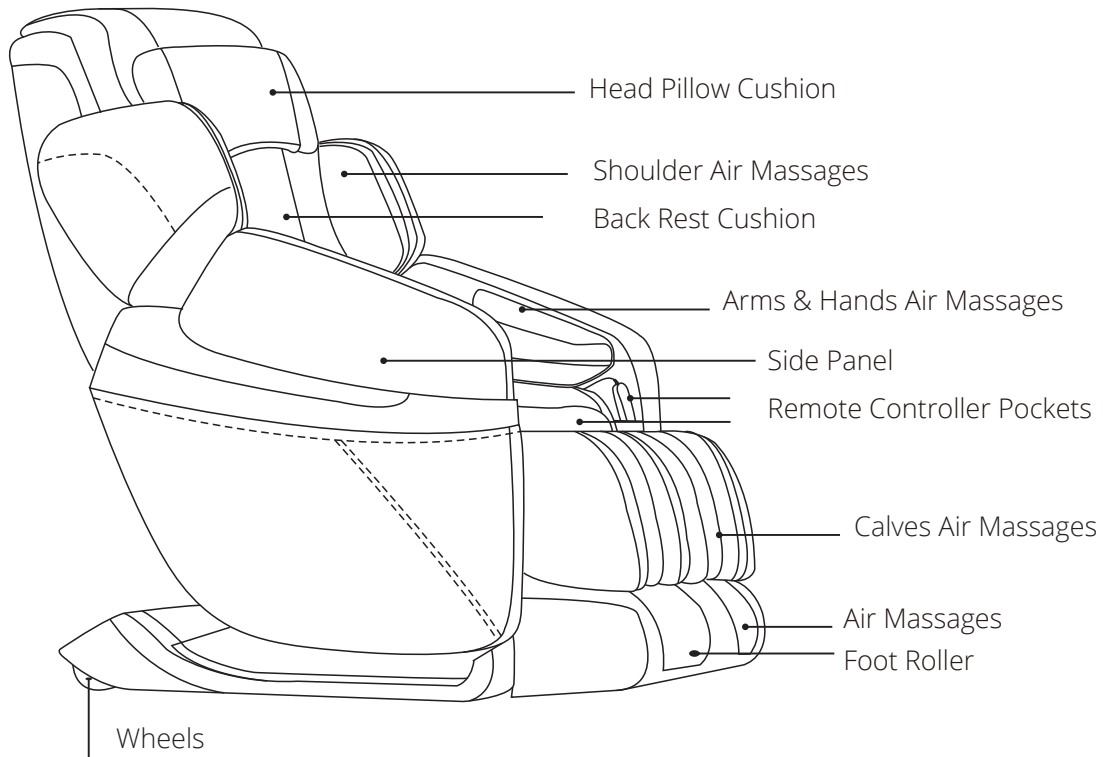

# Name of Parts & Functions

## REMOTE CONTROLLER

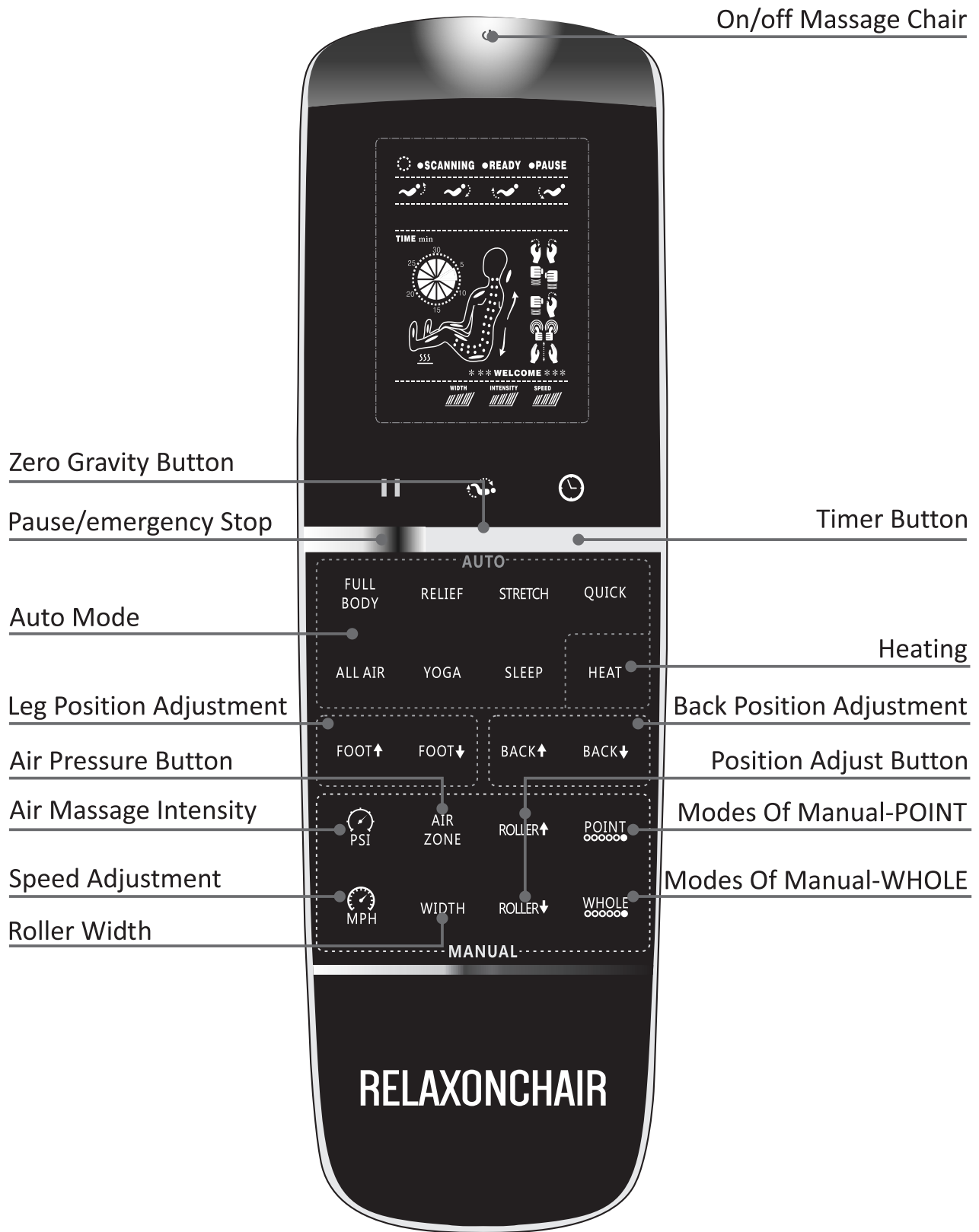

# Preparation Before Use

## REMOVE THE PACKAGE & GET OUT THE ALL PARTS

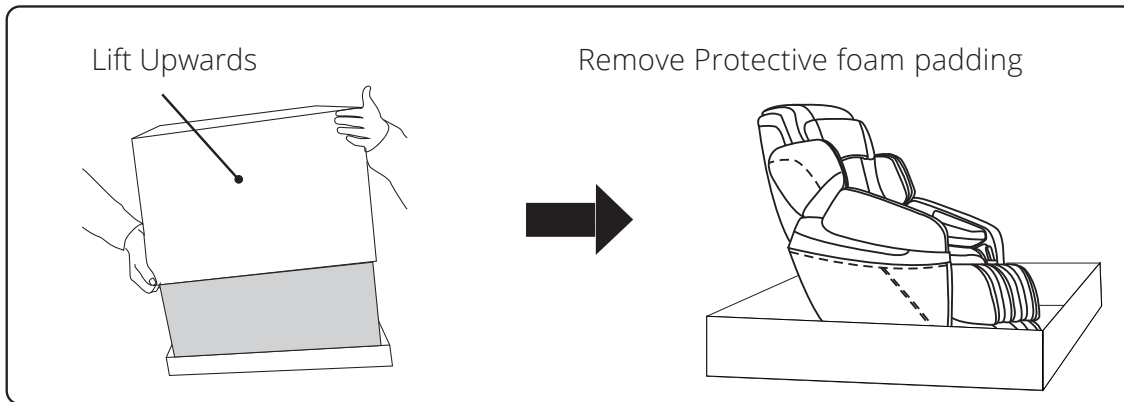

- Remove the carton
- Take out the foam.
- The spare parts include: remote control, user manual, power cord.

### 1. Moving the RELAXONCHAIR™ MK-CLASSIC Massage Chair

- Hold the back of the RELAXONCHAIR™ MK-CLASSIC Massage Chair and push downward to recline the chair to approximately a 45° Angle.
- Roll it to desired position, using the rollers located at the rear bottom of the chair. Gently place the chair on the floor.

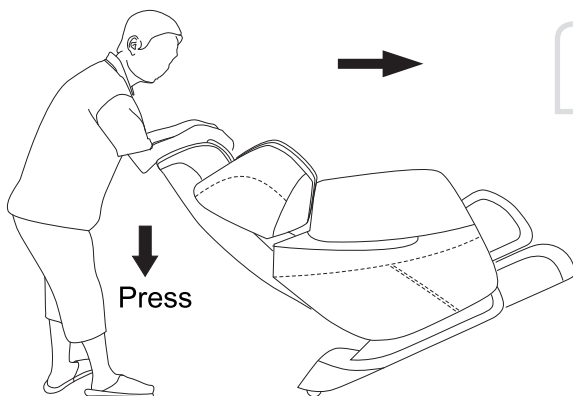

#### Caution

- Disconnect all wires and cords including power cords & remote controller before you move the RELAXONCHAIR™ MK-CLASSIC Massage Chair.
- Do not move the RELAXONCHAIR™ MK-CLASSIC Massage Chair when there is someone on it. This will cause the RELAXONCHAIR™ MK-CLASSIC Massage Chair to tip over resulting in accident and injuries.

# Preparation Before Use

## 2. Positioning Massage Chair

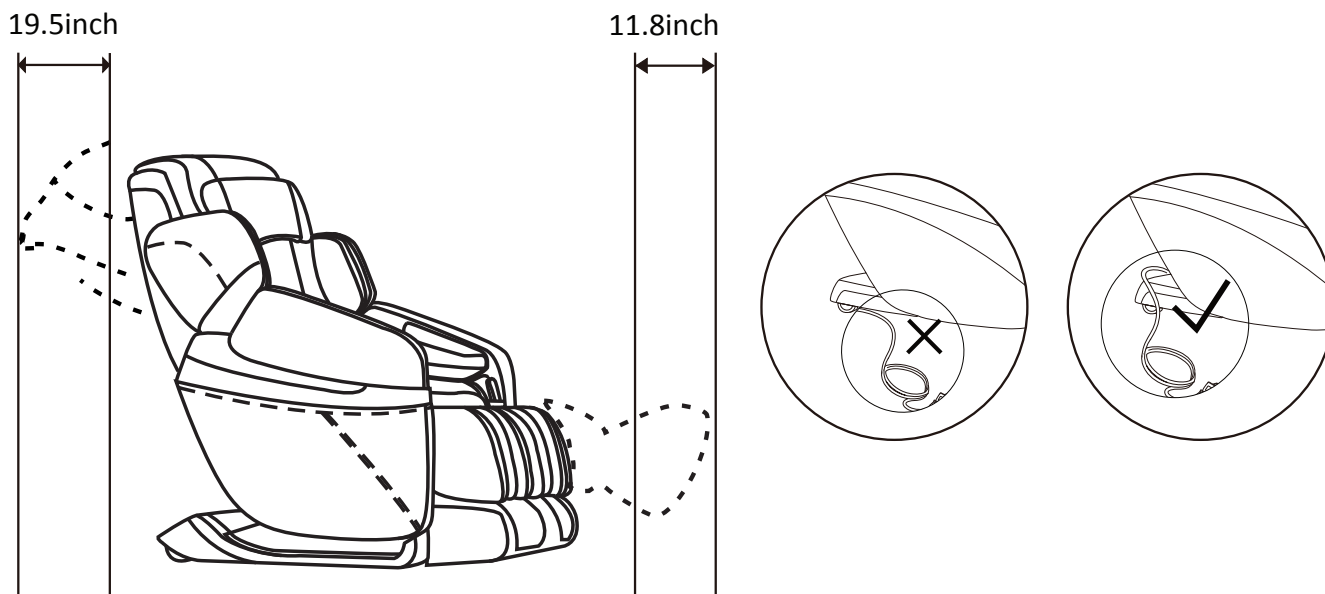

Double check preparation steps, smooth out any creases in the cushions Place the massage chair in an open area

## 3. Power On/Off

- Connect the main power cord located in the back of the chair to standard 110V electrical outlet.
- Turn On/Off the main power switch located at the back of the RELAXONCHAIR™ MK-CLASSIC Massage Chair to power the chair On/Off. (Illustration)

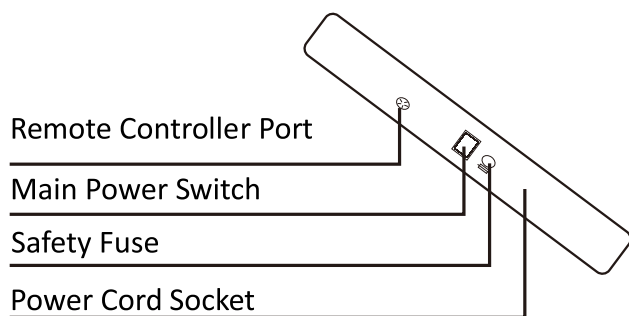

- Ensure the power cord is not placed under the RELAXONCHAIR™ RC-CLASSIC Massage Chair.
- Ensure all switches are turned "OFF" including the main power switch before connect the power cord to an electrical outlet

# Massage Programs & Selections

## OPERATION GUIDE

### DESCRIPTION OF BUTTON FUNCTIONS

#### DISPLAY DIAGRAM

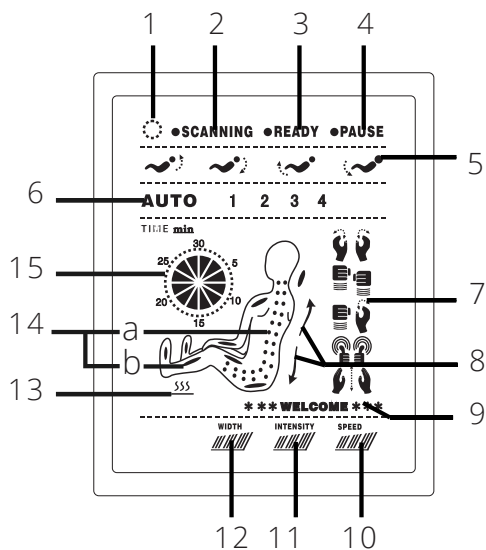

1. Massage chair is powered on.
2. Massage chair is scanning the back contour and preparing for initiation.
3. Scanning is complete and ready for massage programs.
4. Pause button has been pressed and chair is temporarily stopped.
5. Reclining position adjustment buttons.
6. Displays which automatic program is activated.
7. Displays which massage technique is activated at the time.
8. Depicts the direction of the massage rollers, moving upwards or downwards.
9. Cheerful greeting from your massage chair.
10. Shows the massage speed level.
11. Shows the air intensity level.
12. Shows massage roller width.
13. Heating function is on.
14. Two indicators:
  - a. Roller Position Display
  - b. Air-Squeeze Position Display
15. Depicts time remaining in current massage program.

# Massage Programs & Selections

## OPERATION GUIDE

### DESCRIPTION OF BUTTON FUNCTIONS



#### Start or Stop massage chair

- Press this button to turn the massage chair ON.
- Press this button again to turn massage chair OFF. Massage function will stop and the massage chair will come back to the original position. When the chair returns to the original position the chair will completely shut off and all buttons will be inactive.



Press once to temporarily **pause or stop** all the massage functions. Chair will enter idle mode. Press again to resume massage.



#### Time

Press to increase the massage time in increments of 5 minutes. The default working time is 15 minutes. The maximum working time is 30 minutes.



#### Position adjustment area

Press this button to move the back and leg position. Press once for Zero G1, twice for Zero G2, three times for Zero G3 and four times to return to the original position.

**Zero G1 " Zero G2 " Zero G3 " Original Position**



Press the button and hold on to adjust the massaging position of backrest independently



Press the button and hold to adjust the footrest independently

# Massage Programs & Selections

## OPERATION GUIDE

### DESCRIPTION OF BUTTON FUNCTIONS

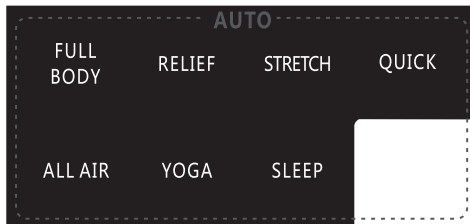

#### Auto Mode

This chair is designed with 7 auto massage modes.

FULL BODY • RELIEF • STRECH • QUICK • FULL AIR • YOGA • SLEEP

#### Manual Mode



#### Point

This button allows you to target certain areas for your back massage.

UpperBack > Lower Back > Buttocks > Upper & Lower Back > Lower Back & Buttocks > Whole Back & Buttocks



#### Whole

This button allows you to choose Manual Massage Mode for your back

Kneading > Tapping > Dual Mode > Shiatsu > Rolling > Off



#### Speed

Press to cycle through three levels of speed, 3 Levels Speed Adjustment

Tapping / Kneading / Dual Action / Shiatsu Foot Roller / Calf Kneading



#### Width

Press once to adjust the width of the rollers.



#### Roller Location

Press and hold the up or down arrows to move the massage rollers to the desired area.



When used with point button, you can customize your target area by creating customized target area pressing these buttons.



#### Air

Press this button for different combinations of air massage.



#### Intensity

Control the air bags intensity - 3 levels



#### Heat

Press to turn heating function on & off.



# Product Care & Storage

## AFTER USE & MAINTENANCE



1. After the massage program is completed, return chair to upright position by pressing the On/Off button. Before pressing:

- Make sure surrounding area is clear.
- Keep arms and legs away from gaps between the armrest, leg rest, and footrest, to prevent possible injury.

ON/OFF



2. Then press the power button to turn off the massage chair and bring it back upright. Once done, return remote controller to the storage pocket in the front of the chair by the users knee.

ON



3. Turn off the main power switch.

4. Remove plug from power outlet.

Do not pull on the power cord to remove the plug.

5. Do not unplug with wet hands.

## Maintenance

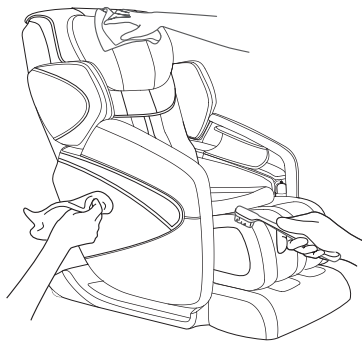

- Turn off and unplug the chair before cleaning.
- Use a dry, neutral colored cloth or soft bristled brush to lightly wipe the chair.
- Do not use water liquids or any other to clean the chair.

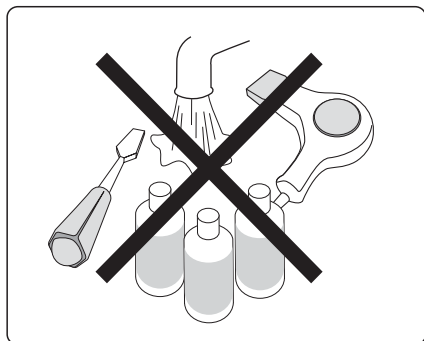
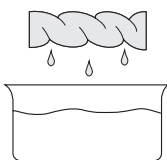
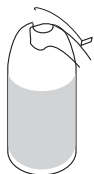

# Trouble Shooting

You may experience the following noises or feeling when in massage, as being due to the mechanical design, they will not have any effect on the operation of the unit and the product life.



- A “clatter” noise occurs when the knead balls go up and down
- A “creak” noise of the gear and the motor occurs while in massage
- A friction noise occurs when the knead balls rub the cover cloth
- A rattling noise occurs while in the “Tap” or “Knead and Tap” massage movements (particularly when the massage moves from the shoulders to the back).
- In the “Knead”, “Tap”, or “Knead and Tap” massage movements, massaging speed may vary with the knead balls’ strength changed.
- A roaring noise of the motor occurs when load is given to the chair
- A “cuckoo” noise occurs while in the auto mode course, the knead balls are automatically adjusted to the back-and-forth position to have the chair fitting in with the user’s body shape.
- The compressor’s noise and the air exhausting noise occur while in air-massage.
- A noise occurs when the air bag is inflated
- A noise occurs while in massage of the shoulders
- A grinding noise occurs when the backrest is reclined
- There is a humming sound from the pump



## Warning

Absolutely do not modify, disassemble or repair by yourself. Negligence may cause fire or mechanical trouble of the chair which may result in hazard on the body.

# Trouble Shooting

PROBLEMS	CHECK POINTS	TROUBLESHOOTING
The unit does not start up.	Check whether the switch has been turned on.	Turn on the switch.
	Check whether the  button on the remote controller has been pressed.	Press the  button on the remote controller.
	No massage function has been selected.	Select a massage function.
	Check whether there is poor connection between the power plug and the receptacle.	Ensure good connection between the power plug and the receptacle.
Different height of the left and right knead balls.	A mechanism is used to allow two knead balls tapping alternatively.	This is normal and does not come from the trouble of the chair.
Sudden noise rises during operation.	Check whether the unit has been in operation for too long.	Turn off the power and stop the operation. Restart the unit after 30-min break.
Sudden cease of operation.	The rated operating time has elapsed.	Turn off the power and stop the operation. Restart the unit after 30-min break.
The reclined backrest fails to return its stored position when  is pressed.	Excessive use of the unit.	Turn off the power and stop
	The rated operating time has elapsed.	the operation. Restart the unit after 30-min break.
The power indicator fails to light up after the power switch is turned on.	Check whether there is poor connection between the power plug and the receptacle.	Ensure good connection between the power plug and the receptacle.
	Whether the circuit breaker is tripped off.	Restore the circuit breaker. If the problem re-occurs after the circuit breaker is restored, please contact us.



## Caution

After checking, if the problem is caused by none of the above, switch off the power, unplug the power cord, and contact your dealer or our service center for repairs.

Prior to operating the unit when it has not been used for a long period of time, read this manual carefully and make sure that the unit is still in good condition to avoid accident or injury.

## Specification

Model: RC-MK CLASSIC

Name: Massage Chair

Rated voltage: 110-120V~ 60Hz    
220-240V~ 50Hz/60Hz

Rated power input:150W

Packaging Dimension

Qty 1

N.Weight 218 Lbs

G.Weight 293 Lbs

Size 57(L)\*34(W)\*50(H) Inch

Color Brown Gray

Material introduction: PVC, PA, Steel Parts and Electric & Electron Parts

MATERIAL	PU	LEATHER	CLOTH	WOOD
				

# WARRANTY CARD

## RELAXONCHAIR [MK- CLASSIC] Limited Three (3) Year Warranty

RELAXONCHAIR warrants to the original purchaser of this product that the product will be free from manufacturing defects in workmanship and material for a period of three (3) years from original date of purchase with following coverage. Original purchaser must provide proof of purchase for the warranty: **For the 1st Year** from the date of original purchase, the warranty covers all parts and labor including transportation to and from authorized repair center when on-site repair is not available. **For the 2nd year**, this warranty covers defective parts or components only. The original purchaser must contact RELAXONCHAIR customer service department and provide a description of the defective part, including digital pictures if requested. RELAXONCHAIR shall supply such defective part to the original purchaser and original purchaser can repair by him or herself or choose to send the product to nearest authorized repair center. In this case, original purchaser is responsible for labor cost of the repair and transportation to and from the authorized repair center. RELAXONCHAIR shall not cover any transportation cost. **For the 3rd year**, this warranty covers main structural body frame only. In the event, main structural body frame either bends or break, RELAXONCHAIR shall replace the frame. Additional Extended Warranties are available at extra cost. Please, call or email RELAXONCHAIR customer service department for additional information.

### THIS WARRANTY DOES NOT COVER OR APPLY TO:

(1) normal wear and tear items including but not limited to Velcro, zipper, or tears in any fabric and cosmetic covers, (2) damage to the product due to misuse, mishandling, and abuse, (3) product not assembled or installed according to manufacturer's instructions, (4) damage or loss that has occurred during shipping or transportation, any claims for such loss or damage must be addressed and resolved with the designated carrier, (5) accidental damage or negligence of end user such as stains, fluids, mold, water damage, animal damage, cuts, and burns, (6) act of God, (7) any property damage other than the product and/or economic loss of end user, (8) any second-hand owner. This warranty is not transferable and only applies to original purchaser (9) any commercial use of this product voids this warranty. This product is intended for residential use only.

**Warranty Claim Procedure:** You can reach RELAXONCHAIR customer service department either by email us at [help@relaxonchair.com](mailto:help@relaxonchair.com) or

Call us at 866-647-3496. Customers must provide proof of purchase for any warranty claim. Repair Order Number shall be assigned once we receive your claim. Authorized repair center will not accept any repair without Repair Order Number. This warranty gives you specific legal rights. You may also have other rights that vary from state to state.

**RELAXONCHAIR**

---

# WARRANTY CARD

## RELAXONCHAIR [MK- CLASSIC] Limited Three (3) Year Warranty

Please return filled bottom portion by email or mail and print a copy for personal records.

Name: \_\_\_\_\_ Purchase Date: \_\_\_\_\_

Address: \_\_\_\_\_

Phone Number: \_\_\_\_\_ Email: \_\_\_\_\_

Model Name: \_\_\_\_\_ Purchase Price: \_\_\_\_\_

Purchased from: \_\_\_\_\_ Date purchased: \_\_\_\_\_

Your message: \_\_\_\_\_

Mail to: **RELAXONCHAIR** 720 E. Debra Lane, Anaheim, CA 92805