



100 - 240V

Information subject to change without notice



OVERVIEW

ORDERING INFORMATION

FIXTURE OVERVIEW

SolaFrame 1000 fixture is the go-to workhorse automated framing fixture for lighting designers. With 20,000 lumen output, full framing shutters, rotating and fixed gobo wheels, a redesigned CMY and CTO color mixing system, replaceable color wheels, and animation effects. It has a feature set as varied as your lighting designs. The SolaFrame 1000 is a star performer in all professional production environments.

APPLICATIONS

- Arenas and stadiums
- Concert halls and performing arts centers
- Film and television broadcast studios
- Megachurches and houses of worship
- Nightclubs and special events

PRODUCT FEATURES

- White LED Engine
- 480 W Ultra-Bright engine producing 20,000 field lumens or a High CRI Engine featuring incredibly accurate color rendering
- Full framing shutter system
- CMY / CTO - Linear color mixing system
- Six plus open position replaceable color wheel
- Iris and Light Frost
- Rotating Prism
- Sharp edge focus throughout 12°–40° zoom range
- Eight position plus open interchangeable Gobo Wheel
- Seven position plus open Rotating Gobo Wheel
- Continuously rotating variable Animation Wheel
- TM-30 Filter boosts Ultra-Bright engine to 85+ CRI
- Patented Lens Defogger

SolaFrame 1000

Model	Description
2570A1200	SolaFrame 1000 fixture, Ultra-Bright, black, with Road Case
2570A1200-B	SolaFrame 1000 fixture, Ultra-Bright, black, with Molded Rubber Insert
2570A1200-F	SolaFrame 1000 fixture, Ultra-Bright, black, with Styrofoam Packaging
2570A1201	SolaFrame 1000 fixture, High CRI, black, with Road Case
2570A1201-B	SolaFrame 1000 fixture, High CRI, black, with Molded Rubber Insert
2570A1201-F	SolaFrame 1000 fixture, High CRI, black, with Styrofoam Packaging

Color Options: Fixtures ship standard in black. White available by request.

Notes: Fixture includes two (2) Omega Brackets, one (1) fixture power cord, Bare Ends to powerCON TRUE1™ Input, Safety cable

Accessories

Model #	Description
2560B7009	Fixture Power Cord upgrade, 5-15 Edison to powerCON TRUE1, 15 A
2560B7005	Fixture Power Cord upgrade, Stage Pin to powerCON TRUE1, 20 A
2560B7006	Fixture Power Cord upgrade, L6-20 to powerCON TRUE1, 20 A
2560B7007	Fixture Power Cord upgrade, L5-20 to powerCON TRUE1, 20 A
67040007	MegaClaw™
55040014	Cheeseborough 2" Alloy 1/2 Coupler Truss Clamp
67040010	Mini-Claw™



PRODUCT SPECIFICATIONS

Source

Engine Options	Ultra-Bright white engine	High CRI white engine
LED Details	480 W	480 W
Max Lumens on the Wall	20,000 Lumens	16,000 Lumens
LPW	42 Lumens per Watt	34 Lumens per Watt
LED Life	50,000 hours	50,000 hours
Native CCT	7000 K	6000 K

Color

Color Mixing	Cyan, Magenta, Yellow, CTO-Linear
Color Temperature	Variable down to 2800 K
Color Wheel	Six (6) interchangeable dichroic chips plus open includes TM-30 Filter standard
Notes	See Page 5 for color rendering information

Optical

Beam angle range	12°–40°
Gate size	25 mm
Aperture size	108 mm
Pattern Projection	Rotating and indexable wheel with seven (7) patterns plus open Fixed wheel with eight (8) patterns plus open
Prism	Three-facet rotating and indexable prism Additional accessories available
Frost	Light frost Additional accessories available
Flicker control/Hz range	2.4 kHz or 16 kHz
Animation	Rotating animation wheel LED Branch Animation
Iris	16 Blade Iris
Notes	See page 3 for additional gobo information

Control

Input method	DMX (5-pin) or Ethernet
Protocols	DMX via RS-485 Art-Net or sACN via Ethernet
Modes (Footprint)	One (49)
RDM functions	Yes
UI type	Full color graphical UI with 6 button navigational control
Local control	Yes
Dimming performance	16-Bit, DMX Controlled

Electrical

Voltage range	100–240 V 50–60 Hz
Input method	powerCON TRUE1
Max Wattage	900 W
Max Current	9.1 A
Notes	See Page 6 for power factor information

Thermal

Ambient operating temp	-10°–45° C (14°–113° F)
Fan	Three Modes: Standard, Studio, and Continuous
Stationary dBA/Full intensity	Standard - 42.8 dBA Background noise measured at 39.5 dBA

Physical

Pan and Tilt Range	540° Pan, 265° Tilt
Max Pan/Tilt Speed	2.64 sec for 540°, 1.5 sec for 265°
Materials	Steel and aluminum frame with molded plastic covers
Color options	Black, White by request
Mounting options	Any orientation
IP rating	IP20
Weight	69.9 lb / 31.3 kg
Included accessories	powerCON TRUE1 to bare end fixture tail Two (2) clamp brackets Safety cable
Notes	See page 6 for dimensions

Warranty

Fixture Warranty	Five (5) years for light engine Two (2) years for complete fixture
Warranty Details	https://www.highend.com/warranty/

Regulatory & Compliance

Approved Regulatory Standards	Listed to UL 1573 Certified to CSA STD. C22.2 No: 166 CE EAC
CE Compliance declared to the following standards	Safety: EN 60598-1, EN 60598-2-17 EMC: EN 55015, EN 61547, EN 61000-3-2, EN 6100-3-3
Complies to the ROHS Directive	Yes

Safety

Safety	Minimum distance to illuminated surface = 2.0 m Minimum distance from fixture head to combustible materials = 0.1 m
--------	--

Notes about LED luminaires

All LED sources experience some lessening of light output and some color shift over time. LED output will vary with thermal conditions. Thermal conditions can be affected by ambient temperatures and orientation.



OPTICAL INFORMATION

Fixed Gobo Dimensions

Outside Diameter	30 mm (1.18 in)
Image Diameter	24 mm (0.95 in)
Materials	0.5 mm Aluminum

Rotating Gobo Dimensions

Outside Diameter	30 mm (1.18 in)
Image Diameter	24 mm (0.95 in)
Materials	0.5 mm Aluminum or 1.1 mm Glass Borofloat

Interchangeable Color Wheel

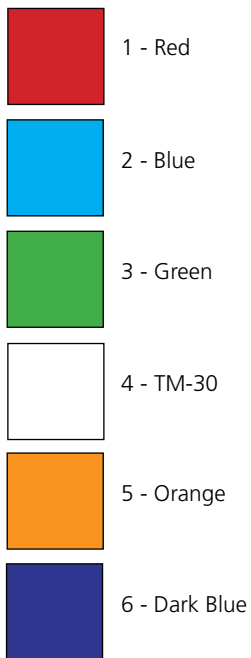

Fixed Gobo Wheel

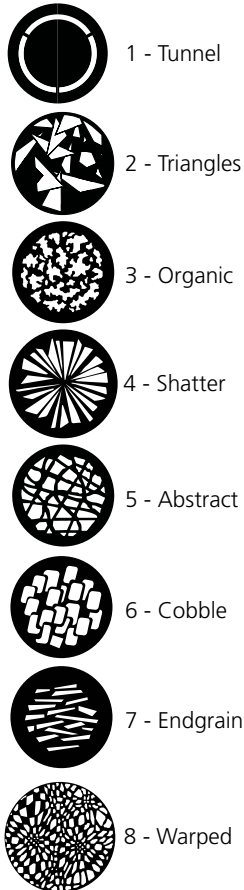

Rotating Gobo Wheel

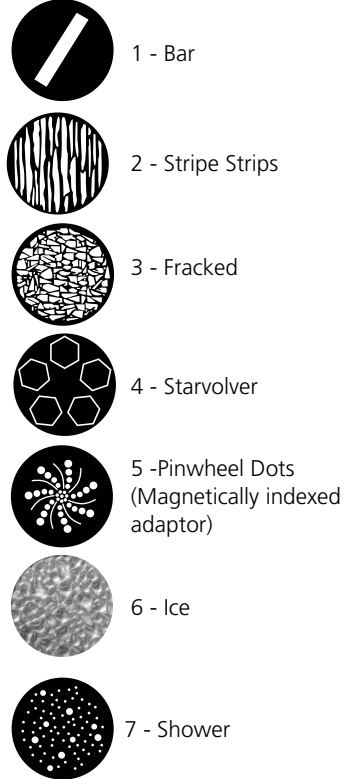

Animation Wheel

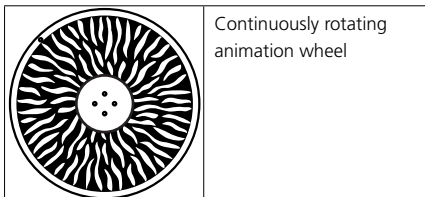



PHOTOMETRIC INFORMATION

SolaFrame 1000 - Ultra-Bright

Mode	Degree	Candela	Field Lumens	Power Consumption	Lumens Per Watt
Narrow	12	607,900	18,000	480 W	37
Medium	30	113,400	20,000	480 W	41
Wide	40	78,600	20,000	480 W	41
Wide w/ Frost	42	62,880	16,000	480 W	33

SolaFrame 1000 - High CRI

Mode	Degree	Candela	Field Lumens	Power Consumption	Lumens Per Watt
Narrow	12	405,300	14,500	480 W	25
Medium	30	75,606	16,000	480 W	31
Wide	40	52,100	16,000	480 W	31
Wide w/ Frost	42	41,680	13,000	480 W	25

Narrow Zoom - 12 Degrees

Throw Distance (d)	10 ft	15 ft	20 ft	25 ft	188.7 ft
	3.0 m	4.6 m	6.1 m	7.6 m	57.5 m
Field Diameter	2.1 ft	3.1 ft	4.2 ft	5.3 ft	39.6 ft
	0.65 m	0.97 m	1.29 m	1.61 m	12.1 m
Illuminance (fc)	6,079	2,733	1,537	984	18
Illuminance (lux)	65,400	29,400	16,538	10,584	186

Narrow Zoom - 12 Degrees

Throw Distance (d)	10 ft	15 ft	20 ft	25 ft	188.7 ft
	3.0 m	4.6 m	6.1 m	7.6 m	57.5 m
Field Diameter	2.1 ft	3.1 ft	4.2 ft	5.3 ft	39.6 ft
	0.65 m	0.97 m	1.29 m	1.61 m	12.1 m
Illuminance (fc)	4,053	1,801	1,014	649	12
Illuminance (lux)	43,600	19,378	10,900	6,976	123

Medium Zoom - 30 Degrees

Throw Distance (d)	10 ft	15 ft	20 ft	25 ft	188.7 ft
	3.0 m	4.6 m	6.1 m	7.6 m	57.5 m
Field Diameter	5.3 ft	8.0 ft	10.7 ft	13.4 ft	101.1 ft
	1.64 m	2.46 m	3.27 m	4.09 m	30.83 m
Illuminance (fc)	1,023	455	256	164	3
Illuminance (lux)	12,198	5,421	3,050	1,952	34

Medium Zoom - 30 Degrees

Throw Distance (d)	10 ft	15 ft	20 ft	25 ft	188.7 ft
	3.0 m	4.6 m	6.1 m	7.6 m	57.5 m
Field Diameter	5.3 ft	8.0 ft	10.7 ft	13.4 ft	101.1 ft
	1.64 m	2.46 m	3.27 m	4.09 m	30.83 m
Illuminance (fc)	682	303	171	110	2
Illuminance (lux)	8,132	3,614	2,033	1,301	22

Wide Zoom - 40 Degrees

Throw Distance (d)	10 ft	15 ft	20 ft	25 ft	188.7 ft
	3.0 m	4.6 m	6.1 m	7.6 m	57.5 m
Field Diameter	7.3 ft	11.0 ft	14.6 ft	18.2 ft	137.3 ft
	2.22 m	3.33 m	4.44 m	5.55 m	41.87 m
Illuminance (fc)	786	350	197	126	3
Illuminance (lux)	8,450	3,756	2,112	1,352	24

Wide Zoom - 40 Degrees

Throw Distance (d)	10 ft	15 ft	20 ft	25 ft	188.7 ft
	3.0 m	4.6 m	6.1 m	7.6 m	57.5 m
Field Diameter	7.3 ft	11.0 ft	14.6 ft	18.2 ft	137.3 ft
	2.22 m	3.33 m	4.44 m	5.55 m	41.87 m
Illuminance (fc)	521	232	131	84	2
Illuminance (lux)	5,600	2,489	1,400	896	16

To determine center beam illumination in footcandles at any throw distance, divide candela by the throw distance squared.

To determine center beam illumination in footcandles at any throw distance, divide candela by the throw distance squared.



COLOR METRIC INFORMATION

Ultra-Bright Engine

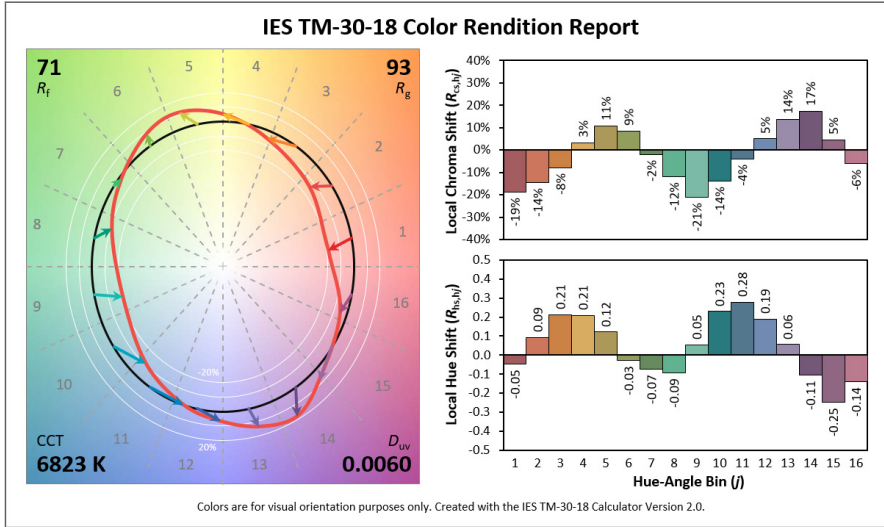

Additional Color Metrics

SolaFrame 1000 Ultra-Bright Engine	
CRI R _a (R _g)	70 (-39.5)
TLCI	47

High CRI Engine

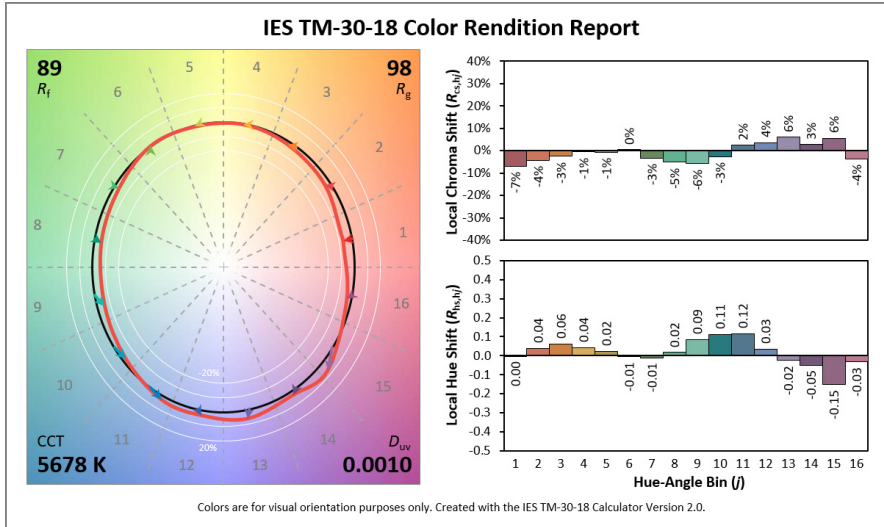

Additional Color Metrics

SolaFrame 1000 High CRI Engine	
CRI R _a (R _g)	90 (52.6)
TLCI	89



PHYSICAL INFORMATION

SolaFrame 1000 Dimensions

MODEL	HEIGHT		WIDTH		DEPTH		WEIGHT	
	in	mm	in	mm	in	mm	lb	kg
SolaFrame 1000*	28.6	726	18.1	460	12.7	324	69.9	31.3
SolaFrame 1000 in Box	31.3	795	25.2	640	23.6	600	84.2	38.2
SolaFrame 1000 in Molded Case Insert	28.1	715	23.6	600	22	560	105.2	47.7
SolaFrame 1000 in Roadcase	36.6	929	22.3	565	23.6	600	185.9	84.3

*Does not include mounting hardware

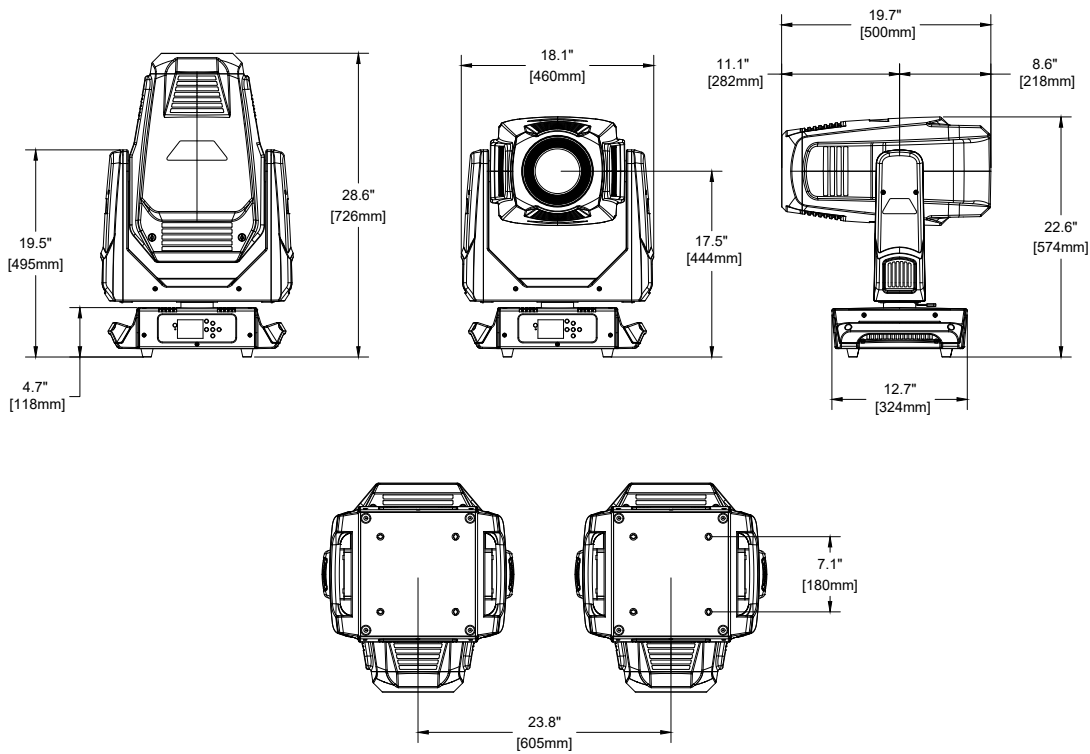

SolaFrame 1000 Power Table

VAC	Amps	Hz	Watts	VA	PF
100	9.0	50	900	925	0.99
120	7.5	60	900	907	0.99
200	4.6	50	896	926	0.96
208	4.3	60	869	896	0.97
220	4.0	50	834	869	0.95
240	3.7	60	837	875	0.95



ADDITIONAL ORDERING INFORMATION

Additional Accessories

MODEL	DESCRIPTION
H7500001	Extra Omega Brackets
H7300105	Galvanized Safety Cable w/Spring Snap

Molded Case Insert Dimensions

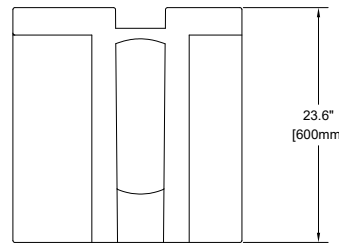
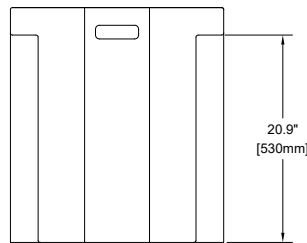
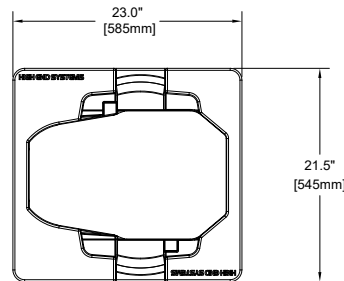
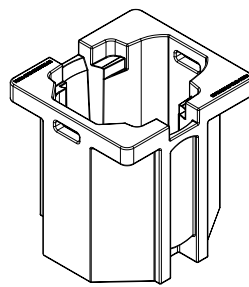

Roadcase Dimensions (Single Mode)

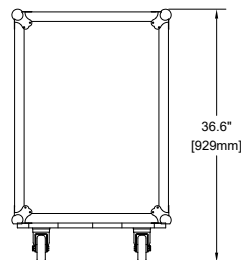
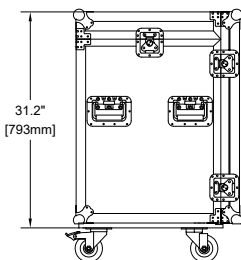
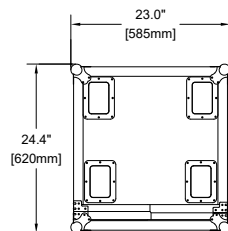

(Dual Mode)

