

SPARK RAIN PRO

SF-01

USER MANUAL



CONTENTS

1 PRODUCT INTRODUCTION	A2
1.1 PRODUCT OVERVIEW	A2
1.2 PRODUCT ACCESSORIES	A3
1.3 SPARK FABRICA GRANULE	A3
2 TECHNICAL PARAMETER	A4
3 SCREEN OPERATION GUIDE	A5
3.1 BACK PANEL INTRODUCTION	A5
3.2 MENU SETTING	A6
3.3 STATUS ICONS	A7
3.4 RDM	A7
3.5 DMX PARAMETER LIST	A7
4 OPERATION NOTES	A8
4.1 WORKING CONDITION REQUIRED	A8
4.2 SAFETY TIPS	A9
5 MACHINE OPERATION	A10
5.1 PREPARATION	A10
5.1.1 INSTALL MACHINE	A10
5.1.2 FILL IN SPARK FABRICA GRANULE	A11
5.2 CONNECT MACHINE	A11
5.3 INITIAL SETTING	A13
5.3.1 SET CHANNEL MODE	A13
5.3.2 SET DMX ADDRESS	A13
5.4 START TO SPARK	A14
5.4.1 TURN ON CONSOLE'S POWER	A14
5.4.2 TURN ON HEATING FUNCTION	A14
5.4.3 ADJUST SPARKING HEIGHT	A14
5.4.4 ADJUST SPARKING DENSITY	A15
5.4.5 SPARK THROUGH REMOTE CONTROLLER	A15
5.5 CLEAR MATERIAL	A16
5.6 CLEAN MACHINE	A16
6 MACHINE MAINTENANCE	A16
7 FAILURE HANDLING	A17

DISCLAIMER

Please read the manual carefully before installing and using this product. Failure to read or comply with this manual may result in injury to products and personnel, and Spark Fabrica shall not be responsible for this.

This product is a professional machine, we do not assume any responsibility for accidents or losses caused by the use or maintenance of this product by personnel without professional training and permission.

If the information contained in the manual or the product specifications are changed, Spark Fabrica will not inform you further and responsible for any errors or omissions.

Our company reserves the right to modify the user manual at any time.

PREFACE

*This manual includes warning, caution and notice concerning the safe operation of equipment. These warning-caution and notice come with the following icons. Please read them carefully!

⚠ WARNING

This warning indicates a dangerous situation that may result in death or serious injury if not avoided.

⚠ CAUTION

This alert indicates a dangerous situation that may result in mild or moderate injury if not avoided.

NOTICE

This means that you need to be careful.

1. PRODUCT INTRODUCTION

This product belongs to special effects equipment, only for professional use.

This product belongs to the cold fireworks simulation special effects equipment, using CST technology, heating special metal powder, and sparking silver spark fountain which is safer than the traditional cold fireworks,It has three controllable variables: height, density and duration.

This product is widely used in weddings, concerts, sports events, event meetings and so on,Stimulate your interest and light up your activity.

1.1 PRODUCT OVERVIEW

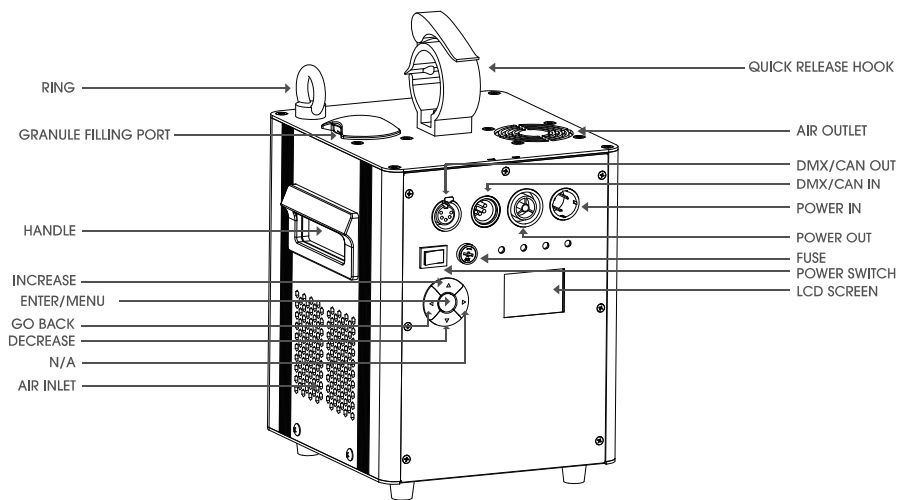

1.2 PRODUCT ACCESSORIES

1.6 Meter Power Plug
3 Meters Power Pair Cable
3 Meters DMX Pair Cable
Upload Box (Optional)
User Manual
Safety Rope

NOTICE

Open the package carefully and check to make sure the goods are in good condition.

1.3 SPARK FABRICA GRANULE

A special metal powder has the characteristics of high content, little residue, belonging to a special consumables with no smoke, odor and other harmful gas when sparking.

WARNING

Only the consumables provided by Spark Fabrica are allowed to be used. Spark Fabrica shall not be liable for any damage to machines, personnel and property caused by the use of consumables not provided by the company.

2 TECHNICAL PARAMETER

Identification	Manufacturer	SPARK FABRICA
	Name	SPARK RAIN PRO
	Model	SF-01
AC Power	Input Voltage & Frequency	100-120V, 50 / 60HZ 200-240V, 50 / 60HZ
	Current Limiter Specifications	6.3A,100-120V / 6.3A,200-240V
	Constant Current	5.5A,100-120V / 2.7A,200-240V
	Nominal Total Power Consumption	600W
	Power Input Connector	SEETRONIC
	Power Output Connector	SEETRONIC
	DMX Signal Interface	5PIN
Heating	Heat Up Time	<5 Minutes
Hopper	Powder Tank Capacity	150g
	Removable Hopper	N/A
Technical Parameters	Lineary Adjustable Density	30-100%
	Adjustable Height	3-8m
	Height Level	1-10 Level
	Powder Consumption (100% Output)	20-25g/Minute
	Maximum Single Continuous Duration	30s
Control	Control Protocol	DMX-512
	RFID Proximity Card	√
	RDM	√
	CAN	√
	SMPTE	Touch Screen Console Support
Accessory	Power Plug	SEETRONIC (1.6Meter)
	Remote Controller	Optional
	DMX Cable	√ 3Meter
	Power Cable	√ 3Meter
	Safety Ring	√
	Safety Rope	√
	Bottom Mounting Screw	×
	Software Upgrade Box	Optional
120ohms Terminal Resistance	Optional	
Certification	CE	√
	ROHS	√
Weight	Net Weight	8kg
	Gross Weight	10kg
Dimensions	Machine Dimensions - L*W*H	215mm*213mm*257mm
	Packing Dimensions - L*W*H	270mm*250mm*330mm
Granule	Granule	Spark Fabrica Granule

3 SCREEN OPERATION GUIDE

3.1 BACK PANEL INTRODUCTION

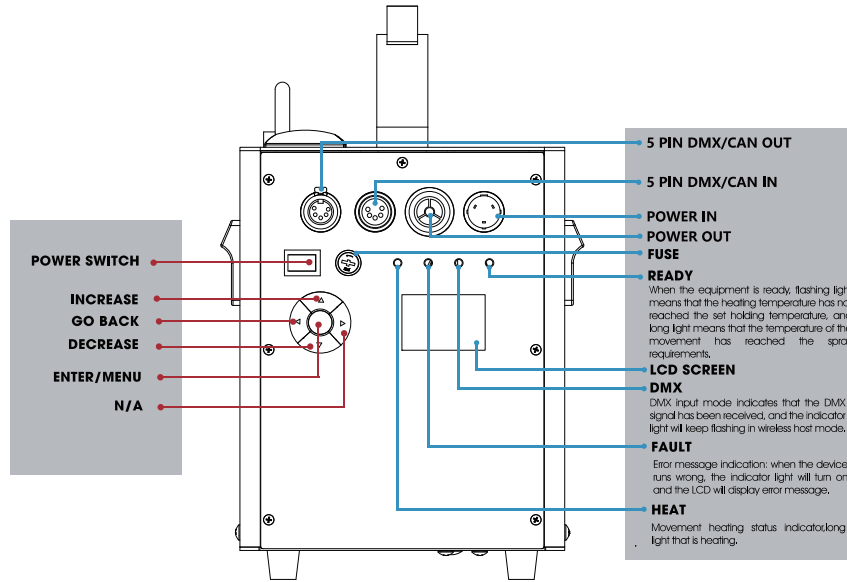

3.2 MENU SETTING

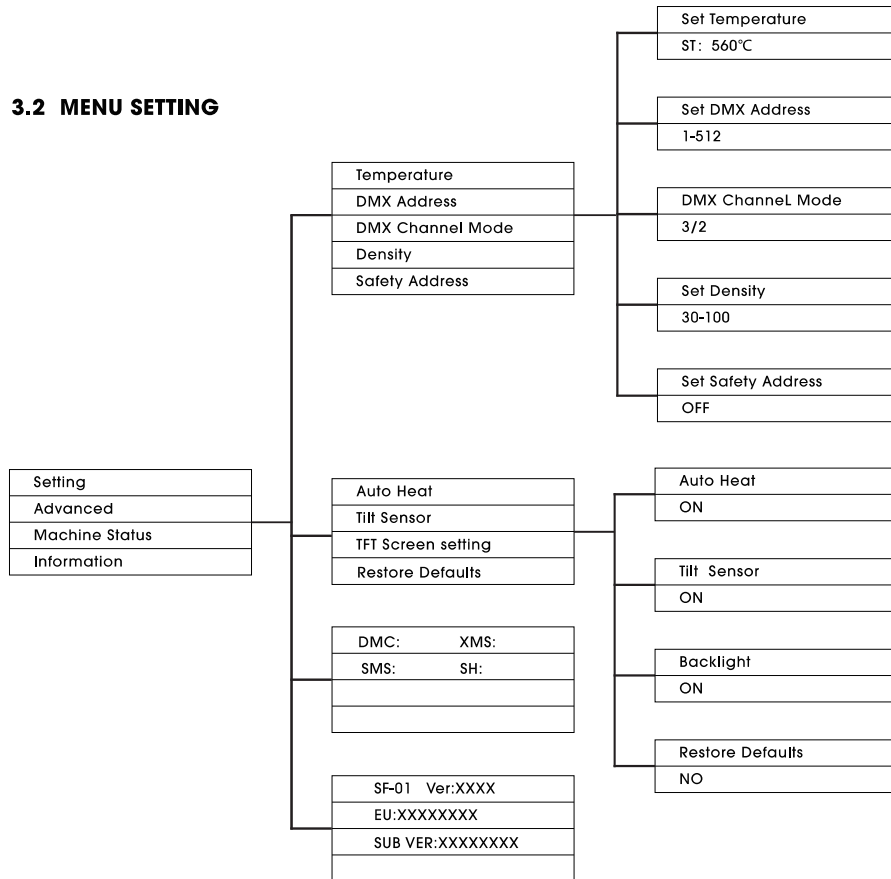

NOTICE

Press <OK> to enter the menu setting. The screen will automatically return to the main state interface with no modification.

NOTICE

Press ▲ key or ▼ key to modify parameters. The parameters will be flash after the modification, and please press <OK> key to save the change.

NOTICE

Press ◀ key will return to previous page.

3.3 STATUS ICONS

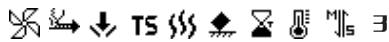

NOTICE

When the icons are green means the machine is working normally, and yellow means abnormal.

	Blower Motor	TS	Temp Sensor Unconnected
	Shaff Motor		Temp Over Heat
	Hopper Motor		Tip Over
	Lack Of Time		Sub PCB Connected
	PCB Too Hot		2/3 Channel Mode Optional

3.4 RDM

RDM allows the console with RDM function to set the DMX address and starting temperature of Spark Jet Pro.

3.5 DMX PARAMETER LIST

First Channel	Function
0~10	Stop
11~255	Fountain Height 1~25
Second Channel	Function
0~200	Pre-heat Off
11~39	Emergency Stop
56~200	Clear Material
240~255	Pre-heat On
Third Channel	Function
0~255	Density Adjustment (0 is Maximum Density)
Safty Channel	Function
0~200	Control Off
201~255	Control On

4 OPERATION NOTES

Please read the following Operation Notes carefully before working with the machine.

4.1 WORKING CONDITION REQUIRED

⚠ WARNING

Do not mount the product on a flammable surface (linoleum, carpet, wood, paper, carton, plastic, etc). Make sure there are no inflammable or combustible materials in the using environment.

⚠ WARNING

Do not use in a confined space. Always install the product in a location with adequate ventilation, at least 20 in (50 cm) from adjacent surfaces.

⚠ WARNING

This product has no lightning arrester, please do not use this product in thunderstorm weather.

⚠ WARNING

Keep people or flammable materials at least 10 feet (3 meters) away from the machine, and make sure that debris does not fall on flammable objects.

⚠ WARNING

Do not use the machine at temperature above 122 °F (50 °C).

4.2 SAFETY TIPS

⚠ WARNING

Always connect the ground wire to avoid electric shock. The machine cannot be submerged in water while operating it.

⚠ WARNING

Do Not touch the sparks. During heating up and operation, do not touch the housing.

⚠ WARNING

Ensure nothing drop(s) into the nozzle of Spark Rain Pro unit. Do Not cover output nozzle port.

⚠ WARNING

The product is very hot during operation and it remains hot for a long time after operation has stopped. Do not touch or put finger in the output nozzle.

⚠ WARNING

Make sure that children, unauthorized people and animals do not obtain access to the machine.

⚠ WARNING

The noise level generated from the spark machine unit is estimated at 80dB depending on the point nearest to the machine(s) during operational discharge mode.

⚠ WARNING

Wear eye protection to avoid eye injury while filling granules and testing spark machine(s).

⚠ WARNING

The proper firefighting extinguishers are recommended as follows: Any type of sand or substance that can suffocate the active metals. Class "D" Fire Extinguishers for Metal Substance Fires.

5 MACHINE OPERATION

5.1 PERPARATION

Install the machine on a firm and level truss, and the maximum tilt angle shall not exceed 15 degrees.

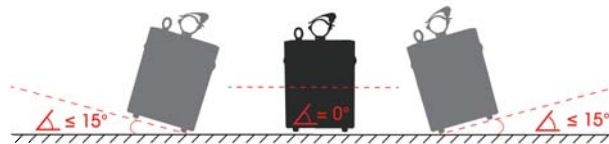

5.1.1 INSTALL MACHINE

Install the product on truss by using the attached accessories.



⚠ WARNING

Keep people or flammable materials at least 10 feet (3 meters) away from the machine, and make sure that debris does not fall on flammable objects.

*Specific installation notes please refer to "4 OPERATION NOTES".

5.1.2 FILL IN SPARK FABRICA GRANULE

Spark Fabrica Granule is the consumable specially designed for spark machine, to simulate cold fountain fireworks effect for stage.

*Tear the vacuum package of granule, and fill in the Spark Fabrica Granule through the granule filling port on the top of the machine.

*Fill the consumable into the feed port, NOT into the output nozzle.

*Close the lid securely after filling.

*The capacity of storage bin is 150g.

**WARNING**

Make sure to fill the Spark Fabrica Granule through the feed port on the top of the fixture when power supply is off.

WARNING

Wear eye protection to avoid eye injury while filling granules and testing spark machine(s).

5.2 CONNECT THE MACHINE

Connect power and DMX signal line.

*Connect the first machine's power plug.

*Connect the other machines in series with the power cable.

*Connect the other machines in series with DMX connection line.

*Connect PYRO SIM CONTROLLER or DMX512 controller.

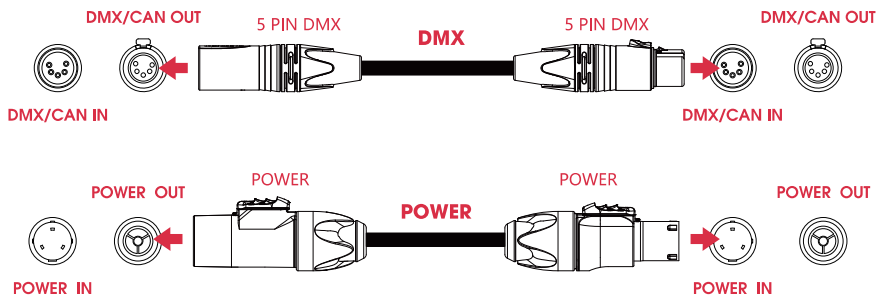

WARNING Do not use damaged power plug and power cable. One power plug is recommended to connect 4 units in series at most for this product.

CAUTION Please attach the configured 120 ohm terminal resistor to the outlet of the last machine to enhance the anti-interference of the machine.

CAUTION Please calculate all products' total current required according to the power supply and fuse parameters of the products.

NOTICE The standard length of the power connection line and the signal connection line is 3 meters, and a longer length can be reached by connecting in series.

5.3 INITIAL SETTING

Setting	Range	Default
Set Temperature	400-620	560
DMX Address	1-512	1
DMX Channel Mode	3/2	3
Density	30-100	100
Safety Address	0-512	OFF(0)
Tilt Sensor	ON/OFF	ON
Restore Defaults	YES/NO	NO
TFT BackLight	ON/OFF	ON
Auto Heating	ON/OFF	ON

***Turn on power**

***Check the machine status icon(refer to icon introductions of 3.3)**

CAUTION

When the icon shows yellow, it indicates that the machine is abnormal. Please use it after asking the professional to check and repair the machine.

*The sparking temperature of the machine is the factory default temperature. The product will heat up automatically when disconnected with DMX signal. Automatic heating function can be set to on or off, and the concrete operation please refer to "3.2 MENU SETTING".

*When spark machines connect DMX signal, the heating function can be started only on the Sim Pyro Console.

5.3.1 SET CHANNEL MODE

CAUTION

This machine has 2 channel mode and 3 channel mode, the specific setting please refer to "3.2 MENU SETTING".

5.3.2 SET DMX ADDRESS

Please set DMX address according to channel mode:

*In the 2 channel mode, please set spark machines' DMX address to 1.3.5.7.....

*In the 3 channel mode, please set spark machines' DMX address to 1.4.7.10.....

NOTICE

Please do not set address code repeatedly.

5.4 START TO SPARK

The machine can be controlled by Pyro Sim Controller console or DMX512 console.

5.4.1 TURN ON THE CONSOLE' POWER

5.4.2 TURN ON HEATING FUNCTION

NOTICE

The heating function of the second channel DMX value is 240~255, and it takes about 5 minutes to preheat after turning on.

NOTICE

When heating is turned on, the <HEAT> indicator light on the machine will turn to red, and the <READY> indicator light flashes green to indicate that the machine is heating.

NOTICE

Heating will complete after the <READY> indicator light turns green for a long time, and the spark machine will enter sparking status.

NOTICE

When using the Pyro Sim Controller controller, the screen will display the real-time temperature of each machine. When the temperature value of the control board turns green, it means that the heating is completed and the machine enters the status of sparking.

5.4.3 ADJUST SPARKING HEIGHT

Adjust sparking height through the first channel, and the height adjustment values is DMX parameter values 11-255.

WARNING

Do Not touch the sparks or put finger in the output nozzle.

WARNING

During heating up and operation, do not touch the housing.

WARNING

Keep a minimum distance of 10 ft (3 m) from the machine to the nearest human or flammable material. And make sure no falling residue fly to flammable material.

WARNING

The maximum height of indoor and outdoor granule is different. The maximum height of indoor granule is 3.5 meters, while outdoor granule is 5 meters.

NOTICE

If spark machines are affected by wind, sparking height will be reduced, sparking direction will also be affected by the wind and inclined.

NOTICE

The proper firefighting extinguishers are recommended as follows: Any type of sand or substance that can suffocate the active metals. Class "D" Fire Extinguishers for Metal Substance Fires.

5.4.4 ADJUST SPARKING DENSITY

This product has independent sparking density adjustment function. Machine's sparking density can be controlled during sparking, which can offer you more special effects choices for show.

NOTICE

The third channel is density adjustment channel, and the density is 30-100%. The default sparking density is 100%, and the density adjustment parameter values are 0-255. 0 means 100% density, and bigger DMX number means lower density.

5.4.5 SPARK THROUGH REMOTE CONTROLLER

- * Turn on the power, and leave DMX signal disconnected.
- * Hold "▲" for 2 seconds in the first interface until the screen shows "Control Pair Remoter 315M".
- * Press on remote controller until the screen shows "Code Success", it means the coding is successful.
- * One remote controller is recommended to control 4 units at most.

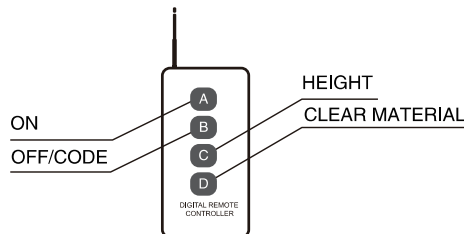
**CAUTION**

The remote controller can be used after coding when DMX signal is disconnected, or the function will be broken.

CAUTION

Sparking stops automatically after 30 seconds, and clearing material stops after 5 seconds.

CAUTION

The remote controller has 4 height levels.

5.5 CLEAR MATERIAL

This product has the function of cleaning material, which can clean up the heated but not sparked consumables, so as to avoid nodulation in the heating chamber and causing stuck machine.

NOTICE

Use the cleaning function of the second channel for cleaning, DMX value is 56-200.

NOTICE

This function must be performed at the end of each show.

5.6 CLEAN MACHINE

After clearing material, please clean the machine to extend the service life of the machine.

*Turn off the machine's power.

*Remove power connection and DMX signal cable.

*Use a damp cloth to remove dust and debris from the surface of the machine.

*Unused Spark Fabrica Granule should be stored in a cool, dry place, vacuum packed in sealed foil bags, and protected from moisture, heat, hot surface, open fire and other ignition sources.

WARNING

The product is very hot during operation and it remains hot for a long time after operation has stopped.

CAUTION

To eliminate unnecessary machine wear and improve its lifespan, unplug the power of the machine during the period of not-in-use. Never power off the product by pulling or tugging on the power cord.

6 MACHINE MAINTENANCE

Some steps are needed in order to clean and maintain the product for maximum usage. The recommended procedure is as follows:

CAUTION

After a period of using, check if there is any consumable accretion inside the nozzle. Do necessary cleaning up if there has some, or it may affect spark performance, even damage the machine.

7 FAILURE HANDLING

Error Code	Description	Solution
System Error E0 Storage Fail	System Error: Storage Fail	Replace main board
Motor Protect E1 M1	Blower motor protection/ disconnected	1.Restart machine to clear alerts,stop operating for 15 minutes until temperature return to normal. 2.Check wire connection of motor 3.Replace motor 4.Replace main board
Motor Protect E1 M2	Shaft motor protection/ disconnected	1.Shaft motor clog (perform clean material function manually) 2.Check wire connection of motor 3.Replace motor 4.Replace main board
Motor Protect E1 M3	Hopper motor protection/ disconnectd	1.Hopper motor clog (perform clean material function manually) 2.Check wire connection of motor 3.Replace motor 4.Replace main board
Temp Sensor E2 Unconnected	Temperature sensor disconnected	1.Check wire connection of temperature sensor 2.Replace Temperation sensor 3.Repalce Main board
PCB Too Hot E3	Main board too hot	Stop operating machine until main board temperature return to normal
Time Remain E4	Insufficient time	Please scan new RFID card
Temp Over Heat E5	Heating protection due to over-temperature.	Stop operating machine until temperature return to normal, Alert will clear off automatically.
Heat Fail E6	Heating process fail	1.Inspect Wire connection of heating board. 2.Replace heating coil 3.Replace heating board
Tip Over E7	Tip over alert	Machine will activate tip over protection if the angle is more than 45 degrees. The alert will clear off automatically after put the machine back to normal position.
Sub PCB Unconnected E8	Sub-PCB disconnected	1.Check wire connection of Sub-PCB 2.Replace Sub-PCB 3.Replace Main Board
Illegal Card Machine Locked	Machine locked because of using illegal or copy RFID card.	Use illegal or copy RFID card will lock the machine. If so ,seller will stop providing warranty and after sale service. To unlock the machine,please contact seller.

Spark Fabrica

www.sparkfabrica.com



| marketing@sparkfabrica.com

| +86 138 7585 1139