



Finely Crafted Pilates Equipment



Finely Crafted
Pilates Equipment



06 For Professionals by Professionals

08 Finely Crafted Pilates Equipment

11 Research & Development

14 Reformer

20 Reformer with Tower

22 Reformer Combo

26 Trapeze Table - Cadillac

29 Interchangeable Tower System

30 EPS System

31 F2 System

32 Wunda Chair

36 Spine Corrector

38 Arm Chair Barrel Set

40 Ladder Barrel

41 Ped A Pull

42 Wall Tower

43 Wall Unit

43 Raised Mat

46 Upgrades & Options

48 Accessories

50 Dimensions & Features

52 Materials

53 Recyclable Packaging & Safe Shipping

For Professionals By Professionals

BASI Pilates is a leading education academy that brings thirty years of Pilates teaching experience to the design of our equipment. We work with Pilates professionals all over the world who strive for strength, athleticism, rehabilitation and the joy of healthy movement. After years of research and development, we introduce BASI Systems equipment as a dynamic vehicle for the Pilates community.

The equipment is designed by BASI founder, Rael Isacowitz, the internationally respected Pilates teacher, author, lecturer and creator of Pilates repertoire and apparatus. BASI Systems equipment incorporates scores of details Pilates professionals want, accessibility we need, innovations beyond what we could have imagined.



Finely Crafted Pilates Equipment

BASI Systems uses the highest quality, environmentally friendly and sustainable materials to build equipment with biomechanical and aesthetic integrity. Each piece is hand crafted with care and state-of-the-art engineering methodologies. We use beech wood for sturdiness, aerospace-grade aluminum for durability and smooth transitions, antibacterial vinyl that resists wear-and-tear and orthopedic cushioning for extraordinary comfort. BASI Systems equipment offers longevity with ergonomic functionality and an expandable design system that can seamlessly fit your needs.

"I approach the equipment like a dance partner; there is a give and take, an ebb and flow of energy, a sense of being supported and supporting at the same time. BASI Systems strikes a perfect balance of form and function and this makes the equipment feel alive in my hands."

Rael Isacowitz

inspiration
creativity
craftsmanship



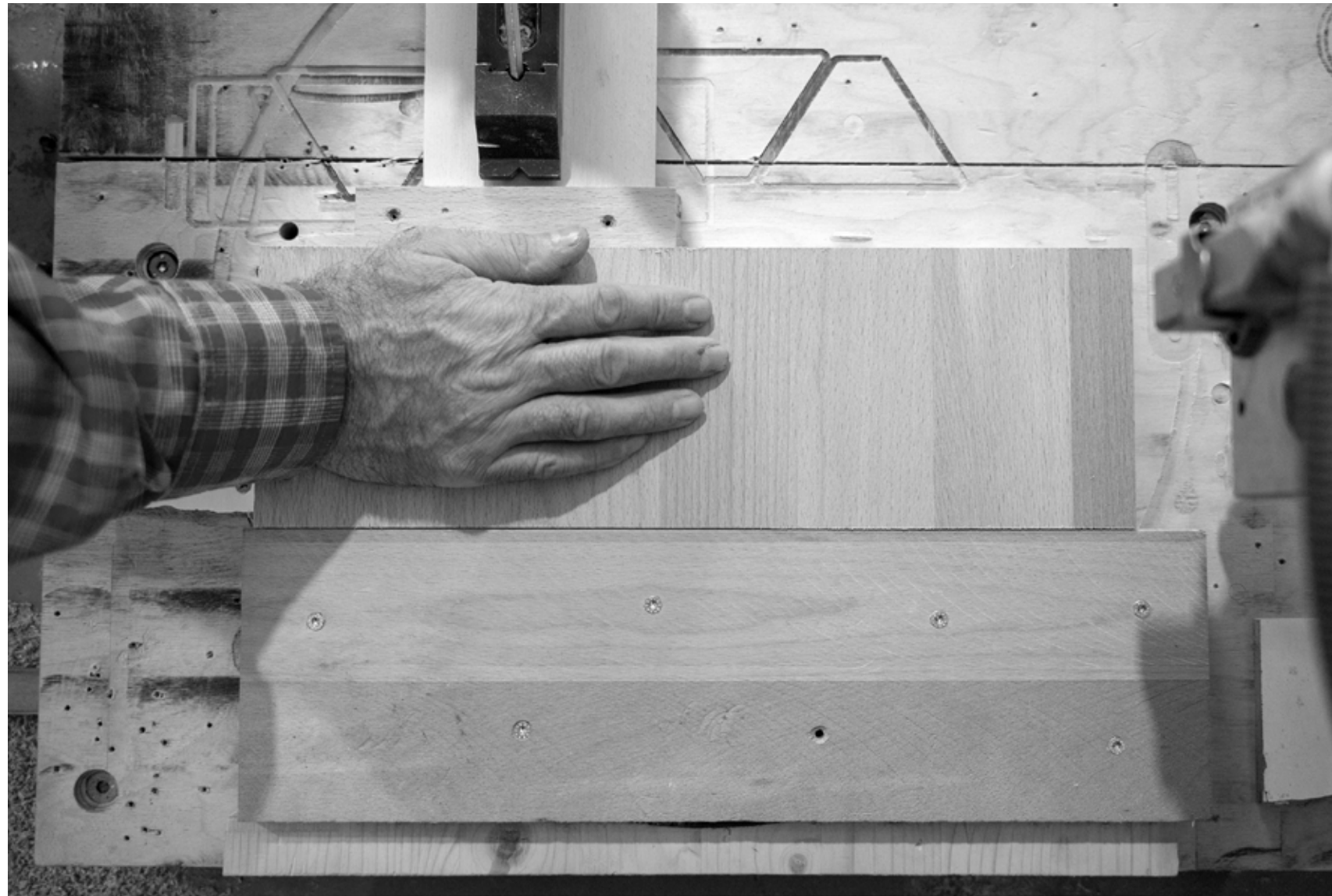

Research & Development

BASI Systems brings together decades of research of the art and science of human movement and state-of-the-art engineering. As a leading Pilates education academy, we have had the privilege to work with tens of thousands of Pilates professionals worldwide. In these interactions, we continuously learn more of what the human body needs and is capable of.

BASI Systems brings these insights to life with a new generation of equipment that unleashes true freedom of movement with unparalleled precision, comfort and accessibility. We do this by using world-class advances in technology while honoring the teachings of Joseph Pilates. We see BASI Systems equipment as an extension of ourselves - as movers and teachers - and our equipment is designed to inspire the discovery of one's true strength.



we have
our
obsession

DESIGNING
THE
ULTIMATE
PILATES
EQUIPMENT

Reformer

The BASI Systems Reformer is smooth in movement with powerful adjustability. Its innovative Enhanced Pulley System (EPS) provides fine-tuning control of the pulley angle and the expanded gear system allows precision in spring resistance settings. With the largest carriage cushion and the longest track in the industry, it offers unprecedented comfort and range of motion. It comes with four prepared ports to accommodate the revolutionary F2 System upgrade. The BASI Systems Reformer is an expandable system that seamlessly adapts to your needs.



Features

NEW! Additional to our standard Reformer, a new shorter Reformer model is also available (See page 50)

Aircraft quality aluminum tracks for smooth, quiet carriage ride

The longest and widest carriage in the industry

Orthopedic padded cushion extends the full width of the frame

Pulleys can be set anywhere along the height and width of the half tower

Highly adjustable headrest, shoulder rests and footbar

Three separate gear options for each of five springs

Easy conversion to a Reformer with Tower or Reformer Combo

Three extension leg height options available to suit your studio space

Equipped with four ports to accommodate the F2 System upgrade



Details



01 Jump board's orthopedic padded cushioning makes jumping gentle on hips, knees and ankles. The sitting box expands the repertoire of your BASI Systems Reformer. 02 Five footbar angle options: 23, 40, 60, 75 or 90 degrees. 03 Our unique Enhanced Pulley System offers fine tuning control of vertical and horizontal angles of pulleys and ropes. 04 Headrest, shoulder rests and carriage are covered in orthopedic cushioning and anti-bacterial vinyl. Headrest has three position settings. 05 Extension legs offer height options to best suit your studio space and teaching style. 06 Carriage with greater surface space and smoother glide. Six different position for each shoulder rest, forward, side or rear facing. 07 Three gear options for each spring for fine resistance combinations. 08 Footbar is covered with an easy-grip surface. 09 Equipped with silicon wheels for quick & easy mobility.

A New
Generation of
Equipment that
Unleashes True
Freedom of
Movement
with Unparalleled
Precision,
Comfort and
Accessibility



Reformer with Tower

BASI Systems Reformer with Tower is smooth in movement with powerful adjustability. Its innovative Enhanced Pulley System (EPS) gives fine-tuning control of the pulley angle and the expanded gear system allows precision in spring resistance settings. The Tower expands reformer and tower functionality with a myriad of spring setting options for straps, push-through and roll down bars. With the largest carriage cushion and the longest track in the industry, it offers unprecedented comfort and range of motion. It comes with four ports to accommodate the revolutionary F2 System upgrade. The BASI Systems Reformer with Tower is an expandable system that seamlessly adapts to your needs.



Features

- NEW!** Additional to our standard Reformer with Tower, a new shorter model is also available (See page 50)
- Can be used as a Reformer, Reformer with Tower and Raised Mat
- Easy conversion to a Reformer or Reformer Combo
- Aircraft quality aluminum tracks for a smooth, quiet carriage ride and push-through bar movement
- The longest and widest carriage in the industry
- Orthopedic padded cushion extends the full width of the frame
- Enhanced Pulley System gives the tower an unprecedented precision in spring setting options Pulleys can be set along the height and width of the tower frame
- Highly adjustable headrest, shoulder rests and footbar
- Three separate gear options for each of five springs
- Three extension leg height options available to suit your studio space
- Equipped with four ports to accommodate the F2 System

Details

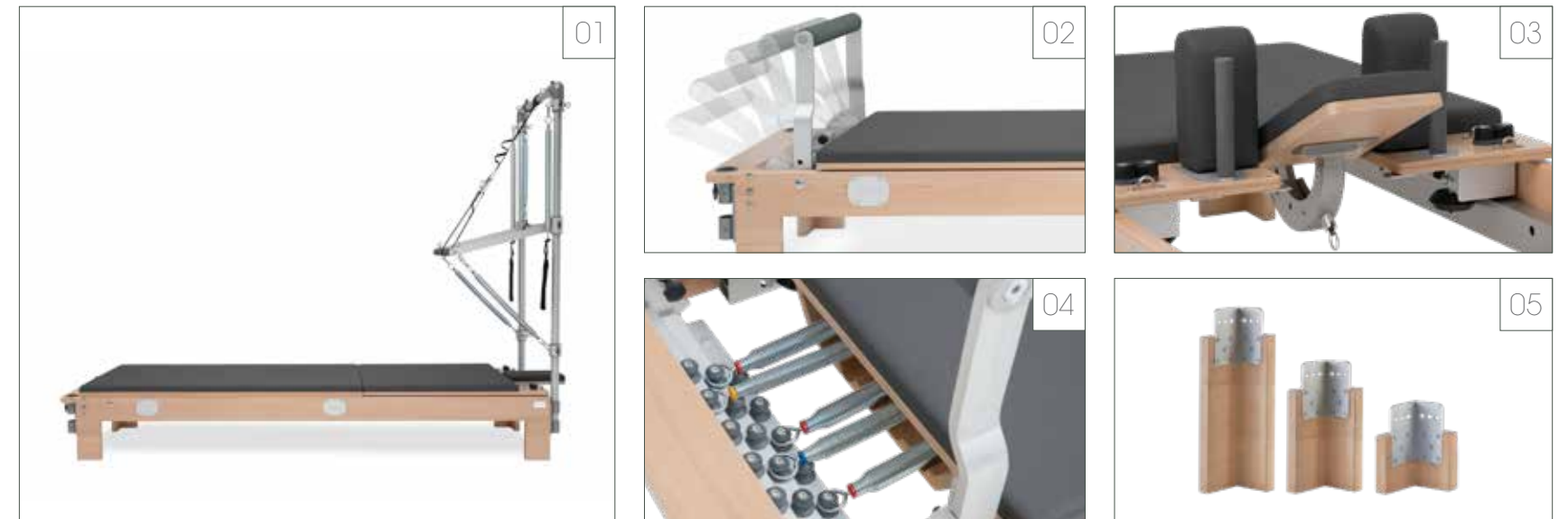

01 With the additional Mat Conversion your equipment can be used as a Reformer with Tower and Raised Mat. 02 Five footbar angle options: 23, 40, 60, 75 or 90 degrees. 03 Headrest, shoulder rests and carriage are covered in orthopedic cushioning and anti-bacterial vinyl. Headrest has three position settings. 04 Three gear options for each spring for fine resistance combinations. 05 Extension legs offer height options to best suit your studio space and teaching style. Equipped with silicon wheels for quick & easy mobility.

Reformer Combo

The BASI Systems Reformer Combo is smooth in movement with powerful adjustability in a space-saving design. Use it as a Reformer with the innovative Enhanced Pulley System (EPS) for fine-tuning control of the pulley angle and expanded gear system for precision in spring resistance settings. With the largest carriage cushion and the longest track in the industry, it offers unprecedented comfort and range of motion. Use it as a Reformer, Reformer with Tower or convert it to a Cadillac for full trapeze functionality and ultimate flexibility in spring positioning. The Reformer Combo comes with four prepared ports to easily accommodate the F2 System upgrade.



Features

- Can be used as a Reformer, Reformer with Tower, Cadillac and Raised Mat
- Aircraft quality aluminum tracks for a smooth, quiet carriage ride and push-through bar movement
- The longest and widest carriage in the industry
- Orthopedic padded cushion extends the full width of the frame
- Enhanced Pulley System gives the tower an unprecedented precision in spring setting options
- Pulleys can be set along the height and width of the tower frame
- Three separate gear options for each of five springs
- Three extension leg height options available to suit your studio space
- Highly adjustable headrest, shoulder rests and footbar
- Equipped with four ports to accommodate the F2 System

Details

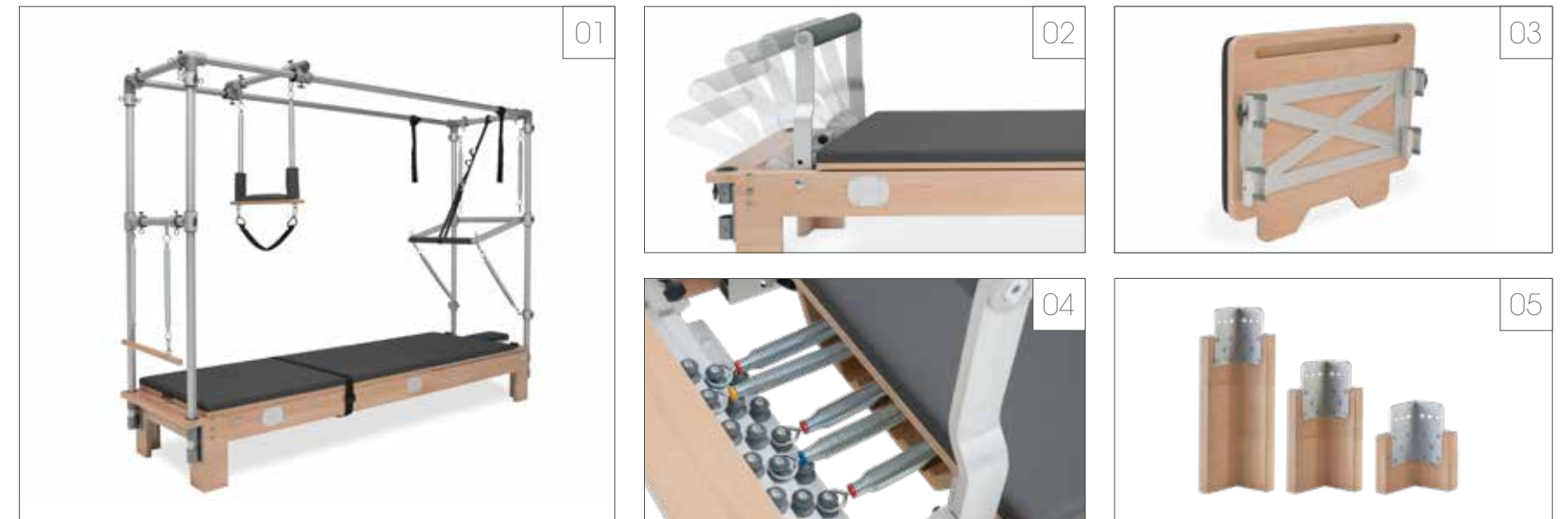

01 Reformer Combo has full features of BASI Systems Cadillac Trapeze table with addition of mat conversion. 02 Five footbar angle options: 23, 40, 60, 75 or 90 degrees. 03 Jump board's orthopedic padded cushioning makes jumping gentle on hips, knees and ankles. 04 Three gear options for each spring for five resistance combinations. 05 Extension legs offer height options to best suit your space and teaching style. Equipped with silicon wheels for quick & easy mobility.

Effortless Movement
Infinite Adjustability



Trapeze Table - Cadillac

The BASI Systems Cadillac provides unprecedented adjustability. With the largest mat in the industry and fine-tuning control of spring positioning (EPS), it offers ultimate precision, flexibility and comfort. The Cadillac comes with four prepared ports to easily accommodate the F2 System upgrade.



Features

- Aircraft quality aluminum for smooth, quiet push-through bar and trapeze movement and spring setting
- Premium comfort with orthopedic cushioning and non-slip antibacterial vinyl
- Padded easy-grip covering on push-through bar and trapeze swing
- The longest and the widest mat table in the industry
- Highly adjustable and precise spring placement options
- Three extension leg height options available to suit your studio space
- Equipped with four ports to accommodate the F2 System

Details



- 01 With the largest carriage cushion and the longest track in the industry, Trapeze table offers unprecedented comfort and range of motion. 02 Removable headrest supported with orthopedic cushioning. 03 Trapeze functionality includes Push Through Bar, Roll Down Bar and Enhanced Pulley System (EPS) for ultimate flexibility in Trapeze spring placement. 04 Equipped with silicon wheels for quick & easy mobility. 05 Extension legs offer height options to best suit your studio space and teaching style.

BASI Systems Equipment gives you real smart choices with a variety of options from interchangeable parts to revolutionary F2 System.

smarter
equipment
smarter
studio

Interchangeable Tower Systems

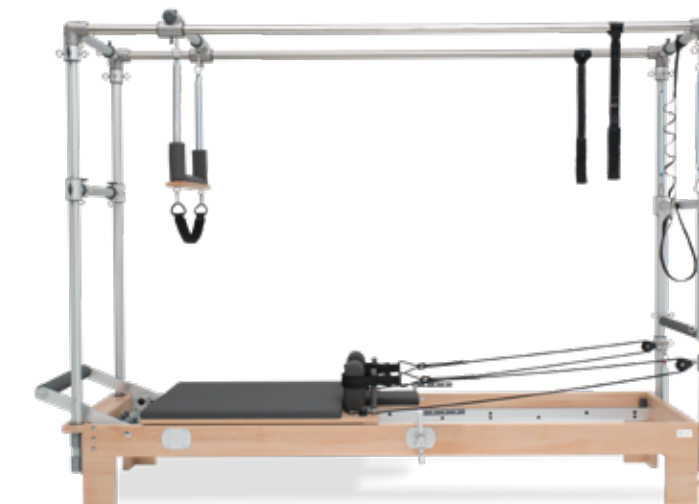
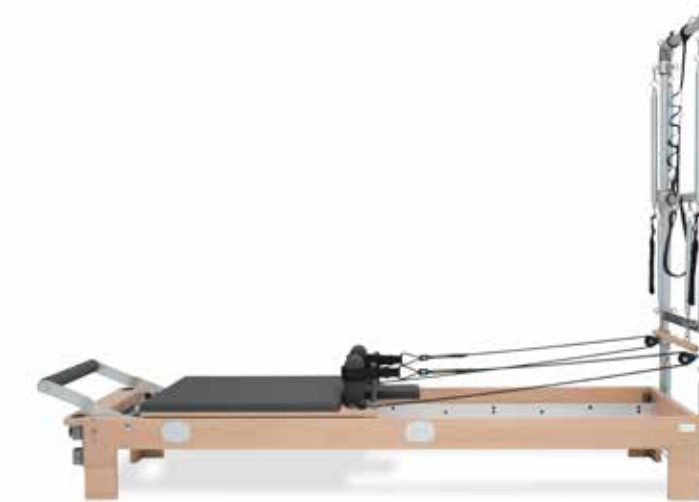

Your BASI Systems Equipment is part of an expandable system. You can convert your **Reformer** to a **Reformer Tower** or a **Reformer Combo** to suit your studio space and teaching style.

Enhanced Pulley System (EPS)

BASI Systems unique Enhanced Pulley System (EPS) gives you unparalleled freedom to set the accessibility and resistance levels of Reformer and Tower pulleys. Using marked poles, pulley height and angle can be quickly set with fine-tuned precision so the perfect set-up today can be replicated tomorrow and progress is easily monitored.

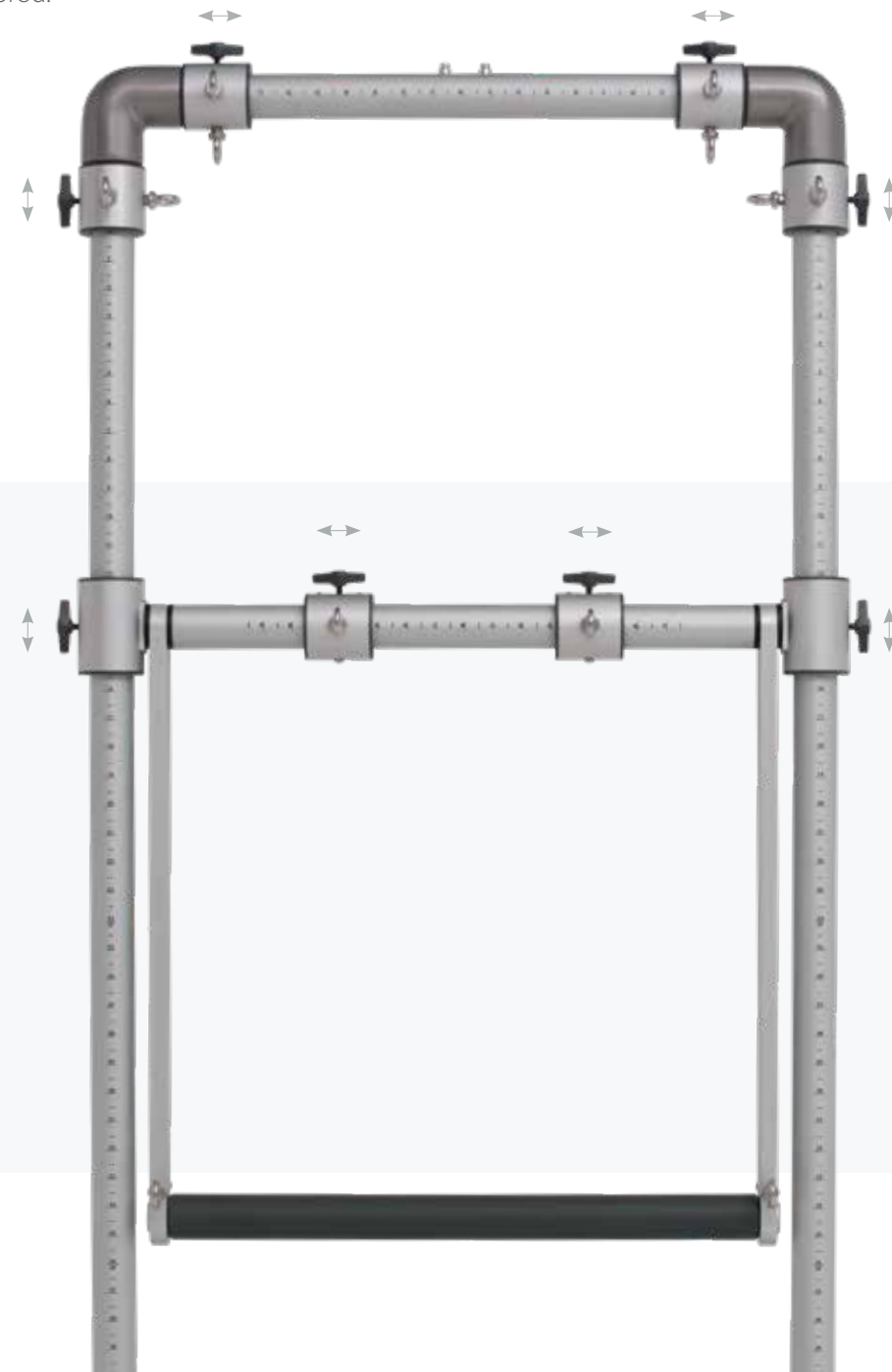

F2 System

The F2 System lies at the heart of BASI Systems Pilates equipment. A true innovation for Pilates movement, it offers unprecedented versatility and precision in spring angle and resistance settings. Springs can be attached to multiple ports on your Reformers, Cadillac, Barrels, Chairs and Spine Corrector. Multiple F2 Systems can be used simultaneously to inspire exciting new repertoire possibilities. The levers also serve as handles to support wrists and shoulders in optimal position for weight bearing exercises. Your BASI Systems equipment is shipped with prepared ports to accommodate a seamless upgrade to the F2 System. Simply remove the port cover, insert the F2 socket, and you are ready to explore a new precision and flow of Pilates movement.

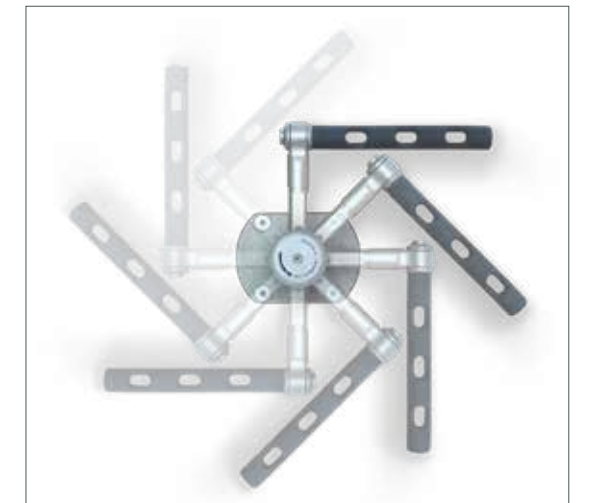

Wunda Chair



The BASI Systems Wunda Chair has an innovative pedal design that extends mobility, offers smooth transitions and fine-tuning adjustability of spring tension and handle height. Your BASI Systems Wunda Chair comes with prepared ports to seamlessly accommodate the revolutionary F2 System upgrade.

Features

Smooth transitions between resistance settings without removal of springs

Rounded ergonomic split pedal offers comfort as well as consistent and broad range of motion

Seat, handle grips and pedals are covered with antibacterial, easy grip, orthopedic cushioning

Removable handles have four locking positions every 6.5 centimeters, 2.56 inches

Prepared ports support the F2 System upgrade, adding a finely adjustable spring system to chair work



Details

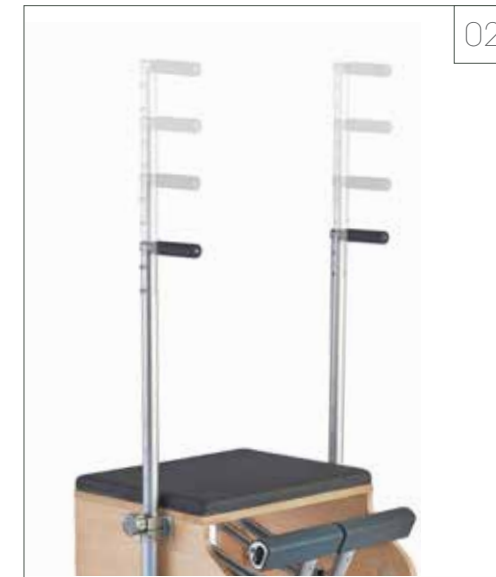

01 Higher pedal position offers greater mobility options. 02 Non-slip padded handles are adjustable to four levels. 03 Spring resistance can be changed easily without removing springs. 04 Equipped with silicon wheels for quick & easy mobility. 05 BASI Systems Revolutionary F2 System adds versatility and unparalleled precision in settings of spring angle and degree of resistance.



Spine Corrector

BASI Systems Spine Corrector has orthopedic padded cushioning and easy-grip padded handles. Its curved bottom design makes it easier to lift and reposition. The BASI Systems Spine Corrector is designed to take advantage of the F2 System add-on, which brings leading-edge functionality to barrel work. With the innovative F2 System, springs can be attached at a multitude of angles and resistance levels for expansive and innovative repertoire.



Features

NEW! Additional to our standard Spine Corrector, a new deeper curve model is also available (See page 51)
Ergonomic design and orthopedic padded cushioning supports optimal positioning and movement
Prepared ports support the F2 System upgrade, adding a highly versatile spring system to spine corrector work
F2 System levers serve as handles to place wrists and shoulders in optimal position for weight bearing exercises

Details



01 The standart curve. 02 New deeper curve. 03 Prepared ports can be used with rubber handles, F2 System or without handles at all.

Arm Chair Barrel Set

BASI Systems Arm Chair Barrel Set brings leading edge functionality to barrel work. The orthopedic padded cushion top has a curved design. The saddle flat-top accessory gives you the option to interchangeably select the most comfortable and stable surface for each exercise. With the F2 System, springs can be attached at a multitude of angles and resistance levels for expansive and innovative barrel repertoire. Use it with the Ladder and Arm Chair Box for additional F2 System options.



Features

- The longest track in the industry offers new movement possibilities
- Premium comfort with orthopedic cushioning and non-slip antibacterial vinyl
- Saddle accessory gives interchangeable curved and flat-top options
- Platform moves out of the way when not in use
- Sturdy beech wood frame is hand crafted like fine furniture
- Prepared ports support the F2 System, adding a finely adjustable spring system to barrel work
- F2 System levers serve as handles to place wrists and shoulders in optimal position for weight bearing exercises

Details

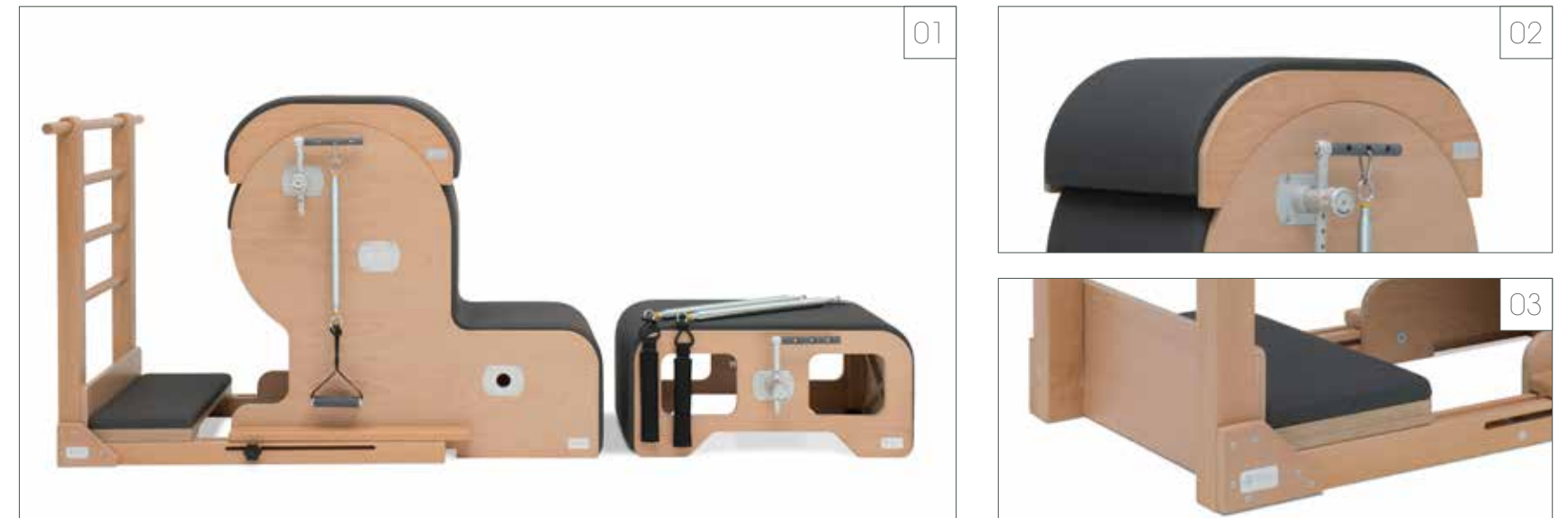

01 F2 System levers serve as handles to place wrists and shoulders in optimal position for weight bearing exercises. 02 Saddle accessory gives interchangeable curved and flat-top options. 03 The longest track in the industry offers new movement possibilities.

Ladder Barrel

BASI Systems Ladder Barrel brings leading edge functionality to barrel work. The orthopedic padded cushion is a curved design that adds comfort and support. The barrel is connected to the ladder with linear slides for smooth movement. Its expanded width and standing platform brings accessibility to barrel work. With its innovative F2 System upgrade, springs can be attached at a multitude of angles and resistance levels for expansive and innovative barrel repertoire.

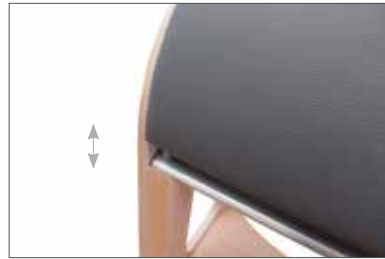

Hand controlled adjustability.



Features

NEW! Hand controlled adjustability

The longest track in the industry offers new movement possibilities

Smooth movement through linear slides

Premium comfort with orthopedic cushioning and non-slip antibacterial vinyl covering

Sturdy beech wood frame is hand crafted like fine furniture

Platform moves out of the way when not in use

Prepared ports support the F2 System upgrade, adding a highly versatile spring system to barrel work

F2 System levers serve as handles to place shoulders and wrists in optimal position for weight bearing exercises

Ped A Pull

BASI Systems Ped A Pull delivers powerful control in spring settings with variable height and width adjustability. Its base is ergonomically designed to accommodate sitting and standing work and the optional rotating seat expands accessibility and repertoire possibilities.



Features

Highly precise spring settings with variable height and width adjustability

Ergonomic design accommodates seated and standing work

Optional seat expands accessibility and repertoire possibilities

Seat height is adjustable and it can rotate out of the way when not in use

Wall Tower

The BASI Systems Wall Tower delivers powerful adjustability in an affordable design. With fine-tuning control of spring positioning, the largest mat in the industry, roll-down and smooth push through functionality, BASI Systems Wall Tower offers ultimate comfort and flexibility.



Features

- Fine-tuning control of spring angle and positioning
- Aircraft quality aluminum tracks for smooth adjustability of spring holders and push-through bar technology
- Orthopedic cushioning and antibacterial vinyl on the mat
- Sturdy beech wood frame
- Easy grip padded handles

Wall Unit

The BASI Systems Wall Unit delivers powerful tower functionality and adjustability in a space-saving design. With fine-tuning control of spring positioning, roll-down and smooth push through functionality, BASI Systems Wall Unit offers affordable flexibility.

Features

- Fine-tuning control of spring angle and positioning
- Aircraft quality aluminum tracks for smooth adjustability of spring holders and push-through bar technology
- Sturdy beech wood frame
- Enhanced Pulley System gives Wall Unit an unprecedented precision in spring setting options
- Also available without the Push-through-bar



Raised Mat

The BASI Systems Raised Mat features orthopedic cushioning and easy grip handles. It is designed to add different levels to your mat work. Can be used with small, medium or tall extension legs to suit your teaching style.





CHOOSE

COMFORT

FLEXIBILITY

PRECISION

MOVEMENT

FREEDOM

DURABILITY

UPGRADES & OPTIONS

Sitting Box

BASI Systems Sitting Box expands the repertoire of your BASI Systems Reformer. Its orthopedic padded cushioning brings comfort to a range of seated, supine and prone exercises.

Arm Chair Saddle

The Saddle provides a flat surface for your Arm Chair Barrel. Simply place it on top of the Barrel's arc to support comfortable and secure movement possibilities.

Arc

BASI Systems Arc expands the repertoire, brings comfort and supports your exercises.

Mat Conversion

The Mat Conversion expands your BASI Systems Reformer, giving you space for mat work. (The Mat Conversion is already included with your BASI Systems Reformer with Tower and Reformer Combo).

Jump Board for Reformer

BASI Systems Jump Board brings a strengthening cardio experience to your BASI Systems **Reformer** and **Reformer with Tower** repertoire. Its orthopedic padded cushioning makes jumping gentler to hips, knees and ankles.

Jump Board for Reformer Combo

BASI Systems Jump Board brings a strengthening cardio experience to your BASI Systems **Reformer Combo** repertoire. Its orthopedic padded cushioning makes jumping gentler to hips, knees and ankles.



Extension Leg Set



F2 System



The Extension Leg Set offers the height option to best suit your space and teaching style. They are suitable for your **Reformer**, **Reformer with Tower**, **Reformer Combo**, **Cadillac** and **Raised Mat**.

Tall

The Tall Leg Set will raise the height of your equipment to 15.4 inches, 39 centimeters.

Medium

The Medium Leg Set can be used to lower your Cadillac from its standard height or raise the **Reformer**, **Reformer with Tower** or **Reformer Combo**.

Short

The Medium Leg Set is 7.6 inches, 19.5 centimeters. It can be used to lower your Cadillac from its standard height or raise the height of your **Reformer**, **Reformer with Tower** or **Reformer Combo**.

Please see page 51 for dimensions.

The F2 System lies at the heart of BASI Systems Pilates equipment. A true innovation for Pilates movement, it offers unprecedented versatility and precision in spring angle and resistance settings. Springs can be attached to multiple ports on your **Reformer**, **Cadillac**, **Barrels**, **Chair** and **Spine Corrector**. Multiple F2 Systems can be used simultaneously to inspire exciting new repertoire possibilities.

F2 System Accessory Package

Full accessory package includes Yellow Springs (2), Carabiners (2), Neoprene Handles (2). Pieces are also available separately.

Connectors

The F2 System connector replaces the BASI cover that is shipped with your equipment. Simply attach the connector to the prepared port on your equipment, attach the F2 System lever, and you are ready to experience this innovation for Pilates movement.

(F2 System Connectors are already included in Arm Chair Barrels.)

ACCESSORIES

Ankle Strap

BASI Systems Neoprene Ankle Straps are padded and covered with soft fleece. They have non-metallic attachments for quiet use.



Aluminum Handles

The light weight BASI Systems Aluminum Handles have a soft antibacterial covering for a firm grip and non-metallic attachments for quiet use.



Ropes

Durable and soft, BASI Systems Ropes are made with non-stretch materials and come with non-metallic hyphen attachments for quiet use. 114.5" (291 cm.)



Foot Platform

Wooden platform for leveling the Reformer carriage with the foot platform.



Cushion Block

BASI Systems Cushion Block can be used with variety of BASI Systems equipment for comfort.

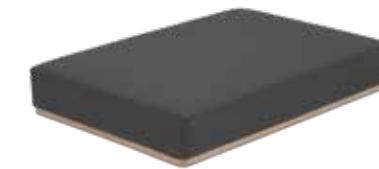

Wood Pole

Hardwood pole for balance exercises. 63" (160 cm.)



Foot Strap

BASI Systems Foot Strap is padded and covered with soft fleece.



Fuzzy

BASI Systems Fuzzies are padded and covered with soft fleece.



Safety Strap

BASI Systems Safety Strap secures the push through bar when it is used in the bottom-loaded position.



Mat

BASI Systems Pilates Mat offers strong support for your exercises. The non slip rubber foam material is Phthalate free, has minimum stretch and is very light in weight. (70.9" x 23.6" x 0.39" - 180 cm. x 60 cm. x 1 cm.)



Leg Strap

BASI Systems Leg Strap has an easy-to-use buckle for quick adjustments.



Neoprene Handles

BASI Systems Neoprene Handles are padded and covered with soft fleece. They have non-metallic attachments for quiet use.



Y-Loops

BASI Systems Neoprene Y-loop strap are padded and covered with soft fleece. They have non-metallic attachments for quite use.



Equipment Upholstery Color Chart

Choose from 8 standard vinyl colors or create your own.



01 Anthracite Grey



02 Dark Cool Sand



03 Campfire Orange



04 Burgundy



05 Moonless Night Black



06 Pristine White



07 Dark Navy



08 Petrol Green

DIMENSIONS & FEATURES



INCLUDED Half Tower, Extension Leg Set (short), Foot Platform, Shoulder Rests (2), Rubber Handles (2), Pulleys (2), Ropes (2), Neoprene Handles (2), Foot Strap, Aluminum Handles (2), Stoppers (4) - **Springs** Yellow (1), Blue (1), Red (3)
DIMENSIONS - wooden frame width 27.6" (70 cm.) / length 98.4" (250 cm.) / height 7.9" (20 cm.) - **with half tower** width 28.4" (72 cm.) / length 100" (254 cm.) / height 34.3" (87 cm.) - **carriage** width 27.6" (70 cm.) / length 31" (79 cm.) / height 2.36" (6 cm.) - **with extension leg (short)** height 39" (99.5 cm.)
NEW! Reformer Small - wooden frame width 27.6" (70 cm.) / length 90.6" (230 cm.) / height 7.9" (20 cm.) - **with extension leg (short)** height 39" (99.5 cm.)
WEIGHT 196 lb (89 kg.) - **Reformer Small** 187 lb (85 kg.)
OPTIONS Sitting Box, Jump Board, Mat Conversion, Extension Leg Set (medium/tall)
UPGRADES F2 System with Accessory Package, Tower for Reformer with Tower conversion, Trapeze for Reformer Combo conversion, Mat Conversion



INCLUDED Trapeze, Mat Conversion, Extension Leg Set (short), Foot Platform, Shoulder Rests (2), Rubber Handles (2), Pulleys (2), Ropes (2), Foot Strap, Neo-prene Handles (4), Aluminum Handles (2), Safety Strap, Leg Strap, Roll Down Bar, Push-through Bar, Stoppers (4), **Springs For Reformer** Yellow (1), Blue (1), Red (3), **Springs For Tower** Yellow (2), Long Yellow (2), Blue (2), Red (2), Carabiners (14)
DIMENSIONS - wooden frame width 27.6" (70 cm.) / length 98.4" (250 cm.) / height 7.9" (20 cm.) - **with tower** width 28.4" (72 cm.) / length 100" (254 cm.) / height 70.9" (180 cm.) - **carriage** width 27.6" (70 cm.) / length 31" (79 cm.) / height 2.36" (6 cm.) - **mat conversion** width 27.5" (70 cm.) / length 57" (145.5 cm.) / height 2.36" (6 cm.) - **with extension leg (short)** height 76.5" (194.5 cm.)
NEW! Reformer with Tower Small - wooden frame width 27.6" (70 cm.) / length 90.6" (230 cm.) / height 7.9" (20 cm.) - **with extension leg (short)** height 76.5" (194.5 cm.)
WEIGHT 223.7 lb (101.5 kg.) - **Reformer with Tower Small** 215 lb (97.5 kg.)
OPTIONS Sitting Box, Jump Board, Extension Leg Set (medium/tall)
UPGRADES F2 System with Accessory Package, Half Tower for Reformer conversion, Trapeze for Reformer Combo conversion



INCLUDED Trapeze, Mat Conversion, Extension Leg Set (short), Foot Platform, Shoulder Rests (2), Rubber Handles (2), Pulleys (2), Ropes (2), Foot Straps (2), Fuzzies (2), Neoprene Handles (4), Aluminum Handles (2), Safety Strap, Leg Straps (2), Roll Down Bar, Push-through Bar, Stoppers (4), **Springs For Reformer** Yellow (1), Blue (1), Red (3), **Springs For Trapeze** Yellow (2), Long Yellow (2), Blue (2), Red (2), Black (2), Purple (2), Carabiners (20)
DIMENSIONS - wooden frame width 27.6" (70 cm.) / length 98.4" (250 cm.) / height 7.9" (20 cm.) - **with trapeze** width 28.4" (72 cm.) / length 100" (254 cm.) / height 71.7" (182 cm.) - **carriage** width 27.6" (70 cm.) / length 31" (79 cm.) / height 2.36" (6 cm.) - **mat conversion** width 27.5" (70 cm.) / length 57" (145.5 cm.) / height 2.36" (6 cm.) - **with extension leg (short)** height 77.4" (196.5 cm.)
WEIGHT 380 lb (172.5 kg.)
OPTIONS Sitting Box, Jump Board for Combo, Extension Leg Set (medium/tall)
UPGRADES F2 System with Accessory Package, Half Tower for Reformer conversion, Tower for Reformer with Tower conversion



INCLUDED Trapeze, Extension Leg Set (Tall), Foot Strap, Neoprene Handles (2), Aluminum Handles (2), Fuzzies (2), Safety Strap, Leg Strap, Roll Down Bar, Swing, Push-through Bar **Springs For Trapeze** Yellow (2), Long Yellow (2), Blue (2), Red (2), Black (2), Purple (2), Carabiners (20)
DIMENSIONS - wooden frame with trapeze table width 27.6" (70 cm.) / length 98.4" (250 cm.) / height 10.24" (26 cm.) - **with trapeze** width 28.4" (72 cm.) / length 100" (254 cm.) / height 71.7" (182 cm.) - **with extension leg (tall)** height 87" (221 cm.)
WEIGHT 331 lb (150.5 kg.)
OPTIONS Sitting Box, Extension Leg Set (medium/short)
UPGRADES F2 System with Accessory Package

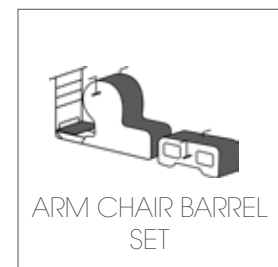

INCLUDED Arm Chair Box, Ladder (with Platform), F2 System (for Arm Chair Barrel), F2 System (for Arm Chair Box), Neoprene Handles (2), Aluminum Handles (2) **Springs** Yellow (2), Long Yellow (2)
DIMENSIONS - barrel width 23" (58.5 cm.) / length 40" (103.5 cm.) / height 37.5" (95 cm.) - **ladder** width 36" (91.5 cm.) / length 42" (105.5 cm.) / height 37.5" (95 cm.)
arm chair box width 18" (46 cm.) / length 31" (80 cm.) / height 14" (37 cm.)
WEIGHT barrel 79 lb (36 kg.) - **ladder** 40 lb (18 kg.) - **arm chair box** 37 lb (17 kg.)
OPTIONS Saddle

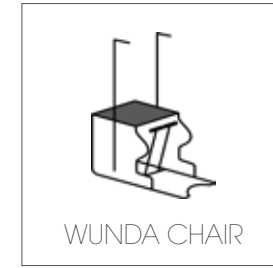

INCLUDED Arms (2) **Springs** Yellow (2), Black (2)
DIMENSIONS wooden frame width 28.7" (73 cm.) / length 35.5" (90 cm.) / height 24.5" (62 cm.) - **with handles** minimum height 46" (117.5 cm.) / maximum height 55.5" (141 cm.)
padded surface of the seat width 21.7" (55 cm.) / length 17" (43 cm.) / height 2.36" (6 cm.)
WEIGHT 52 lb (23.5 kg.)
UPGRADES F2 System with Accessory Package



INCLUDED Safety Strap, Foot Strap, Leg Strap, Rubber Handles (2), Roll Down Bar, Neoprene Handles (2), Aluminum Handles (2), Push-through Bar, **Springs For Tower** Yellow (2), Long Yellow (2), Blue (2), Red (2)
DIMENSIONS - wooden frame width 27.6" (73 cm.) / length 98.4" (250 cm.) / height 6.3" (16 cm.) - **with tower** height 76" (194 cm.) - **padded surface** width 27.6" (70 cm.) / length 95.5" (243 cm.) / height 2.36" (6 cm.) / **WEIGHT** 217 lb (101.5 kg.)

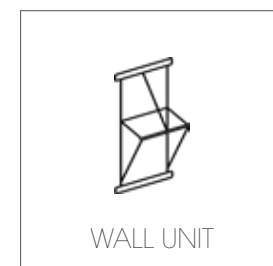

INCLUDED Neoprene Handles (2), Aluminum Handles (2), Safety Strap, Roll Down Bar, Push-through Bar **Springs** Yellow (2), Long Yellow (2), Red (2), Blue (2)
DIMENSIONS width 15.5" (40 cm.) / length 39" (100 cm.) / height 15" (37.5 cm.) / **WEIGHT** 37 lb (17 kg.)



DIMENSIONS wooden frame width 27.6" (73 cm.) / length 98.4" (250 cm.) / height 6.3" (16 cm.) / **WEIGHT** 176 lb (80 kg.)



DIMENSIONS width 27.5" (70 cm.) / length 57" (145.5 cm.) / / height 2.36" (6 cm.) / **WEIGHT** 30 lb (13.5 kg.)

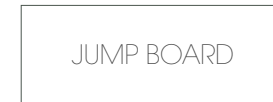

DIMENSIONS Reformer width 27.6" (73 cm.) / height 6.3" (16 cm.) / **WEIGHT** 24 lb (11 kg.)
Reformer Combo width 27.6" (73 cm.) / height 6.3" (16 cm.) / **WEIGHT** 22 lb (10 kg.)



DIMENSIONS width 15.7" (40 cm.) / length 30" (76 cm.) / height 12.2" (31 cm.) / **WEIGHT** 13 lb (6 kg.)



DIMENSIONS
Short Set height 4.9" (12.5 cm.) / **WEIGHT** 10 lb (4.5 kg.)
Medium Set height 7.6" (19.3 cm.) / **WEIGHT** 11 lb (5 kg.)
Tall Set height 15.3" (38.8 cm.) / **WEIGHT** 21 lb (9.5 kg.)

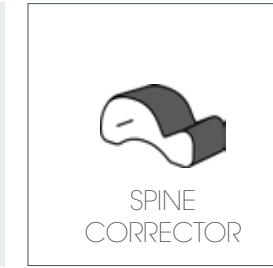

INCLUDED Rubber Handles (2)
DIMENSIONS width 15.8" (40 cm.) / length 38.6" (98 cm.) / height 14.6" (37 cm.) / **WEIGHT** 28" (12.5 kg.)
NEW! Spine Corrector Deep Curve width 15" (37 cm.) / length 33.8" (86 cm.) / height 13.4" (34 cm.) / **WEIGHT** 23.5 lb (11.5 kg.)
UPGRADES F2 System with Accessory Package

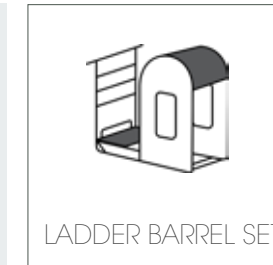

INCLUDED Standing Platform
DIMENSIONS ladder width 36" (91.5 cm.) / length 42" (105.5 cm.) / height 37.5" (95 cm.) - **barrel** width 24.5" (62 cm.) / length 21.7" (55 cm.) / height 37.5" (95 cm.) / **WEIGHT** 49 lb (22 kg.)
UPGRADES F2 System with Accessory Package

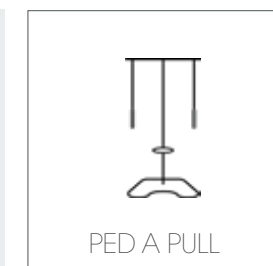

INCLUDED Neoprene Handles (2), Wooden Seat
Springs Yellow (2)
DIMENSIONS width 25.6" (65 cm.) / length 24" (61 cm.) / maximum height 61.8" (157 cm.) / minimum height 109" (277 cm.)
stool (seat diameter) 9.8" (25 cm.)
WEIGHT with stool 31 lb (14 kg.)



DIMENSIONS width 18.3" (46.5 cm.) / length 27.5" (65 cm.) / height 9.4" (24 cm.) / **WEIGHT** 14 lb (6.5 kg.)



DIMENSIONS width 11" (28 cm.) / length 23" (58 cm.) / height 2.5" (6.5 cm.) / **WEIGHT** 6.6 lb (3 kg.)



DIMENSIONS width 6" (15 cm.) / length 20.5" (52 cm.) / height 3.5" (9 cm.) / **WEIGHT** 4.4 lb (2 kg.)



DIMENSIONS width 21.9" (55.5 cm.) / length 20.5" (52 cm.) / height 6.3" (16 cm.) / **WEIGHT** 11 lb (5 kg.)



DIMENSIONS width 21" (53 cm.) / length 14" (36 cm.) / height 3.5" (9 cm.) / **WEIGHT** 6 lb (3 kg.)

MATERIALS

BASI Systems uses the highest quality and sustainable materials to build equipment with biomechanical and aesthetic integrity. Beech wood is preferred for a sturdy, furniture-like finish and a strong support for metal structures applied on the wood frames.

A water based, hybrid varnish formula is prepared especially for BASI Systems in order to make the equipment safe both for the environment and for yourself. The water based varnish is applied and dried during manufacturing process and does not continue to release any toxic gasses after production.

BASI Systems vinyl is reach compliant; antibacterial, free from phthalates, heavy metals and azo dyes. Soft touch technology creates a unique combination of a soft luxurious feel and a matte finish.

Aerospace grade aluminum is preferred for durability and smooth transitions.

Our engineers and designers in BASI Systems Research & Development Center are always interested to hear your comments and ideas.



Fire Retardant



Phthalate Free



Reach Compliant

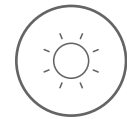

UV Stable



Anti Bacterial



Soft Touch



RECYCLABLE PACKAGING & SAFE SHIPPING

Eco-consciousness is part of our everyday manufacturing life.

Our packaging experts are developing new designs and keep researching for optimum sustainable packaging materials to make sure your products arrive safely and makes the smallest environmental impact.



GET IN TOUCH

For general inquiries
info@basisystems.com

For purchases & offers
equipment@basisystems.com

For the latest product news
basisystems.com

SOCIALIZE WITH US



