

LED Shoebox Light Instruction

Cautions:

1. Can not use the electric generator to test the LED lamp.
2. Please abide by related country, regional and local law and regulations when install this fixture.
3. To avoid electrical shock and damage, please do not install the lights in raining days.

Notices:

1. To prevent from electric shock or fire risk, the installation must be conducted by operator who have professional electrical knowledge.
2. Please wear gloves to avoid injury before installing lamps.
3. During or after installation, if there are situations such as smoke, fire in the wires or lamps, please turn off the power immediately and notify relevant personnel of an overhaul.
4. This light can be used for outdoor installation.

Instructions:

1. This product has dimming function.
2. 3 dimming functions are available in this shoebox light:
 - (1). Constant current can be achieved by 1-10VDC dimming.
 - (2). PWM signal dimming.
 - (3). Variation of resistance unit dimming (Please choose the appropriate dimming way according to your needs. You can also choose not to use this function).
3. Choose the wire connection ways, dimming ways and installation ways according to your needs and the led fixture purchased.

Wiring Diagram:

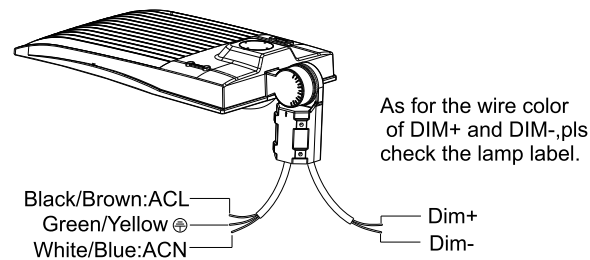

Optional Brackets and Installation Instructions

There are 4 optional brackets for this fixture. The following is shoebox fixtures with different brackets

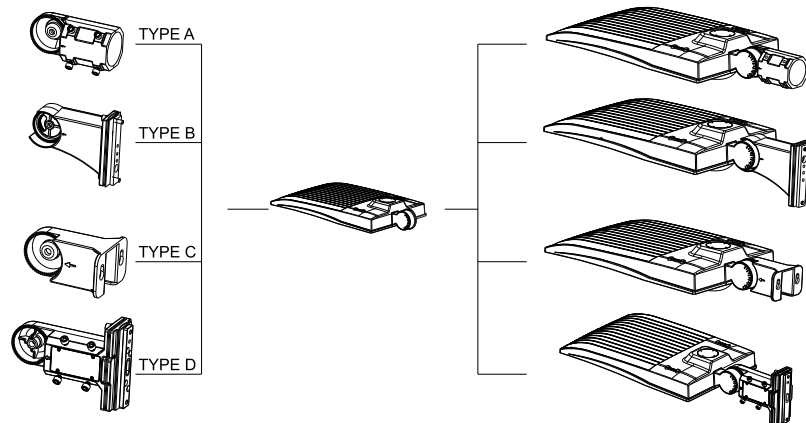

Installation Instructions with different brackets:

1. ADJUSTABLE FITTER MOUNTING (TYPE A)

Step 1: Remove the bracket mounting screws on the fixture and run the wires through the bracket. (Figure 1)

Step 2: Install the bracket on the fixture. (Figure 2)

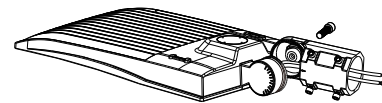

Figure 1

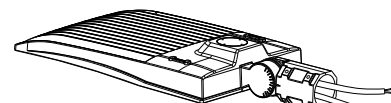

Figure 2

2. DIRECT MOUNTING (TYPE B)

Step 1: Remove the bracket mounting screws on the fixture, open the side lid of bracket and run the wires through the bracket. (Figure 3)

Step 2: Install the bracket on the fixture, then cover the side lid and tighten it. (Figure 4)

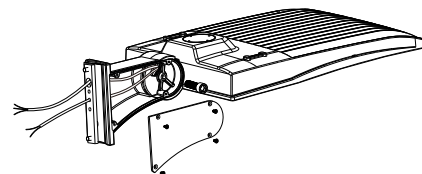

Figure 3

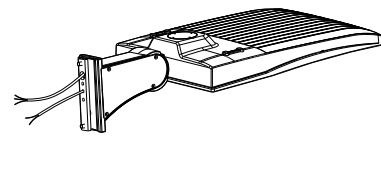

Figure 4

3. YOKE MOUNTING (TYPE C)

Step 1: Remove the bracket mounting screws on the fixture and run the wires through the bracket. (Figure 5)

Step 2: Install the bracket on the fixture. (Figure 6)

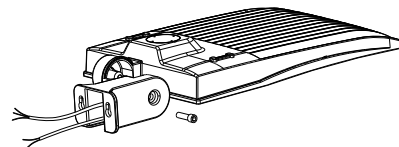

Figure 5

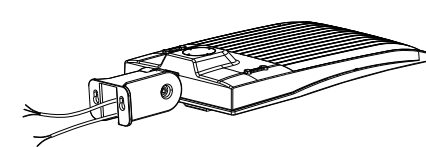

Figure 6

4. ADJUSTABLE FITTER MOUNTING & DIRECT MOUNTING (TYPE D)

Step 1: Remove the bracket mounting screws on the fixture, open the side lid of bracket and run the wires through the bracket. (Figure 7)

Step 2: Install the bracket on the fixture, then cover the side lid and tighten it. (Figure 8)

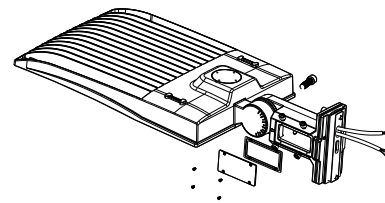

Figure 7

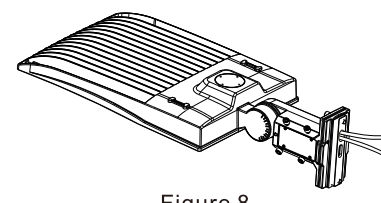

Figure 8

Installation of LED Lamps:

1. ADJUSTABLE FITTER MOUNTING (TYPE A)

Step 1: Loosen the four bolts on AM bracket, connect the wires correctly, and pull the wires into the poles. (Figure 9)

Step 2: Place the bracket into the pole and lock the four bolts. (Figure 10)

Notice: Adjustable angle is 0-90° (Figure 9)

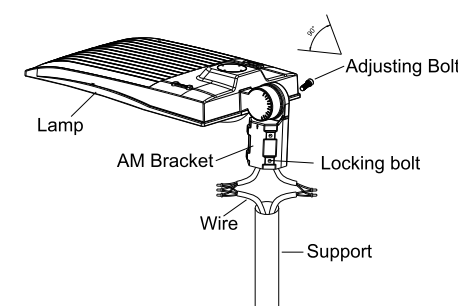

Figure 9

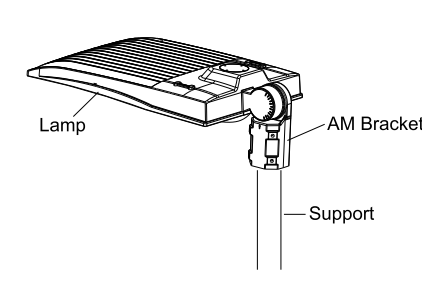

Figure 10

2. DIRECT MOUNTING (TYPE B)

Step 1: Fix DM bracket to square pole with bolt, open the side lid of DM bracket, pull the wire into junction box, and connect the wire correctly. (Figure 11)

Step 2: Put the connected wire into the junction box, then cover the junction box. (Figure 12)

Notice: Adjustable angle is 0-35° (Figure 11).

Same as round pole installation, please remember to remove the silicon plate when install the fixture in round pole (Figure 13)

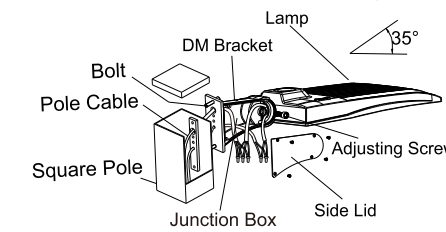

Figure 11

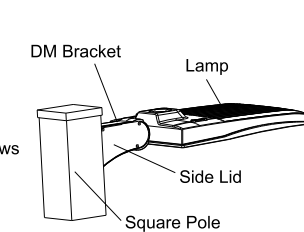

Figure 12

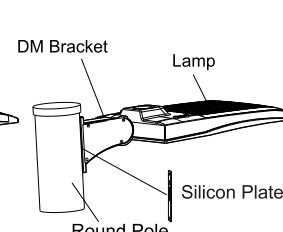

Figure 13

3. YOKE MOUNTING (TYPE C)

Step 1: Drill holes on the wall as shown. (Figure 14)

Step 2: Knock the expansion bolts into the wall. (Figure 15)

Step 3: Connect the fixture to the bracket and tighten the screws; connect the wires properly and put them into junction box. (Figure 16)

Notice: Adjustable angle is 0-90° (Figure 16)

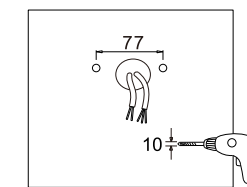

Figure 14

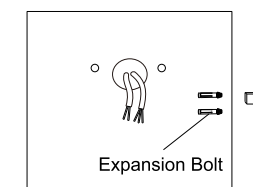

Figure 15

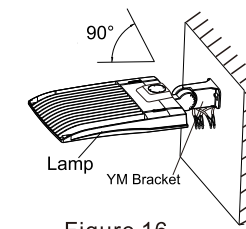

Figure 16

4. ADJUSTABLE FITTER MOUNTING & DIRECT MOUNTING (TYPE D)

4.1 ADJUSTABLE FITTER MOUNTING

Step 1: Remove the spare parts from A&D bracket. (Figure 17).

Step 2: Loosen the four bolts on A&D bracket, connect the wires correctly, and pull the wires into the poles. (Figure 18)

Step 3: Place the bracket into the pole and lock the four bolts. (Figure 18)

Notice: Adjustable angle is 0-90° (Figure 18)

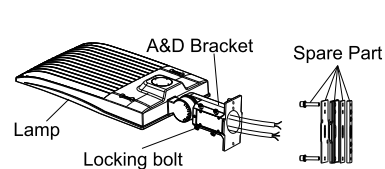

Figure 17

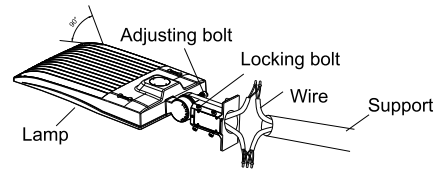

Figure 18

4.2 DIRECT MOUNTING

Step 1: Remove the four bolts from A&D bracket, remove the four rubber plugs from installation bar, put the four rubber plugs on the place where the four bolts were previously placed on the bracket for waterproof purpose (Figure 19)

Step 2: Fix A&D bracket to square pole with bolt, open the cover of A&D bracket junction box, pull the wire into bracket junction box, connect the wire properly and cover the junction box. (Figure 20)

Notice: Adjustable angle is 0-90°. (Figure 20)

Same as round pole installation, please remember to use the adapting plate for round pole installation (Figure 21)

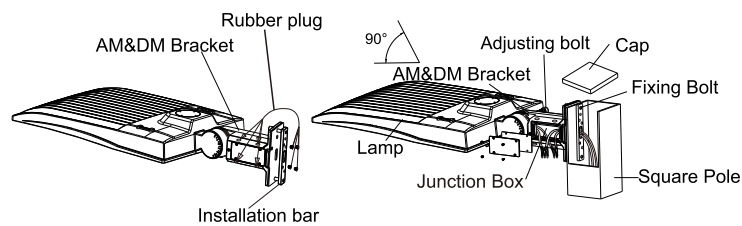

Figure 19

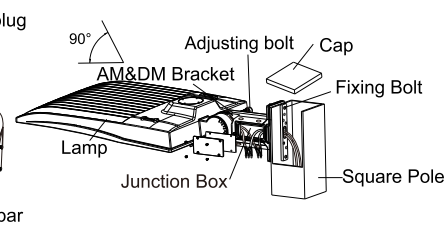

Figure 20

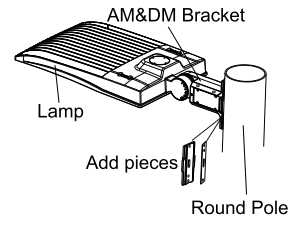

Figure 21

Standard wire:

L/live wire: Black\Brown;
N/null wire: White\Blue;
Ground wire: Green\Yellow-green.

MIN 75 °C SUPPLY CONDUCTOR

THIS PRODUCT MUST BE INSTALLED IN ACCORDANCE WITH THE APPLICABLE INSTALLATION CODE BY A PERSON FAMILIAR WITH THE CONSTRUCTION AND OPERATION OF THE PRODUCT AND THE HAZARDS INVOLVED.

LES FILS D'ALIMENTATION 75 °C MIN

CE PRODUIT DOIT ÊTRE INSTALLÉ SELON LE CODE D'INSTALLATION PERTINENT, PAR UNE PERSONNE QUI CONNAÎT BIEN LE PRODUIT ET SON FONCTIONNEMENT AINSI QUE LES RISQUES INHÉRENTS.

Instructions for Photocell

When the photocell function is required, photocell should be installed on the back of lamp; When it's not required, shorting cap should be installed on the back of lamp (Figure 22)

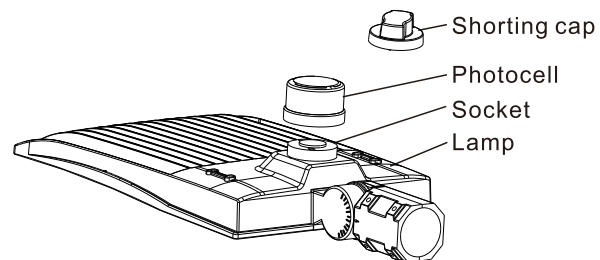
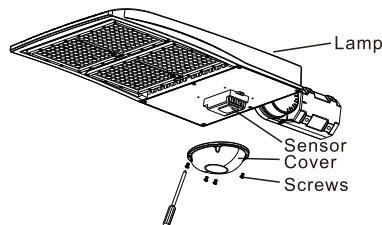

Figure 22

Instructions for Motion sensor

Open the cover above motion sensor by loosen the screws; Set the motion sensor through DIP switches as per actual requirements; Lock the cover above the motion sensor through screws;



Structure of motion sensor

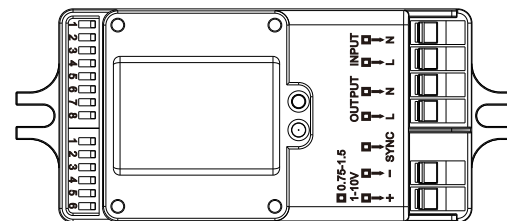
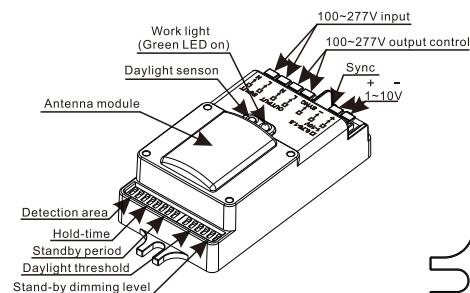

Function of DIP switches:

ON ↑		1	2	
	I	ON	ON	100%
	II	ON	-	75%
	III	-	ON	50%
IV	-	-	-	10%

ON ↑		3	4	5	
	I	ON	ON	ON	5s
	II	-	ON	ON	30s
	III	ON	-	ON	90s
	IV	-	-	ON	3min
	V	ON	ON	-	20min
VI	-	-	-	+∞	

ON ↑		6	7	8	
	I	ON	ON	ON	0s
	II	-	ON	ON	5s
	III	ON	-	ON	5min
	IV	-	-	ON	10min
	V	ON	ON	-	30min
	VI	-	ON	-	1h
VII	-	-	-	+∞	

ON ↑		1	2	3	4	
	I	-	-	ON	ON	2Lux
	II	-	-	-	ON	5Lux
	III	-	ON	ON	-	10Lux
	IV	-	-	ON	-	25Lux
	V	-	ON	-	-	50Lux
	VI	ON	-	-	-	100Lux
VII	-	-	-	-	Disable	

ON ↑		5	6	
	I	ON	ON	50%
	II	-	ON	30%
	III	ON	-	20%
IV	-	-	-	10%

Detection area

Detection area can be reduced by selecting the combination on the DIP switches to fit precisely each application.

Factory setting: I

Hold time

Refers to the time period the lamp remains at 100% illumination after no motion detected.

Factory setting: I

Stand-by period

Refers to the time period the lamp remains at a low light level before it completely switches off in the long absence of people.

When set to "+∞" mode, the low light is maintained until motion is detected.

Factory setting: I

Daylight sensor

The sensor can be set to only allow the lamp to illuminate below a defined ambient brightness threshold.

When set to Disable mode, the daylight sensor will switch on the lamp when motion is detected regardless of ambient light level.

50lux, 30lux: twilight operation, 10lux, 5lux: operation only.

Note that daylight sensor is active only when lamp totally switches off.

Factory setting: VII

Stand-by dimming level

The low light level you would like to have after the hold time in the long absence of people.

Factory setting: I