

MESTM

LIGHTING. CONTROLS. SOLAR.

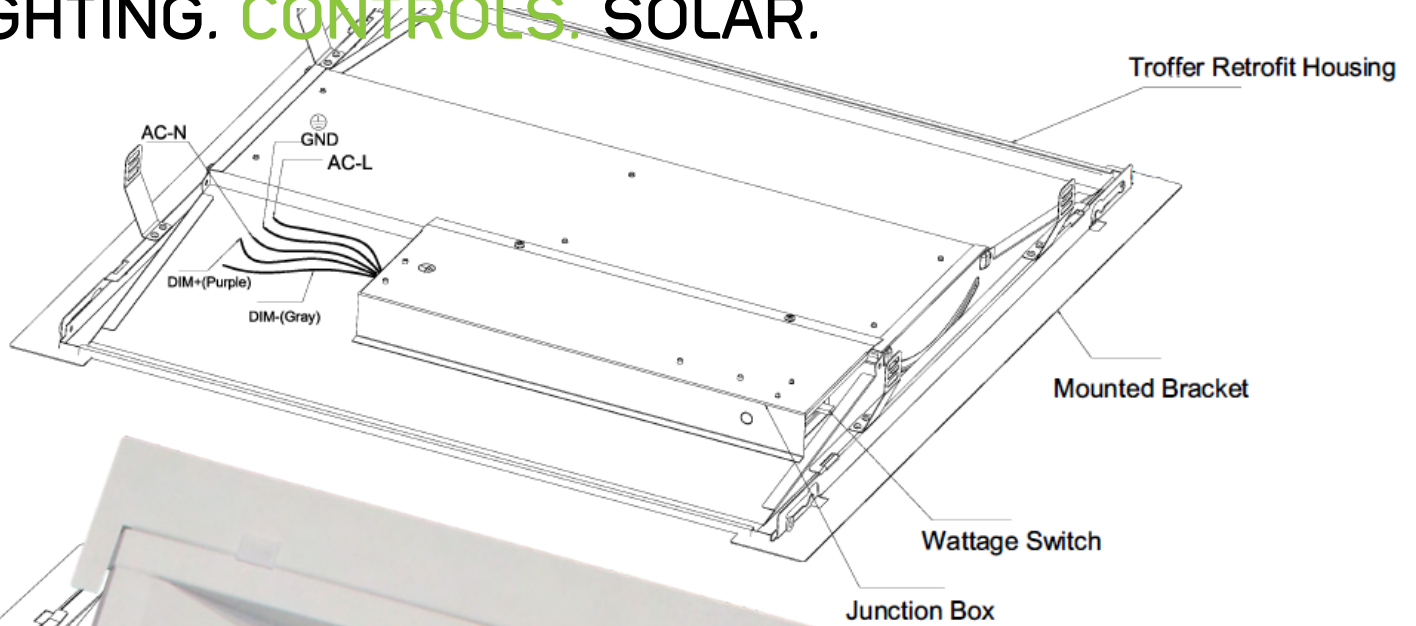

**NEW Marigold S
Troffer Retrofit**
Pg. 25

PRODUCT CATALOG 2021

maverickled.com | 214.571.6374 | info@maverickled.com

MESTM

BUILDING'S LIFE COACH

Our Philosophy: Building's Life CoachTM

Our vision is to be an industry leading, innovative, and disruptive "Building Life CoachTM"

As a Building Life Coach, our commitment is to be the world's only LED Lighting Manufacturer, Solar Manufacturer and Roof Consulting & Rehabilitation company that provides our channel partner clients with a consultative, solution based, value added, energy and time saving solution at a fair price. Being customer centric and internally driven, we will act green in everything we do, and we will constantly adapt to be able to solve our client's building issues for the next 15 years.

Finally, we will be the best at training our channel partners to consistently deliver value added energy conservation measures (ECM's) and solutions to their clients.

Core Values

ADAPT: NO EXCUSE

Quickly adjust to meet new challenges without excuse

OVER AND ABOVE

Embrace every opportunity to contribute more

INTERNALLY DRIVEN

Self-motivated to lead and help where needed

TEACH ME MORE

Always open to learning and sharing new ideas and methods

Core FocusTM

Our Purpose, Cause and Passion

Helping people create "A-Ha" moments

Our Niche

Providing Energy Solutions

10 Year TargetTM

Our goal is to provide Energy Solutions within 250,000 buildings/properties by 2030



Our Strategic Partnerships



TABLE OF CONTENTS

What's New	Pg. 7
Indoor Retrofit	Pg. 10
HID Retrofit	Pg. 26
Outdoor Retrofit	Pg. 30
Indoor Fixtures	Pg. 32
High Bay Fixtures	Pg. 44
Outdoor Fixtures	Pg. 51
Tenons & Mounts	Pg. 72
Controls & Sensors	Pg. 74
Refrigeration	Pg. 76
Specialty Lighting	Pg. 79
Solar	Pg. 80
Emergency Drivers	Pg. 82

WHAT'S NEW

MES strives to stay at the forefront of LED lighting innovations, with an emphasis on quality and efficiency. We're excited to offer new products that are either sensor-ready, CCT Tunable, watt-selectable and more!

Our aim is to provide your business w/ cost-effective, energy-efficient lighting, designed for easy install and control, capable of adding a touch of beauty to any environment for years to come. Our standard **7-Year Warranty** will provide a higher level of quality assurance and value in every lighting category.

As you take a peek inside, we hope you like what you see. When you're ready to order, remember we're just a click away at maverickled.com or just a phone call away at **214.571.6374**



SOLAR PANELS

- Available in monofacial, bifacial, mono and poly
- Suitable for ground and rooftop installations

P. 80



BIRCH SSR LED BACKLIT FLAT PANELS

- PIR Sensor Ready

P. 39



WILLOW G LED DOWNLIGHT

- Available in 4", 6", 8" and 10"
- Selectable Wattage
- CCT Tunable

P. 41



MARIGOLD S VOLUMETRIC TROFFER RETROFIT

- PIR Sensor Ready

P. 25



MES GLOSSARY

Look for the following features on our line of products:



Dimmable
The Dimmable symbol denotes MES products with dimming capabilities.

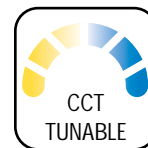

Correlated Color Temperature (CCT) Tunable
MES products with the CCT Tunable badge have the ability to deliver varying light color. Using a remote control, you are able to select the desired color of white anywhere between 3000K - 5000K.



High Lumen
Products with the Selectable Wattage badge offer energy-efficient, cost-saving solutions by allowing users the ability to quickly decrease or increase the LED wattage.



Patent Pending
Products that display this badge has original, MES-created technology pending a patent, but ready for commercial use.



Selectable Wattage
Products with the Selectable Wattage badge offer energy-efficient cost-saving solutions by allowing users the ability to quickly decrease or increase the LED wattage.



Sensor Ready
MES products with the Sensor Ready badge come with designated receptacles allowing quick and convenient sensor plug in.



MES Standard 7-Year Product Warranty
MES fixtures come standard with a best-in-class 7-year warranty.



MES Optional 10-Year Product Warranty
MES offers an optional 10-year warranty for products and labor.

IP RATINGS

IP ratings featured on our line of products:



IP20
MES products w/ this rating are protected against being touched by hand or large tools.



IP44
MES products w/ this rating offer protection against invasive small objects larger than 1mm, such as a wire, and protected against splashes of water projected from any direction.



IP54
MES products w/ this rating are protected against dust and splashes of water from any direction.



IP64
MES products w/ this rating are dust-resistant and protected against splashes of water from any direction.



IP65
MES products w/ this rating are dust-resistant and protected against jets of water projected from any direction.



IP67
MES products w/ this rating are dust-resistant and fully protected against immersion in water for 30 minutes to a depth of 1 meter.

CERTIFICATIONS



For more than 100 years, Underwriters Laboratories has been non-profit organization dedicated to public safety. UL sets standards for different product categories and tests products to make sure they meet the standards.

The ETL Mark is proof of product compliance to North America safety standards. Authorities Having Jurisdiction (AHJs) and code officials across the US and Canada accept ETL Listed Mark as proof of product compliance to published industry standards.

To see MES products in this catalog that meet UL or ETL standards, look for the UL or ETL badge.

DesignLights Consortium®

The DesignLights Consortium (DLC) is a non-profit organization promoting high-quality, energy-efficient lighting products in collaboration w/ utilities and energy-efficiency program members, manufacturers, lighting designers, and federal, state and local entities.

To find MES products in this catalog that meet DLC standards, look for the DLC badge.

LED TYPE A, B, A+B TUBES

Description:

LED Type A, B, A+B tubes are ideal for customers with older fluorescent ballasts who want to maximize efficiency with high system efficacy, guaranteed system compatibility, and the greatest overall performance.

Features:

- Frosted glass; eliminates pixelation
- Instant startup
- Suitable for retail, schools, offices, healthcare and other various commercial applications



Order Code	Product	Tube Type	Wattage	CCT	Voltage	Color	Function
------------	---------	-----------	---------	-----	---------	-------	----------

Non-Dimmable

02061	LED 4ft Glass Tube	Type A	13W	4000K	100-277V	White	Non-Dimmable
02062	LED 4ft Glass Tube	Type A	13W	5000K	100-277V	White	Non-Dimmable
02071	LED 4ft Glass Tube	Type B	13W	4000K	100-277V	White	Non-Dimmable
02072	LED 4ft Glass Tube	Type B	13W	5000K	100-277V	White	Non-Dimmable
02081	LED 4ft Glass Tube	Type A+B	15W	4000K	100-277V	White	Non-Dimmable
02082	LED 4ft Glass Tube	Type A+B	15W	5000K	100-277V	White	Non-Dimmable



**DLC CERTIFICATION
PENDING END OF
MAY 2021**

Order Code	Product	Tube Type	Wattage	CCT	Voltage	Color	Function
------------	---------	-----------	---------	-----	---------	-------	----------

Non-Dimmable

09230	LED 2ft Glass Tube	Type B	6W	4000K	100-277V	White	Non-Dimmable
09231	LED 2ft Glass Tube	Type B	6W	5000K	100-277V	White	Non-Dimmable
09232	LED 4ft Glass Tube	Type B	*9W	4000K	100-277V	White	Non-Dimmable
09233	LED 4ft Glass Tube	Type B	*9W	5000K	100-277V	White	Non-Dimmable
09234	LED 4ft Glass Tube	Type A+B	*9W	4000K	100-277V	White	Non-Dimmable
09235	LED 4ft Glass Tube	Type A+B	*9W	5000K	100-277V	White	Non-Dimmable

***9W Tubes available end of June 2021**

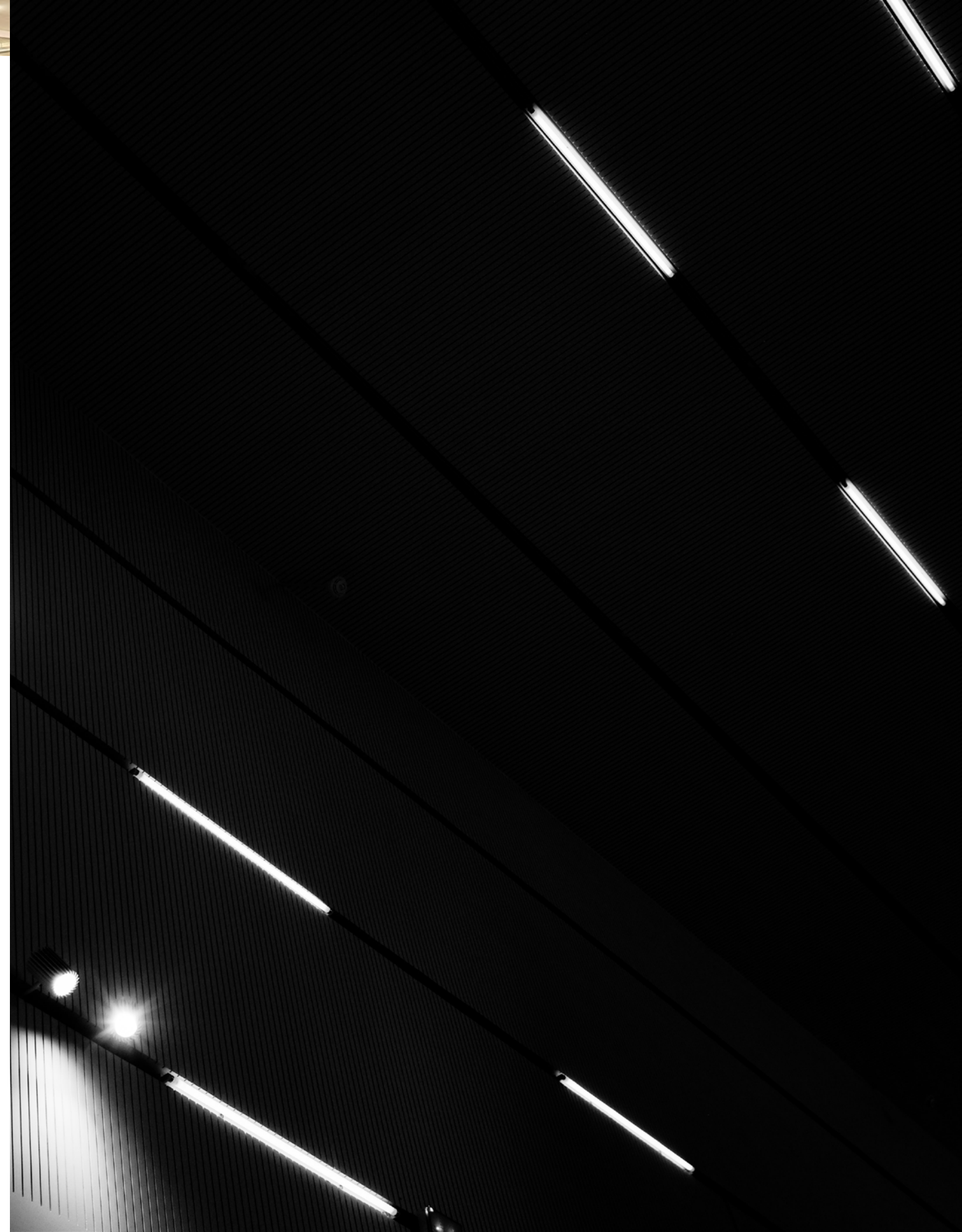

LED TYPE C TUBES RETROFIT



Description:

Our External Drive LED Type C tubes are ideal for customers with older fluorescent ballasts who want to maximize efficiency, but don't want to install Type B linear voltage retrofit lamps. Our External Drive LED system can be integrated with robust dimming and control functionality. Our Type C LED tubes offer high system efficacy, guaranteed system compatibility, and the greatest overall performance.

Features:

- Frosted glass; eliminates pixelation
- Instant startup
- Suitable for retail, schools, offices, healthcare and other various commercial applications



Order Code	Product	Wattage	Number of Tubes	CCT	Voltage	Color	Function
------------	---------	---------	-----------------	-----	---------	-------	----------

Non-Dimmable

03902*	LED 4ft Glass T8 Type C Tube	12W	1 Tube	4000K	100-277V	White	Non-Dimmable
03903*	LED 4ft Glass T8 Type C Tube	12W	1 Tube	5000K	100-277V	White	Non-Dimmable
03907*	LED 4ft Glass T8 Type C Tube	24W	2 Tube	4000K	100-277V	White	Non-Dimmable
03908*	LED 4ft Glass T8 Type C Tube	24W	2 Tube	5000K	100-277V	White	Non-Dimmable
03912*	LED 4ft Glass T8 Type C Tube	36W	3 Tube	4000K	100-277V	White	Non-Dimmable
03913*	LED 4ft Glass T8 Type C Tube	36W	3 Tube	5000K	100-277V	White	Non-Dimmable
03920*	LED 4ft Glass T8 Type C Tube	48W	4 Tube	4000K	100-277V	White	Non-Dimmable
03921*	LED 4ft Glass T8 Type C Tube	48W	4 Tube	5000K	100-277V	White	Non-Dimmable

*while supplies last

Order Code	Product	Wattage	Number of Tubes	CCT	Voltage	Color	Function
------------	---------	---------	-----------------	-----	---------	-------	----------

2 Foot - Non-Dimmable

03952	LED 2ft Glass T8 Type C Tube	10W	1 Tube	4000K	100-277V	White	Non Dim Kit
03953	LED 2ft Glass T8 Type C Tube	10W	1 Tube	5000K	100-277V	White	Non Dim Kit
03900	LED 2ft Glass T8 Type C Tube	20W	2 Tube	4000K	100-277V	White	Non Dim Kit
03901	LED 2ft Glass T8 Type C Tube	20W	2 Tube	5000K	100-277V	White	Non Dim Kit

4 Foot - Non-Dimmable

13940	LED 4ft Glass T8 Type C Tube	13W	1 Tube	4000K	100-277V	White	Non Dim Kit
13941	LED 4ft Glass T8 Type C Tube	13W	1 Tube	5000K	100-277V	White	Non Dim Kit
13942	LED 4ft Glass T8 Type C Tube	15W	1 Tube	4000K	100-277V	White	Non Dim Kit
13943	LED 4ft Glass T8 Type C Tube	15W	1 Tube	5000K	100-277V	White	Non Dim Kit
13944	LED 4ft Glass T8 Type C Tube	26W	2 Tube	4000K	100-277V	White	Non Dim Kit
13945	LED 4ft Glass T8 Type C Tube	26W	2 Tube	5000K	100-277V	White	Non Dim Kit
03909	LED 4ft Glass T8 Type C Tube	30W	2 Tube	4000K	100-277V	White	Non Dim Kit
03910	LED 4ft Glass T8 Type C Tube	30W	2 Tube	5000K	100-277V	White	Non Dim Kit
03948	LED 4ft Glass T8 Type C Tube	52W	4 Tube	4000K	100-277V	White	Non Dim Kit
03949	LED 4ft Glass T8 Type C Tube	52W	4 Tube	5000K	100-277V	White	Non Dim Kit
03918	LED 4ft Glass T8 Type C Tube	60W	4 Tube	4000K	100-277V	White	Non Dim Kit
03919	LED 4ft Glass T8 Type C Tube	60W	4 Tube	5000K	100-277V	White	Non Dim Kit

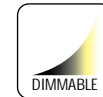

Order Code	Product	Wattage	Number of Tubes	CCT	Voltage	Color	Function
------------	---------	---------	-----------------	-----	---------	-------	----------

13965	LED 4ft Glass T8 Type C Tube	13W	1 Tube	4000K	100-277V	White	Dim Kit
13966	LED 4ft Glass T8 Type C Tube	13W	1 Tube	5000K	100-277V	White	Dim Kit
13967	LED 4ft Glass T8 Type C Tube	15W	1 Tube	4000K	100-277V	White	Dim Kit
13968	LED 4ft Glass T8 Type C Tube	15W	1 Tube	5000K	100-277V	White	Dim Kit
13969	LED 4ft Glass T8 Type C Tube	26W	2 Tube	4000K	100-277V	White	Dim Kit
13970	LED 4ft Glass T8 Type C Tube	26W	2 Tube	5000K	100-277V	White	Dim Kit
13971	LED 4ft Glass T8 Type C Tube	30W	2 Tube	4000K	100-277V	White	Dim Kit
13972	LED 4ft Glass T8 Type C Tube	30W	2 Tube	5000K	100-277V	White	Dim Kit
13973	LED 4ft Glass T8 Type C Tube	52W	4 Tube	4000K	100-277V	White	Dim Kit
13974	LED 4ft Glass T8 Type C Tube	52W	4 Tube	5000K	100-277V	White	Dim Kit
13975	LED 4ft Glass T8 Type C Tube	60W	4 Tube	4000K	100-277V	White	Dim Kit
13976	LED 4ft Glass T8 Type C Tube	60W	4 Tube	5000K	100-277V	White	Dim Kit

LIGHTING CONTROLS

Order Code	Description	Height	Voltage	Color	Version	Function
06210	3-in-1 Microwave Fixture Embedded w/ Detachable Sensor	19ft	120-277V	White	Standard	3-in-1
06278	LED Intelligent Remote Control	-	-	White	Standard	LCD Display

LED MAGNETIC STRIP RETROFIT (HIGH LUMEN)

Description:

Our High Lumen Magnetic Strip Retro series is a family of LED Magnetic retrofit kits, which are used to update existing 2x4 fluorescent luminaires to LED. This family of retrofit also simplifies installation: simply replace your fluorescent tubes with the Magnetic Strips and the fixture's ballast with the included high-performance LED driver. Installation can be completed in as little as 5 minutes. These kits includes LED Strips, an external driver, a connector, and attached magnets for a quick install

Features:

- LED strips, LED drivers, connector
- Suitable for retail, schools, offices, healthcare, and other various commercial applications



HIGH LUMEN MAGNETIC STRIPS



Order Code (Clear Lens)	Order Code (Frosted Lens)	Description	Strip Count	Wattage	CCT	Color	Function
-------------------------	---------------------------	-------------	-------------	---------	-----	-------	----------

2ft Magnetic Strips

09800	09801	LED 2ft Magnetic Strip Retrofit	7W	1 Strip	4000K	White	Dimmable/SR
09802	09803	LED 2ft Magnetic Strip Retrofit	7W	1 Strip	5000K	White	Dimmable/SR
09804	09805	LED 2ft Magnetic Strip Retrofit	14W	2 strip	4000K	White	Dimmable/SR
09806	09807	LED 2ft Magnetic Strip Retrofit	14W	2 strip	5000K	White	Dimmable/SR
09808	09809	LED 2ft Magnetic Strip Retrofit	21W	3 strip	4000K	White	Dimmable/SR
09810	09811	LED 2ft Magnetic Strip Retrofit	21W	3 strip	5000K	White	Dimmable/SR

4ft Magnetic Strips

09812	09813	LED 4ft Magnetic Strip Retrofit	9W	1 strip	4000K	White	Dimmable/SR
09814	09815	LED 4ft Magnetic Strip Retrofit	9W	1 strip	5000K	White	Dimmable/SR
09816	09817	LED 4ft Magnetic Strip Retrofit	12W	1 strip	4000K	White	Dimmable/SR
09818	09819	LED 4ft Magnetic Strip Retrofit	12W	1 strip	5000K	White	Dimmable/SR
04647	04651	LED 4ft Magnetic Strip Retrofit	18W	2 strip	4000K	White	Dimmable/SR
04655	04659	LED 4ft Magnetic Strip Retrofit	18W	2 strip	5000K	White	Dimmable/SR
04663	04668	LED 4ft Magnetic Strip Retrofit	24W	2 strip	4000K	White	Dimmable/SR
04673	04678	LED 4ft Magnetic Strip Retrofit	24W	2 strip	5000K	White	Dimmable/SR
03649	03654	LED 4ft Magnetic Strip Retrofit	27W	3 strip	4000K	White	Dimmable/SR
13649	13654	LED 4ft Magnetic Strip Retrofit	27W	3 strip	5000K	White	Dimmable/SR
04664	04669	LED 4ft Magnetic Strip Retrofit	36W	3 strip	4000K	White	Dimmable/SR
04674	04679	LED 4ft Magnetic Strip Retrofit	36W	3 strip	5000K	White	Dimmable/SR
03652	03657	LED 4ft Magnetic Strip Retrofit	36W	4 strip	4000K	White	Dimmable/SR
13652	13657	LED 4ft Magnetic Strip Retrofit	36W	4 strip	5000K	White	Dimmable/SR
04665	04670	LED 4ft Magnetic Strip Retrofit	48W	4 strip	4000K	White	Dimmable/SR
04675	04680	LED 4ft Magnetic Strip Retrofit	48W	4 strip	5000K	White	Dimmable/SR

LIGHTING CONTROLS

Order Code	Description	Height	Voltage	Color	Version	Function
06243	DC Powered 3 in 1 Microwave Control for Sensor Ready Magnetic Strips and Flat Panels	19ft	10-15 VDC	White	Sensor Ready	3-in-1
06258	DC Powered 3 in 1 PIR Control for Sensor Ready Magnetic Strips and Flat Panels	19ft	10-15 VDC	White	Sensor Ready	3-in-1
06278	LED Intelligent Remote Control	-	-	White	Standard	LCD Display



HIGH LUMEN MAGNETIC STRIPS

Order Code (Clear Lens)	Order Code (Frosted Lens)	Description	Strip Count	Wattage	CCT	Color	Function
-------------------------	---------------------------	-------------	-------------	---------	-----	-------	----------

2ft Magnetic Strips

09700	09701	LED 2ft Magnetic Strip Retrofit	7W	1 Strip	4000K	White	Dimmable
09702	09703	LED 2ft Magnetic Strip Retrofit	7W	1 Strip	5000K	White	Dimmable
09704	09705	LED 2ft Magnetic Strip Retrofit	14W	2 strip	4000K	White	Dimmable
09706	09707	LED 2ft Magnetic Strip Retrofit	14W	2 strip	5000K	White	Dimmable
09708	09709	LED 2ft Magnetic Strip Retrofit	21W	3 strip	4000K	White	Dimmable
09710	09711	LED 2ft Magnetic Strip Retrofit	21W	3 strip	5000K	White	Dimmable

4ft Magnetic Strips

09712	09713	LED 4ft Magnetic Strip Retrofit	9W	1 Strip	4000K	White	Dimmable
09714	09715	LED 4ft Magnetic Strip Retrofit	9W	1 Strip	5000K	White	Dimmable
09716	09717	LED 4ft Magnetic Strip Retrofit	12W	1 Strip	4000K	White	Dimmable
09718	09719	LED 4ft Magnetic Strip Retrofit	12W	1 Strip	5000K	White	Dimmable
03647	03651	LED 4ft Magnetic Strip Retrofit	18W	2 strip	4000K	White	Dimmable
03655	03659	LED 4ft Magnetic Strip Retrofit	18W	2 strip	5000K	White	Dimmable
03663	03668	LED 4ft Magnetic Strip Retrofit	24W	2 strip	4000K	White	Dimmable
03673	03678	LED 4ft Magnetic Strip Retrofit	24W	2 strip	5000K	White	Dimmable
03648	03653	LED 4ft Magnetic Strip Retrofit	27W	3 strip	4000K	White	Dimmable
13648	13653	LED 4ft Magnetic Strip Retrofit	27W	3 strip	5000K	White	Dimmable
03664	03669	LED 4ft Magnetic Strip Retrofit	36W	3 strip	4000K	White	Dimmable
03674	03679	LED 4ft Magnetic Strip Retrofit	36W	3 strip	5000K	White	Dimmable
03650	13650	LED 4ft Magnetic Strip Retrofit	36W	4 strip	4000K	White	Dimmable
03656	13656	LED 4ft Magnetic Strip Retrofit	36W	4 strip	5000K	White	Dimmable
03665	03670	LED 4ft Magnetic Strip Retrofit	48W	4 strip	4000K	White	Dimmable
03675	03680	LED 4ft Magnetic Strip Retrofit	48W	4 strip	5000K	White	Dimmable

LIGHTING CONTROLS

Order Code	Description	Height	Voltage	Color	Version	Function
06210	3-in-1 Microwave Fixture Embedded w/ Detachable Sensor	19ft	120-277V	White	Standard	3-in-1
06278	LED Intelligent Remote Control	-	-	White	Standard	LCD Display



LED MAGNETIC STRIP RETROFIT (CHOICE)

Description:

The Magnetic Strip Retro series is a family of LED Magnetic retrofit kits, which are used to update existing 2x2 and 2x4 fluorescent luminaires to LED. This family of retrofit also simplifies installation: simply replace your fluorescent tubes with the Magnetic Strips and the fixture's ballast with the included high-performance LED driver. Installation can be completed in as little as 5 minutes. These kits include LED Strips, an external driver, a connector, and attached magnets for a quick install

Features:

- LED strips, LED drivers, connector
- Suitable for retail, schools, offices, healthcare, and other various commercial applications

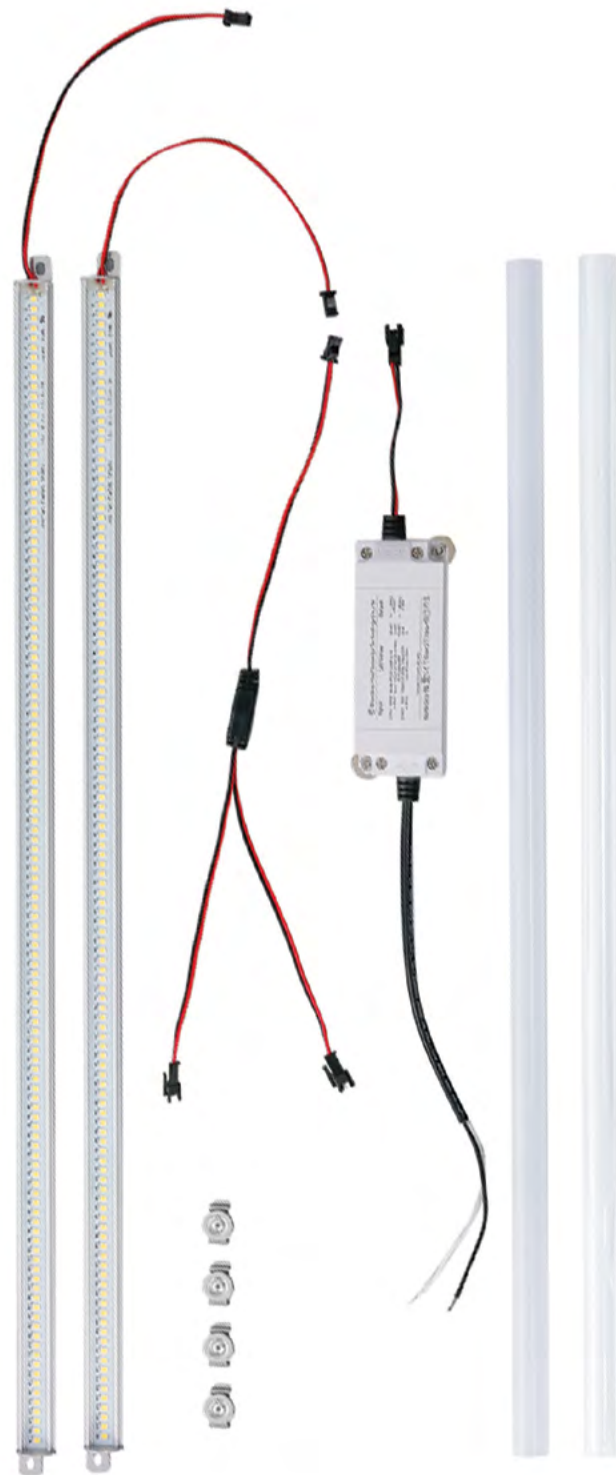

CHOICE MAGNETIC STRIPS



Order Code (Clear Lens)	Order Code (Frosted Lens)	Description	Watt-age	Strip Count	CCT	Voltage	Color	Function
-------------------------	---------------------------	-------------	----------	-------------	-----	---------	-------	----------

2' Magnetic Strips

04622	14622	LED 2ft Magnetic Strip Retrofit	20W	1 strip	3500K	100-277V	White	Dimmable/SR
04623	14623	LED 2ft Magnetic Strip Retrofit	20W	1 strip	4000K	100-277V	White	Dimmable/SR
04624	14624	LED 2ft Magnetic Strip Retrofit	20W	1 strip	5000K	100-277V	White	Dimmable/SR
04603	14603	LED 2ft Magnetic Strip Retrofit	30W	2 strip	3500K	100-277V	White	Dimmable/SR
04604	14604	LED 2ft Magnetic Strip Retrofit	30W	2 strip	4000K	100-277V	White	Dimmable/SR
04605	14605	LED 2ft Magnetic Strip Retrofit	30W	2 strip	5000K	100-277V	White	Dimmable/SR
04606	14606	LED 2ft Magnetic Strip Retrofit	40W	3 strip	3500K	100-277V	White	Dimmable/SR
04607	14607	LED 2ft Magnetic Strip Retrofit	40W	3 strip	4000K	100-277V	White	Dimmable/SR
04608	14608	LED 2ft Magnetic Strip Retrofit	40W	3 strip	5000K	100-277V	White	Dimmable/SR

4' Magnetic Strips

04625	14625	LED 4ft Magnetic Strip Retrofit	24W	1 strip	3500K	100-277V	White	Dimmable/SR
04626	14626	LED 4ft Magnetic Strip Retrofit	24W	1 strip	4000K	100-277V	White	Dimmable/SR
04627	14627	LED 4ft Magnetic Strip Retrofit	24W	1 strip	5000K	100-277V	White	Dimmable/SR
04628	14628	LED 4ft Magnetic Strip Retrofit	30W	2 strip	3500K	100-277V	White	Dimmable/SR
04629	14629	LED 4ft Magnetic Strip Retrofit	30W	2 strip	4000K	100-277V	White	Dimmable/SR
04630	14630	LED 4ft Magnetic Strip Retrofit	30W	2 strip	5000K	100-277V	White	Dimmable/SR
03631	14631	LED 4ft Magnetic Strip Retrofit	40W	2 strip	3500K	100-277V	White	Dimmable/SR
03633	14633	LED 4ft Magnetic Strip Retrofit	40W	2 strip	5000K	100-277V	White	Dimmable/SR
04634	14634	LED 4ft Magnetic Strip Retrofit	45W	3 strip	3500K	100-277V	White	Dimmable/SR
04635	14635	LED 4ft Magnetic Strip Retrofit	45W	3 strip	4000K	100-277V	White	Dimmable/SR
04636	14636	LED 4ft Magnetic Strip Retrofit	45W	3 strip	5000K	100-277V	White	Dimmable/SR
04637	14637	LED 4ft Magnetic Strip Retrofit	60W	3 strip	3500K	100-277V	White	Dimmable/SR
04638	14638	LED 4ft Magnetic Strip Retrofit	60W	3 strip	4000K	100-277V	White	Dimmable/SR
04639	14639	LED 4ft Magnetic Strip Retrofit	60W	3 strip	5000K	100-277V	White	Dimmable/SR
04640	14640	LED 4ft Magnetic Strip Retrofit	60W	4 strip	3500K	100-277V	White	Dimmable/SR
04641	14641	LED 4ft Magnetic Strip Retrofit	60W	4 strip	4000K	100-277V	White	Dimmable/SR
04642	14642	LED 4ft Magnetic Strip Retrofit	60W	4 strip	5000K	100-277V	White	Dimmable/SR

LIGHTING CONTROLS

Order Code	Description	Height	Voltage	Color	Version	Function
06243	DC Powered 3 in 1 Microwave Control for Sensor Ready Magnetic Strips and Flat Panels	19ft	10-15 VDC	White	Sensor Ready	3-in-1
06258	DC Powered 3 in 1 PIR Control for Sensor Ready Magnetic Strips and Flat Panels	19ft	10-15 VDC	White	Sensor Ready	3-in-1
06278	LED Intelligent Remote Control	-	-	White	Standard	LCD Display

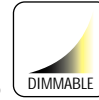

CHOICE MAGNETIC STRIPS

Order Code (Clear Lens)	Order Code (Frosted Lens)	Description	Wattage	Strip Count	CCT	Voltage	Color	Function
-------------------------	---------------------------	-------------	---------	-------------	-----	---------	-------	----------

2' Magnetic Strips

03600	13600	LED 2ft Magnetic Strip Retrofit	20W	1 strip	3500K	100-277V	White	Dimmable
03601	13601	LED 2ft Magnetic Strip Retrofit	20W	1 strip	4000K	100-277V	White	Dimmable
03602	13602	LED 2ft Magnetic Strip Retrofit	20W	1 strip	5000K	100-277V	White	Dimmable
03603	13603	LED 2ft Magnetic Strip Retrofit	30W	2 strip	3500K	100-277V	White	Dimmable
03604	13604	LED 2ft Magnetic Strip Retrofit	30W	2 strip	4000K	100-277V	White	Dimmable
03605	13605	LED 2ft Magnetic Strip Retrofit	30W	2 strip	5000K	100-277V	White	Dimmable
03606	13606	LED 2ft Magnetic Strip Retrofit	40W	3 strip	3500K	100-277V	White	Dimmable
03607	13607	LED 2ft Magnetic Strip Retrofit	40W	3 strip	4000K	100-277V	White	Dimmable
03608	13608	LED 2ft Magnetic Strip Retrofit	40W	3 strip	5000K	100-277V	White	Dimmable

4' Magnetic Strips

03625	13625	LED 4ft Magnetic Strip Retrofit	24W	1 strip	3500K	100-277V	White	Dimmable
03626	13626	LED 4ft Magnetic Strip Retrofit	24W	1 strip	4000K	100-277V	White	Dimmable
03627	13627	LED 4ft Magnetic Strip Retrofit	24W	1 strip	5000K	100-277V	White	Dimmable
03628	13628	LED 4ft Magnetic Strip Retrofit	30W	2 strip	3500K	100-277V	White	Dimmable
03629	13629	LED 4ft Magnetic Strip Retrofit	30W	2 strip	4000K	100-277V	White	Dimmable
03630	13630	LED 4ft Magnetic Strip Retrofit	30W	2 strip	5000K	100-277V	White	Dimmable
03631	13631	LED 4ft Magnetic Strip Retrofit	40W	2 strip	3500K	100-277V	White	Dimmable
03632	13632	LED 4ft Magnetic Strip Retrofit	40W	2 strip	4000K	100-277V	White	Dimmable
03633	13633	LED 4ft Magnetic Strip Retrofit	40W	2 strip	5000K	100-277V	White	Dimmable
03634	13634	LED 4ft Magnetic Strip Retrofit	45W	3 strip	3500K	100-277V	White	Dimmable
03635	13635	LED 4ft Magnetic Strip Retrofit	45W	3 strip	4000K	100-277V	White	Dimmable
03636	13636	LED 4ft Magnetic Strip Retrofit	45W	3 strip	5000K	100-277V	White	Dimmable
03637	13637	LED 4ft Magnetic Strip Retrofit	60W	3 strip	3500K	100-277V	White	Dimmable
03638	13638	LED 4ft Magnetic Strip Retrofit	60W	3 strip	4000K	100-277V	White	Dimmable
03639	13639	LED 4ft Magnetic Strip Retrofit	60W	3 strip	5000K	100-277V	White	Dimmable
03640	13640	LED 4ft Magnetic Strip Retrofit	60W	4 strip	3500K	100-277V	White	Dimmable
03641	13641	LED 4ft Magnetic Strip Retrofit	60W	4 strip	4000K	100-277V	White	Dimmable
03642	13642	LED 4ft Magnetic Strip Retrofit	60W	4 strip	5000K	100-277V	White	Dimmable
03643	13643	LED 4ft Magnetic Strip Retrofit	80W	4 strip	3500K	100-277V	White	Dimmable
03644	13644	LED 4ft Magnetic Strip Retrofit	80W	4 strip	4000K	100-277V	White	Dimmable
03645	13645	LED 4ft Magnetic Strip Retrofit	80W	4 strip	5000K	100-277V	White	Dimmable

LIGHTING CONTROLS

Order Code	Description	Height	Voltage	Color	Version	Function
06210	3-in-1 Microwave Fixture Embedded w/ Detachable Sensor	19ft	120-277V	White	Standard	3-in-1
06278	LED Intelligent Remote Control	-	-	White	Standard	LCD Display

CHOICE MAGNETIC STRIPS - NON-DIMMABLE

Order Code (Clear Lens)	Order Code (Frosted Lens)	Description	Wattage	Strip Count	CCT	Voltage	Color	Function
-------------------------	---------------------------	-------------	---------	-------------	-----	---------	-------	----------

4' Magnetic Strips

03737	13737	LED 4ft Magnetic Strip Retrofit	60W	3 strip	3500K	100-277V	White	Non-Dimmable
03738	13738	LED 4ft Magnetic Strip Retrofit	60W	3 strip	4000K	100-277V	White	Non-Dimmable
03739	13739	LED 4ft Magnetic Strip Retrofit	60W	3 strip	5000K	100-277V	White	Non-Dimmable
03740	13740	LED 4ft Magnetic Strip Retrofit	60W	4 strip	3500K	100-277V	White	Non-Dimmable
03741	13741	LED 4ft Magnetic Strip Retrofit	60W	4 strip	4000K	100-277V	White	Non-Dimmable
03742	13742	LED 4ft Magnetic Strip Retrofit	60W	4 strip	5000K	100-277V	White	Non-Dimmable
03743	13743	LED 4ft Magnetic Strip Retrofit	80W	4 strip	3500K	100-277V	White	Non-Dimmable
03744	13744	LED 4ft Magnetic Strip Retrofit	80W	4 strip	4000K	100-277V	White	Non-Dimmable
03745	13745	LED 4ft Magnetic Strip Retrofit	80W	4 strip	5000K	100-277V	White	Non-Dimmable



LED T8 INTEGRATED FIXTURE

Description:

Our LED T8 Integrated Fixture performs efficiently in conditions where low voltage, halogen, or fluorescent luminaries have traditionally been used. Our Integrated fixture incorporate integral drivers, are self-supporting, and can be surface mounted. Individual units can be plugged together for continuous lengths up to 36 feet. This LED T8 Integrated Fixture connects directly to line voltage and can be used in any interior space.

Features:

- Durable aluminum allow & PC cover
- Suitable for warehouse, factory, workshop or supermarket



Order Code	Description	Wattage	CCT	Voltage	Lens	Color	Function
02332*	LED 4ft Integrated Fixture Kit	22W	4000K	100-277V	Frosted Lens	White	Non Dimmable
02333*	LED 4ft Integrated Fixture Kit	22W	5000K	100-277V	Frosted Lens	White	Non Dimmable
02334*	LED 4ft Integrated Fixture Kit	22W	5000K	100-277V	Stripe Lens	White	Non Dimmable

*while supplies last

LIGHTING CONTROLS

Order Code	Description	Height	Voltage	Color	Connector	Function
06247	LED PIR Fixture Mounted Sensor	39ft	120-347V	White	Type D	Simple On/Off
06278	LED Intelligent Remote Control	-	-	White	Standard	LCD Display



LED STRIP FIXTURE RETROFIT

Description:

Our Strip Fixture Retrofit (SFR) kit includes everything needed for a seamless quick retrofit of existing 4' and 8' fluorescent strips along with other industrial fixtures to LED, in as little as two minute. It's the industry's fastest LED strip retrofit kit!. The SFR includes housing with pre-wired drivers, installation brackets, lenses, and hardware with each retrofit kit.

Features:

- AL+PC with an acrylic lens, removable for quick cleaning
- Suitable for retail, schools, offices, healthcare, and other various commercial applications

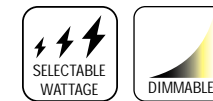

Order Code	Description	Wattage	CCT	Voltage	Color	Function
04003	LED 4ft Strip Fixture Retrofit	20W-30W-40W	4000K	100-277V	White	Dimmable
04004	LED 4ft Strip Fixture Retrofit	20W-30W-40W	5000K	100-277V	White	Dimmable

LIGHTING CONTROLS

Order Code	Description	Height	Voltage	Color	Version	Function
06210	3-in-1 Microwave Fixture Embedded w/ Detachable Sensor	19ft	120-277V	White	Standard	3-in-1
06221	LED Microwave Fixture Mounted Sensor	19ft	120-277V	White	Standard	3-in-1
06245	LED PIR Fixture Mounted Sensor	19ft	120-347V	White	Type D	3-in-1
06246	LED PIR Fixture Mounted Sensor	39ft	120-347V	White	Type D	3-in-1
06247	LED PIR Fixture Mounted Sensor	39ft	120-347V	White	Type D	Simple On/Off
06278	LED Intelligent Remote Control	-	-	White	Standard	LCD Display



LED VOLUMETRIC TROFFER RETROFIT

Description:

The Slim Line LED retrofit kit for troffers simplifies the conversion from existing fluorescent 2x2 and 2x4 recessed troffer fixtures to energy efficient LED fixtures using the back housing of the existing fixture. This Troffer Retrofit kit can be retrofitted into most existing troffers in less than 15 minutes.

Features:

- Mountable in an existing troffer fixture
- Durable steel housing with an acrylic lens that is removable for quick cleaning
- Suitable for retail, schools, offices, healthcare and other various commercial applications



Order Code	Description	Wattage	CCT	Voltage	Color	Function
04051*	LED 2x2 Volumetric Troffer Retrofit	36W	5000K	100-277V	White	Dimmable
04053*	LED 2x4 Volumetric Troffer Retrofit	36W	5000K	100-277V	White	Dimmable
04055*	LED 2x4 Volumetric Troffer Retrofit	36W-42W-50W	5000K	100-277V	White	Dimmable



Order Code	Description	Wattage	CCT	Voltage	Color	Function
04036	LED 2x4 Volumetric Troffer Retrofit	24W-36W-50W	4000K	100-277V	White	Dimmable/SR
04037	LED 2x4 Volumetric Troffer Retrofit	24W-36W-50W	5000K	100-277V	White	Dimmable/SR

LIGHTING CONTROLS

Order Code	Description	Height	Voltage	Color	Version	Function
06210	3-in-1 Microwave Fixture Embedded w/ Detachable Sensor (Compatible with 04050, 04051, 04052, 04054, 04055, 04056, 04057)	19ft	120-277V	White	Standard	3-in-1
06230	DC Powered 3 in 1 Microwave Control For Sensor Ready Troffer (Compatible with 04036, 04037)	19ft	10-15 VDC	White	Sensor Ready	3-in-1
06278	LED Intelligent Remote Control	-	-	White	Standard	LCD Display



LED VOLUMETRIC TROFFER RETROFIT (MARIGOLD S)

Description:

Our Marigold S slim line LED troffer retrofit comes is sensor ready with our 3-in-1 PIR sensor and is another perfect fixture for the conversion from existing fluorescent 2x2 and 2x4 recessed troffer fixtures to energy efficient LED fixtures.

Features:

- Troffer Retrofit kit can be retrofitted into most existing troffers in less than 15 minutes
- Continuous dimming (0-10V) comes standard
- Suitable for use with dimmers, sensors, daylight harvesting and other control strategies to achieve deeper energy-savings and code compliance



Order Code	Description	Wattage	CCT	Voltage	Color	Function
04060	LED 2x2 Volumetric Troffer Retrofit (Marigold S)	24W-36W	4000K	100-277V	White	Dimmable
04061*	LED 2x2 Volumetric Troffer Retrofit (Marigold S)	24W-36W	5000K	100-277V	White	Dimmable
04062	LED 2x4 Volumetric Troffer Retrofit (Marigold S)	24W- 36W-50W	4000K	100-277V	White	Dimmable
04063*	LED 2x4 Volumetric Troffer Retrofit (Marigold S)	24W- 36W-50W	5000K	100-277V	White	Dimmable

*Available end of June 2021

LIGHTING CONTROLS

Order Code	Description	Height	Voltage	Color	Version	Function
06230	DC Powered 3 in 1 Microwave Control For Sensor Ready Troffer (Compatible with 04036, 04037)	19ft	10-15 VDC	White	Sensor Ready	3-in-1
06278	LED Intelligent Remote Control	-	-	White	Standard	LCD Display

HID POST TOP RETROFIT

Description:

Our LED HID post top 360°retrofits are perfect for retrofitting your post top fixtures while providing 360° of high output LED light. These retrofit options are UL listed and enclosed fixture rated. With a reversible E39 mogul base, you can have either up or down light. Replace your metal halide lamps in your post top fixtures today with these beautiful LED replacements in 30 or 60 watts, available in 4000K or 5000K color temperature (CCT).

Features:

- E39 Mogul Base, die cast aluminum body with white finish
- Suitable for warehouses, gymnasiums, shopping centers



HID HIGH BAY RETROFIT

Description:

This LED HID High Bay Retrofit Light is the optimal replacement for the HID/HPS bulbs commonly found in high bay fixtures that light warehouses, gymnasiums, shopping centers, and more. No need to replace the fixture – simply bypass the ballast that’s powering the fixture, screw in the E39 base HID Retro Bay and restore power. Reduce maintenance costs and slash your energy bill with the high quality, uncompromising light of this commercial grade bulb.

Features:

- E39 Mogul Base, die cast aluminum body with white finish
- Suitable for warehouses, gymnasiums, shopping centers



Order Code	Description	Wattage	CCT	Voltage	Base	Lens
04425	LED Post Top HID Retrofit	30W	4000K	100-277V	E39 Base	Clear
04426	LED Post Top HID Retrofit	30W	5000K	100-277V	E39 Base	Clear
04427	LED Post Top HID Retrofit	60W	4000K	100-277V	E39 Base	Clear
04428	LED Post Top HID Retrofit	60W	5000K	100-277V	E39 Base	Clear

Order Code	Description	Wattage	CCT	Voltage	Base	Lens
04401*	LED High Bay HID Retrofit	100W	5000K	100-277V	E39 Base	Frosted

*while supplies last

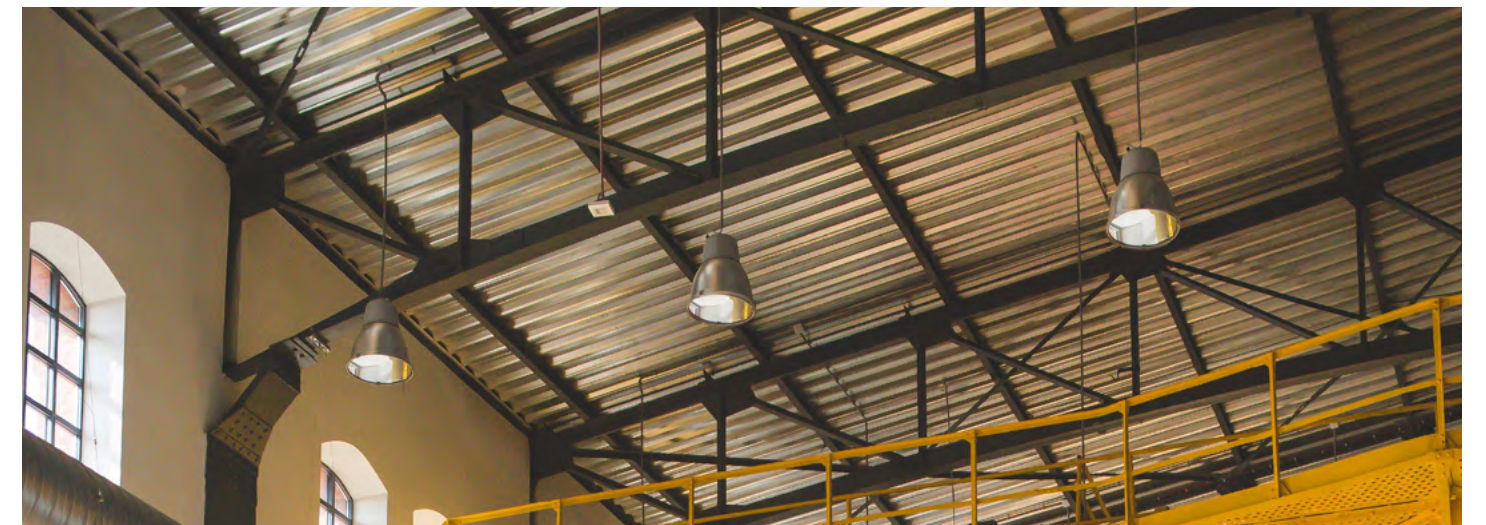



360° HID RETROFIT

Description:

Available in multiple wattages, these LED 360° HID Retro (Corn Cobb) Bulbs are a convenient and energy-efficient solution for replacing traditional high-pressure sodium and metal halide sources in enclosed lighting fixtures. Easy E39 Mogul base allows for quick installation. 360 degree beam angle fills your space with light in all directions. Instant On technology allows immediate lighting without wasted energy.

Features:

- Die-cast aluminum body with white finish
- Suitable for warehouses, gymnasiums, shopping centers



Order Code	Description	Wattage	CCT	Voltage	Base	Lens
04303*	LED HID 360 Retrofit Bulb	30W	5000K	100-277V	E39 Base	Clear
04304*	LED HID 360 Retrofit Bulb	40W	5000K	100-277V	E39 Base	Clear
04306*	LED HID 360 Retrofit Bulb	60W	5000K	100-277V	E39 Base	Clear
04308*	LED HID 360 Retrofit Bulb	80W	5000K	100-277V	E39 Base	Clear
04310*	LED HID 360 Retrofit Bulb	100W	5000K	100-277V	E39 Base	Clear
04312*	LED HID 360 Retrofit Bulb	150W	5000K	100-277V	E39 Base	Clear

*while supplies last



180° (PADDLE) HID RETROFIT

Description:

Use this LED retrofit lamp to easily convert metal-halide and other high-intensity discharge (HID) fixtures into super-bright, energy-efficient LED fixtures. Perfect for parking lot lights and wall packs. The rotatable bulb has an enhanced Type 3 lens that throws illumination where needed. The non-weatherproof bulb has an aluminum LED-cooling heat sink and shatterproof poly-carbonate lenses. A rotatable E39 mogul screw base allows for easy installation in fixtures (ballast can be removed or bypassed).

Features:

- E39 Mogul Base, rotatable base, 270°, safety wire
- Suitable for retrofit wall packs, Cobra heads, canopy lights & parking lot lights



Order Code	Description	Wattage	CCT	Voltage	Base	Lens
04375*	LED HID 180 Retrofit Bulb	36W	5000K	100-277V	E39 Base	Clear
04376*	LED HID 180 Retrofit Bulb	54W	5000K	100-277V	E39 Base	Clear
04377*	LED HID 180 Retrofit Bulb	75W	5000K	100-277V	E39 Base	Clear
04378*	LED HID 180 Retrofit Bulb	115W	5000K	100-277V	E39 Base	Clear

*while supplies last



HID OUTDOOR RETROFIT KIT WITH EXTERNAL DRIVER

Description:

This Outdoor Retrofit Kit is a multi-function retrofit solution for commercial and outdoor fixtures. Replace old metal halide fixtures with this LED retrofit kit and get up to 130 lumens per watt for better energy efficiency. The fixture can be mounted horizontal or vertical, and can be used to retrofit HID wall packs, shoebox area lights and flood lights, canopy lights, and high bays. Simply remove your old bulb, bypass the ballast, and mount the retrofit kit inside your fixture with the included bracket mount and hardware.

Features:

- Heavy duty one-piece die cast aluminum heat sink with an integral thermal control sensor with external Meanwell driver
- Retrofit: wall pack shoebox, flood light, canopy, high bay



Order Code	Description	Wattage	CCT	Voltage	Lens	Function
06004	LED Outdoor Retrofit Kit	60W	5000K	100-277V	-	Dimmable
06005	LED Outdoor Retrofit Kit	80W	5000K	100-277V	-	Dimmable
06006	LED Outdoor Retrofit Kit	100W	5000K	100-277V	-	Dimmable
06007	LED Outdoor Retrofit Kit	120W	5000K	100-277V	-	Dimmable
06008	LED Outdoor Retrofit Kit	150W	5000K	100-277V	-	Dimmable
06009	LED Outdoor Retrofit Kit	200W	5000K	100-277V	-	Dimmable
06010	LED Outdoor Retrofit Kit	240W	5000K	100-277V	-	Dimmable
06011	LED Outdoor Retrofit Kit	300W	5000K	100-277V	-	Dimmable



LED SOFFIT CANOPY RETROFIT

Description:

This slim and sleek LED Petroleum Canopy Light is a high performance fixture, capable retrofitting any soffit or canopy. Because of its unique design and features, it's the best outdoor lighting fixture applicable to any industrial or commercial premise but most particularly for gas stations. The 120-degree beam angle is perfect for illuminating large spaces without leaving dark spots. Comes with 12, 15, 18 inch plates in brown or white making it versatile for all applications.

Features:

- Die cast aluminum with integral heat sink
- Suitable for warehouse, factory, gas station, soffit, workshop



1. Choose fixture

2. Select plate size/color needed

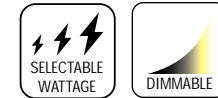

Order Code	Description	Wattage	CCT	Voltage	Color	Function
06100	LED Soffit Canopy (Fixture Only)	20W-30W-40W	5000K	120-277V	White	Dimmable

PLATES

Order Code	Description	CCT	Color
06115	LED Soffit Canopy Retrofit Plate	12x12	Bronze
06116	LED Soffit Canopy Retrofit Plate	15x15	Bronze
06117	LED Soffit Canopy Retrofit Plate	18x18	Bronze
06118	LED Soffit Canopy Retrofit Plate	12x12	White
06119	LED Soffit Canopy Retrofit Plate	15x15	White
06120	LED Soffit Canopy Retrofit Plate	18x18	White
06121	LED Soffit Canopy Retrofit Plate	22x22	White

LIGHTING CONTROLS

Order Code	Description	Height	Voltage	Color	Version	Function
06210	3-in-1 Microwave Fixture Embedded w/ Detachable Sensor	19ft	120-277V	White	Standard	3-in-1
06278	LED Intelligent Remote Control	-	4 Scenes	-	White	-

LED WRAPAROUND FIXTURE



Description:
The LED Wraparound is the classic, all-purpose fixture for nearly every commercial and industrial setting. It features a durable steel body construction with a white polyester powder coat finish, along with a prismatic lens that masks the LED diodes, delivering a smooth, visually appealing look. For a quick and economic replacement of T12 or T8 wraps, the LED Wraparound is the perfect solution.

- Features:**
- Durable steel body construction with white polyester powder coat finish
 - Suitable for corridors, offices, schools, stairwells, workshops

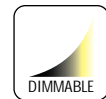

Order Code	Description	Wattage	CCT	Voltage	Color	Function
02470	LED 4ft Wraparound Fixture	40W	4000K	100-277V	White	Dimmable
02471	LED 4ft Wraparound Fixture	40W	5000K	100-277V	White	Dimmable

LIGHTING CONTROLS

Order Code	Description	Height	Voltage	Color	Version	Function
06221	LED Microwave Fixture Mounted Sensor	19ft	120-277V	White	Standard	3-in-1
06225	LED Microwave Fixture Mounted Sensor	49ft	347-480V	White	Standard	3-in-1
06245	LED PIR Fixture Mounted Sensor	19ft	120-347V	White	Type D	3-in-1
06246	LED PIR Fixture Mounted Sensor	39ft	120-347V	White	Type D	3-in-1
06247	LED PIR Fixture Mounted Sensor	39ft	120-347V	White	Type D	Simple On/Off
06278	LED Intelligent Remote Control	-	-	White	Standard	LCD Display



LED VAPOR TIGHT FIXTURE

Description:
Designed to be used in moisture-filled or harsh settings, these fixtures have a durable housing that resists warping, fading, corrosion, and rust. The impact resistant lenses are able to withstand the weather, and are held in place by non-corrosive metal clips. LED vapor tight fixtures use half the energy of fluorescents, lowering energy cost. These fixtures also eliminate lamp replacement costs and compatibility issues by using integrated LEDs.

- Features:**
- Fully gasketed polycarbonate housing with captive stainless steel latches
 - Suitable for gym, warehouse, parking garage, damp locations

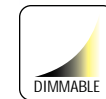

Order Code	Description	Wattage	CCT	Voltage	Color	Function
02521	LED 4FT Vapor Tight Fixture	32W	4000K	100-277V	White	Dimmable
02522	LED 4FT Vapor Tight Fixture	32W	5000K	100-277V	White	Dimmable

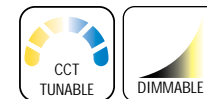

Order Code	Description	Wattage	CCT	Voltage	Color	Function
02523	LED 4FT Vapor Tight Fixture	32W	3000K 4000K 5000K	100-277V	White	Dimmable

LIGHTING CONTROLS

Order Code	Description	Height	Voltage	Color	Version	Function
06221	LED Microwave Fixture Mounted Sensor	19ft	120-277V	White	Standard	3-in-1
06225	LED Microwave Fixture Mounted Sensor	49ft	347-480V	White	Standard	3-in-1
06245	LED PIR Fixture Mounted Sensor	19ft	120-347V	White	Type D	3-in-1
06246	LED PIR Fixture Mounted Sensor	39ft	120-347V	White	Type D	3-in-1
06247	LED PIR Fixture Mounted Sensor	39ft	120-347V	White	Type D	Simple On/Off
06278	LED Intelligent Remote Control	-	-	White	Standard	LCD Display

LED COVERED STRIP FIXTURE

Description:

The LED Covered Strip Fixture, available in 4' and 8', is designed as a direct replacement for fluorescent strips. This luminaire delivers general ambient lighting in a variety of indoor settings, including schools, offices, hospitals and stores, and is the perfect choice for both new construction and retrofits. This luminaire provides long-life and uniform illumination, as well as standard 0-10VDC dimming capability.



Order Code	Description	Wattage	CCT	Voltage	Color	Function
02390*	LED 4ft Covered Strip Fixture	32W	4000K	100-277V	White	Dimmable

*while supplies last

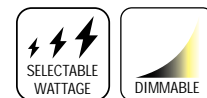

Order Code	Description	Wattage	CCT	Voltage	Color	Function
02393*	LED 4ft Covered Strip Fixture	24W-32W-40W	5000K	100-277V	White	Dimmable
02396*	LED 4ft Covered Strip Fixture	40W-65W	4000K	100-277V	White	Dimmable

*while supplies last



This sensor ready fixture uses sensor 06230

Order Code	Description	Wattage	CCT	Voltage	Color	Function
02377	LED 4FT Covered Strip Fixture	24W-32W-40W	4000K	100-277V	White	Dimmable/SR
02378	LED 4FT Covered Strip Fixture	24W-32W-40W	5000K	100-277V	White	Dimmable/SR
02379	LED 8FT Covered Strip Fixture	40W-65W	4000K	100-277V	White	Dimmable/SR
02380	LED 8ft Covered Strip Fixture	40W-65W	5000K	100-277V	White	Dimmable/SR



LIGHTING CONTROLS

Order Code	Description	Height	Voltage	Color	Version	Function
06221	LED Microwave Fixture Mounted Sensor	19ft	120-277V	White	Standard	3-in-1
06225	LED Microwave Fixture Mounted Sensor	49ft	347-480V	White	Standard	3-in-1
06230	DC Powered 3-in-1 Microwave Sensor for Sensor Ready Troffer	19ft	10-15 VDC	White	Sensor Ready	3-in-1
06245	LED PIR Fixture Mounted Sensor	19ft	120-347V	White	Type D	3-in-1
06246	LED PIR Fixture Mounted Sensor	39ft	120-347V	White	Type D	3-in-1
06247	LED PIR Fixture Mounted Sensor	39ft	120-347V	White	Type D	Simple On/Off
06278	LED Intelligent Remote Control	-	-	White	Standard	LCD Display



LED VOLUMETRIC TROFFER

Description:
Our dimmable, LED Troffer provides a quick and easy solution for warehouse and other commercial applications.

Available in 2'x2' and 2'x4' versions.

- Features:**
- Mountable in an existing troffer fixture
 - Durable steel housing with an acrylic lens that is removable for quick cleaning
 - Suitable for retail, schools, offices, healthcare and other various commercial applications

Troffer Sensor available

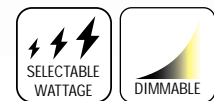

Order Code	Description	Wattage	CCT	Voltage	Color	Function
02651*	LED 2x2 Volumetric Troffer	24W-36W	5000K	100-277V	White	Dimmable

*while supplies last

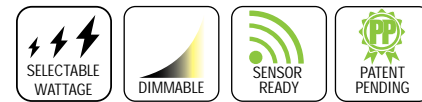

Order Code	Description	Wattage	CCT	Voltage	Color	Function
02656	LED 2x2 Volumetric Troffer	24W-36W	4000K	100-277V	White	Dimmable/SR
02657	LED 2x2 Volumetric Troffer	24W-36W	5000K	100-277V	White	Dimmable/SR
02658	LED 2x4 Volumetric Troffer	24W-36W-42W-50W	4000K	100-277V	White	Dimmable/SR

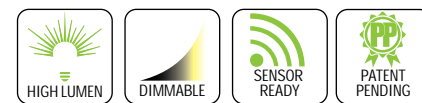

Order Code	Description	Wattage	CCT	Voltage	Color	Function
09167	LED 2x2 Volumetric Troffer	24W-36W	4000K	100-277V	White	HL / Dimmable / SR
09168	LED 2x2 Volumetric Troffer	24W-36W	5000K	100-277V	White	HL / Dimmable / SR
09169	LED 2x4 Volumetric Troffer	24W-36W-42W-50W	4000K	100-277V	White	HL / Dimmable / SR
09170	LED 2x4 Volumetric Troffer	24W-36W-42W-50W	5000K	100-277V	White	HL / Dimmable / SR

Available End of June 2021!

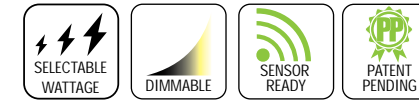

Troffer Sensor available for this model

Order Code	Description	Wattage	CCT	Voltage	Color	Function
02669	LED 2x2 Volumetric Troffer (Sycamore SSR)	24W-36W	4000K	100-277V	White	Dimmable
02670	LED 2x2 Volumetric Troffer (Sycamore SSR)	24W-36W	5000K	100-277V	White	Dimmable
02671	LED 2x4 Volumetric Troffer (Sycamore SSR)	24W-36W-42W	4000K	100-277V	White	Dimmable
02672	LED 2x4 Volumetric Troffer (Sycamore SSR)	24W-36W-42W	5000K	100-277V	White	Dimmable

LIGHTING CONTROLS

Order Code	Description	Height	Voltage	Color	Version	Function
06210	3-in-1 Microwave Fixture Embedded w/ Detachable Sensor (Compatible with 02650, 02651, 02654)	19ft	120-277V	White	Standard	3-in-1
06230	DC Powered 3 in 1 Microwave Control For Sensor Ready Troffer (Compatible with 02656, 02657, 02658, 02659, 09167, 09168, 09169, 09170)	19ft	10-15 VDC	White	Sensor Ready	3-in-1
06258	DC Powered 3 in 1 PIR Control for Sensor Ready Magnetic Strips and Flat Panels (Compatible with 02669, 02670, 02671 and 02672 only)	19ft	10-15 VDC	White	Sensor Ready	3-in-1
06278	LED Intelligent Remote Control	-	-	White	Standard	LCD Display





Sensor Ready

LED BACKLIT THIN PANEL

Description: High output flicker free LED panel light ideal for drop ceilings and easy to surface or suspension mount with optional kits (sold separately). Direct backlit design provides a smooth and more uniform light distribution than edge-lit panels. This series of LED drop ceiling light panels is our most common replacement for 2x4 drop ceiling grids where conventional fluorescent troffers are commonly used. Remote driver enclosure with multiple knockouts for easy access. Quiet & flicker-free LED technology.

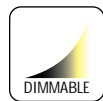

Order Code	Description	Wattage	CCT	Voltage	Color	Function
02801*	LED 2x2 BackLit Thin Panel	30W	3000K	100-277V	White	Dimmable
02817*	LED 2x2 BackLit Thin Panel	30W	5000K	100-277V	White	Dimmable
02804*	LED 2x2 BackLit Thin Panel	30W	6000K	100-277V	White	Dimmable
02820*	LED 2x4 BackLit Thin Panel	40W	3000K	100-277V	White	Dimmable

*while supplies last



Order Code	Description	Wattage	CCT	Voltage	Color	Function
02825	LED 2x2 BackLit Thin Panel	20W-30W-40W	4000K	100-277V	White	Dimmable/SR
02826	LED 2x2 BackLit Thin Panel	20W-30W-40W	5000K	100-277V	White	Dimmable/SR
02821	LED 2x4 BackLit Thin Panel	30W-40W-50W	4000K	100-277V	White	Dimmable/SR
02822	LED 2x4 BackLit Thin Panel	30W-40W-50W	5000K	100-277V	White	Dimmable/SR



Order Code	Description	Wattage	CCT	Voltage	Color	Function
02830	LED 2x2 BackLit Thin Panel (Birch SSR)	15W-20W-30W	4000K	100-277V	White	Dimmable/SR
02831	LED 2x2 BackLit Thin Panel (Birch SSR)	15W-20W-30W	5000K	100-277V	White	Dimmable/SR
02832	LED 2x4 BackLit Thin Panel (Birch SSR)	23W-30W-40W	4000K	100-277V	White	Dimmable/SR
02833	LED 2x4 BackLit Thin Panel (Birch SSR)	23W-30W-40W	5000K	100-277V	White	Dimmable/SR

LED BACKLIT THIN PANEL (BIRCH SSR)

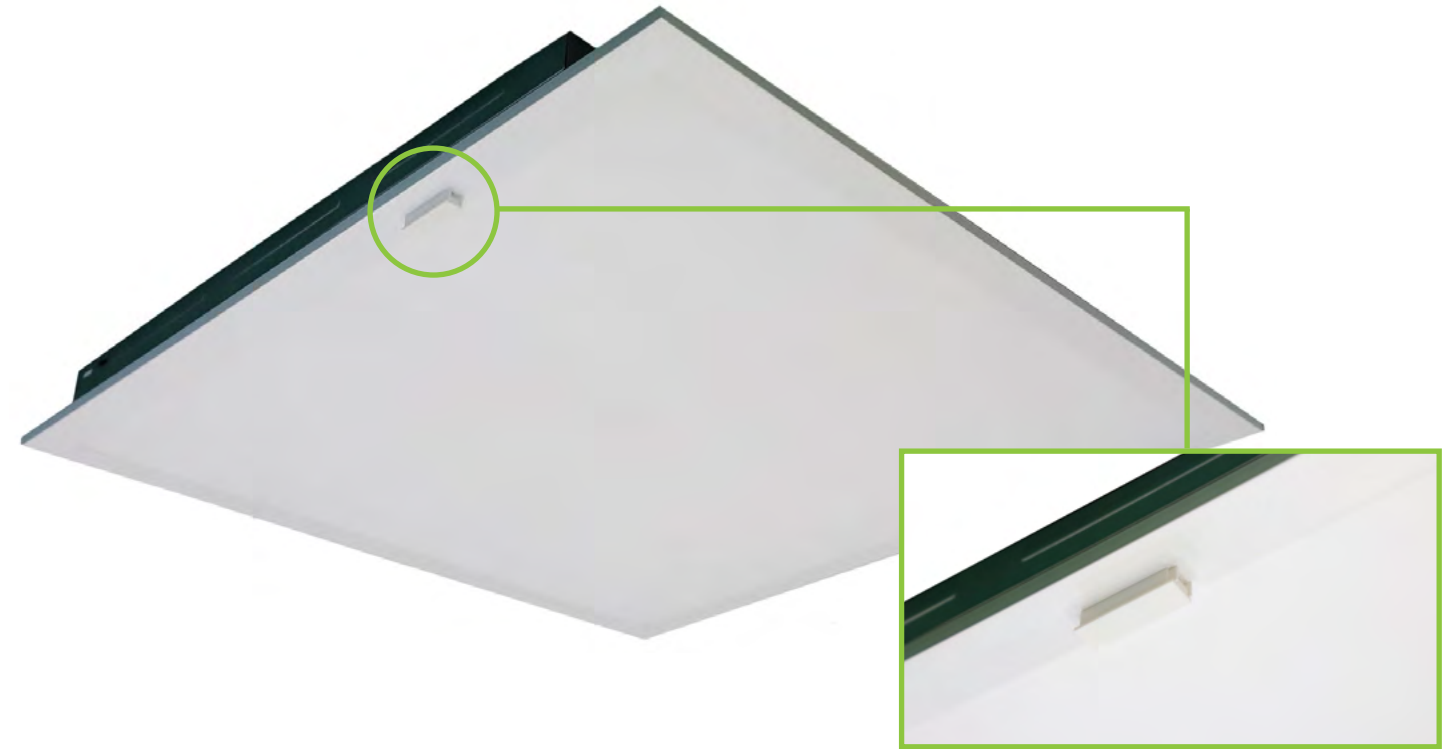

Sensor Ready

ACCESSORIES

Order Code	Description
02888	2x2 Flat Panel - Surface Mount Brackets
02889	2x4 Flat Panel - Surface Mount Brackets
02884	2x2 Recessed Flange For Drywall Ceilings
02885	2x4 Recessed Flange Set for Drywall Ceilings
02886	Aircraft Cable (Universal Yoke and Toggle Suspension Kit)

LIGHTING CONTROLS

Order Code	Description	Height	Voltage	Color	Version	Function
06210	3-in-1 Microwave Fixture Embedded w/ Detachable Sensor	19ft	120-277V	White	Standard	3-in-1
06243	DC Powered 3 in 1 Microwave Control for Sensor Ready Magnetic Strips and Flat Panels	19ft	10-15 VDC	White	Sensor Ready	3-in-1*
06254	LED PIR Fixture Mounted Control 3 in 1 For Troffer	19ft	120-347V	White	Standard	3-in-1
06278	LED Intelligent Remote Control	-	-	White	Standard	LCD Display



LED DOWNLIGHT (CEDAR G)

Description:
Our 4", 6", 8" and 10" LED commercial downlights are wattage selectable, CCT tunable and can be programmed with a toggle switch, allowing the ability to choose multiple color temperatures for any setting. Designed to meet most recessed downlighting application needs. This downlight offers comfortable, diffused lighting, with quiet & flicker-free LED technology.

- Features:**
- High-grade aluminum housing
 - Suitable for offices, conference rooms, retail stores, health care facilities

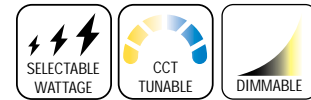

Order Code	Description	Size	Wattage	CCT	Voltage	CRI	Color	Function
02920	LED Downlight	4"	6W-7.5W-11.5W	3000K-3500K-4000K	100-277V	>90	White	Dimmable
02922	LED Downlight	8"	15W-23W-30W	3000K-3500K-4000K	100-277V	>90	White	Dimmable
02923	LED Downlight	8"	37W-42W-50W	3000K-3500K-4000K	100-277V	>90	White	Dimmable
02925	LED Downlight	4"	6W-7.5W-11.5W	3500K-4000K-5000K	100-277V	>90	White	Dimmable
02926	LED Downlight	6"	15W-23W-30W	3500K-4000K-5000K	100-277V	>90	White	Dimmable
02927	LED Downlight	8"	15W-23W-30W	3500K-4000K-5000K	100-277V	>90	White	Dimmable
02929	LED Downlight	10"	37W-42W-50W	3500K-4000K-5000K	100-277V	>90	White	Dimmable



LED DOWNLIGHT (WILLOW G)

Description:
Our 4", 6", 8" and 10" LED commercial downlights are wattage selectable, CCT tunable and can be programmed with a toggle switch, allowing the ability to choose multiple color temperatures for any setting. Designed to meet most recessed downlighting application needs. This downlight offers comfortable, diffused lighting, with quiet & flicker-free LED technology.

- Features:**
- High-grade aluminum housing
 - Suitable for offices, conference rooms, retail stores, health care facilities



Order Code	Description	Size	Wattage	CCT	Voltage	CRI	Color	Function
------------	-------------	------	---------	-----	---------	-----	-------	----------

CRI > 80

02930	LED Downlight	4"	6W-8W-12W	3000K-4000K-5000K	120-277V	>80	White	Dimmable
02931	LED Downlight	6"	8W-12W-16W	3000K-3500K-4000K	120-277V	>80	White	Dimmable
02932	LED Downlight	6"	8W-12W-16W	3000K-4000K-5000K	120-277V	>80	White	Dimmable
02933	LED Downlight	8"	12W-16W-22W	3000K-3500K-4000K	120-277V	>80	White	Dimmable
02934	LED Downlight	8"	12W-16W-22W	3000K-4000K-5000K	120-277V	>80	White	Dimmable
02935	LED Downlight	10"	22W-28W-33W	3000K-3500K-4000K	120-277V	>80	White	Dimmable
02936	LED Downlight	10"	22W-28W-33W	3000K-4000K-5000K	120-277V	>80	White	Dimmable

CRI > 90

02938	LED Downlight	4"	6W-8W-12W	3000K-4000K-5000K	120-277V	>90	White	Dimmable
02939	LED Downlight	6"	8W-12W-16W	3000K-3500K-4000K	120-277V	>90	White	Dimmable
02940	LED Downlight	6"	8W-12W-16W	3000K-4000K-5000K	120-277V	>90	White	Dimmable
02941	LED Downlight	8"	12W-16W-22W	3000K-3500K-4000K	120-277V	>90	White	Dimmable
02942	LED Downlight	8"	12W-16W-22W	3000K-4000K-5000K	120-277V	>90	White	Dimmable
02943	LED Downlight	10"	22W-28W-33W	3000K-3500K-4000K	120-277V	>90	White	Dimmable
02944	LED Downlight	10"	22W-28W-33W	3000K-4000K-5000K	120-277V	>90	White	Dimmable

LIGHTING CONTROLS

Order Code	Description	Height	Voltage	Color	Version	Function
06210	3-in-1 Microwave Fixture Embedded w/ Detachable Sensor	19ft	120-277V	White	Standard	3-in-1
06278	LED Intelligent Remote Control	-	-	White	Standard	LCD Display

LIGHTING CONTROLS

Order Code	Description	Height	Voltage	Color	Version	Function
06210	3-in-1 Microwave Fixture Embedded w/ Detachable Sensor	19ft	120-277V	White	Standard	3-in-1
06278	LED Intelligent Remote Control	-	-	White	Standard	LCD Display



LED ARCHITECTURAL LINEAR STRIP LIGHT

Description:
This sleek, stylish light features up and down lighting, making this a highly effective lighting solution. These 4-foot LED direct/indirect suspended linear fixtures can be linked together are ideal for a variety of indoor and architectural applications where continuous linear lighting is desired. It is suitable for suspended mounting and can be used in continuous rows.

- Features:**
- Steel housing and acrylic lens
 - Suitable for hospitals, offices, schools, stores

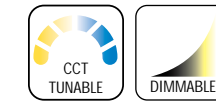

Order Code	Description	Wattage	CCT	Voltage	Color	Function
02550	LED 4ft Linear Strip Light	40W	3000K-4000K-5000K	100-277V	Silver	Linkable - Dimmable
02551	LED 4ft Linear Strip Light	40W	3000K-4000K-5000K	100-277V	White	Linkable - Dimmable
02552	LED 4ft Linear Strip Light	40W	3000K-4000K-5000K	100-277V	Black	Linkable - Dimmable
02553	LED 4ft Linear Strip Light	Up 15W /Down 35W	3000K-4000K-5000K	100-277V	Silver	Linkable - Dimmable
02554	LED 4ft Linear Strip Light	Up 15W /Down 35W	3000K-4000K-5000K	100-277V	White	Linkable - Dimmable
02555	LED 4ft Linear Strip Light	Up 15W /Down 35W	3000K-4000K-5000K	100-277V	Black	Linkable - Dimmable

LIGHTING CONTROLS

Order Code	Description	Height	Voltage	Color	Version	Function
06210	3-in-1 Microwave Fixture Embedded w/ Detachable Sensor	19ft	120-277V	White	Standard	3-in-1
06278	LED Intelligent Remote Control	-	-	White	Standard	LCD Display



LED ROUND HIGH BAY (ASH SSR)

Description:
 These sensor ready LED Round High Bay are the energy efficient, cost saving alternative to a traditional metal halide lights. These commercial low-profile high bay fixtures provide a quick and easy solution for warehouse and industrial applications. The low-profile height allows for efficient packaging, as well as accommodates applications where a low hanging fixture is undesirable.

- Features:**
- Heavy duty cast aluminum with an integrated thermally efficient heatsink profile
 - Suitable for garage, gymnasium, parking garage, workshop
 - Comes with 6ft cord



Order Code	Description	Wattage	CCT	Voltage	Lens	Color	Function
09120	LED Round High Bay	100W	5000K	100-277V	Clear	Black	Dimmable/SR
09121	LED Round High Bay	150W	5000K	100-277V	Clear	Black	Dimmable/SR
09214	LED Round High Bay	200W	5000K	100-277V	Clear	Black	Dimmable/SR



Order Code	Description	Wattage	CCT	Voltage	Lens	Color	Function
03065	LED Round High Bay (Ash SSR)	60W-80W-100W	5000K	100-277V	Clear	Black	Dimmable / Z10 SR / 6KV
03066	LED Round High Bay (Ash SSR)	110W-130W-150W	5000K	100-277V	Clear	Black	Dimmable / Z10 SR / 6KV
03067	LED Round High Bay (Ash SSR)	165W-180W-200W	5000K	100-277V	Clear	Black	Dimmable / Z10 SR / 6KV
03068	LED Round High Bay (Ash SSR)	200W-220W-240W	5000K	200-480V	Clear	Black	Dimmable / Z10 SR / 6KV
03069	LED Round High Bay (Ash SSR)	110W-135W-150W	5000K	200-480V	Clear	Black	Dimmable / Z10 SR / 6KV
03070	LED Round High Bay (Ash SSR)	165W-180W-200W	5000K	200-480V	Clear	Black	Dimmable / Z10 SR / 6KV

ACCESSORIES

Order Code	Description	Wattage
03160	UFO High Bay Acrylic Reflector	-
03161	UFO High Bay Yoke Mount	100-150W
03162	UFO High Bay Wire Guard	200W



LIGHTING CONTROLS

Order Code	Description	Height	Voltage	Color	Version	Function
06234	DC Powered 3-in-1 Microwave Sensor for Sensor Ready Round High Bay	49ft	10-15 VDC	Black	Sensor Ready	3-in-1
06251	DC Powered 3 in 1 Sensor for Outdoor Fixtures	49ft	120-277V	Black	Standard	3-in-1
06278	LED Intelligent Remote Control	-	-	White	Standard	LCD Display



LED LINEAR HIGH BAY FULL BODY (MAPLE B)

Description:
This high bay fixture provides a quick and easy solution for warehouse and industrial applications. The linear profile allows for a one-for-one substitution with existing linear fluorescent high bay fixtures and is designed to replace traditional 150W-1000W T8 fluorescent-equivalent high bay fixtures.

- Features:**
- Extruded aluminum with polycarbonate frosted lens
 - Suitable for factory, workshop, warehouse, gymnasium



Order Code	Description	Wattage	CCT	Voltage	Lens	Color	Function
03350	LED Linear High Bay Full Body	65W	5000K	100-277V	Frosted	White w/V-Hook & Chain	Dimmable
03357	LED Linear High Bay Full Body	85W	5000K	100-277V	Frosted	White w/V-Hook & Chain	Dimmable
03358	LED Linear High Bay Full Body	105W	5000K	100-277V	Frosted	White w/V-Hook & Chain	Dimmable
03359	LED Linear High Bay Full Body	130W	5000K	100-277V	Frosted	White w/V-Hook & Chain	Dimmable
03360	LED Linear High Bay Full Body	155W	5000K	100-277V	Frosted	White w/V-Hook & Chain	Dimmable
03361	LED Linear High Bay Full Body	210W	5000K	100-277V	Frosted	White w/V-Hook & Chain	Dimmable
03362	LED Linear High Bay Full Body	255W	5000K	100-277V	Frosted	White w/V-Hook & Chain	Dimmable



LED LINEAR HIGH BAY STRIP BODY

Description:
These commercial 2ft & 4ft linear high bay fixtures provide a quick and easy solution for warehouse and industrial applications. The linear profile allows for a one-for-one substitution with existing linear fluorescent high bay fixtures where the original chain suspension hardware can transfer directly over for an easy quick install.

- Features:**
- Heavy duty cast aluminum with an integrated thermally efficient heatsink profile
 - Suitable for garage, gymnasium, parking garage, workshop
 - Comes with 6ft cord



Order Code	Description	Wattage	CCT	Voltage	Color	Lens	Function
03555*	LED Strip Body High Bay	90W	5000K	100-277V	White**	Frosted	Dimmable
03553*	LED Strip Body High Bay	220W	5000K	100-277V	White**	Frosted	Dimmable
09148	LED Strip Body High Bay	50W	5000K	100-277V	White***	Frosted	Dimmable
09149	LED Strip Body High Bay	90W	5000K	100-277V	White***	Frosted	Dimmable
09150	LED Strip Body High Bay	110W	5000K	100-277V	White***	Frosted	Dimmable
09151	LED Strip Body High Bay	135W	5000K	100-277V	White***	Frosted	Dimmable
09152	LED Strip Body High Bay	165W	5000K	100-277V	White***	Frosted	Dimmable
09227	LED Strip Body High Bay	220W	5000K	100-277V	White***	Frosted	Dimmable
09228	LED Strip Body High Bay	300W	5000K	100-277V	White***	Frosted	Dimmable

*while supplies last **Aircraft cable included ***Aircraft cable & 6ft cord included

LIGHTING CONTROLS

Order Code	Description	Height	Voltage	Color	Version	Function
06221	LED Microwave Fixture Mounted Sensor	19ft	120-277V	White	Standard	3-in-1
06225	LED Microwave Fixture Mounted Sensor	49ft	347-480V	White	Standard	3-in-1
06245	LED PIR Fixture Mounted Sensor	19ft	120-347V	White	Type D	3-in-1
06246	LED PIR Fixture Mounted Sensor	39ft	120-347V	White	Type D	3-in-1
06247	LED PIR Fixture Mounted Sensor	39ft	120-347V	White	Type D	Simple On/Off
06278	LED Intelligent Remote Control	-	-	White	Standard	LCD Display

ACCESSORIES

Order Code	Description	Wattage
03494	Linear Strip Body High Bay Pendant Mount	90W-220W
03495	Linear Strip Body High Bay Wireguard	90W-165W

LIGHTING CONTROLS

Order Code	Description	Height	Voltage	Color	Version	Function
06221	LED Microwave Fixture Mounted Sensor	19ft	120-277V	White	Standard	3-in-1
06225	LED Microwave Fixture Mounted Sensor	49ft	347-480V	White	Standard	3-in-1
06245	LED PIR Fixture Mounted Sensor	19ft	120-347V	White	Type D	3-in-1
06246	LED PIR Fixture Mounted Sensor	39ft	120-347V	White	Type D	3-in-1
06247	LED PIR Fixture Mounted Sensor	39ft	120-347V	White	Type D	Simple On/Off
06278	LED Intelligent Remote Control	-	-	White	Standard	LCD Display

Available End of June 2021!

LED LINEAR HIGH BAY STRIP BODY (PINE SSR)



Description:

These commercial 2ft & 4ft linear high bay fixtures provide a quick and easy solution for warehouse and industrial applications. The linear profile allows for a one-for-one substitution with existing linear fluorescent high bay fixtures where the original chain suspension hardware can transfer directly over for an easy quick install.

Features:

- Heavy duty cast aluminum with an integrated thermally efficient heatsink profile
- Suitable for garage, gymnasium, parking garage, workshop
- Comes with 6ft cord



Order Code	Description	Size	Wattage	CCT	Voltage	Lens	Color	Function
09240	LED Strip Body High Bay (Pine SSR)	2ft	70W-90W-110W	5000K	100-277V	Frosted	White w/Aircraft Cable & 6ft Cord	Dimmable / Z10 SR / 10KV
09241	LED Strip Body High Bay (Pine SSR)	2ft	135W-150W-165W	5000K	100-277V	Frosted	White w/Aircraft Cable & 6ft Cord	Dimmable / Z10 SR / 10KV
09242	LED Strip Body High Bay (Pine SSR)	2ft	180W-200W-220W	5000K	100-277V	Frosted	White w/Aircraft Cable & 6ft Cord	Dimmable / Z10 SR / 10KV
09243	LED Strip Body High Bay (Pine SSR)	3ft	180W-200W-220W	5000K	100-277V	Frosted	White w/Aircraft Cable & 6ft Cord	Dimmable / Z10 SR / 10KV
09244	LED Strip Body High Bay (Pine SSR)	3ft	255W-275W-300W	5000K	100-277V	Frosted	White w/Aircraft Cable & 6ft Cord	Dimmable / Z10 SR / 10KV

ACCESSORIES

Order Code	Description	Wattage
03494	Linear Strip Body High Bay Pendant Mount	90W-220W
03497	3FT Linear Strip Body High Bay Pendant Mount	220W-300W
03498	3FT Linear Strip Body High Bay Wireguard	220W-300W

LIGHTING CONTROLS

Order Code	Description	Height	Voltage	Color	Version	Function
06221	LED Microwave Fixture Mounted Sensor	19ft	120-277V	White	Standard	3-in-1
06225	LED Microwave Fixture Mounted Sensor	49ft	347-480V	White	Standard	3-in-1
06245	LED PIR Fixture Mounted Sensor	19ft	120-347V	White	Type D	3-in-1
06246	LED PIR Fixture Mounted Sensor	39ft	120-347V	White	Type D	3-in-1
06247	LED PIR Fixture Mounted Sensor	39ft	120-347V	White	Type D	Simple On/Off
06278	LED Intelligent Remote Control	-	-	White	Standard	LCD Display



LED LINEAR SKY BAY

Description:

MES LED Sky Bay high bay lighting fixture is ideally suited for warehouses, manufacturing plants, sports facilities and retail spaces with regular to higher than normal ceilings. High efficiency LED illumination engineered for premium performance in higher than normal to medium high ceilings. Precision-formed mirrored reflector achieves maximum light output for ceilings from 15' to 40'. The LED Sky Bay high bay replaces expensive to operate, old fashioned fluorescent and HID high bays using half of the wattage. Mounting choice includes chain.

Features:

- Extruded aluminum with polycarbonate frosted lens
- Suitable for factory, workshop, warehouse, gymnasium

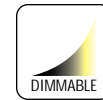

Order Code	Description	Wattage	CCT	Voltage	Color	Lens	Function
03202*	LED Linear Sky Bay	100W	5000K	100-277V	Silver w/Hook & Chain	Clear	Dimmable
03203*	LED Linear Sky Bay	100W	5000K	100-277V	Silver w/Hook & Chain	Frosted	Dimmable
03204*	LED Linear Sky Bay	150W	5000K	100-277V	Silver w/Hook & Chain	Clear	Dimmable
03205*	LED Linear Sky Bay	150W	5000K	100-277V	Silver w/Hook & Chain	Frosted	Dimmable
03207*	LED Linear Sky Bay	200W	5000K	100-277V	Silver w/Hook & Chain	Frosted	Dimmable

*while supplies last

LIGHTING CONTROLS

Order Code	Description	Height	Voltage	Color	Version	Function
06221	LED Microwave Fixture Mounted Sensor	19ft	120-277V	White	Standard	3-in-1
06225	LED Microwave Fixture Mounted Sensor	49ft	347-480V	White	Standard	3-in-1
06245	LED PIR Fixture Mounted Sensor	19ft	120-347V	White	Type D	3-in-1
06246	LED PIR Fixture Mounted Sensor	39ft	120-347V	White	Type D	3-in-1
06247	LED PIR Fixture Mounted Sensor	39ft	120-347V	White	Type D	Simple On/Off
06278	LED Intelligent Remote Control	-	-	White	Standard	LCD Display

REMEMBER

MES OPTIONAL 10 YEAR WARRANTY



MES products come standard with a best-in-class 7-year warranty. For an additional peace of mind, remember to request our optional 10-year product warranty or 10-year warranty for product and labor.

See your sales representative for additional details.



LED SECURITY WALL PACK

Description:
The Security Wall Pack is a great addition to poorly lit areas. This fixture can be mounted directly to a wall, side of building, or above a walkway. Construction consists of a weatherproof powder coated aluminum housing with wiring and conduit knockouts and a polycarbonate lens. Easily mount the wall pack on a recessed junction box. With its built in photocell, this fixture turns on automatically when the environment gets dark and turns off by itself with the first glimpse of daylight.

- Features:**
- Die-cast aluminum with prismatic polycarbonate lens
 - Suitable for security lighting, perimeter lighting, parking garage



Order Code	Description	Wattage	CCT	Voltage	Color	Function
05050	LED Wall Pack Security	15W	5000K	120V	Bronze	Photocell
05051	LED Wall Pack Security	15W	5000K	120V	White	Photocell
05052	LED Wall Pack Security	20W	5000K	120V	Bronze	Photocell
05053	LED Wall Pack Security	20W	5000K	120V	White	Photocell



LED STANDARD WALL PACK

Description:

The LED standard wall pack combines traditional wall pack design with high-output LEDs to provide an energy-efficient, low maintenance LED wall pack suitable for replacing Metal Halide fixtures. The traditional shape helps maintain building aesthetics when replacing only a portion of your building's wall packs at a time while also eliminating unwanted markings from the removal of older fixtures.

Features:

- Die-cast aluminum housing with hinged door frame
- Suitable for warehouse, factory, storage, pedestrian lighting



Order Code	Description	Wattage	CCT	Voltage	Color	Function
05232*	LED Standard Wall Pack	35W	5000K	100-277V	White	-
05235*	LED Standard Wall Pack	55W	5000K	100-277V	White	-
05244*	LED Standard Wall Pack	120W	5000K	100-277V	White	-
05245	LED Standard Wall Pack	35W	5000K	100-277V	Bronze	Photocell
09100	LED Standard Wall Pack	55W	5000K	100-277V	Bronze	Photocell
05248	LED Standard Wall Pack	80W	5000K	100-277V	Bronze	Photocell
09101	LED Standard Wall Pack	120W	5000K	100-277V	Bronze	Photocell
09102	LED Standard Wall Pack	35W	5000K	100-277V	White	Photocell
09103	LED Standard Wall Pack	55W	5000K	100-277V	White	Photocell
09104	LED Standard Wall Pack	80W	5000K	100-277V	White	Photocell

*while supplies last



Order Code	Description	Wattage	CCT	Voltage	Color	Function
05246	LED Standard Wall Pack	40W	3000K-4000K-5000K	100-277V	Bronze	Photocell
05247	LED Standard Wall Pack	60W	3000K-4000K-5000K	100-277V	Bronze	Photocell
05249	LED Standard Wall Pack	80W	3000K-4000K-5000K	100-277V	Bronze	Photocell

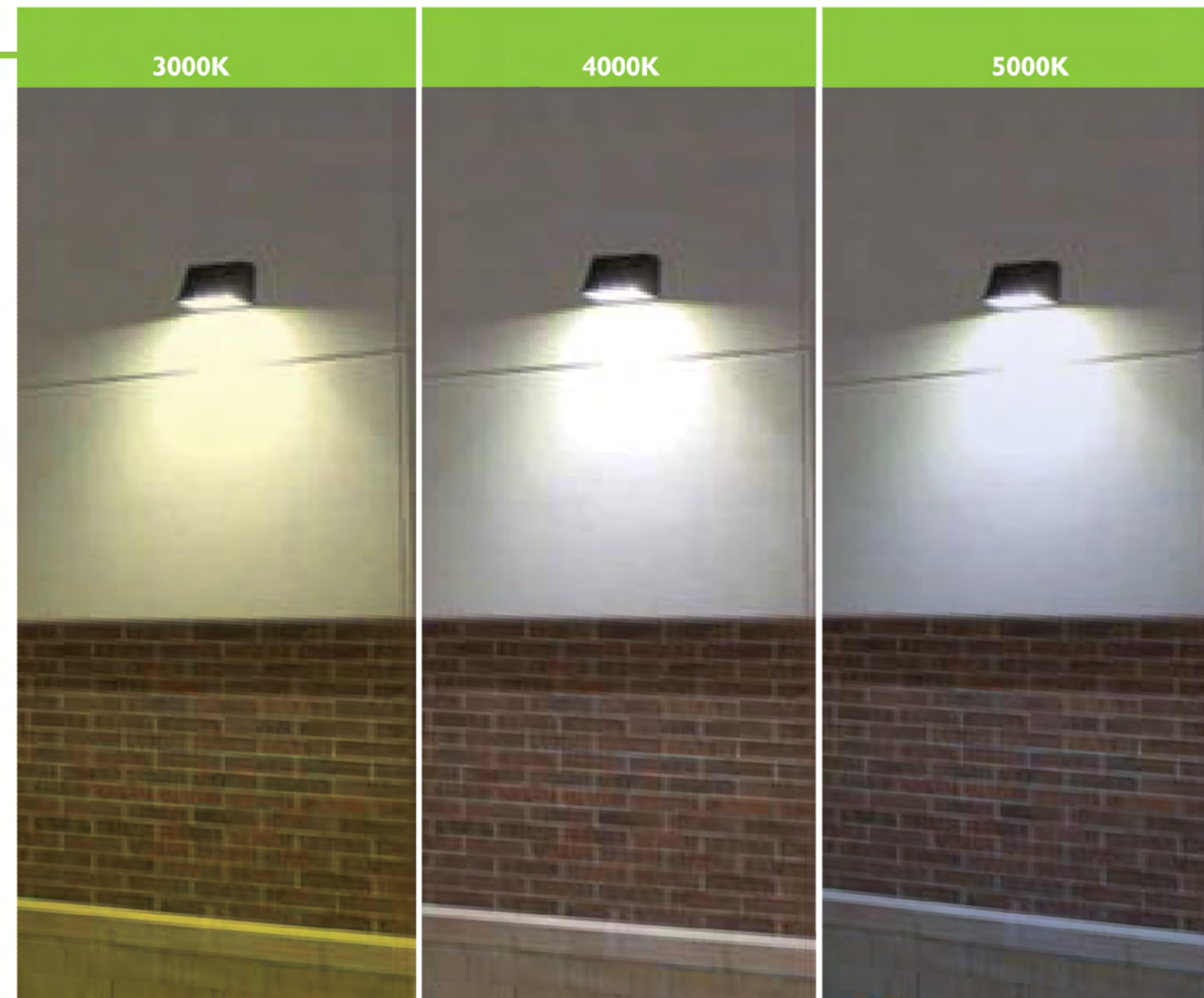

ACCESSORIES

Order Code	Description	Voltage
05290	Standard Wall Pack Shield Cover	-
08361	Step Down Transformer	200-480V to 100-277V



LED FULL CUT OFF WALL PACK

Description:

- This selectable wattage LED Full Cutoff Wall Pack features a rugged exterior housing, ideal for commercial outdoor buildings and easily replaces any preexisting wall pack fixture.

Features:

- Die-cast aluminum housing with die-cast aluminum with polycarbonate lens
- Surface mounted, suitable for hospitals warehouses, factories, storage, retail



Order Code	Description	Wattage	CCT	Voltage	Color	Function
05123	LED Full Cutoff Wall Pack	20W-30W-40W	5000K	100-277V	Bronze	PIR SR
05124	LED Full Cutoff Wall Pack	20W-40W-60W-80W	5000K	100-277V	Bronze	PIR SR



Order Code	Description	Wattage	CCT	Voltage	Color	Function
05125	LED Full Cutoff Wall Pack	20W-30W-40W	3000K 4000K 5000K	100-277V	Bronze	PIR SR

ACCESSORIES

Order Code	Description	Voltage
08361	Step Down Transformer	200-480V to 100-277V

LIGHTING CONTROLS

Order Code	Description	Height	Voltage	Color	Version	Function
06251	DC Powered 3 in 1 Sensor for Outdoor Fixtures	49ft	120-277V	Black	Standard	3-in-1

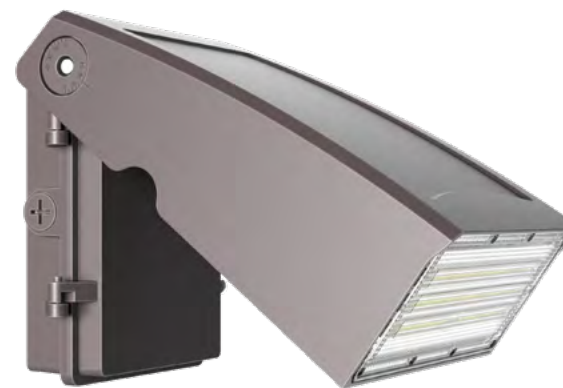

LED SLIM FULL CUTOFF

Description:

This LED Slim Full Cutoff Wall Pack comes with selectable wattage and is PIR sensor ready, adjustable from 0-90 degree angles and ideal for ideal for commercial outdoor buildings. It easily replaces any pre-existing wall pack fixture.

Features:

- Die-cast aluminum housing with prismatic lens
- Suitable for warehouse, factory, storage, pedestrian lighting



Order Code	Description	Wattage	CCT	Voltage	Color	Function
05108	LED Slim Full Cutoff Wall Pack	20W-30W-40W	5000K	100-277V	Bronze	PIR SR
05109	LED Slim Full Cutoff Wall Pack	20W-40W-60W-80W	5000K	100-277V	Bronze	PIR SR

ACCESSORIES

Order Code	Description	Voltage
08361	Step Down Transformer	200-480V to 100-277V

LIGHTING CONTROLS

Order Code	Description	Height	Voltage	Color	Version	Function
06251	DC Powered 3 in 1 Sensor for Outdoor Fixtures	49ft	120-277V	Black	Standard	3-in-1



LED SMALL FLOOD LIGHT

Description:

The LED Small Flood is a high performance LED lighting solution designed with optical versatility and a slim, low profile design. Its rugged cast aluminum housing minimizes wind load requirements and features an integral, watertight LED driver compartment and high performance aluminum heat sinks.

Features:

- Die-cast aluminum housing with prismatic lens
- Suitable for warehouse, factory, storage, pedestrian lighting



Order Code	Description	Wattage	CCT	Voltage	Color	Mount	Lens
05351	LED Flood Light	15W	5000K	100-277V	Bronze	Yoke Mount	Type 5 Lens
05353	LED Flood Light	30W	5000K	100-277V	Bronze	Knuckle Mount	Type 5 Lens
05354	LED Flood Light	30W	5000K	100-277V	Bronze	Trunnion Mount	Type 5 Lens
05355*	LED Flood Light	30W	5000K	100-277V	Bronze	Yoke Mount	Type 5 Lens
05356	LED Flood Light	50W	5000K	100-277V	Bronze	Knuckle Mount	Type 5 Lens
05357*	LED Flood Light	50W	5000K	100-277V	Bronze	Yoke Mount	Type 5 Lens
05358	LED Flood Light	50W	5000K	100-277V	Bronze	Trunnion Mount	Type 5 Lens

*while supplies last



Order Code	Description	Wattage	CCT	Voltage	Color	Mount	Lens
05359	LED Flood Light	30W	3000K-4000K-5000K	100-277V	Bronze	Knuckle Mount	Type 5 Lens
05360	LED Flood Light	30W	3000K-4000K-5000K	100-277V	Bronze	Trunnion Mount	Type 5 Lens
05361	LED Flood Light	50W	3000K-4000K-5000K	100-277V	Bronze	Knuckle Mount	Type 5 Lens
05362	LED Flood Light	50W	3000K-4000K-5000K	100-277V	Bronze	Trunnion Mount	Type 5 Lens

ACCESSORIES

Order Code	Description	Height	Voltage	Color	Version	Function
08361	Step Down Transformer	-	200-480V to 100-277V	-	-	-

LIGHTING CONTROLS

Order Code	Description	Height	Voltage	Color	Version	Function
06451	Photocell Button Style	-	120-277V	Black	Standard	Simple On/Off
09172	Photocell Swivel Style	-	120-277V	Black	Standard	Simple On/Off





LED MULTI-PURPOSE FLOOD LIGHT

Description:

Our slim design LED Multi-Purpose Flood is built to withstand all climates and extreme temperatures. Comes standard with trunnion mount, other mounts are listed and sold separately. The easy mount system includes options such as: slipfitter, arm mounts, and trunnion. With a Type V distribution it delivers the widest distribution pattern, excellent for illuminating the inside portions of a parking lot or a 4 way intersection. Use this distribution type for large areas including parking lots and roadways. The integrated Meanwell driver supplies quality, energy saving lighting compared to HID area lights.

Features:

- Die-cast aluminum housing with powder coat finish. UV-stabilized polycarbonate lens
- Suitable for building, parking lots, parking poles, retail, street lights



1. Select light

2. Select mount

Order Code	Description	Wattage	CCT	Voltage	Color	Lens	Mount	Function
05495*	LED Multi Purpose Flood Light	150W	5000K	100-277V	Bronze	Type 5 Lens	Trunnion Mount	-
05496*	LED Multi Purpose Flood Light	240W	5000K	100-277V	Bronze	Type 5 Lens	Trunnion Mount	-
05503*	LED Multi Purpose Flood Light	150W	5000K	100-277V	Bronze	Type 5 Lens	Trunnion Mount	Photocell Ready
05505*	LED Multi Purpose Flood Light	200W	5000K	100-277V	Bronze	Type 5 Lens	Trunnion Mount	Photocell Ready
05506*	LED Multi Purpose Flood Light	240W	5000K	100-277V	Bronze	Type 5 Lens	Trunnion Mount	Photocell Ready
05508*	LED Multi Purpose Flood Light	300W	5000K	100-277V	Bronze	Type 5 Lens	Trunnion Mount	Photocell Ready
05502*	LED Multi Purpose Flood Light	100W	5000K	200-480V	Bronze	Type 5 Lens	Trunnion Mount	Photocell Ready
05504*	LED Multi Purpose Flood Light	150W	5000K	200-480V	Bronze	Type 5 Lens	Trunnion Mount	Photocell Ready
05507*	LED Multi Purpose Flood Light	240W	5000K	200-480V	Bronze	Type 5 Lens	Trunnion Mount	Photocell Ready

*while supplies last

ACCESSORIES

Order Code	Description	Voltage
08361	Step Down Transformer	200-480V to 100-277V

LIGHTING CONTROLS

Order Code	Description	Height	Voltage	Color	Version	Function
05714	Twist Lock Photocell for Shoebox & Multi- Purpose Flood	-	100-277V	Blue	Standard	Simple On/Off
05715	Twist Lock Photocell for Shoebox & Multi-Purpose Flood	-	200-480V	Yellow	Standard	Simple On/Off

MULTI-PURPOSE FLOOD LIGHT MOUNT OPTIONS



Arm Mount



Slipfitter Mount
80W-150W



Slipfitter Mount
185W-300W



Trunnion Mount

MOUNTS

Order Code	Description	Wattage	Color
05570	Multi Purpose Flood Fixture Arm Mount	-	Bronze
05572	Multi Purpose Flood Fixture Slipfitter Mount	80-150W	Bronze
05573	Multi Purpose Flood Fixture Slipfitter Mount	185-300W	Bronze
05575	Multi Purpose Flood Fixture Trunnion Mount	-	Bronze





LED SHOEBOX LIGHT (GEN 4)

Description:

Our slim design LED Shoebox light is built to withstand all climates and extreme temperatures. The easy mount system includes your choice of slipfitter, arm mount, or trunnion mount. With a Type III distribution it delivers an oval light with a lateral width of 40 degrees that projects outwards into the area being lit. Use this distribution type for large areas including parking lots and roadways. The integrated Mean Well driver supplies quality, energy saving lighting compared to HID area lights.

Features:

- Die cast aluminum with powder coat finish. UV-stabilized polycarbonate lens
- Suitable for retail, parking lot poles, street lights



1. Select light

2. Select mount



Order Code	Description	Wattage	CCT	Voltage	Color	Lens	Function
05673	LED Shoebox Light	90W	5000K	100-277V	Black	Type 3	Photocell Ready
05676	LED Shoebox Light	150W	5000K	100-277V	Black	Type 3	Photocell Ready
05679	LED Shoebox Light	240W	5000K	100-277V	Black	Type 3	Photocell Ready
09105	LED Shoebox Light	60W	5000K	100-277V	Bronze	Type 3	Photocell Ready
05672	LED Shoebox Light	90W	5000K	100-277V	Bronze	Type 3	Photocell Ready
05674	LED Shoebox Light	120W	5000K	100-277V	Bronze	Type 3	Photocell Ready
05675	LED Shoebox Light	150W	5000K	100-277V	Bronze	Type 3	Photocell Ready
05677	LED Shoebox Light	185W	5000K	100-277V	Bronze	Type 3	Photocell Ready
05678	LED Shoebox Light	240W	5000K	100-277V	Bronze	Type 3	Photocell Ready
05680	LED Shoebox Light	300W	5000K	100-277V	Bronze	Type 3	Photocell Ready
09112	LED Shoebox Light	60W	5000K	100-277V	White	Type 3	Photocell Ready
09113	LED Shoebox Light	90W	5000K	100-277V	White	Type 3	Photocell Ready
05654	LED Shoebox Light	120W	5000K	100-277V	White	Type 3	Photocell Ready
05738	LED Shoebox Light	150W	5000K	100-277V	White	Type 3	Photocell Ready
05661	LED Shoebox Light	185W	5000K	100-277V	White	Type 3	Photocell Ready
05742	LED Shoebox Light	200W	5000K	100-277V	White	Type 3	Photocell Ready
09110	LED Shoebox Light	240W	5000K	100-277V	White	Type 3	Photocell Ready
09111	LED Shoebox Light	300W	5000K	100-277V	White	Type 3	Photocell Ready
09106	LED Shoebox Light	150W	5000K	200-480V	Bronze	Type 3	Photocell Ready
09107	LED Shoebox Light	200W	5000K	200-480V	Bronze	Type 3	Photocell Ready
09108	LED Shoebox Light	240W	5000K	200-480V	Bronze	Type 3	Photocell Ready
09109	LED Shoebox Light	300W	5000K	200-480V	Bronze	Type 3	Photocell Ready
05658	LED Shoebox Light	150W	5000K	200-480V	White	Type 3	Photocell Ready
09116	LED Shoebox Light	240W	5000K	200-480V	White	Type 3	Photocell Ready
09117	LED Shoebox Light	300W	5000K	200-480V	White	Type 3	Photocell Ready

SHOEBOX LIGHT MOUNT OPTIONS



Arm Mount



Slipfitter Mount



Trunnion Mount

MOUNTS

Order Code	Description	Color
05702	Shoebox Arm Mount	Black
05708	Shoebox Trunnion Mount	Black
05705	Shoebox Slipfitter Mount	Black
05700	Shoebox Arm Mount	Bronze
05703	Shoebox Slipfitter Mount	Bronze
05706	Shoebox Trunnion Mount	Bronze
05701	Shoebox Arm Mount	White
05704	Shoebox Slipfitter Mount	White
05707	Shoebox Trunnion Mount	White

ACCESSORIES

Order Code	Description	Wattage	Voltage
05712	Medium Shield	100-150W	
05713	Large Shield	240-300W	
08361	Step Down Transformer	-	200-480V to 100-277V

LIGHTING CONTROLS

Order Code	Description	Height	Voltage	Color	Version	Function
05714	Twist Lock Photocell for Shoebox & Multi- Purpose Flood	-	100-277V	Blue	Standard	Simple On/Off
05715	Twist Lock Photocell for Shoebox & Multi-Purpose Flood	-	200-480V	Yellow	Standard	Simple On/Off

LED SHOEBOX LIGHT (GEN 5)

Description:

This LED Shoebox Light has slim, low profile design and can be used at parking lot, entrance, walkways, sport courts, highway, pole, roads, streets and recreation areas. With high quality driver and cellular aluminum housing, this fixture offers various optional mounting choices including slipfitter, arm, pole and trunnion mounts. Includes photocell and motion sensor.

Features:

- Die cast aluminum with powder coat finish. UV-stabilized polycarbonate lens
- Suitable for retail, parking lot poles, street lights



1. Select light

2. Select mount

Order Code	Description	Wattage	CCT	Voltage	Color	Mount	Lens	Function
05734	LED Shoebox Light	100W	5000K	100-277V	White	No Mount	Type 3	Photocell Ready
05738	LED Shoebox Light	150W	5000K	100-277V	White	No Mount	Type 3	Photocell Ready
05740	LED Shoebox Light	200W	5000K	100-277V	Bronze	No Mount	Type 3	Photocell Ready
05742	LED Shoebox Light	200W	5000K	100-277V	White	No Mount	Type 3	Photocell Ready
05744	LED Shoebox Light	240W	5000K	100-277V	Bronze	No Mount	Type 3	Photocell Ready

*while supplies last

SHOEBOX LIGHT MOUNT OPTIONS



Arm Mount



Slipfitter Mount



Trunnion Mount

MOUNTS

Order Code	Description	Color
05781	LED Shoebox Arm Mount	Bronze
05784	LED Shoebox Slipfitter Mount	Bronze
05786	LED Shoebox Trunnion Mount	Bronze
05783	LED Shoebox Arm Mount	White
05785	LED Shoebox Slipfitter Mount	White
05787	LED Shoebox Trunnion Mount	White

ACCESSORIES

Order Code	Description	Wattage	Voltage
08361	Step Down Transformer	-	200-480V to 100-277V

LIGHTING CONTROLS

Order Code	Description	Height	Voltage	Color	Version	Function
05714	Twist Lock Photocell for Shoebox & Multi- Purpose Flood	-	100-277V	Blue	Standard	Simple On/Off
05715	Twist Lock Photocell for Shoebox & Multi-Purpose Flood	-	200-480V	Yellow	Standard	Simple On/Off



LED POST TOP LIGHT

Description:

This beautifully designed LED post top light provides a style that can be used for traditional and contemporary applications. Some models offer CCT Tunable functionality, allowing the ability to change the light color temperature from a warm white (3000K) to a natural white (4000K) to a daylight white (5000K), giving this light the capability to fit all application necessities. For convenience, the photocell feature offers a maintenance-free dusk to dawn operation.

Features:

- Powder-coated aluminum, durable exterior, resists corrosion
- CCT Tunable
- Suitable for corporate parks, downtown spaces, or retail parkways



Order Code	Description	Wattage	CCT	Voltage	Color	Function
05902	LED Post Top	100W	5000K	100-277V	Bronze	Photocell Ready
05903	LED Post Top	150W	5000K	100-277V	Bronze	Photocell Ready



Order Code	Description	Wattage	CCT	Voltage	Color	Function
05900	LED Post Top	35W	3000K-4000K-5000K	100-277V	Bronze	Photocell Ready
05901	LED Post Top	55W	3000K-4000K-5000K	100-277V	Bronze	Photocell Ready

LIGHTING CONTROLS

Order Code	Description	Height	Voltage	Color	Version	Function
05714	Twist Lock Photocell for Shoebox & Multi- Purpose Flood	-	100-277V	Blue	Standard	Simple On/Off
05715	Twist Lock Photocell for Shoebox & Multi-Purpose Flood	-	200-480V	Yellow	Standard	Simple On/Off

LED BARN LIGHT

Description:

These LED Barn Lights are great addition to poorly lit areas. This fixture can be mounted directly to a wall, pole, or to a new or existing mounting arm. Built with SMB technology providing up to 6,875 LM, the barn light produces radiant light for your outdoor activities. Its die casting aluminum housing gives great passive heat dissipation, shock, and erosion resistance. With its built in photocell, this fixture turns on automatically when the environment gets dark and turns off by itself with the first glimpse of daylight.

Features:

- Die cast aluminum with prismatic polycarbonate lens
- Suitable for security lighting, perimeter lighting, farm, garage, barn, yard, parkways



Order Code	Product	Wattage	CCT	Voltage	Color	Function
05001	LED Dusk to Dawn Barn Light	35W	5000K	100-277V	Silver Grey	Dimmable
05002	LED Dusk to Dawn Barn Light	55W	5000K	100-277V	Silver Grey	Dimmable

ACCESSORIES

Order Code	Description	Wattage	Voltage
05030	Curve Metal Pipe for Barn Light Only	-	-
08361	Step Down Transformer	-	200-480V to 100-277V

LIGHTING CONTROLS

Order Code	Description	Height	Voltage	Color	Version	Function
05714	Twist Lock Photocell for Shoebox & Multi- Purpose Flood	-	100-277V	Blue	Standard	Simple On/Off
05715	Twist Lock Photocell for Shoebox & Multi-Purpose Flood	-	200-480V	Yellow	Standard	Simple On/Off



LED GARAGE CANOPY LIGHT

Description:

This slim and sleek LED Garage / Canopy Light is a high performance light fixture, capable of being mounted in any soffit/canopy or even surface mounted. Because of its unique design and features, it's the best outdoor lighting fixture applicable to any industrial or commercial premise but most particularly for gas stations. The 160-degree beam angle is perfect for illuminating large spaces without leaving dark spots.

Features:

- Die cast aluminum with prismatic polycarbonate lens
- Suitable for warehouse, factory, gas station, workshop, parking garage



Order Code	Product	Wattage	CCT	Voltage	Color	Function
05812	LED Garage Canopy Light	40W	5000K	100-277V	White	-
05814	LED Garage Canopy Light	75W	5000K	100-277V	White	-

ACCESSORIES

Order Code	Description	Size	Hole	Voltage
05880	Canopy Flat Plate	18x18	8x8 Square Hole	-
05882	Canopy Flat Plate	18x18	-	-
05883	Canopy Flat Plate	24x24	8x8 Square Hole	-
05884	Canopy Flat Plate	24x24	-	-
08361	Step Down Transformer	-	-	200-480V to 100-277V

LIGHTING CONTROLS

Order Code	Description	Height	Voltage	Color	Version	Function
06451	Photocell Button Style	-	120-277V	Black	Standard	Simple On/Off
09172	Photocell Swivel Style	-	120-277V	Black	Standard	Simple On/Off

LED SMALL CANOPY LIGHT

Description:

Our Small Canopy Light is designed with an optical lens distributing more uniform light for various applications. Wattages range from 20W to 80W and offers high luminous efficacy of up to 137 LM/W. This fixture is a perfect replacement for metal halide/high pressure sodium 100~400W lights. The concise and elegant housing features an impressive design, allowing hand-free wiring connection. An optimized thermal management system and drivers maximize this fixture's lifespan.

Features:

- Die-cast aluminum with powder-coated finish and prismatic polycarbonate lens

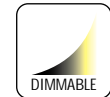

Order Code	Description	Wattage	CCT	Voltage	Color	Function
05871*	LED Canopy Light	30W	5000K	100-277V	Bronze	Dimmable
05872*	LED Canopy Light	40W	5000K	100-277V	Bronze	Dimmable
05873*	LED Canopy Light	80W	5000K	100-277V	Bronze	Dimmable

*while supplies last

ACCESSORIES

Order Code	Description	Size	Hole	Voltage
05880	Canopy Flat Plate	18x18	8x8 Square Hole	-
05882	Canopy Flat Plate	18x18	-	-
05883	Canopy Flat Plate	24x24	8x8 Square Hole	-
05884	Canopy Flat Plate	24x24	-	-
08361	Step Down Transformer	-	-	200-480V to 100-277V

LIGHTING CONTROLS

Order Code	Description	Height	Voltage	Color	Version	Function
06451	Photocell Button Style	-	120-277V	Black	Standard	Simple On/Off
09172	Photocell Swivel Style	-	120-277V	Black	Standard	Simple On/Off



LED PETROLEUM CANOPY LIGHT

Description:

This slim and sleek LED Petroleum Canopy Light is a high-performance light fixture, capable of being mounted in any soffit/canopy or even surface mounted. Because of its unique design and features, it's the best outdoor lighting fixture applicable to any industrial or commercial premise but most particularly for gas stations. The 120-degree beam angle is perfect for illuminating large spaces without leaving dark spots.

Features:

- Die cast aluminum with integral heatsink
- Suitable for warehouse, factory, gas station, workshop



Order Code	Description	Wattage	CCT	Voltage	Color	Function
05853	LED Canopy Light	120W	5000K	100-277V	White	-
05854	LED Canopy Light	150W	5000K	100-277V	White	-

ACCESSORIES

Order Code	Description	Size	Hole	Voltage
05880	Canopy Flat Plate	18x18	8x8 Square Hole	-
05882	Canopy Flat Plate	18x18	-	-
05883	Canopy Flat Plate	24x24	8x8 Square Hole	-
05884	Canopy Flat Plate	24x24	-	-
08361	Step Down Transformer	-	-	200-480V to 100-277V

LIGHTING CONTROLS

Order Code	Description	Height	Voltage	Color	Version	Function
06451	Photocell Button Style	-	120-277V	Black	Standard	Simple On/Off
09172	Photocell Swivel Style	-	120-277V	Black	Standard	Simple On/Off



LED STADIUM LIGHT



Description:

Light up any parking lot or stadium with this high output LED Stadium Light. This energy-saving light has instant start with no flickering or humming. 30 degree beam angle pushes more of the light to the ground. Ideal for higher installs and designed to replace a 1500 watt Metal Halide.

Features:

- Aluminum housing with high tech heat sink.
- IP65 waterproof for all weather conditions
- Suitable for stadium and parking lot lighting



Order Code	Description	Wattage	CCT	Voltage	Color	Lens	Function
05950	LED Stadium Light	500W	5000K	100-277V	Black	Striped	-
09153	LED Stadium Light	500W	5000K	200-480V	Black	Striped	-

ACCESSORIES

Order Code	Description			
05721	Stadium Light Slipfitter Mount			
05723	Stadium Light Laser			

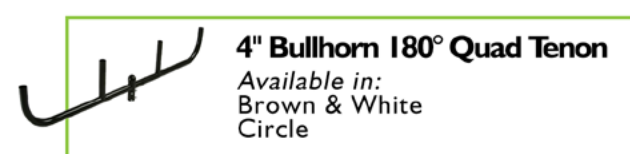
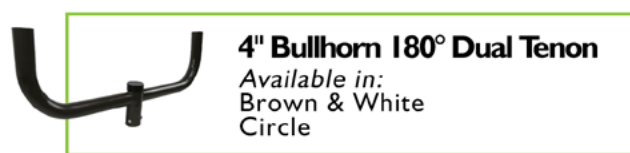

Mounting brackets and accessories for our Shoebox and Multipurpose Flood Lights can be found on pages 55, 57 and 59.

Order Code	Description	Color	Mount Position
01002	Straight Wall Mount Bracket	Bronze	
01003	Straight Wall Mount Bracket	White	
01004	90° Degree Wall Mount Bracket	Bronze	L Bracket
01005	90° Degree Wall Mount Bracket	Black	L Bracket
01006	Side Mount Bracket for Square Pole	Bronze	
01100	4" Square Tenon Adapter	Bronze	Vertical Mount
01101	4" Square Tenon Adapter	White	Vertical Mount
01102	4" Circle Tenon Adapter	Bronze	Vertical Mount
01103	4" Circle Tenon Adapter	White	Vertical Mount
01104	4" Square Short Single Tenon	Bronze	Horizontal
01105	4" Square Short Single Tenon	White	Horizontal
01106	4" Square Short 180° Twin Tenon	Bronze	
01107	4" Square Short 180° Twin Tenon	White	
01108	4" Circle Short 180° Twin Tenon	Bronze	
01109	4" Circle Short 180° Twin Tenon	White	
01110	4" Square Short 90° Twin Tenon	Bronze	
01111	4" Square Short 90° Twin Tenon	White	
01112	4" Circle Short 90° Twin Tenon	Bronze	
01113	4" Circle Short 90° Twin Tenon	White	
01114	4" Square Short 90° Triple Tenon	Bronze	
01115	4" Square Short 90° Triple Tenon	White	
01116	4" Circle Short 90° Triple Tenon	Bronze	
01117	4" Circle Short 90° Triple Tenon	White	
01118	4" Square Short 90° Quad Tenon	Bronze	
01119	4" Square Short 90° Quad Tenon	White	
01120	4" Circle Short 90° Quad Tenon	Bronze	
01121	4" Circle Short 90° Quad Tenon	White	
01200	4" Square Low Profile 180° Dual Tenon	Bronze	
01201	4" Square Low Profile 180° Dual Tenon	White	
01202	4" Square Low Profile 180° Quad Tenon	Bronze	
01203	4" Square Low Profile 180° Quad Tenon	White	
01204	4" Square Low Profile 180° Triple Tenon	Bronze	
01205	4" Square Low Profile 180° Triple Tenon	White	
01250	4" Circle Bullhorn 180° Dual Tenon	Bronze	
01251	4" Circle Bullhorn 180° Dual Tenon	White	
01252	4" Circle Bullhorn 180° Triple Tenon	Bronze	
01253	4" Circle Bullhorn 180° Triple Tenon	White	
01254	4" Circle Bullhorn 180° Quad Tenon	Bronze	
01255	4" Circle Bullhorn 180° Quad Tenon	White	

INDOOR CONTROLS - DC



INDOOR CONTROLS - AC



OUTDOOR CONTROLS - DC

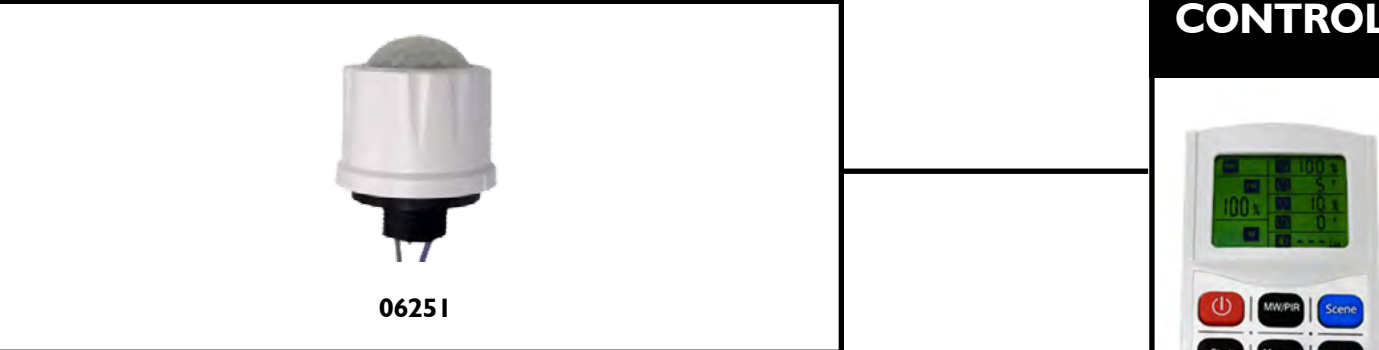

INDEPENDENT CONTROLS



REMOTE CONTROL



SENSORS

Order Code	Description	Height	Voltage	Color	Version	Function
Fixture-Embedded Sensors (Indoor)						
06210	3-in-1 Microwave Fixture Embedded w/ Detachable Sensor	19ft	120-277V	White	Standard	3-in-1*
06230	DC Powered 3-in-1 Microwave Sensor for Sensor Ready Troffer	19ft	10-15 VDC	White	Sensor Ready	3-in-1*
06234	DC Powered 3-in-1 Microwave Sensor for Sensor Ready Round High Bay	49ft	10-15 VDC	Black	Sensor Ready	3-in-1*
06243	DC Powered 3 in 1 Microwave Control for Sensor Ready Magnetic Strips and Flat Panels	19ft	10-15 VDC	White	Sensor Ready	3-in-1*
06258	DC Powered 3 in 1 PIR Control for Sensor Ready Magnetic Strips and Flat Panels	19ft	10-15 VDC	White	Sensor Ready	3-in-1*
Fixture-Mounted Sensors (Indoor)						
06221	LED Microwave Fixture Mounted Sensor	19ft	120-277V	White	Standard	3-in-1*
06223	LED Microwave Fixture Mounted Sensor	49ft	120-277V	Black	Standard	3-in-1*
06224	LED Microwave Fixture Mounted Sensor	49ft	100-277V	Black	45° Angle	3-in-1*
06225	LED Microwave Fixture Mounted Sensor	49ft	347-480V	White	Standard	3-in-1*
06226	LED Microwave Fixture Mounted Sensor	49ft	347-480V	Black	Standard	3-in-1*
06227	LED Microwave Fixture Mounted Sensor	49ft	347-480V	Black	45° Angle	3-in-1*
06245	LED PIR Fixture Mounted Sensor	19ft	120-347V	White	Type D	3-in-1*
06246	LED PIR Fixture Mounted Sensor	39ft	120-347V	White	Type D	3-in-1*
06247	LED PIR Fixture Mounted Sensor	39ft	120-347V	White	Type D	Simple On/Off
06254	LED PIR Fixture Mounted Control 3 in 1 For Troffer	19ft	120-347V	White	Type D	3-in-1*
06240	LED Daylight Harvesting Sensor	-	10-15 VDC	White	Standard	1-10V Dimmer / 10-100% Continuous Dimming
Fixture-Mounted Sensors (Outdoor)						
05714	Twist Lock Photocell for Shoebox & Multi- Purpose Flood	-	100-277V	Blue	Standard	Simple On/Off
05715	Twist Lock Photocell for Shoebox & Multi-Purpose Flood	-	200-480V	Yellow	Standard	Simple On/Off
06251	DC Powered 3 in 1 Sensor for Outdoor Fixtures	49ft	120-277V	Black	Standard	3-in-1*
06451	Photocell Button Style	-	120-277V	Black	Standard	Simple On/Off
09172	Photocell Swivel Style	-	120-277V	Black	Standard	Simple On/Off
Remote Control						
06277	Microwave Control Remote Control	-	-	White	Standard	1 Scene
06278	LED Intelligent Remote Control	-	-	White	Standard	LCD Display

* Functions include occupancy sensor, bi-level dimming, and daylight control.



FAN MOTORS



ANTI-SWEAT



STRIP CURTAINS



DOOR CLOSER



COOLER & VENDING MISERS

Order Code	Product
------------	---------

Fan Motors

08100	ECM Blue 3.3in Evaporator Fan Motor Straight Shaft 115V/208-230V CW/CCW
08101	ECM Blue 3.3in Evaporator Fan Motor Control w/ Thermistors (Controls up to 5 Motors) 08515
08102	ECM Blue Reach-In Motor Screw Shaft 115V/208-230V CW/CCW
08125	Wireless Programmer Kit for Azure Motor 08505
08126	Triangle Mount Bracket 3.3in EC motors Blue
08127	Relay in a Box RIB01P

Anti-Sweat

08010	Relative Humidity Anti-Sweat Heater Control Kit
08011	Anti Sweat Heater Controller

Strip Curtains

08025	QuickStrip - Standard Smooth 8in x .080in x 8ft (1 Strip)
08026	QuickStrip - Standard Smooth 8in x .080in x 296ft (1 roll of 37 x 8ft Strips)
08027	QuickStrip Low Temp Non-Reinforced 8in x .080in x 8ft (1 Strip)
08028	QuickStrip Low Temp Non-Reinforced 8in x .080in x 296ft (1 roll of 37 x 8ft Strips)
08029	QuickMount MD 2FT Section of Mounting Hardware

Door Closers

08000	Light Commercial Door Closer
-------	------------------------------

Cooler & Vending Misers

08015	Cooler Miser with Sensor UL Listed
08016	Cooler Miser w/o Sensor
08017	Vending Miser with Sensor
08018	Vending Miser without Sensor





LED V-SHAPE COLD CASE (COOLER) LIGHT

Description:
This 45° LED V-shape cold case (cooler) light with fixture bracket is ideally used for cooler lighting. The 45° V-shape design has a 160° beam angle that gives products a sharper look as more light shines towards them giving off a perfect 5000k natural white light. These LED lights contain no mercury and are in accordance with CE and RoHS testing standards, in addition to being ETL certified and come in 4', 5' and 6' variations.

- Features:**
- Aluminum polycarbonate lens
 - Suitable for coolers, refrigeration, workshops, warehouses



Order Code	Product	Size	Wattage	CCT	Voltage	Color	Lens	Function
08072	LED Cold Case (Cooler) Light	4ft	18W	6500K	100-277V	White	Clear	Daisy Chain
08073	LED Cold Case (Cooler) Light	5ft	32W	5000K	100-277V	White	Clear	Daisy Chain
08074	LED Cold Case (Cooler) Light	6ft	40W	5000K	100-277V	White	Clear	Daisy Chain

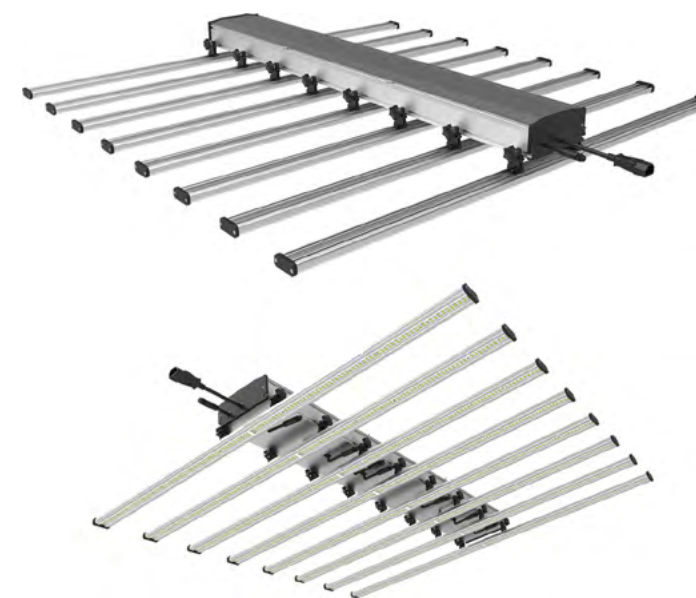

LED SPIDER GROW LIGHTS

Description:
Our full-cycle LED Spider Grow Lights are designed to target only the parts of the spectrum your plants need to thrive through both vegetative and flowering cycles. Continuous dimming (0-10V) comes standard. Suitable for use with dimmers and controllers. Multiple fixtures can be connected together using a single controller and then grouped together to be controlled simultaneously.

- Features:**
- Extruded aluminum with an acrylic lens
 - Suitable for indoor and greenhouse

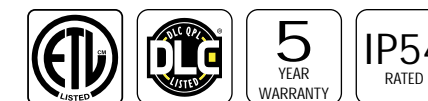

Order Code	Description	Wattage	CCT	Voltage	Color	Lens	Beam Angle	Driver
02990	LED Spider Grow Light	330W	5000K	100-277V	Silver	Clear	120°	Meanwell Driver
02991	LED Spider Grow Light	330W	5000K	100-277V	Silver	Clear	120°	Sosen Driver
02992	LED Spider Grow Light	660W	5000K	100-277V	Silver	Clear	120°	Meanwell Driver
02993	LED Spider Grow Light	660W	5000K	100-277V	Silver	Clear	120°	Sosen Driver

LIGHTING CONTROLS

Order Code	Description
09126	Grow Light Controller System





SOLAR MODULE



Description:
Solar modules convert sunlight to electricity via the photovoltaic effect. The high-power density solar modules yield great power per square meter, decrease labor installation time and decrease balance of system requirements. Dependent on the mounting application (roof or ground), the solar modules integrate various form factors and cell technologies: monofacial, bifacial, mono and poly.

- Features:**
- 30 year linear power warranty
 - 12 year product warranty on materials and workmanship
 - Heavy snow load up to 5400 Pa, wind load up to 2400 Pa
 - IEC 61730, UL 61730 certified
 - Suitable for ground mount and rooftop installations



Order Code	Product	Wattage	Cell Face	Cell Type	Manufacturer
09502	Solar Module	405	Bifacial	Poly	Canadian Solar
09507	Solar Module	440	Non-Bifacial	Mono	Canadian Solar
09508	Solar Module	435	Bifacial	Mono	Canadian Solar
09509	Solar Module	440	Bifacial	Mono	Canadian Solar



SOLAR INVERTER



Description:
Solar inverters convert direct current to alternating current in a photovoltaic system. The grid tied inverter are designed to provide high yield and enable significant balance of system savings. Dependent on system requirements, the inverter are either single phase or three phase. Conversion efficiency yields up to 98.8% and a wide operating range.

- Features:**
- 10 year standard warranty, available to extend up to 20 years
 - Maximum efficiency of 98.8%
 - UL 1741 & IEC 62109.1 certified for safety
 - IEEE 1547 & EC 62109.2 certified for safety & operability with utility grid
 - Monitoring for real-time operational efficiency



Order Code	Product	Rated AC Power	Manufacturer
09503	Inverter	60,000	Canadian Solar
09504	Wirebox	50,000-60,000	Canadian Solar

DATA MONITORING

CSI Cloud Apps

CSI WiFi Stick

WiFi Stick



LIGHTING. **CONTROLS.** SOLAR.

ORDERS

orders@maverickled.com

RMA

rma@maverickled.com

CONTACT

PHONE

214.571.6374

GENERAL INFORMATION

sales@maverickled.com

WEBSITE

maverickled.com

ESS/ESCO PRICING

maverickled.com/pages/contact-us