

LED Linear High Bay Installation Instruction

3.Backup driver:

Step1. Knock off the knockout hole on the back of the fixture, take out the wires from the knockout hole (Figure. 12), open the front cover of the fixture, and knock out the two knockout holes on the cover (Figure. 13);

Step2. Open the cover of the backup driver box, install the backup driver box at the corresponding position on the back of the fixture (Figure 14), connect the wires correspondingly according to the marking instructions on the wire, mount the buttons and indicators of backup driver on the front cover of the fixture (Figure 15), then fix the cover to the fixture.

Step3. After mounting, choose suitable wiring knock out and do wiring according to local standard and code.

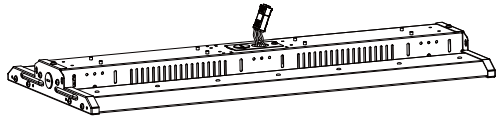

Figure12

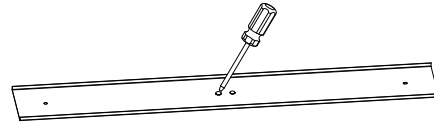

Figure13

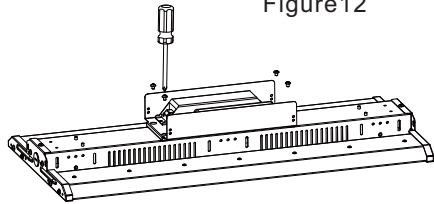

Figure14

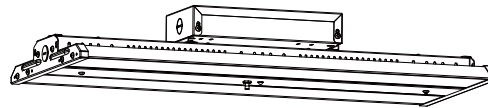

Figure15

Possible maximum product weight(when specific mounts or function was chosen)

Power	Net Weight / Carton	Product Dimension
90W	5.4KG Max	630x300mm
110W	5.4KG Max	630x300mm
135W	5.9KG Max	630x300mm
165W	5.9KG Max	630x300mm
220W	6.5KG Max	630x360mm
220W	8.5KG Max	900x385mm
300W	9.3KG Max	900x385mm
320W	9.3KG Max	900x385mm

Warning / Avertissement

MIN 90 °C SUPPLY CONDUCTOR

THIS PRODUCT MUST BE INSTALLED IN ACCORDANCE WITH THE APPLICABLE INSTALLATION CODE BY A PERSON FAMILIAR WITH THE CONSTRUCTION AND OPERATION OF THE PRODUCT AND THE HAZARDS INVOLVED

LES FILS D'ALIMENTATION 90 °C MIN

CE PRODUIT DOIT ÊTRE INSTALLÉ SELON LE CODE D'INSTALLATION PERTINENT, PAR UNE PERSONNE QUI CONNAÎT BIEN LE PRODUIT ET SON FONCTIONNEMENT AINSI QUE LES RISQUES INHÉRENTS.

Cautions:

1. Can not use the electric generator to test the LED lamp.
2. Please abide by related country, regional and local law and regulations when install this fixture.
3. Please turn off the power before installation or maintenance.
4. Proper earth grounding is required to ensure safety.

Notice:

1. To avoid possibility of electrical shock or fire, the installation personnel must have professional electric knowledge.
2. Please wear gloves to avoid injury before installation.
3. If any smoke or spark of the wire happened, please turn off the power immediately and notify relevant personnel.

Attention:

1. Please check if there is any damage during shipping. If so, please contact manufacturer timely.
2. Please read the installation instruction carefully to check whether all the accessories are complete. After confirmation, then install the fixture according to installation steps.

Wiring Diagram & Instruction:

3 dimming functions are available in this high bay light:

1. Constant current can be achieved by 1-10VDC dimming;
2. PWM signal dimming;
3. Variation of resistance unit dimming.

Wiring Instruction

L:Black

N:White

⊕: Green/Yellow

+DIM: Purple

- DIM: Grey

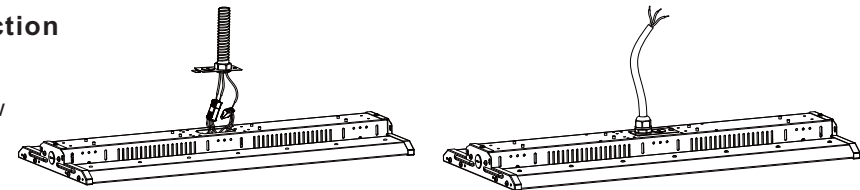

Backup Driver Wiring

Step1. Open junction box with screw driver

Step2. Connect the input wires on each backup driver and fixture driver via suitable knock out, then complete the junction box.

Wiring Instruction

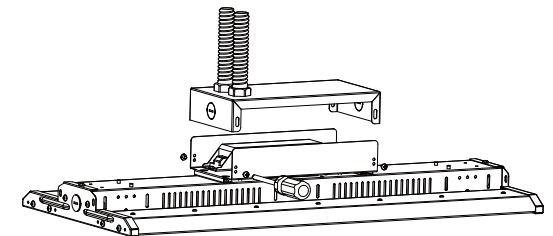
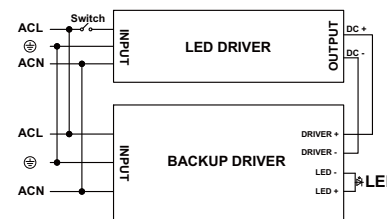

Please choose the appropriate dimming way according to your needs. You can also choose not to use this function.

*The product can not be connected to a dimming device when it's equipped with Motion Sensor.

Three Installation : Chain/Cable Installation, 3/4"NPT Installation, Surface Mounting /Pendent Mounting(Please choose the most suitable installation method for the purchased product as per your needs)

A. Hanging Installation: (Chain/Cable)

- Step1. Hook up the chain; (Figure 1)
- Step2. Connect the chain with fixture; (Figure 1)
- Step3. Fix the chain on the rail, adjust the chain length as per need; (Figure 1)
- Step4. After the fixing , choose suitable wiring knock out, do wiring according to local standard and code.

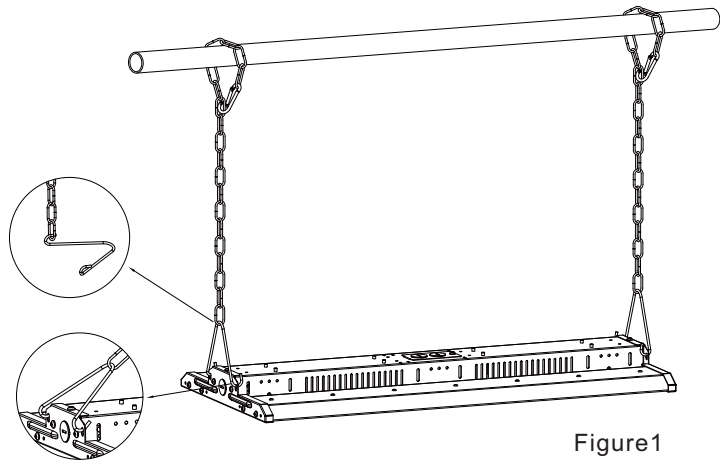

Figure1

B. 3/4"NPT Installation: (If this bracket is used for the fixture, backup driver solution cannot be chosen)

- Step1. Mount the bracket on 3/4"NPT (Figure 2);
- Step2. Lock fixture on the bracket (Figure 3);
- Step3. Do wiring according to local standard and code.
- Step4 Lock side brackets with screw driver (Figure 4).

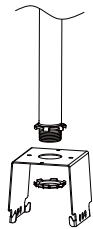

Figure2

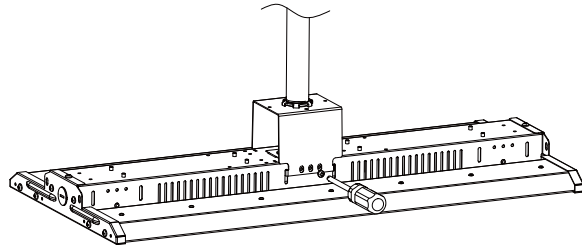

Figure3

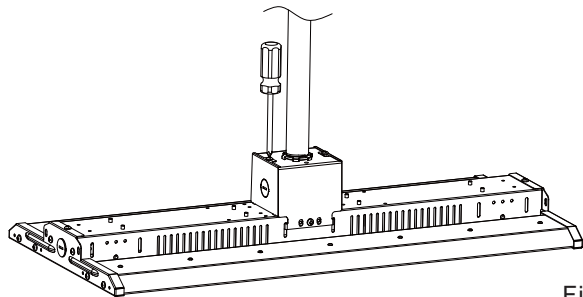

Figure4

C. Surface Mounting/ Pendant Mounting:

- Step1. Mount the bracket on the rail or ceiling (Figure 5) ;
- Step2. Mount bolt on the rail or ceiling, and mount the fixture bracket on the bolt (Figure 6); and then install the fixture. (Figure 7).
- Step3. After mounting, choose suitable wiring knock out and do wiring according to local

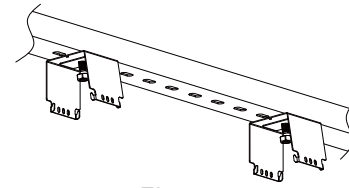

Figure5

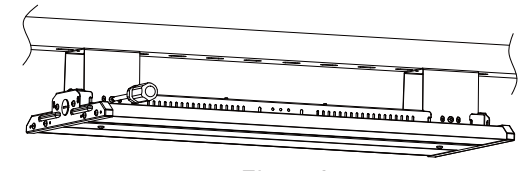

Figure6

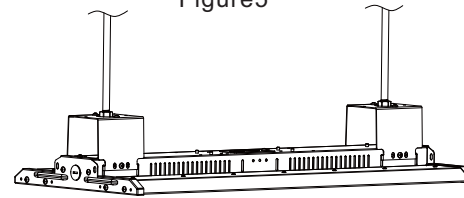

Figure7

Extra Accessory Option Installation: 1:Wire Guard, 2:Motion Sensor /PIRSensor, 3:Backup driver

- 1.Wire Guard:(Purchase the correct size wire guard from manufacturer)
- Step1. Mount the wire guard on the fixture with screws (Figure 8)

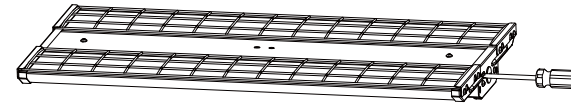

Figure8

2. Motion Sensor /PIRSensor:(Both sensor are with same installation)

- Step1. Open the face cover with screw driver (Figure 9)
- Step2. Knock out the side cover, mount the sensor on the side, do wiring accofing to instruction on sensor (Figure 10).
- Step3. Put face cover back with screw driver (Figure 11).

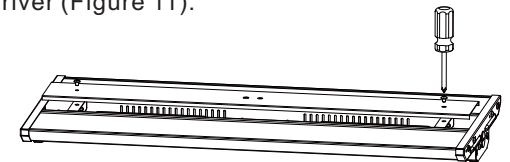

Figure9



Figure10



Figure11

Wiring Instruction

