

VICTROLA

Side: A
45 RPM

FOR MORE INFORMATION
SCAN BELOW



THE REVOLUTION GO

VSC-750SB

QUICK START GUIDE

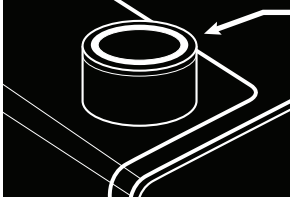

FUNCTION KNOB - BASIC OPERATION

POWER: Press and hold for 1-2 seconds to turn the unit ON or OFF.
VOLUME: Rotate to raise or lower volume.

FUNCTION KNOB - TO CYCLE THROUGH FEATURES

VINYL: Press to enter record player function mode.
VINYL STREAM: Press to connect the unit to an external Bluetooth speaker.
BLUETOOTH: Press to pair the unit with a Bluetooth device (smartphone).

OPERATION	RING COLOR	FUNCTION & VOICE PROMPT
	WHITE	POWER ON: Press and hold for 1-2 seconds.
		POWER OFF: Press and hold for 1-2 seconds. <i>When powering back ON, the unit will return in the last used function mode.</i>
	WHITE	Press for: VINYL PLAYING: "Vinyl"
	WHITE	Press for: VINYL STREAM: "Vinyl Stream" "Vinyl Stream" Dial will FLASH when searching. When connected, prompt will say "Connected" & dial will turn SOLID. <i>In Vinyl Stream mode, internal speakers will be disengaged.</i>
	BLUE	Press for: BLUETOOTH: "Bluetooth" Dial will FLASH when searching. When connected, prompt will say "Connected" & dial will turn SOLID.
	WHITE	RAISE VOLUME: Rotate dial CLOCKWISE. <i>Dial will brighten when in use. Unit will chime when MAX volume is reached.</i>
		LOWER VOLUME: Rotate dial COUNTER-CLOCKWISE. <i>Dial will brighten when in use.</i>
	WHEN THE UNIT IS DISCONNECTED FROM A POWER SOURCE, battery level will prompt as needed.	BATTERY VOICE PROMPTS >80% "Battery Full" 26%–79% "Battery Medium" <25% "Battery Low" <10% "Low Battery"

REVOLUTION GO OVERVIEW

Top View

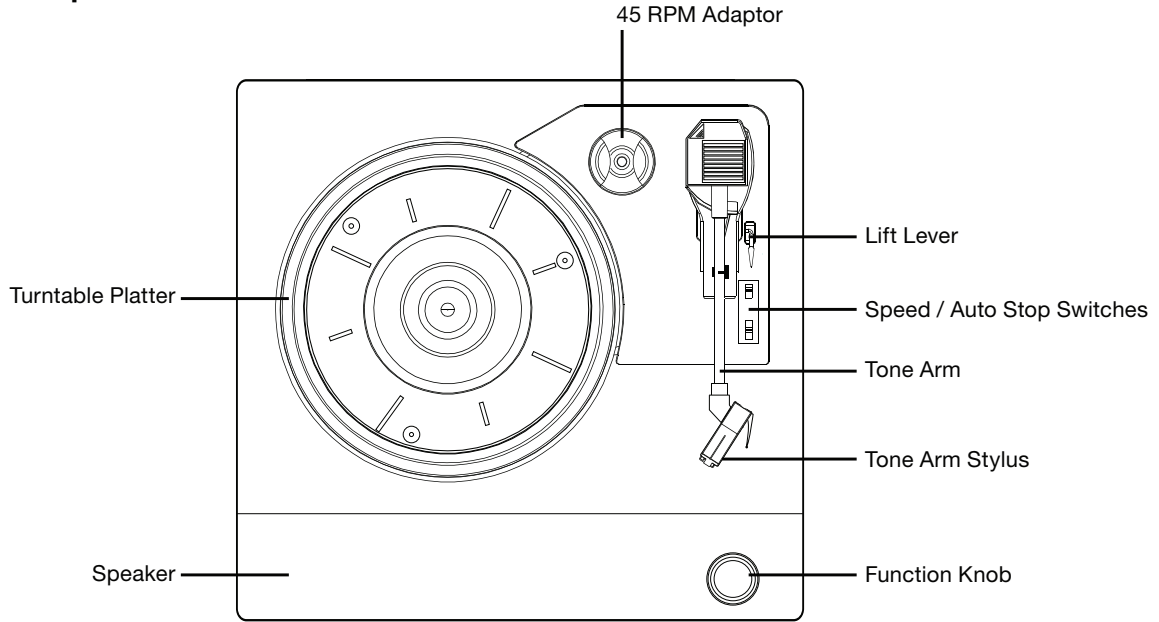

Rear View

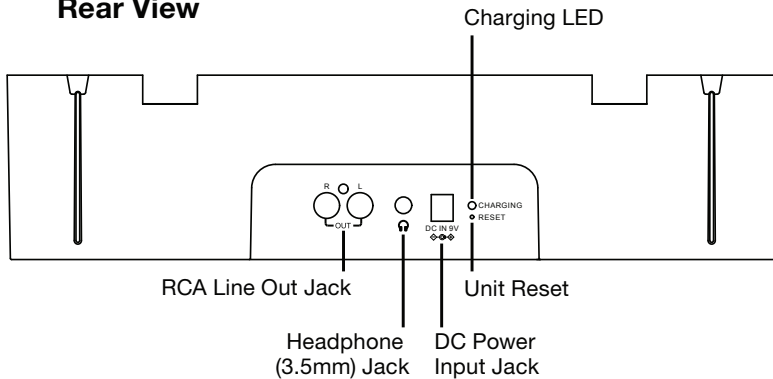

Bottom View

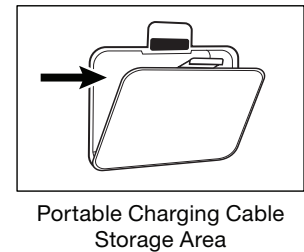

RECORD HOLDER LID

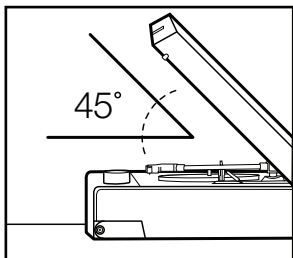

REMOVE RECORD FROM UNIT &
LOWER THE LID AT A 45° ANGLE

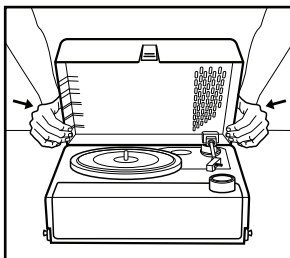

APPLY LIGHT PRESSURE TO
THE BOTTOM SIDES OF THE LID

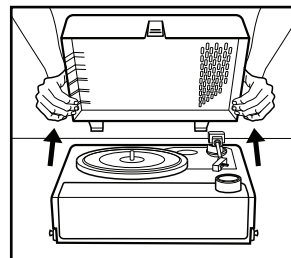

WHILE LID IS STILL AT 45°, PULL
STRAIGHT UPWARD TO REMOVE

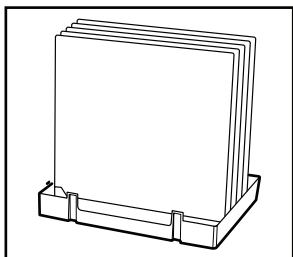

THE LID IS NOW AN
AWESOME RECORD HOLDER

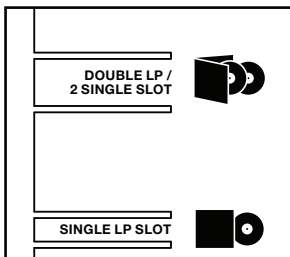

PLEASE NOTE THE ICONS
FOR SINGLE OR DOUBLE LPs

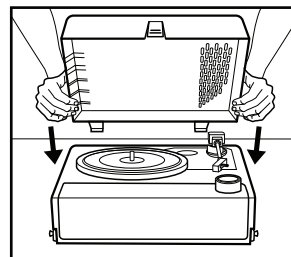

FOLLOW THE STEPS ABOVE
IN REVERSE TO REATTACH LID

GUITAR STRAP CARRY HANDLE

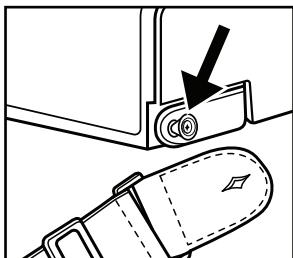

SLIDE THE CARRY STRAP
OVER BOTH SIDE KNOBS

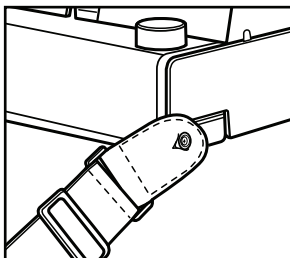

MAKE SURE THE STRAP IS
SECURE ON EACH SIDE KNOB

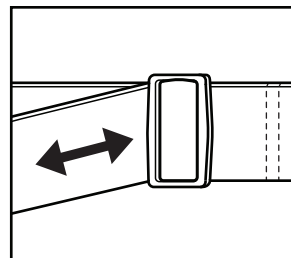

ADJUST THE STRAP LENGTH
IF NEEDED AND ENJOY!

S I M P L E S E T U P



GETTING STARTED

Remove the needle cover, by gently pulling towards the front of the unit. Carefully plug in the unit and remove any accessories from the platter.

Note: It is recommended that this product should be operated only from the type of power source indicated on the power adaptor.

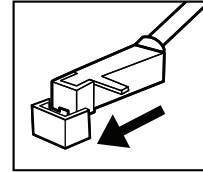

BASIC OPERATION

Using the Function Knob, press and hold for 1-2 seconds to turn the unit ON or OFF.

Cycle through the Function Knob to select from the following playing modes:

VINYL: Playing a Vinyl record.

VINYL STREAM: Connecting to an external Bluetooth speaker or headphone.

BLUETOOTH: Connecting and playing music from a Bluetooth device (smartphone).

VOLUME: Rotate to raise or lower the volume.



RCA LINE OUT: Use the red & white plugs on the back of the unit to connect to an amplifier/stereo device. Be sure to first reduce the volume to a minimum level on the record player.



HEADPHONE: Use the headphone jack on the back of the unit to connect your headphones/earbuds. Be sure to first reduce the volume to a minimum level on the record player.

B A T T E R Y I N F O



RECHARGEABLE BATTERY LIFE

The following is the estimated playing time of the record player, which may vary slightly in actual use.

PLAY MODE	VOLUME LEVEL	PLAY TIME	BATTERY SPECIFICATION INFORMATION
BLUETOOTH	100%	9 Hours	Charge time: 4 Hours to fully charge. Rechargeable Li-ion Battery TPS 18650/2S 18wh;7.2V 2500mA Size: 65*37*18/2100 Pole: Red wire + Black wire - Caution: Risk of fire and burn. Do not open, crush, or heat above 60°C. Shenzhen Topshes Technology Co., Ltd
	50%	13 Hours	
VINYL	100%	8 Hours	
	50%	12 Hours	

When charging the battery, the Charging LED on the back of the unit will be RED. When charging is complete, the Charging LED will turn OFF.

VINYL PLAYING



VINYL: Playing a Vinyl record

Using the Function Knob, press and hold for 1-2 seconds to turn the unit ON. Simply press the Function Knob to make sure it is in Vinyl mode (the dial will illuminate white). Remove the needle cover, by gently pulling towards the front of the unit. Select the proper record speed. *If using a 45 RPM record, use the included 45 adaptor.* Release the Tone Arm from the holder and gently place on the record using the lift lever. Rotate the Function Knob to adjust the volume if needed.

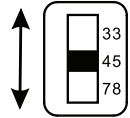

Note: -Make sure to only touch the center or edges of the record to avoid damage to the vinyl grooves.

-If no sound is playing, the unit may be in Vinyl Stream mode, cycle through the function knob to make sure it is in Vinyl mode.

Auto and Manual Stop Selection Switch: If this switch is turned ON, The record will start spinning when the tone arm moves over the record and the record will stop automatically when playback is finished. If this switch is OFF, the record will automatically begin to spin when the unit is in "VINYL" function mode and the record will continue to spin after playback is finished.

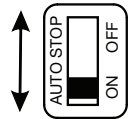

NEEDLE REPLACEMENT



HOW TO REPLACE THE TURNTABLE STYLUS (REPLACEMENT STYLUS # ATN3600L)

Removing the Stylus from the Cartridge

1. Place your fingers at the tip of the stylus and push down to the direction "A".

WARNING: When applying force to stylus, too much may damage or break the cartridge.

2. Pull the stylus out toward the direction "B".

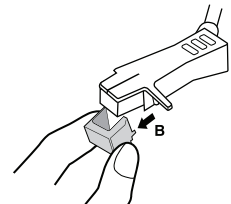
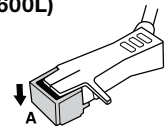

Installing the Stylus

1. Hold the tip of the stylus and insert the other edge by pressing toward direction "C".
2. Push the stylus up toward direction "D" until it locks at the tip.

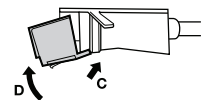

Caution:

Do not remove or bend the stylus needle.

Do not touch the needle to avoid injury to your hand.

Turn off the unit's power before you replace the stylus.

Keep out of reach of children.

Note: The stylus should last about 300 hours under normal use.

It is recommended that the stylus be replaced as soon as you notice a change in sound quality. 78 RPM records may accelerate stylus wear and may have to be changed sooner.

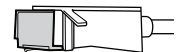

V I N Y L S T R E A M™



VINYL STREAM: Playing a Vinyl record on an external Bluetooth speaker or headphones.

Using the Function Knob, press and hold for 1-2 seconds to turn the unit ON.

Simply press the Function Knob to make sure it is in Vinyl Stream mode (the dial will flash white).

Turn ON your external Bluetooth speaker or headphone, and set to pairing mode.

Wait a few seconds for the unit to find your device.

The unit will chime and say “*Connected*”, while the Function Knob will remain white.

Use your external device to control the volume.

Note: *-In Vinyl Stream mode, internal speakers will be disengaged.*

-We recommend placing the Bluetooth device within 1m (3.3') of the product when initially pairing.

-Make sure the unit is within 10m (33ft) from your external device for the strongest connection.

-Vinyl Stream is only compatible with vinyl record playback.

-The product stays in the pairing mode for 30 seconds. If pairing is not properly completed, follow the above steps again from the beginning after turning all devices OFF.

B L U E T O O T H P A I R I N G



BLUETOOTH: Connecting and playing music from an Bluetooth device (Smartphone).

Using the Function Knob, press and hold for 1-2 seconds to turn the unit ON.

Simply press the Function Knob to make sure it is in Bluetooth mode (the dial will flash blue).

On your device, turn Bluetooth ON. Then search for and select “**REVOLUTION GO**” in the settings menu.

The unit will chime and say “*Connected*”, while the Function Knob will remain blue.

Use your external device to control playback.

Rotate the Function Knob to adjust the volume if needed.

Note: *-Make sure the unit is within 10m (33ft) from your external device for the strongest connection.*

-If no sound is playing, the unit may be in Vinyl Stream mode, cycle through the function knob to make sure it is in Bluetooth mode.

WARNING

- Always follow basic safety precautions when using this appliance, especially when children are present.
- Children should be supervised to ensure that they do not play with the appliance.
- Do not damage the power cord, neither do not place any heavy objects on it, do not stretch it or bend it. Also do not attach extension cables. Damage to the power cord may occur fire or electric shock.
- If the supply cord is damaged, it must be replaced by the manufacturer, a service agent or similarly qualified persons in order to avoid a hazard.
- Ensure that the unit plugged into an AC 100-240v 50/60Hz power outlet. Using higher voltage may cause the unit to malfunction or even catch fire.
- If the power plug does not fit into your outlet, do not force the plug into an electrical socket if it does not fit.
- Turn off the unit before unplugging it from the power source to completely switch it off.
- Do not disconnect or connect the power cord with wet hands. It may cause an electrical shock.
- Ensure that the main plug is always easily accessible.
- This product does not contain any parts that are serviceable by the user. In case of a fault, contact the manufacturer or authorized service department. Exposing the internal parts inside the device may endanger your life. The manufacturers guarantee does not extend to faults caused by repairs carried out by the unauthorized third parties.
- Ensure this product is used in moderate climates only (not in tropical/subtropical climates).
- Place product on a flat, stable surface that is not subject to vibrations.
- Ensure the product and its parts are not overhanging the edge of the supporting furniture.
- To reduce the risk of fire, electric shock or damage to this product, do not expose it to direct sunlight, dust, rain and moisture. Never expose it to dripping or splashing and do not place objects filled with liquids on or near the product.
- Do not place objects filled with liquids, such as vases, on the apparatus.
- Do not install near any heat sources such as radiators, heat registers, stoves or other apparatus (including amplifiers) that produce heat.
- Do not place the product where the humidity is high and ventilation is poor
- Do not mount this product on a wall or ceiling.
- Do not place the unit near TV's, speakers and other objects that generate strong magnetic fields.
- Do not leave the unit unattended when in use.
- Allow at least 30cm clearance from the rear and the top of the unit and 5cm from each side. Always ensure that the ventilation openings are not covered with items such as newspapers, tablecloths, curtains, etc.
- NEVER let anyone, especially children, push anything into holes, slots or any other openings in the unit's casing as this could result in a fatal electric shock.
- Storms are dangerous for all electric appliances. If the main or aerial wiring is struck by lightning, the appliance might get damaged, even if it turned off. You should disconnect all the cables and connectors of the appliance before a storm.
- Excessive sound pressure from headphones can cause hearing loss.
- Do not cover ventilation openings, this is not intended to be used on soft support.

MAINTENANCE:

- Unplug the power cable from the power source before cleaning the appliance.
- Use a soft clean rag to clean the outside of the unit. Never clean it with chemicals or detergent.

WARNING

CAUTION: WARNING TIPS OF BATTERY:



- 1) Risk of explosion if the battery is replaced by an incorrect type;
- 2) High or low extreme temperatures that a battery can be subjected to during use, storage or transportation; and low air pressure at high altitude.
- 3) Replacement of a battery with an incorrect type that can defeat a safeguard (for example, in the case of some lithium battery types);
- 4) Disposal of a battery into fire or a hot oven, or mechanically crushing or cutting of a battery, that can result in an explosion;
- 5) Leaving a battery in an extremely high temperature surrounding environment that can result in an explosion or the leakage of flammable liquid or gas;
- 6) A battery subjected to extremely low air pressure that may result in an explosion or the leakage of flammable liquid or gas.

CONDENSATION WARNING:

When the unit is moved from a cold or warm place, or is used following a sudden temperature change, there is the danger that water vapor in the air may condense on the unit, preventing proper operation. In such cases, leave the unit for 1-2 hours after plugging it into an AC outlet to allow it to stabilize at the temperature of its surroundings.

OUTDOOR WARNING:

Be careful using the unit in direct sunlight or wet weather conditions. This unit cannot get wet in any way and direct sunlight can damage some vinyl records during playback. Always check weather conditions before taking the unit or vinyl records outside.

AUTO STAND-BY MODE:

After 15 minutes without any audio input, the device will automatically switch into Please follow up the instruction manual to resume the operations.

Please note: As a result of continual improvements, the design and specifications of this product are subject to change without notice.

Bluetooth is a registered trademark of Bluetooth SIG, Inc.
Other trademarks and trade names are those of their respective owners.

MADE IN CHINA.

CALIFORNIA PROP 65 WARNING



WARNING: This product can expose you to chemicals including Lead, which is known to the State of California to cause cancer, and Bisphenol A (BPA) & Phthalate, which are known to the State of California to cause birth defects or other reproductive harm.

For more information go to www.P65Warnings.ca.gov.

SAFETY INSTRUCTIONS

POWER ADAPTER:

- To disconnect the unit from the main supply, unplug the lead from the main socket.
- Only use the supplied main adapter, as failure to do this may result in a safety risk and/or damage to the unit.
The main plug of power adapter is used as the disconnect device. The socket-outlet shall be installed near the equipment and shall be easily accessible.

TO PREVENT FIRE OR SHOCK HAZARD, DO NOT USE THIS PLUG WITH AN EXTENSION CORD, RECEPTACLE OR OTHER OUTLET UNLESS THE BLADES CAN BE FULLY INSERTED TO PREVENT BLADE EXPOSURE. TO PREVENT FIRE OR SHOCK HAZARD, DO NOT EXPOSE THIS APPLIANCE TO RAIN OR MOISTURE.



Please read these safety instructions and respect the following warnings before the appliance is operated:

- ~ AC Voltage
- ≡ DC Voltage
- Class II equipment
- 🏠 For indoor use only
- Ⓜ Energy Efficiency marking with level VI
- ↔ Polarity of D.C power connector

- The shown above appears on electrical and electronic equipment (or the packaging) to remind users of this.
- Users are requested to use existing return facilities for used equipment and batteries.



SPECIFICATIONS

GENERAL

Power Adaptor9V/1.5A
Power Consumption13.5W
Power Output2 x 5W
Operating Temperature5°C +- 40°C

RECORD PLAYER

Speeds33-1/3, 45 & 78 RPM
--------------	----------------------

BLUETOOTH

Bluetooth VersionBluetooth V5.0
Bluetooth ProfileA2DP, AVRCP
Bluetooth Frequency Range2.40GHz-2.480GHz
Operating Distance10 meters (33 ft.)

ADAPTOR

ManufacturerGW-POWER
ModelGW18W-090150UV

INCLUDED:

Revolution Go with Removable Lid,
Guitar Strap, Slipmat, Power Adaptor,
45 RPM Adaptor, Instruction Manual

FCC WARNINGS

FCC STATEMENTS

Caution: the user is cautioned that charges or modifications not expressly approved by the party responsible for compliance could void the user's authority to operate the equipment.

This device complies with part 15 of the FCC rules and Industry Canada license-exempt RSS standard(s). Operation is subject to the following two conditions:

- (1) This device may not cause harmful interference, and
- (2) This device must accept any interference received, including interference that may cause undesired operation.

Le présent appareil est conforme aux CNR d'Industrie Canada applicables aux appareils radio exempts de licence. L'exploitation est autorisée aux deux conditions suivantes:

- (1) l'appareil ne doit pas produire de brouillage, et
- (2) L'utilisateur de l'appareil doit accepter tout brouillage radioélectrique subi, même si le brouillage est susceptible d'en compromettre le fonctionnement.

NOTE:

This equipment has been tested and found to comply with the limits for a Class B digital device, pursuant to Part 15 of the FCC Rules. These limits are designed to provide reasonable protection against harmful interference to radio communications. However, there is no guarantee that interference will not occur in a particular installation.

If this equipment does cause harmful interference to radio or television reception, which can be determined by turning the equipment off and on, the user is encouraged to try to correct the interference by one of more of the following measures:

- Reorient or relocate the receiving antenna.
- Increase the separation between the equipment and receiver.
- Connect the equipment into an outlet on a circuit different from that to which the receiver is connected
- Consult the dealer or an experienced radio/TV technician for help.

FCC & IC WARNINGS

FCC & IC RADIATION EXPOSURE STATEMENT:

This equipment complies with FCC and Canada radiation exposure limits set forth for an uncontrolled environment. This equipment should be installed and operated with a minimum distance of 20cm between the radiator and your body. This transmitter must not be co-located or operating in conjunction with any other antenna or transmitter.

DÉCLARATION D'IC SUR L'EXPOSITION AUX RADIATIONS:

Cet équipement est conforme aux limites d'exposition aux radiations définies par le Canada pour des environnements non contrôlés. Cet équipement doit être installé et utilisé à une distance minimum de 20cm entre l'antenne et votre corps. Cet émetteur ne doit pas être installé au même endroit ni utilisé avec une autre antenne ou un autre émetteur.

WARRANTY

Victrola is a registered trademark of Innovative Technology Electronics, LLC.

United States

Victrola (Innovative Technology Electronics, LLC) warrants to the original retail purchaser that this product will be free from defective materials and workmanship for one (1) year from the date of purchase, subject to the limitations below. This warranty period is not extended if we replace the product.

To obtain a replacement under the terms of this warranty, you must contact the dealer from which it was purchased with your original receipt. If assistance from the dealer from which it was purchased is impossible, you may contact our customer service for warranty assistance at victrola.com/contact.

Except as limited below, if the product proves defective in either material or workmanship within one (1) year from the date of purchase, Victrola will replace the product at no charge. If the product model is no longer available and cannot be replaced with an identical model, Victrola will issue a merchandise credit for the purchase price to be redeemed at victrola.com.

Limitations:

- This limited warranty does not cover failure of the product arising, in whole or in part, from improper installation, storage, transportation, misuse, abuse, accident, neglect, mishandling, unauthorized repair, modification, or wear from ordinary use or environmental deterioration.
- This limited warranty does not cover cosmetic damage, including paint damage, or consequential damage to other components or premises which may result for any reason from the failure of the product.
- This limited warranty is null and void for products not used in accordance with Victrola's instructions.
- This limited warranty terminates if the original retail purchaser sells or otherwise transfers this product.
- This limited warranty is null and void for defects or damage caused by installation or repair performed by any person or entity other than a Victrola authorized installer or dealer.

WARRANTY

This warranty gives you specific legal rights, and you may also have other rights which vary from state to state, jurisdiction to jurisdiction or country to country. All express and implied warranties for the product, including but not limited to any implied warranties of merchantability and fitness for a particular purpose, are limited in time to the term of this warranty. Some states, jurisdictions or countries do not allow the exclusion of certain implied warranties or conditions, or limitations on how long an implied warranty or condition lasts, so this limitation may not apply to you. Victrola's responsibility for malfunctions and defects in hardware is limited to replacement or repair as set forth in this warranty statement. Victrola does not accept liability for special, punitive, consequential or incidental damages or losses, whether direct or indirect, including without limitation, any liability for third party claims against you for damages or losses or for products not being available for use. The maximum liability for which Victrola may be responsible will be no more than the amount you paid for the product that is the subject of the claim. Some states, jurisdictions or countries do not allow the exclusion or limitation of special, indirect, incidental or consequential damages, so the above limitation or exclusion may not apply to you.

Canada and US Territories

The Warranty on this product shall comply with applicable law when sold to a consumer in Canada or a US Territory. To obtain any applicable warranty service, please contact the dealer from which you purchased the product, or the distributor that supplied the product, with your original receipt. If assistance from the dealer from which it was purchased is impossible, you may contact our customer service for warranty assistance at victrola.com/contact. If this product proves defective in either material or workmanship, Victrola will replace the product at no charge. If the product model is no longer available and cannot be repaired effectively or replaced with an identical model, Victrola at its sole option may replace the unit with a current model of equal or greater value.

Outside the U.S, Canada, and US Territories

The Warranty on this product shall comply with applicable law when sold to a consumer outside of the United States, Canada, and US Territories. To obtain any applicable warranty service, please contact the dealer from which you purchased the product, or the distributor that supplied the product, with your original receipt.

Thank you for buying a Victrola.