



T1 TURNTABLE

VPT-1000

OVERVIEW

Top View

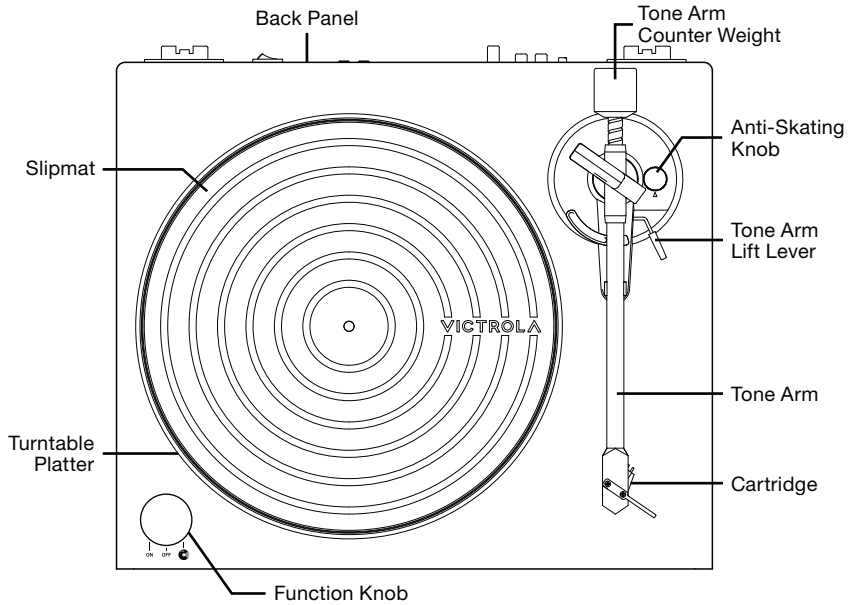

Back View

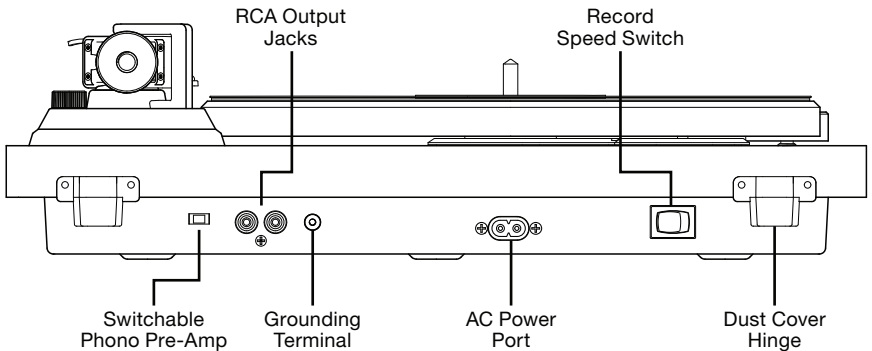

QUICK START GUIDE

FUNCTION KNOB - BASIC OPERATION

POWER ON /OFF: Turn the Function Knob to the left to turn the unit ON. Turn the Function Knob to the middle to turn the unit OFF.

Note: The dial will illuminate solid white when turned ON. When the unit is OFF the dial will not be illuminated.

VINYL STREAM: Turn the Function Knob to the right to connect the unit to an external Bluetooth speaker.

Note: The dial will flash White when pairing to a Bluetooth speaker. When both devices are paired, the dial will be illuminated White.

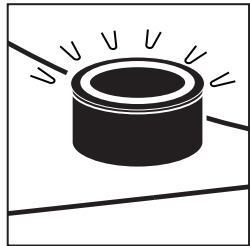
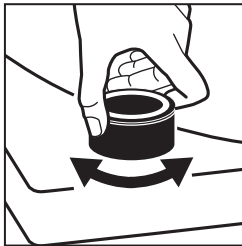
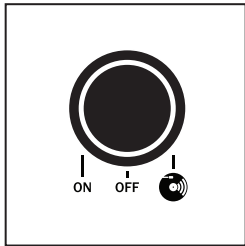

DUST COVER INSTALLATION

DUST COVER: Locate the plastic hinges in the accessory box. Slide the hinges into the supports on the back of the turntable. Locate the dust cover and match the unit hinges with the dust covers slots and slide the lid down into the slot.

Note: When the unit is not in use, it is best to leave the lid covered.

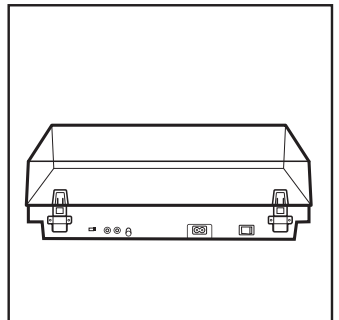
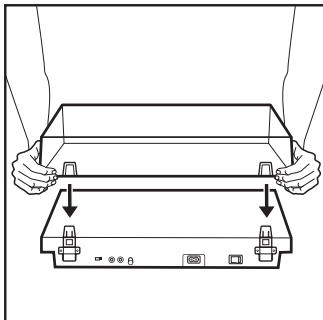
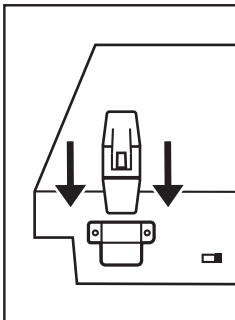

S I M P L E S E T U P



GETTING STARTED

Remove the needle cover, by gently pulling towards the front of the unit. Carefully plug in the unit, install platter and tone arm weight.

Note: It is recommended that this product should be operated only from the type of power source indicated on the rating label. This unit uses AC power and is powered by a standard wall outlet.

CONNECTING THE SPEAKERS:



RCA LINE OUT: Use the red & white plugs on the back of the unit and included RCA cables to connect to an amplifier/stereo device. Once connected, switch ON the unit and the amplifier device you connected. Then adjust the volume on the amplifier device.

SWITCHABLE PHONO PRE-AMP: This switch allows the internal stereo phono pre-amp to be bypassed when the turntable is used with equipment that has magnet phono inputs. Unless you are using equipment with magnetic phono inputs, the switch should be set to "LINE". Improper setting of the switch may lead to no sound or loud unwanted feedback.

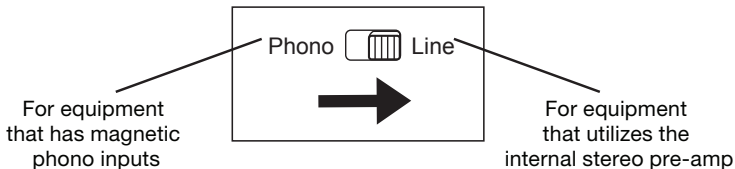

P L A T T E R I N S T A L L A T I O N

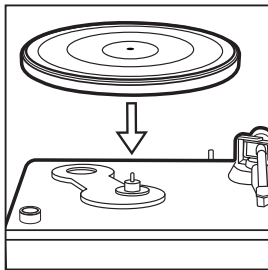

PLACE THE PLATTER ON THE TURNTABLE. THE BELT IS PRE-INSTALLED UNDER THE PLATTER

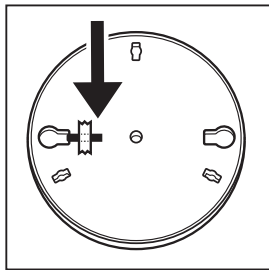

FIND THE GUIDE STRING TAPED TO THE PLATTER AND CAREFULLY REMOVE THE TAPE WHILE HOLDING THE STRING

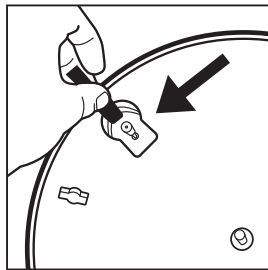

USE THE STRING TO PULL THE BELT OVER THE MOTOR PIN - ONCE BELT IS ON MOTOR PIN, DISCARD THE GUIDE STRING

TONE ARM SETUP

*****IMPORTANT, THE TONE ARM MUST BE SET UP AS INSTRUCTED BELOW OR DAMAGE MAY OCCUR TO THE UNIT OR RECORDS.**

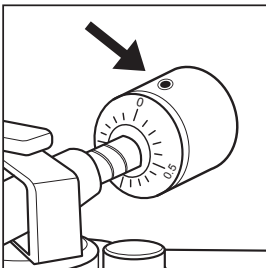

IDENTIFY THE WEIGHT ON THE BACK OF THE TONE ARM. USE THE INCLUDED 2.5MM HEX KEY TO LOOSEN THE SET SCREW

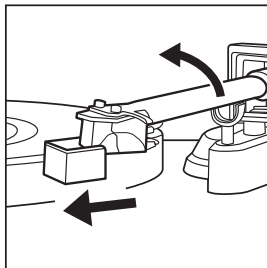

REMOVE THE NEEDLE COVER - LIFT TONE ARM OUT OF THE HOLDER TO THE LEFT SO IT FLOATS FREELY - NOT TOUCHING ANYTHING

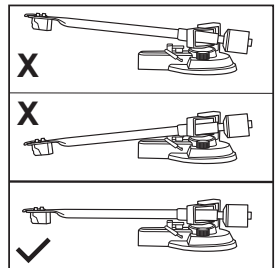

TURN THE COUNTER WEIGHT ON THE BACK OF TONE ARM UNTIL THE TONE ARM IS FLAT AND BALANCED (SEE BOTTOM PICTURE)

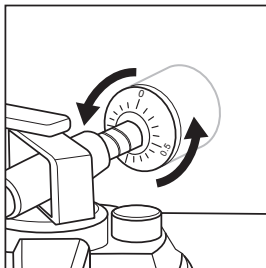

SET ONLY THE "NUMBER" RING, SO "0" IS IN THE TOP MOST POSITION: DO NOT LET THE REAR WEIGHT TURN (NUMBER RING AND COUNTER WEIGHT MOVE SEPARATELY FROM EACH OTHER)

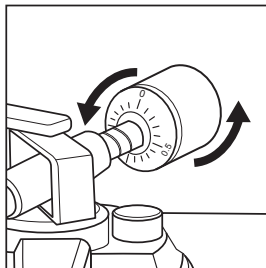

HOLDING BOTH THE NUMBER RING & COUNTER WEIGHT, ROTATE COUNTERCLOCKWISE 1 1/2 ROTATIONS UNTIL YOU END ON "1", THAN TIGHTEN SET SCREW

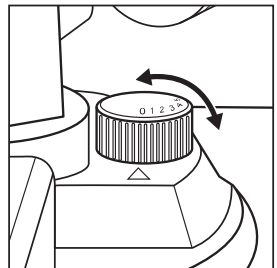

ONCE THE COUNTER WEIGHT IS SET, ADJUST THE ANTI-SKATE CONTROL TO THE RECOMMENDED SETTING OF "1.5"

The purpose of the counter weight is to set the tone arm to 3 grams of downward force, the recommended tracking weight for this cartridge. (One full counterclockwise turn with the counter weight is equal to 2g, that is why you continue to turn counterclockwise until "1")

ANTI-SKATING ADJUSTMENT *The anti-skating function helps compensate inward tracking force that occurs with certain records when the stylus (needle) nears the center or end of the record.*

Once the counterweight is set, adjust the anti-skate control. For the included cartridge, the recommended anti-skate setting should be "1.5".

If you notice excessive skipping or tonearm pulling inward or outward, you can adjust the anti-skate as needed.

VINYL PLAYING



VINYL: Playing a Vinyl record

Note: *-Before using, make sure the tone arm is properly setup.*

See TONE ARM SETUP page.

Using the Function Knob, turn the knob to ON.

(the dial will illuminate solid white.)

Remove the needle cover, by gently pulling towards the front of the unit.

Select the proper record speed (see back of unit).

If using a 45 RPM record, use the included 45 adaptor.

Release the Tone Arm from the holder and gently place on the record using the lift lever.

Use your external device to control the volume.

Note: *-Make sure to only touch the center or edges of the record to avoid damage to the vinyl grooves.*

-Do not adjust the counter weight while playing a record as this could break the needle and scratch the record.

-If no sound is playing, the unit may be in Vinyl Stream mode

The record will stop spinning automatically when playback is complete.

To stop manually, lift the tone arm from the record and return it to the rest.

VINYL STREAM™



VINYL STREAM: Playing a Vinyl record on a external Bluetooth speaker or headphones.

Simply turn the Function Knob to the “” to place in Vinyl Stream mode (the dial will flash white).

Turn ON your external Bluetooth speaker or headphone, and set to pairing mode.

Wait a few seconds for the unit to find your device.

The unit will illuminate solid white.

Use your external device to control the volume.

Note: *-We recommend placing the Bluetooth device within 1m (3.3') of the product when initially pairing.*

-Make sure the unit is within 10m (33ft) from your external device for the strongest connection.

-Vinyl Stream is only compatible with vinyl record playback.

-The product stays in the pairing mode for 30 seconds. If pairing is not properly completed, follow the above steps again from the beginning after turning all devices OFF.

CARTRIDGE REPLACEMENT

REPLACEMENT CARTRIDGE: VICTROLA VPC-190

The VPC-190 Cartridge is rated in excess of 1000 hours of normal use. As soon as you notice a change in sound quality or damage to the stylus, it is recommended that it be changed.

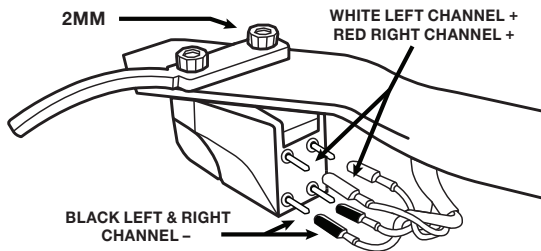

1. Unplug the unit and put the needle cover on the old cartridge.
2. Carefully remove all the wire leads from the back of the old cartridge.
3. Loosen the 2 allen head screws with the included 2mm hex keys on the top of the tone arm / cartridge. Remove old cartridge.
4. Mount the new cartridge, and adjust the position to ensure it will track parallel to the record grooves and tighten the screws.
5. Connect the wire leads to the new cartridge by pushing them firmly on to the connector pins.

WHITE	Left channel positive	(L+)
RED	Right channel positive	(R+)
BLACK	Left and Right channel negative	(L- & R-)

For best results, use a cartridge alignment protractor or download our Cartridge Alignment Protractor at victrola.com/cartridgealignment

SPECIFICATIONS

GENERAL

Power Requirements	AC 100-240V~50/60HZ
Power Consumption	6 W
Dimensions (W x D x H)	350mm x 420mm x 120mm (approx)
Weight	4.81 kgs

RECORD PLAYER

Motor	DC servo motor
Drive System	Belt Drive
Speeds	Off/33-1/3 rpm, 45 rpm
Cartridge Type	Moving Magnetic Cartridge
Moving Magnetic Cartridge	Victrola VPC-190

BLUETOOTH

Bluetooth Version	Bluetooth V5.0
Bluetooth Profiles	A2DP, AVRCP
Bluetooth Frequency range	2.402GHz-2.480GHz
Operating Distance	10 meters (33 ft.)

INCLUDED:

T1 Turntable & Dust Cover, 45 RPM Adapter, Silicone Slipmat, RCA Cable, Power Cable, Instruction Manual, Quick Setup Guide, 2mm/2.5mm hex key, Dust Cover Hinges

WARNING

Important Safety Instruction

1. Read these instructions – All the safety and operating instructions should be read before this product is operated.
2. Keep these instructions – The safety and operating instructions should be retained for future reference.
3. Heed all warnings – All warnings on the appliance and in the operating instructions should be adhered to.
4. Follow all instructions – All operating and use instructions should be followed.
5. Do not use this apparatus near water – The appliance should not be used near water or moisture – for example, in a wet basement or near a swimming pool, and the like.
6. Clean only with dry cloth.
7. Do not block any ventilation openings. Install in accordance with the manufacture's instructions.
8. Do not install near any heat sources such as radiators, heat registers, stoves, or other apparatus (including amplifiers) that produce heat.
9. Protect the power cord from being walked on or pinched particularly at the plugs, convenience receptacles, and at the point where they exit from the apparatus.
10. Only use attachments/accessories specified by the manufacturer.
11. Use only with the cart, stand, tripod, bracket, or table specified by the manufacturer, or sold with the apparatus. When a cart is used, use caution when moving the cart/apparatus combination to avoid injury from tip-over. 
12. Unplug the apparatus during lightning storms or when unused for long periods of time.
13. Refer all servicing to qualified personnel. Servicing is required when the apparatus has been damaged in any way, such as power supply cord or plug is damaged, liquid has been spilled or objects have fallen into the apparatus has been exposed to rain or moisture, does not operate normally, or has been dropped.



CAUTION/ATTENTION:
RISK OF ELECTRIC SHOCK. DO NOT
OPEN. / ATTENTION RISQUE DE
CHOC ELECTRIQUE. NE PAS OUVRIR



14. This lightning flash with arrowhead symbol within an equilateral triangle is intended to alert the user to the presence of non-insulated “dangerous voltage” within the product’s enclosure that may be of sufficient magnitude to constitute a risk of electric shock.
 - a. Warning: To reduce the risk of electric shock, do not remove cover (or back) as there are no user-serviceable parts inside. Refer servicing to qualified personnel.
 - b. The exclamation point within an equilateral triangle is intended to alert the user to the presence of important operating and maintenance instructions in the literature accompanying the appliance.
15.  This equipment is a Class II or double insulated electrical appliance. It has been designed in such a way that it does not require a safety connection to electrical earth.
16. The mains plug is used as disconnect device, the disconnect device shall remain readily operable.
17. **WARNING:** To reduce the risk of fire or electric shock, do not expose this apparatus to rain or moisture. The apparatus shall not be exposed to dripping or splashing and that no objects filled with liquids, such as vases, shall not be placed on apparatus.
18. The use of the equipment in moderate climate.
19. **WARNING:** Please refer the information on exterior bottom/back enclosure for electrical and safety information before installing or operating the apparatus.
20. The ventilation should not be impeded by covering the ventilation openings with items such as newspaper, table-cloths, curtains etc.
21. No naked flame sources, such as lighted candles, should be placed on the apparatus.
22. Do not install this equipment in a confined space such as a book case or similar unit.

SAFETY INFO

Safety Information

1. In order to shut off power to this product completely, unplug the power cord from the wall outlet. Be sure to unplug the unit if you do not intend to use it for an extended period of time, such as during a vacation.
2. Use of controls, adjustments and performance of procedures other than those specified herein may result in hazardous radiation exposure.
3. To prevent electric shock, match wide blade of plug to wide slot, fully insert.
4. If this product is experience problems during operation, contact qualified service centers, and do not use the product in defective states.

Before Use

1. Choose unit installation location carefully. Avoid placing it in direct sunlight or close to a source of heat. Also avoid locations subject to vibrations and excessive dust, cold or moisture. Keep away from sources that hum, such as transformers or motors.
2. Do not open the cabinet as this may result in damage to the circuitry or electrical shock. If a foreign object should get into the set, contact Customer Service.
3. Be sure not to handle record with dirty fingers. Never play a record that has a crack on the surface.
4. When removing the power plug from the wall outlet, always pull directly on the plug, never pull the cord.
5. To protect the stylus, don't forget to put on the white protective needle cover after use.
6. Do not attempt to clean the unit with chemical solvents as this might damage the finish. Use a clean, dry cloth.
7. In order to shut off the power to this product completely, unplug the power cord from the wall outlet. Be sure to unplug the unit if you do not intend to use it for an extended period of time, such as a vacation.
8. Keep this manual in a safe place for future reference.

FCC STATEMENT

This device complies with Part 15 of the FCC Rules. Operation is subject to the following two conditions: (1) This device may not cause harmful interference, and (2) this device must accept any interference received, including interference that may cause undesired operation.

NOTE: This equipment has been tested and found to comply with the limits for a Class B digital device, pursuant to Part 15 of the FCC Rules. These limits are designed to provide reasonable protection against harmful interference in a residential installation. This equipment generates uses and can radiate radio frequency energy and, if not installed and used in accordance with the instructions, may cause harmful interference to radio communications. However, there is no guarantee that interference will not occur in a particular installation. If this equipment does cause harmful interference to radio or television reception, which can be determined by turning the equipment off and on, the user is encouraged to try to correct the interference by one of the following measures:

- Reorient or relocate the receiving antenna.
- Increase the separation between the equipment and receiver.
- Connect the equipment into an outlet on a circuit different from that to which the receiver is connected.
- Consult the dealer or an experienced radio/TV technician for help.

WARNING: Any changes or modifications not expressly approved by the party responsible for compliance could void the user's authority to operate this equipment.

The device must not be co-located or operating in conjunction with any other antenna or transmitter. To maintain compliance with the FCC's RF exposure guidelines, place the product at least 20cm from nearby persons.

Déclaration d'IC sur l'exposition aux radiations:

Cet équipement est conforme aux limites d'exposition aux radiations définies par le Canada pour des environnements non contrôlés. Cet équipement doit être installé et utilisé à une distance minimum de 20 cm

entre l'antenne et votre corps. Cet émetteur ne doit pas être installé au même endroit ni utilisé avec une autre antenne ou un autre émetteur.

This device complies with RSS247 of Industry Canada. Cet appareil se conforme à RSS247 de Canada d'Industrie. This device complies with Industry Canada license-exempt RSS standard(s). Operation is subject to the following two conditions: (1) this device may not cause interference, and (2) this device must accept any interference, including interference that may cause undesired operation of the device appareils radio exempts de licence. Son fonctionnement est sujet aux deux conditions

Suivantes: (1) le dispositif ne doit pas produire de brouillage préjudiciable, et (2) Ce dispositif doit Accepter tout brouillage reçu, y compris un brouillage susceptible de provoquer un fonctionnement indésirable.

WARRANTY

Victrola is a registered trademark of Innovative Technology Electronics, LLC.

United States

Victrola (Innovative Technology Electronics, LLC) warrants to the original retail purchaser that this product will be free from defective materials and workmanship for one (1) year from the date of purchase, subject to the limitations below. This warranty period is not extended if we replace the product.

To obtain a replacement under the terms of this warranty, you must contact the dealer from which it was purchased with your original receipt. If assistance from the dealer from which it was purchased is impossible, you may contact our customer service for warranty assistance at victrola.com/contact.

Except as limited below, if the product proves defective in either material or workmanship within one (1) year from the date of purchase, Victrola will replace the product at no charge. If the product model is no longer available and cannot be replaced with an identical model, Victrola will issue a merchandise credit for the purchase price to be redeemed at victrola.com.

Limitations:

- This limited warranty does not cover failure of the product arising, in whole or in part, from improper installation, storage, transportation, misuse, abuse, accident, neglect, mishandling, unauthorized repair, modification, or wear from ordinary use or environmental deterioration.
- This limited warranty does not cover cosmetic damage, including paint damage, or consequential damage to other components or premises which may result for any reason from the failure of the product.
- This limited warranty is null and void for products not used in accordance with Victrola's instructions.
- This limited warranty terminates if the original retail purchaser sells or otherwise transfers this product.
- This limited warranty is null and void for defects or damage caused by installation or repair performed by any person or entity other than a Victrola authorized installer or dealer.

This warranty gives you specific legal rights, and you may also have other rights which vary from state to state, jurisdiction to jurisdiction or country to country. All express and implied warranties for the product, including but not limited to any implied warranties of merchantability and fitness for a particular purpose, are limited in time to the term of this warranty. Some states, jurisdictions or countries do not allow the exclusion of certain implied warranties or conditions, or limitations on how long an implied warranty or condition lasts, so this limitation may not apply to you. Victrola's responsibility for malfunctions and defects in hardware is limited to replacement or repair as set forth in this warranty statement. Victrola does not accept liability for special, punitive, consequential or incidental damages or losses, whether direct or indirect, including without limitation, any liability for third party claims against you for damages or losses or for products not being available for use. The maximum liability for which Victrola may be responsible will be no more than the amount you paid for the product that is the subject of the claim. Some states, jurisdictions or countries do not allow the exclusion or limitation of special, indirect, incidental or consequential damages, so the above limitation or exclusion may not apply to you.

Canada and US Territories

The Warranty on this product shall comply with applicable law when sold to a consumer in Canada or a US Territory. To obtain any applicable warranty service, please contact the dealer from which you purchased the product, or the distributor that supplied the product, with your original receipt. If assistance from the dealer from which it was purchased is impossible, you may contact our customer service for warranty assistance at victrola.com/contact.

If this product proves defective in either material or workmanship, Victrola will replace the product at no charge. If the product model is no longer available and cannot be repaired effectively or replaced with an identical model, Victrola at its sole option may replace the unit with a current model of equal or greater value.

Outside the U.S, Canada, and US Territories

The Warranty on this product shall comply with applicable law when sold to a consumer outside of the United States, Canada, and US Territories. To obtain any applicable warranty service, please contact the dealer from which you purchased the product, or the distributor that supplied the product, with your original receipt.